

NTMFD4901NF

Dual N-Channel Power MOSFET with Integrated Schottky

30 V, High Side 18 A / Low Side 30 A, Dual N-Channel SO8FL

Features

- Co-Packaged Power Stage Solution to Minimize Board Space
- Low Side MOSFET with Integrated Schottky
- Minimized Parasitic Inductances
- Optimized Devices to Reduce Power Losses
- These Devices are Pb-Free, Halogen Free/BFR Free and are RoHS Compliant

Applications

- DC-DC Converters
- System Voltage Rails
- Point of Load



ON Semiconductor®

<http://onsemi.com>

V _{(BR)DSS}	R _{DS(ON)} MAX	I _D MAX
Q1 Top FET 30 V	6.5 mΩ @ 10 V	18 A
	10 mΩ @ 4.5 V	
Q2 Bottom FET 30 V	2.35 mΩ @ 10 V	30 A
	3.5 mΩ @ 4.5 V	

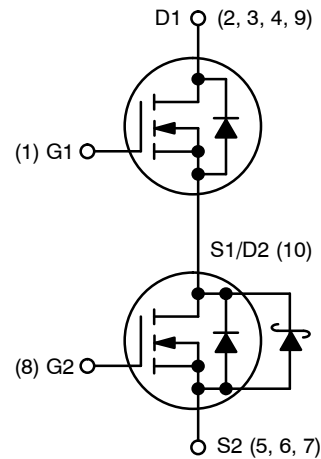

PIN CONNECTIONS

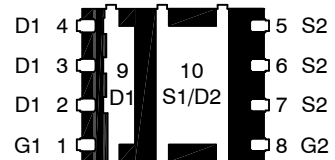

(Bottom View)

MARKING DIAGRAM

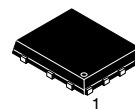

DFN8
CASE 506BX

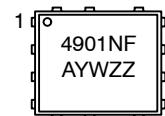

4901NF = Specific Device Code
 A = Assembly Location
 Y = Year
 W = Work Week
 ZZ = Lot Traceability

ORDERING INFORMATION

See detailed ordering and shipping information in the package dimensions section on page 5 of this data sheet.

NTMFD4901NF

MAXIMUM RATINGS ($T_J = 25^\circ\text{C}$ unless otherwise stated)

Parameter			Symbol	Value	Unit			
Drain-to-Source Voltage	Q1		V_{DSS}	30	V			
Drain-to-Source Voltage	Q2							
Gate-to-Source Voltage	Q1		V_{GS}	± 20	V			
Gate-to-Source Voltage	Q2							
Continuous Drain Current $R_{\theta JA}$ (Note 1)		Steady State	Q1	$T_A = 25^\circ\text{C}$	13.5	A		
				$T_A = 85^\circ\text{C}$	9.7			
			Q2	$T_A = 25^\circ\text{C}$	23.4			
				$T_A = 85^\circ\text{C}$	16.9			
Power Dissipation $R_{\theta JA}$ (Note 1)			Q1	$T_A = 25^\circ\text{C}$	P_D	1.90	W	
					Q2	2.07		
Continuous Drain Current $R_{\theta JA} \leq 10$ s (Note 1)		Steady State	Q1	$T_A = 25^\circ\text{C}$	18.2	A		
				$T_A = 85^\circ\text{C}$	13.1			
			Q2	$T_A = 25^\circ\text{C}$	30.3			
				$T_A = 85^\circ\text{C}$	21.8			
Power Dissipation $R_{\theta JA} \leq 10$ s (Note 1)			Q1	$T_A = 25^\circ\text{C}$	P_D	3.45	W	
					Q2	3.45		
Continuous Drain Current $R_{\theta JA}$ (Note 2)		Steady State	Q1	$T_A = 25^\circ\text{C}$	10.3	A		
				$T_A = 85^\circ\text{C}$	7.4			
			Q2	$T_A = 25^\circ\text{C}$	17.9			
				$T_A = 85^\circ\text{C}$	12.9			
Power Dissipation $R_{\theta JA}$ (Note 2)			Q1	$T_A = 25^\circ\text{C}$	P_D	1.10	W	
					Q2	1.20		
Pulsed Drain Current				$T_A = 25^\circ\text{C}$ $t_p = 10 \mu\text{s}$	Q1	I_{DM}	60	A
					Q2	100		
Operating Junction and Storage Temperature	Q1				T_J, T_{STG}	-55 to +150	$^\circ\text{C}$	
	Q2							
Source Current (Body Diode)	Q1				I_S	3.4	A	
	Q2					4.9		
Drain to Source DV/DT					dV/dt	6	V/ns	
Single Pulse Drain-to-Source Avalanche Energy ($T_J = 25^\circ\text{C}$, $V_{DD} = 50$ V, $V_{GS} = 10$ V, $I_L = XX A_{pk}$, $L = 0.1$ mH, $R_G = 25 \Omega$)	24 A	Q1	EAS	28.8	mJ			
	48 A	Q2	EAS	115				
Lead Temperature for Soldering Purposes (1/8" from case for 10 s)			T_L	260	$^\circ\text{C}$			

Stresses exceeding Maximum Ratings may damage the device. Maximum Ratings are stress ratings only. Functional operation above the Recommended Operating Conditions is not implied. Extended exposure to stresses above the Recommended Operating Conditions may affect device reliability.

- Surface-mounted on FR4 board using 1 sq-in pad, 2 oz Cu.
- Surface-mounted on FR4 board using the minimum recommended pad size of 100 mm².

NTMFD4901NF

THERMAL RESISTANCE MAXIMUM RATINGS

Parameter	FET	Symbol	Value	Unit
Junction-to-Ambient – Steady State (Note 3)	Q1	R _{θJA}	65.9	°C/W
	Q2		60.5	
Junction-to-Ambient – Steady State (Note 4)	Q1	R _{θJA}	113.2	
	Q2		104	
Junction-to-Ambient – (t ≤ 10 s) (Note 3)	Q1	R _{θJA}	36.2	
	Q2		36.2	

3. Surface-mounted on FR4 board using 1 sq-in pad, 2 oz Cu.

4. Surface-mounted on FR4 board using the minimum recommended pad size of 100 mm².

ELECTRICAL CHARACTERISTICS (T_J = 25°C unless otherwise specified)

Parameter	FET	Symbol	Test Condition	Min	Typ	Max	Unit
OFF CHARACTERISTICS							
Drain-to-Source Break-down Voltage	Q1	V _{(BR)DSS}	V _{GS} = 0 V, I _D = 250 μA	30			V
	Q2		V _{GS} = 0 V, I _D = 1 mA	30			
Drain-to-Source Break-down Voltage Temperature Coefficient	Q1	V _{(BR)DSS} / T _J			18		mV / °C
	Q2				15		
Zero Gate Voltage Drain Current	Q1	I _{DSS}	V _{GS} = 0 V, V _{DS} = 24 V	T _J = 25°C		1	μA
				T _J = 125°C		10	
	Q2		V _{GS} = 0 V, V _{DS} = 24 V	T _J = 25°C		500	
Gate-to-Source Leakage Current	Q1	I _{GSS}	V _{GS} = 0 V, V _{DS} = ±20 V			±100	nA
	Q2					±100	

ON CHARACTERISTICS (Note 5)

Gate Threshold Voltage	Q1	V _{GS(TH)}	V _{GS} = V _{DS} , I _D = 250 μA	1.2		2.2	V
	Q2			1.2		2.2	
Negative Threshold Temperature Coefficient	Q1	V _{GS(TH)} / T _J			4.5		mV / °C
	Q2				4.0		
Drain-to-Source On Resistance	Q1	R _{DS(on)}	V _{GS} = 10 V	I _D = 10 A	5.2	6.5	mΩ
			V _{GS} = 4.5 V	I _D = 10 A	8.0	10	
	Q2		V _{GS} = 10 V	I _D = 20 A	1.9	2.35	
			V _{GS} = 4.5 V	I _D = 20 A	2.8	3.5	
Forward Transconductance	Q1	g _{FS}	V _{DS} = 1.5 V, I _D = 10 A		28		S
	Q2				45		

CHARGES, CAPACITANCES & GATE RESISTANCE

Input Capacitance	Q1	C _{ISS}	V _{GS} = 0 V, f = 1 MHz, V _{DS} = 15 V		1150		pF
	Q2				2950		
Output Capacitance	Q1	C _{OSS}			360		
	Q2				1100		
Reverse Capacitance	Q1	C _{RSS}			105		
	Q2				82		

5. Pulse Test: pulse width ≤ 300 μs, duty cycle ≤ 2%.

6. Switching characteristics are independent of operating junction temperatures.

NTMFD4901NF

ELECTRICAL CHARACTERISTICS ($T_J = 25^\circ\text{C}$ unless otherwise specified)

Parameter	FET	Symbol	Test Condition	Min	Typ	Max	Unit
-----------	-----	--------	----------------	-----	-----	-----	------

CHARGES, CAPACITANCES & GATE RESISTANCE

Total Gate Charge	Q1	$Q_{G(TOT)}$	$V_{GS} = 4.5\text{ V}, V_{DS} = 15\text{ V}; I_D = 10\text{ A}$		9.7		nC		
	Q2				20				
Threshold Gate Charge	Q1	$Q_{G(TH)}$			1.1				
	Q2				2.7				
Gate-to-Source Charge	Q1	Q_{GS}			3.3				
	Q2				7.3				
Gate-to-Drain Charge	Q1	Q_{GD}			3.7				
	Q2				5.3				
Total Gate Charge	Q1	$Q_{G(TOT)}$		$V_{GS} = 10\text{ V}, V_{DS} = 15\text{ V}; I_D = 10\text{ A}$		19.1			nC
	Q2					42.7			

SWITCHING CHARACTERISTICS (Note 6)

Turn-On Delay Time	Q1	$t_{d(ON)}$	$V_{GS} = 4.5\text{ V}, V_{DS} = 15\text{ V},$ $I_D = 10\text{ A}, R_G = 3.0\ \Omega$		9.0		ns
	Q2				14		
Rise Time	Q1	t_r			15		
	Q2				16		
Turn-Off Delay Time	Q1	$t_{d(OFF)}$			14		
	Q2				25		
Fall Time	Q1	t_f			4.0		
	Q2				7.0		

SWITCHING CHARACTERISTICS (Note 6)

Turn-On Delay Time	Q1	$t_{d(ON)}$	$V_{GS} = 10\text{ V}, V_{DS} = 15\text{ V},$ $I_D = 10\text{ A}, R_G = 3.0\ \Omega$		6.0		ns
	Q2				10		
Rise Time	Q1	t_r			14		
	Q2				15		
Turn-Off Delay Time	Q1	$t_{d(OFF)}$			17		
	Q2				32		
Fall Time	Q1	t_f			3.0		
	Q2				5.0		

DRAIN-SOURCE DIODE CHARACTERISTICS

Forward Voltage	Q1	V_{SD}	$V_{GS} = 0\text{ V},$ $I_S = 3\text{ A}$	$T_J = 25^\circ\text{C}$		0.75	1.0	V
				$T_J = 125^\circ\text{C}$		0.62		
	Q2		$V_{GS} = 0\text{ V},$ $I_S = 2\text{ A}$	$T_J = 25^\circ\text{C}$		0.45	0.70	
				$T_J = 125^\circ\text{C}$		0.37		

5. Pulse Test: pulse width $\leq 300\ \mu\text{s}$, duty cycle $\leq 2\%$.

6. Switching characteristics are independent of operating junction temperatures.

NTMFD4901NF

ELECTRICAL CHARACTERISTICS ($T_J = 25^\circ\text{C}$ unless otherwise specified)

Parameter	FET	Symbol	Test Condition	Min	Typ	Max	Unit
DRAIN-SOURCE DIODE CHARACTERISTICS							
Reverse Recovery Time	Q1	t_{RR}	$V_{GS} = 0\text{ V}, d_{IS}/d_t = 100\text{ A}/\mu\text{s}, I_S = 3\text{ A}$		23		ns
	Q2				40		
Charge Time	Q1	t_a			12		
	Q2				21		
Discharge Time	Q1	t_b			11		
	Q2				19		
Reverse Recovery Charge	Q1	Q_{RR}			12		nC
	Q2				40		

PACKAGE PARASITIC VALUES

Source Inductance	Q1	L_S	$T_A = 25^\circ\text{C}$		0.38		nH
	Q2				0.65		
Drain Inductance	Q1	L_D			0.054		nH
	Q2				0.007		
Gate Inductance	Q1	L_G			1.5		nH
	Q2				1.5		
Gate Resistance	Q1	R_G			0.8		Ω
	Q2				0.8		

5. Pulse Test: pulse width $\leq 300\ \mu\text{s}$, duty cycle $\leq 2\%$.

6. Switching characteristics are independent of operating junction temperatures.

ORDERING INFORMATION

Device	Package	Shipping [†]
NTMFD4901NFT1G	DFN8 (Pb-Free)	1500 / Tape & Reel

[†]For information on tape and reel specifications, including part orientation and tape sizes, please refer to our Tape and Reel Packaging Specifications Brochure, BRD8011/D.

TYPICAL CHARACTERISTICS – Q1

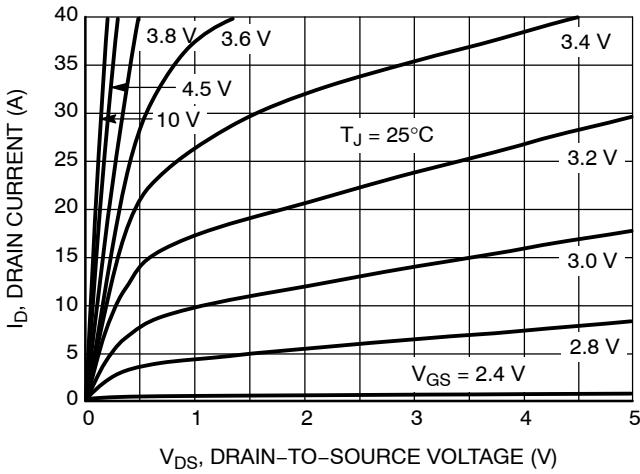

Figure 1. On-Region Characteristics

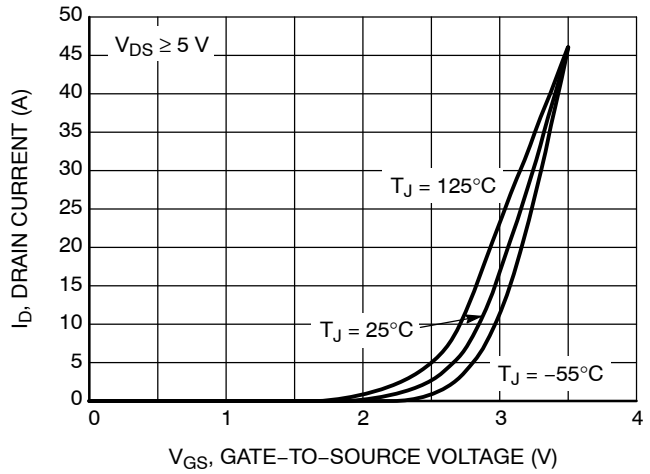

Figure 2. Transfer Characteristics

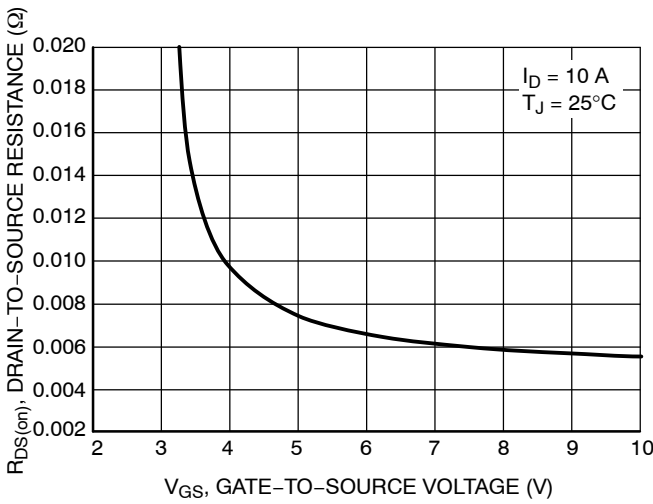

Figure 3. On-Resistance vs. Gate-to-Source Resistance

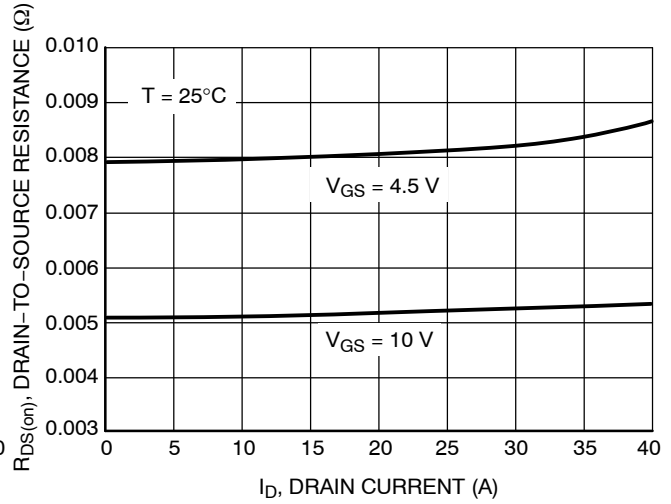

Figure 4. On-Resistance vs. Drain Current and Gate Voltage

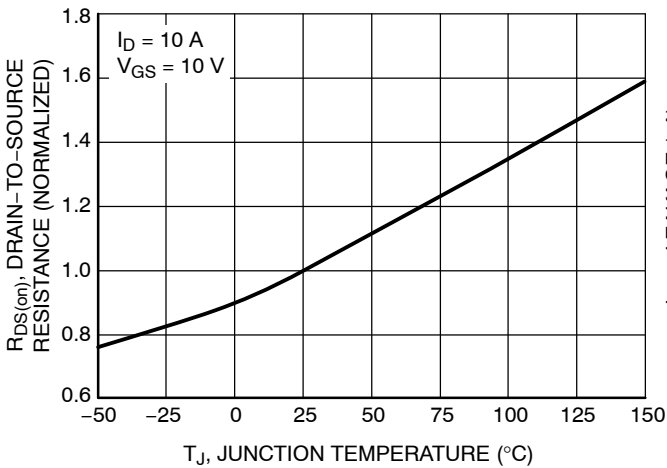

Figure 5. On-Resistance Variation with Temperature

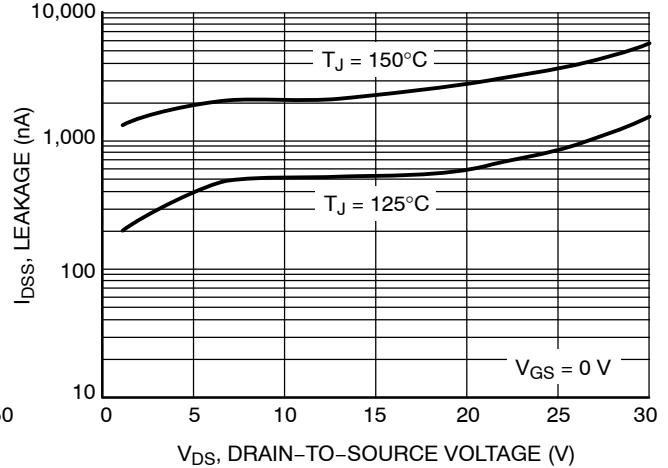

Figure 6. Drain-to-Source Leakage Current vs. Voltage

NTMFD4901NF

TYPICAL CHARACTERISTICS – Q1

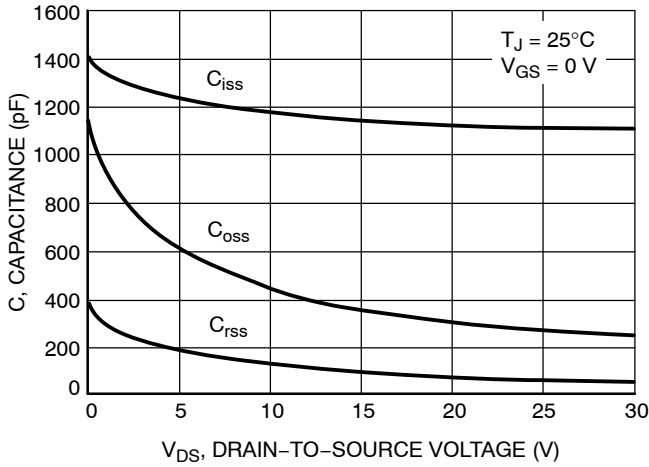

Figure 7. Capacitance Variation

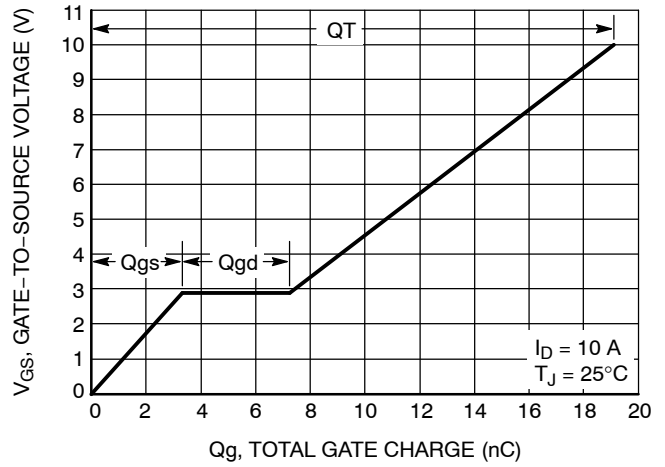

Figure 8. Gate-to-Source and Drain-to-Source Voltage vs. Total Charge

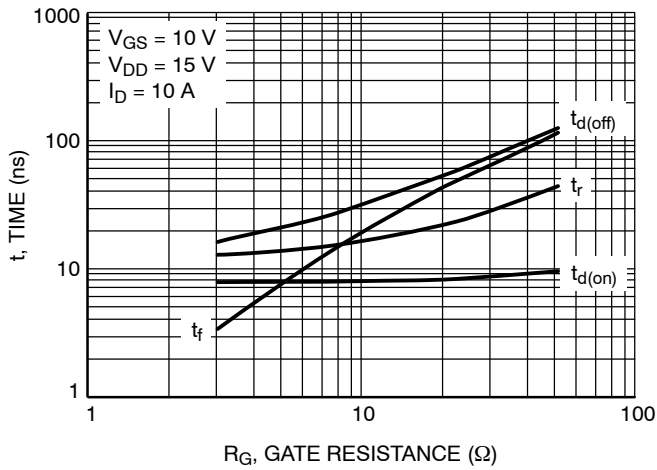

Figure 9. Resistive Switching Time Variation vs. Gate Resistance

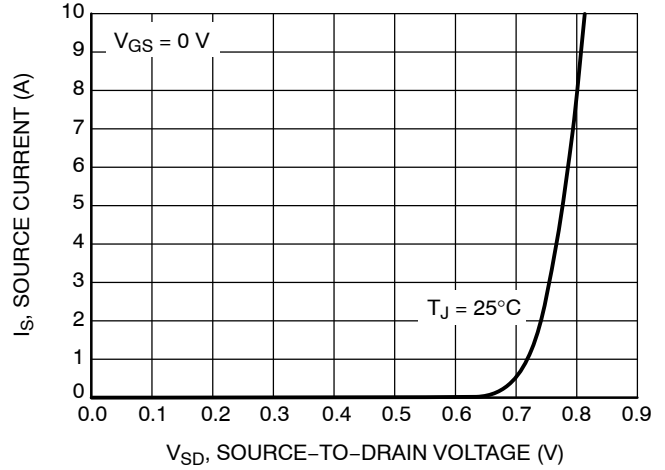

Figure 10. Diode Forward Voltage vs. Current

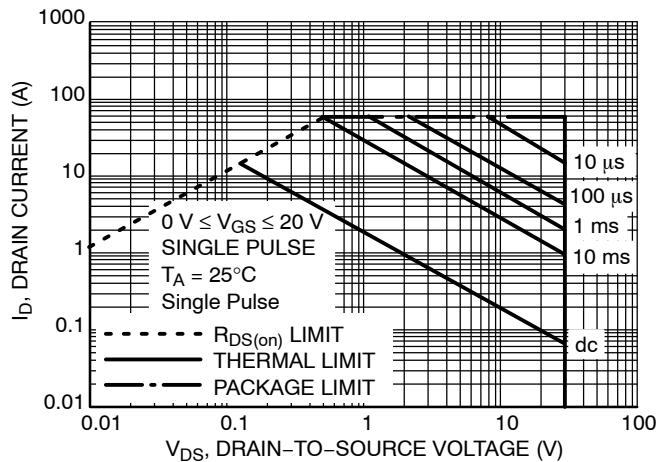

Figure 11. Maximum Rated Forward Biased Safe Operating Area

NTMFD4901NF

TYPICAL CHARACTERISTICS – Q1

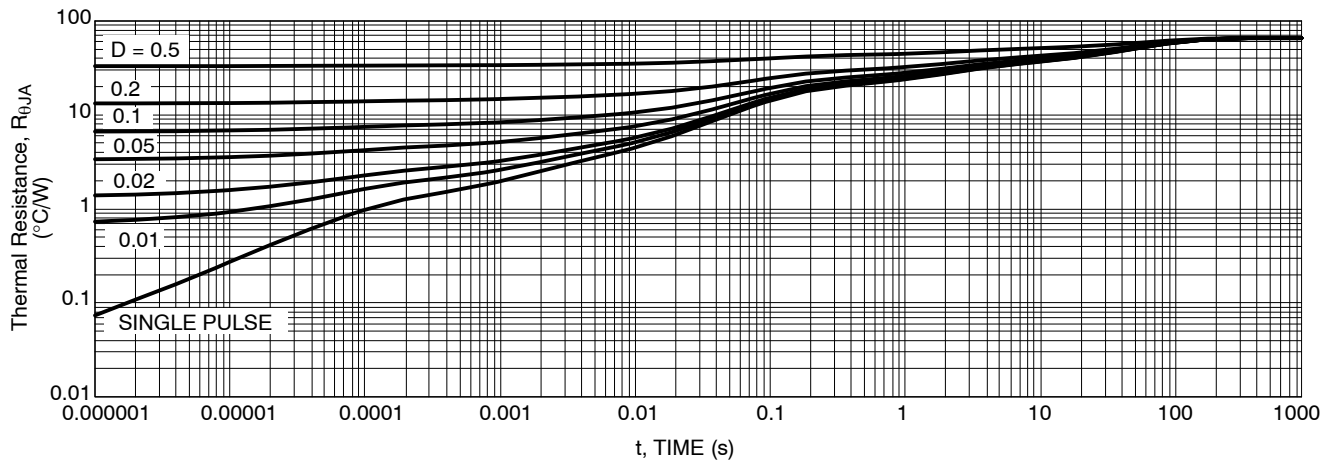

Figure 12. Thermal Response

TYPICAL CHARACTERISTICS – Q2

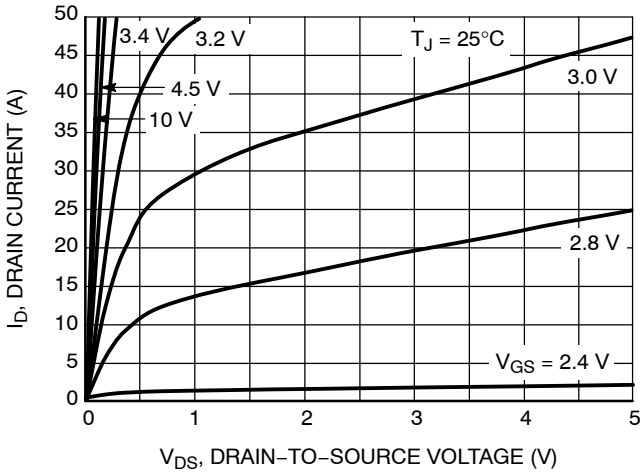

Figure 13. On-Region Characteristics

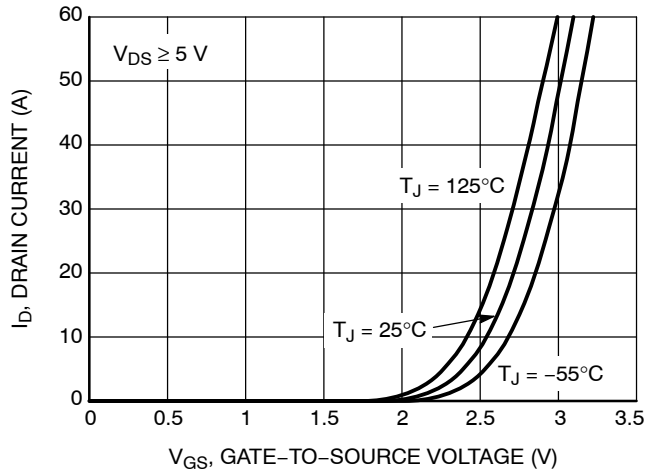

Figure 14. Transfer Characteristics

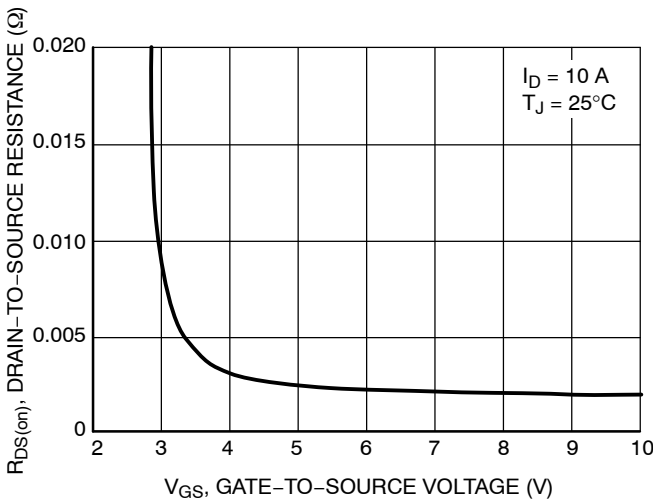

Figure 15. On-Resistance vs. Gate-to-Source Resistance

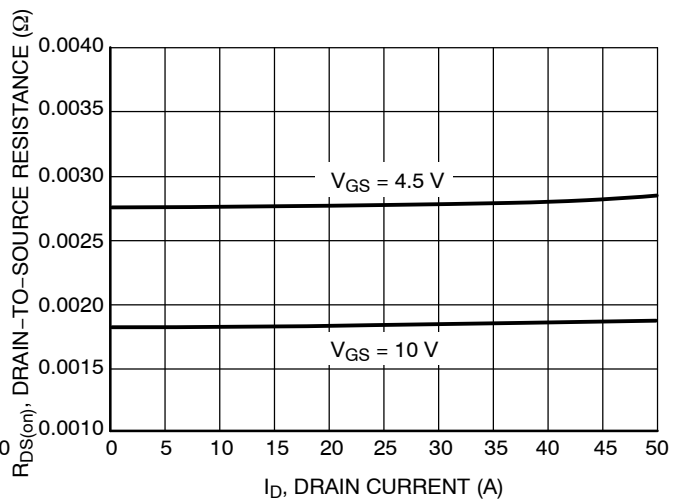

Figure 16. On-Resistance vs. Drain Current and Gate Voltage

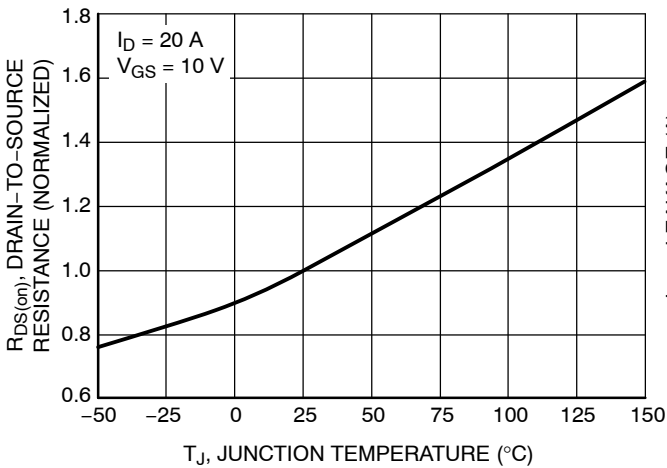

Figure 17. On-Resistance Variation with Temperature

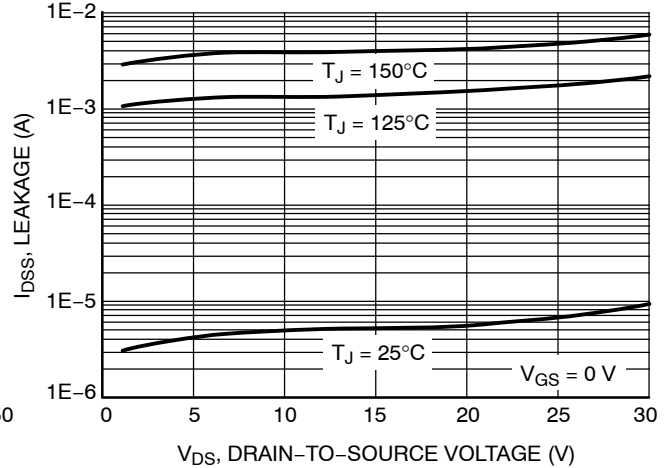

Figure 18. Drain-to-Source Leakage Current vs. Voltage

NTMFD4901NF

TYPICAL CHARACTERISTICS – Q2

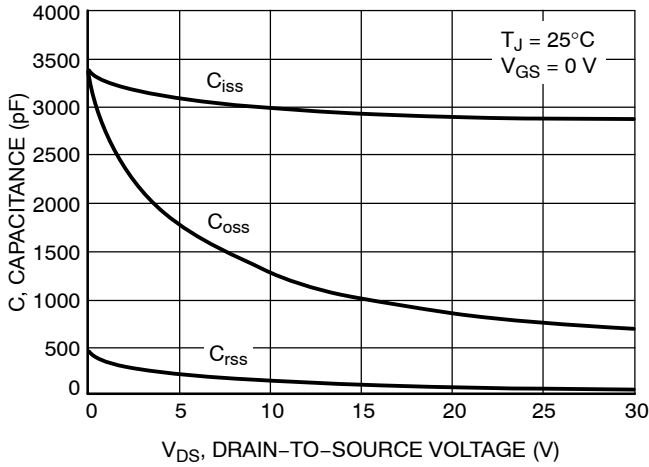

Figure 19. Capacitance Variation

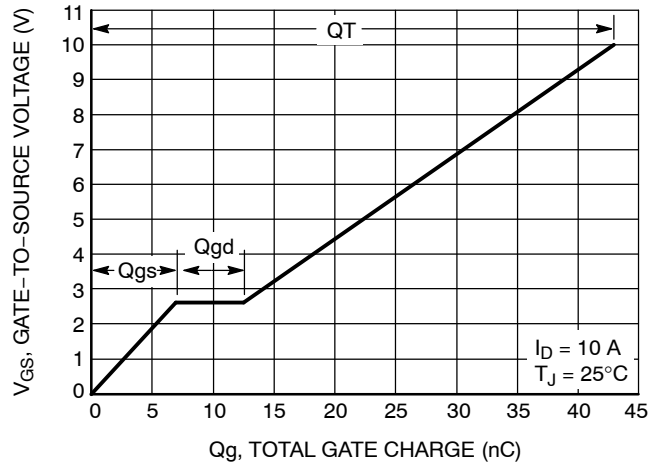

Figure 20. Gate-to-Source and Drain-to-Source Voltage vs. Total Charge

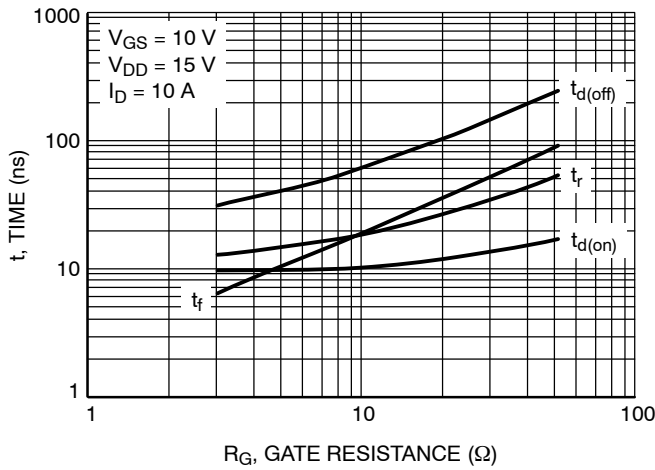

Figure 21. Resistive Switching Time Variation vs. Gate Resistance

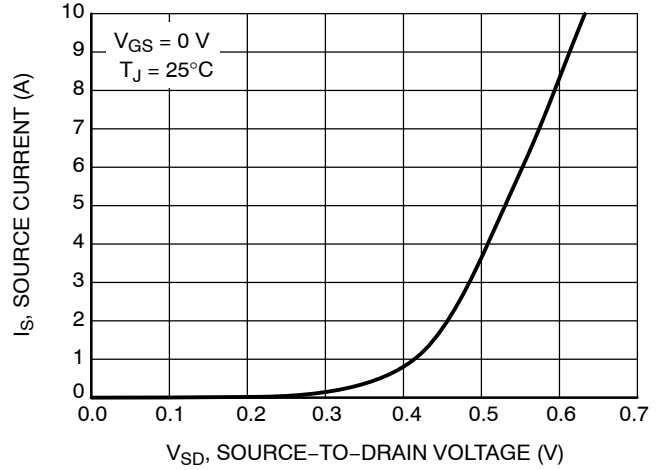

Figure 22. Diode Forward Voltage vs. Current

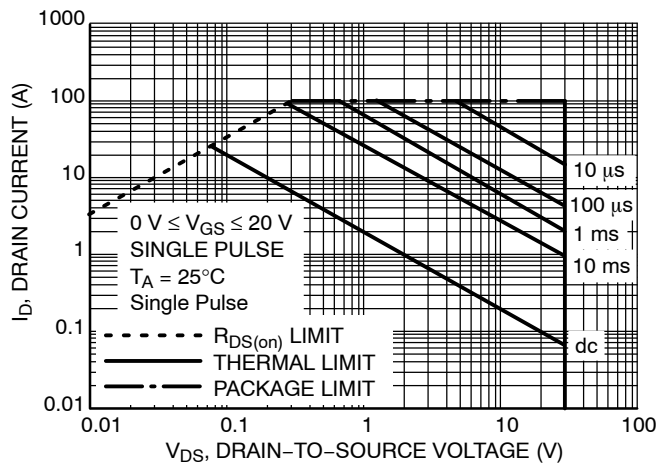

Figure 23. Maximum Rated Forward Biased Safe Operating Area

NTMFD4901NF

TYPICAL CHARACTERISTICS – Q2

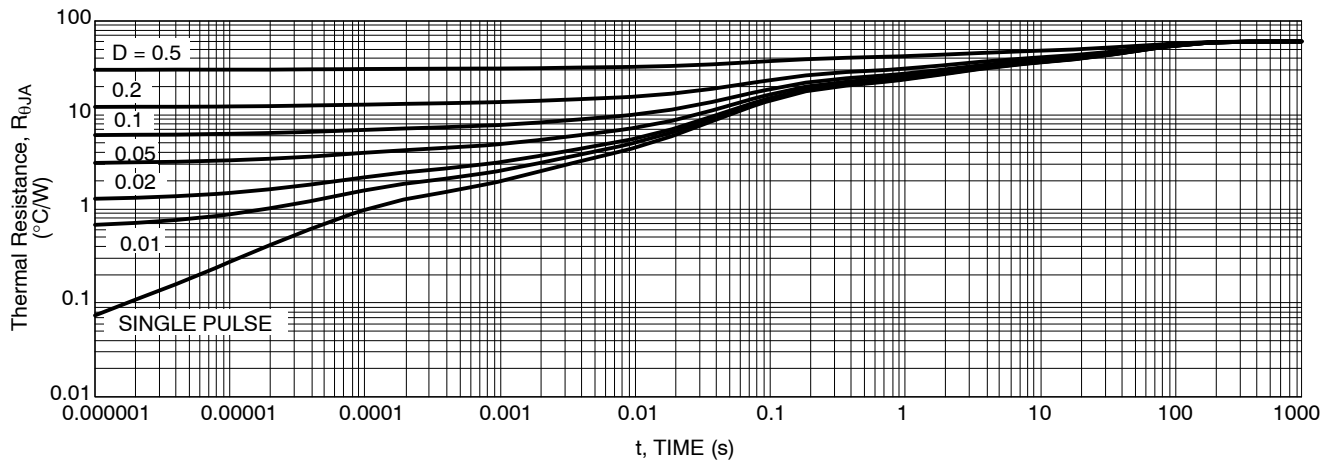
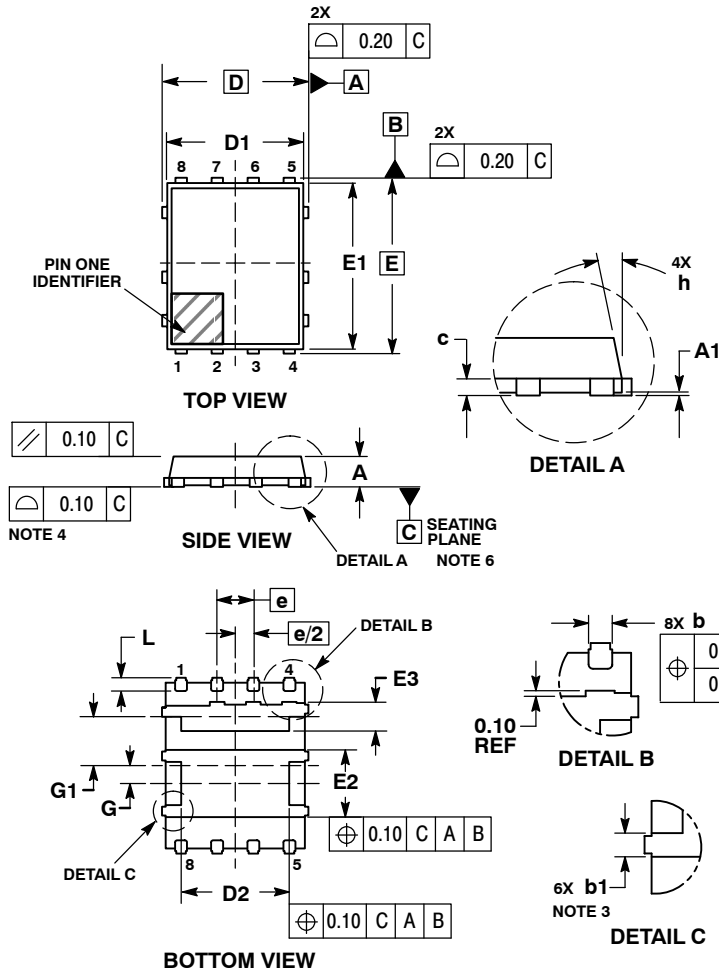

Figure 24. Thermal Response

NTMFD4901NF

PACKAGE DIMENSIONS

DFN8 5x6, 1.27P Dual Flag (SO8FL-Dual-Asymmetrical) CASE 506BX ISSUE C



NOTES:

1. DIMENSIONING AND TOLERANCING PER ASME Y14.5M, 1994.
2. CONTROLLING DIMENSION: MILLIMETERS.
3. DIMENSIONS b AND b1 APPLY TO PLATED FEATURES AND ARE MEASURED BETWEEN 0.15 AND 0.25 MM FROM TERMINAL TIPS.
4. COPLANARITY APPLIES TO THE EXPOSED PADS AS WELL AS THE TERMINALS.
5. DIMENSIONS D1 AND E1 DO NOT INCLUDE MOLD FLASH, PROTRUSIONS, OR GATE BURRS.
6. SEATING PLANE IS DEFINED BY THE TERMINALS. A1 IS DEFINED AS THE DISTANCE FROM THE SEATING PLANE TO THE LOWEST POINT ON THE PACKAGE BODY.

DIM	MILLIMETERS	
	MIN	MAX
A	0.90	1.10
A1	0.00	0.05
b	0.41	0.61
b1	0.41	0.61
c	0.23	0.33
D	5.15 BSC	
D1	4.50	5.10
D2	3.50	4.22
E	6.15 BSC	
E1	5.50	6.10
E2	2.27	2.67
E3	0.82	1.22
e	1.27 BSC	
G	0.63 BSC	
G1	1.72 BSC	
h	---	12 °
L	0.35	0.55

RECOMMENDED SOLDERING FOOTPRINT*

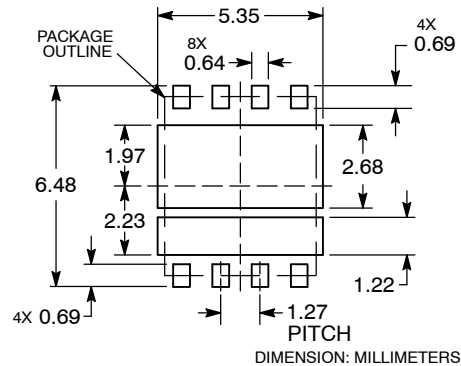

*For additional information on our Pb-Free strategy and soldering details, please download the ON Semiconductor Soldering and Mounting Techniques Reference Manual, SOLDERRM/D.

ON Semiconductor and are registered trademarks of Semiconductor Components Industries, LLC (SCILLC). SCILLC reserves the right to make changes without further notice to any products herein. SCILLC makes no warranty, representation or guarantee regarding the suitability of its products for any particular purpose, nor does SCILLC assume any liability arising out of the application or use of any product or circuit, and specifically disclaims any and all liability, including without limitation special, consequential or incidental damages. "Typical" parameters which may be provided in SCILLC data sheets and/or specifications can and do vary in different applications and actual performance may vary over time. All operating parameters, including "Typicals" must be validated for each customer application by customer's technical experts. SCILLC does not convey any license under its patent rights nor the rights of others. SCILLC products are not designed, intended, or authorized for use as components in systems intended for surgical implant into the body, or other applications intended to support or sustain life, or for any other application in which the failure of the SCILLC product could create a situation where personal injury or death may occur. Should Buyer purchase or use SCILLC products for any such unintended or unauthorized application, Buyer shall indemnify and hold SCILLC and its officers, employees, subsidiaries, affiliates, and distributors harmless against all claims, costs, damages, and expenses, and reasonable attorney fees arising out of, directly or indirectly, any claim of personal injury or death associated with such unintended or unauthorized use, even if such claim alleges that SCILLC was negligent regarding the design or manufacture of the part. SCILLC is an Equal Opportunity/Affirmative Action Employer. This literature is subject to all applicable copyright laws and is not for resale in any manner.

PUBLICATION ORDERING INFORMATION

LITERATURE FULFILLMENT:
Literature Distribution Center for ON Semiconductor
P.O. Box 5163, Denver, Colorado 80217 USA
Phone: 303-675-2175 or 800-344-3860 Toll Free USA/Canada
Fax: 303-675-2176 or 800-344-3867 Toll Free USA/Canada
Email: orderlit@onsemi.com

N. American Technical Support: 800-282-9855 Toll Free
USA/Canada
Europe, Middle East and Africa Technical Support:
Phone: 421 33 790 2910
Japan Customer Focus Center
Phone: 81-3-5817-1050

ON Semiconductor Website: www.onsemi.com
Order Literature: <http://www.onsemi.com/orderlit>

For additional information, please contact your local Sales Representative