

DELPHI SERIES



FEATURES

- ♦ High efficiency: 90.5% @ 12V/5A
- ♦ Size:
 - 58.4x22.8x9.8mm (2.30"x0.90"x0.39") (W/O heat-spreader)
 - 58.4mm x 22.8mm x 12.7mm (2.30"x0.90"x0.5") (With heat-spreader)
- ♦ Standard footprint
- ♦ Industry standard pin out
- ♦ Fixed frequency operation
- ♦ Input UVLO, Output OCP, OVP, OTP
- ♦ 1500V isolation and basic insulation
- ♦ ISO 9001, TL 9000, ISO 14001, QS9000, OHSAS18001 certified manufacturing facility
- ♦ UL/cUL 60950-1 (US & Canada) recognized

Delphi E36SR Series DC/DC Power Modules: 18~75 in, 12V/5A out, 60W

The Delphi E36SR series, Eighth brick sized, 24V/48V input, single output, isolated DC/DC converter, is the latest offering from a world leader in power system technology and manufacturing — Delta Electronics, Inc. The E36SR12V provides up to 60 watts of power in an industry standard footprint and pinout. With creative design technology and optimization of component placement, these converters possess outstanding electrical and thermal performances, as well as extremely high reliability under highly stressful operating conditions. All models are fully protected from abnormal input/output voltage, current, and temperature conditions. The Delphi Series converters meet all safety requirements with basic insulation.

OPTIONS

- ♦ Positive On/Off logic
- ♦ Heat spreader

APPLICATIONS

- ♦ Telecom/Datacom
- ♦ Wireless Networks
- ♦ Optical Network Equipment
- ♦ Server and Data Storage
- ♦ Industrial/Test Equipment

TECHNICAL SPECIFICATIONS

($T_A=25^{\circ}\text{C}$, airflow rate=300 LFM, $V_{in}=24/48\text{Vdc}$, nominal V_{out} unless otherwise noted.)

PARAMETER	NOTES and CONDITIONS	E36SR12005NKFA			
		Min.	Typ.	Max.	Units
ABSOLUTE MAXIMUM RATINGS					
Input Voltage					
Continuous				80	Vdc
Transient (100ms)	100ms			100	Vdc
Operating Ambient Temperature		-40		85	$^{\circ}\text{C}$
Storage Temperature		-55		125	$^{\circ}\text{C}$
Input/Output Isolation Voltage				1500	Vdc
INPUT CHARACTERISTICS					
Operating Input Voltage		18		75	Vdc
Input Under-Voltage Lockout					
Turn-On Voltage Threshold		16	17	18	Vdc
Turn-Off Voltage Threshold		14	15	16	Vdc
Lockout Hysteresis Voltage		1	2	3	Vdc
Maximum Input Current	100% Load, 18Vin			4.5	A
No-Load Input Current			60		mA
Off Converter Input Current			6		mA
Inrush Current (I^2t)				1	A^2s
Input Reflected-Ripple Current	P-P thru 12 μH inductor, 5Hz to 20MHz		20		mA
Input Voltage Ripple Rejection	120 Hz		50		dB
OUTPUT CHARACTERISTICS					
Output Voltage Set Point	$V_{in}=48\text{V}$, $I_o=I_{o,max}$, $T_c=25^{\circ}\text{C}$	11.820	12.000	12.240	Vdc
Output Voltage Regulation					
Over Load	$I_o=I_{o,min}$ to $I_{o,max}$		± 24	± 48	mV
Over Line	$V_{in}=18\text{V}$ to 60V		± 24	± 48	mV
Over Temperature	$T_c=-40^{\circ}\text{C}$ to 85°C			± 180	mV
Total Output Voltage Range	Over sample load, line and temperature	11.8		12.2	Vdc
Output Voltage Ripple and Noise					
5Hz to 20MHz bandwidth					
Peak-to-Peak	Full Load, 1 μF ceramic, 10 μF tantalum		50	100	mV
RMS	Full Load, 1 μF ceramic, 10 μF tantalum			25	mV
Operating Output Current Range		0.4		5	A
Output Over Current Protection		6.5		8.5	A
DYNAMIC CHARACTERISTICS					
Output Voltage Current Transient					
48V, 10 μF Tan & 1 μF Ceramic load cap, 0.1A/ μs					
Positive Step Change in Output Current	50% $I_{o,max}$ to 75% $I_{o,max}$		200		mV
Negative Step Change in Output Current	75% $I_{o,max}$ to 50% $I_{o,max}$		200		mV
Settling Time (within 1% V_{out} nominal)			100		us
Turn-On Transient					
Start-Up Time, From On/Off Control				25	ms
Start-Up Time, From Input				25	ms
Maximum Output Capacitance	Full load; 5% overshoot of V_{out} at startup			2000	μF
EFFICIENCY					
100% load	$V_{in}=48\text{v}$		90.5		%
60% load	$V_{in}=48\text{v}$		89		%
ISOLATION CHARACTERISTICS					
Input to Output				1500	Vdc
Isolation Resistance				10	M Ω
Isolation Capacitance			1000		pF
FEATURE CHARACTERISTICS					
Switching Frequency					
ON/OFF Control, Negative Remote On/Off logic			260		kHz
Logic Low (Module On)					
Logic Low (Module On)	$V_{on/off}$ at $I_{on/off}=1.0\text{mA}$	0		0.8	V
Logic High (Module Off)	$V_{on/off}$ at $I_{on/off}=0.0\mu\text{A}$	3		12	V
ON/OFF Control, Positive Remote On/Off logic					
Logic Low (Module Off)	$V_{on/off}$ at $I_{on/off}=1.0\text{mA}$	0		0.8	V
Logic High (Module On)	$V_{on/off}$ at $I_{on/off}=0.0\mu\text{A}$	3.5		12	V
ON/OFF Current (for both remote on/off logic)	$I_{on/off}$ at $V_{on/off}=0.0\text{V}$			1	mA
Leakage Current (for both remote on/off logic)	Logic High, $V_{on/off}=12\text{V}$			50	μA
Output Over-Voltage Protection					
Output Over-Voltage Protection	Over full temp range;	13.2		16.8	V
GENERAL SPECIFICATIONS					
MTBF	$I_o=100\%$ of $I_{o,max}$; $T_a=25^{\circ}\text{C}$, airflow rate=200FLM		1.88		M hours
Weight	Without heat spreader		24.6		Grams
Weight	With heat spreader		36.5		grams
Over-Temperature Shutdown (Without heat spreader)	Refer to Figure 19 for Hot spot 1 location (48Vin,80% I_o , 200LFM,Airflow from Vin- to Vin+)		131		$^{\circ}\text{C}$
Over-Temperature Shutdown (With heat spreader)	Refer to Figure 23 for Hot spot 2 location (48Vin,80% I_o , 200LFM,Airflow from Vin- to Vin+)		115		$^{\circ}\text{C}$
Over-Temperature Shutdown (NTC Resistor)	Refer to Figure 19 for NTC resistor location		122		$^{\circ}\text{C}$
Note: Please attach thermocouple on NTC resistor to test OTP function, the hot spot's temperature is just for reference.					

TECHNICAL SPECIFICATIONS

($T_A=25^{\circ}\text{C}$, airflow rate=300 LFM, $V_{in}=24/48\text{Vdc}$, nominal V_{out} unless otherwise noted.)

PARAMETER	NOTES and CONDITIONS	E36SR12005NKFH			
		Min.	Typ.	Max.	Units
ABSOLUTE MAXIMUM RATINGS					
Input Voltage					
Continuous				80	Vdc
Transient (100ms)	100ms			100	Vdc
Operating Ambient Temperature		-40		85	$^{\circ}\text{C}$
Storage Temperature		-55		125	$^{\circ}\text{C}$
Input/Output Isolation Voltage				1500	Vdc
INPUT CHARACTERISTICS					
Operating Input Voltage		18		75	Vdc
Input Under-Voltage Lockout					
Turn-On Voltage Threshold		16	17	18	Vdc
Turn-Off Voltage Threshold		14	15	16	Vdc
Lockout Hysteresis Voltage		1	2	3	Vdc
Maximum Input Current	100% Load, 18Vin			4.5	A
No-Load Input Current			60		mA
Off Converter Input Current			6		mA
Inrush Current (I^2t)				1	A^2s
Input Reflected-Ripple Current	P-P thru 12 μH inductor, 5Hz to 20MHz		20		mA
Input Voltage Ripple Rejection	120 Hz		50		dB
OUTPUT CHARACTERISTICS					
Output Voltage Set Point	$V_{in}=48\text{V}$, $I_o=I_{o,max}$, $T_c=25^{\circ}\text{C}$	11.820	12.000	12.240	Vdc
Output Voltage Regulation					
Over Load	$I_o=I_{o,min}$ to $I_{o,max}$		± 24	± 48	mV
Over Line	$V_{in}=18\text{V}$ to 60V		± 24	± 48	mV
Over Temperature	$T_c=-40^{\circ}\text{C}$ to 85°C			± 180	mV
Total Output Voltage Range	Over sample load, line and temperature	11.8		12.2	Vdc
Output Voltage Ripple and Noise					
	5Hz to 20MHz bandwidth				
Peak-to-Peak	Full Load, 1 μF ceramic, 10 μF tantalum		50	100	mV
RMS	Full Load, 1 μF ceramic, 10 μF tantalum			25	mV
Operating Output Current Range		0.4		5	A
Output Over Current Protection		6.5		8.5	A
DYNAMIC CHARACTERISTICS					
Output Voltage Current Transient					
	48V, 10 μF Tan & 1 μF Ceramic load cap, 0.1A/ μs				
Positive Step Change in Output Current	50% $I_{o,max}$ to 75% $I_{o,max}$		200		mV
Negative Step Change in Output Current	75% $I_{o,max}$ to 50% $I_{o,max}$		200		mV
Settling Time (within 1% V_{out} nominal)			100		us
Turn-On Transient					
Start-Up Time, From On/Off Control			214	244	ms
Start-Up Time, From Input			214	244	ms
Maximum Output Capacitance	Full load; 5% overshoot of V_{out} at startup			8000	μF
EFFICIENCY					
100% load	$V_{in}=48\text{v}$		90.5		%
60% load	$V_{in}=48\text{v}$		89		%
ISOLATION CHARACTERISTICS					
Input to Output				1500	Vdc
Isolation Resistance				10	M Ω
Isolation Capacitance			2000		pF
FEATURE CHARACTERISTICS					
Switching Frequency					
ON/OFF Control, Negative Remote On/Off logic			260		kHz
Logic Low (Module On)					
Logic Low (Module On)	$V_{on/off}$ at $I_{on/off}=1.0\text{mA}$	0		0.8	V
Logic High (Module Off)	$V_{on/off}$ at $I_{on/off}=0.0\mu\text{A}$	3		12	V
ON/OFF Control, Positive Remote On/Off logic					
Logic Low (Module Off)	$V_{on/off}$ at $I_{on/off}=1.0\text{mA}$	0		0.8	V
Logic High (Module On)	$V_{on/off}$ at $I_{on/off}=0.0\mu\text{A}$	3.5		12	V
ON/OFF Current (for both remote on/off logic)	$I_{on/off}$ at $V_{on/off}=0.0\text{V}$			1	mA
Leakage Current (for both remote on/off logic)	Logic High, $V_{on/off}=12\text{V}$			50	μA
Output Over-Voltage Protection	Over full temp range;	13.2		16.8	V
GENERAL SPECIFICATIONS					
MTBF	$I_o=100\%$ of I_o, max ; $T_a=25^{\circ}\text{C}$, airflow rate=200FLM		1.88		M hours
Weight	Without heat spreader		24.6		Grams
Weight	With heat spreader		36.5		grams
Over-Temperature Shutdown (Without heat spreader)	Refer to Figure 19 for Hot spot 1 location (48Vin,80% I_o , 200LFM,Airflow from Vin- to Vin+)		131		$^{\circ}\text{C}$
Over-Temperature Shutdown (With heat spreader)	Refer to Figure 23 for Hot spot 2 location (48Vin,80% I_o , 200LFM,Airflow from Vin- to Vin+)		115		$^{\circ}\text{C}$
Over-Temperature Shutdown (NTC Resistor)	Refer to Figure 19 for NTC resistor location		122		$^{\circ}\text{C}$
Note: Please attach thermocouple on NTC resistor to test OTP function, the hot spot's temperature is just for reference.					

ELECTRICAL CHARACTERISTICS CURVES

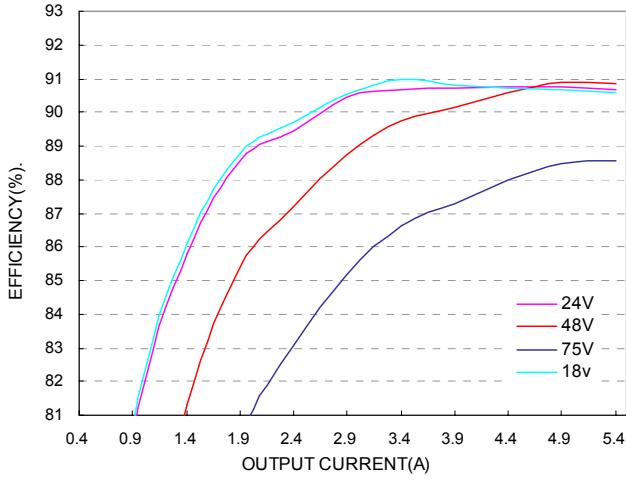

Figure 1: Efficiency vs. load current for minimum, nominal, and maximum input voltage at 25°C, 300LFM airflow.

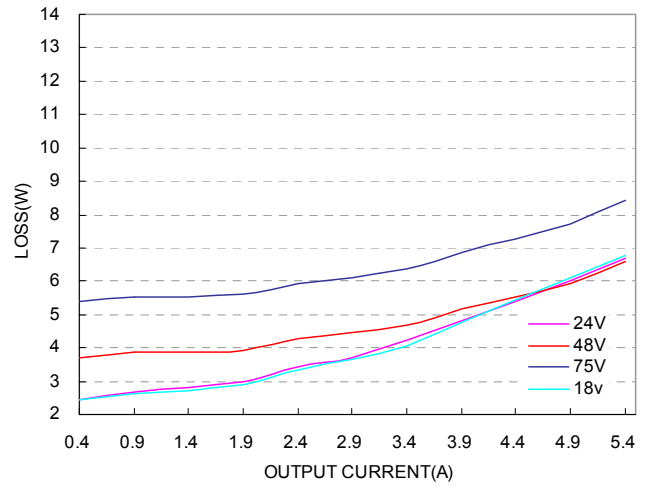

Figure 2: Power dissipation vs. load current for minimum, nominal, and maximum input voltage at 25°C, 300LFM airflow.

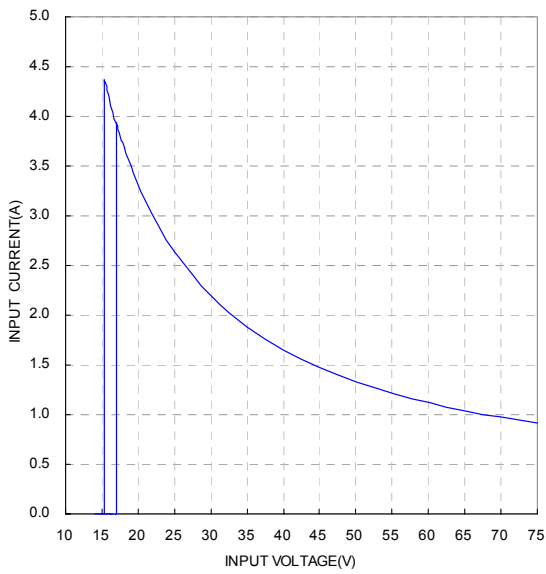

Figure 3: Typical full load input characteristics at 25°C

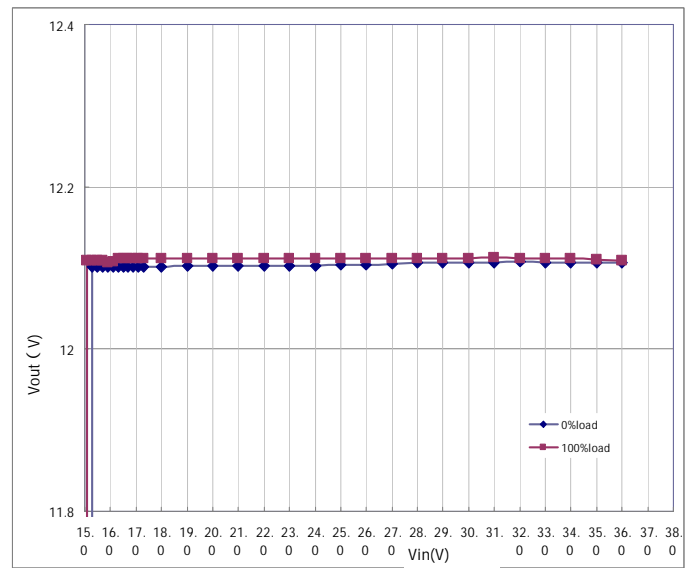

Figure 4: Typical output regulation curve at 25°C

ELECTRICAL CHARACTERISTICS CURVES

For Input Voltage On/Off

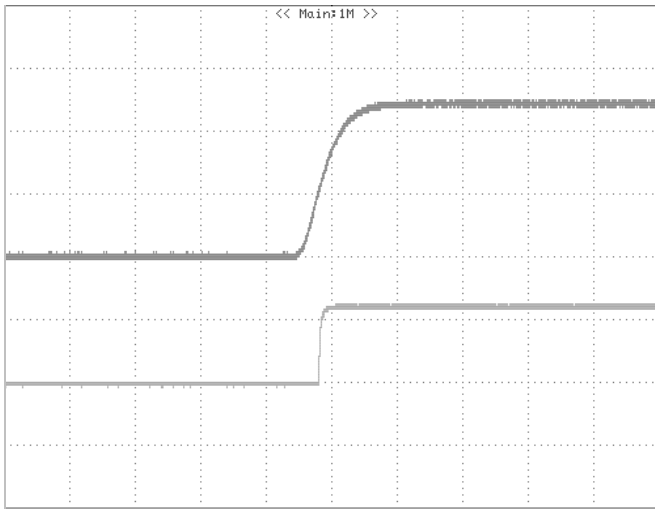

Figure 5: Turn-on transient at full rated load current (100ms/div). $V_{in}=48V$. Top Trace: Input Voltage, 20V/div; Bottom Trace: V_{out} , 10V/div

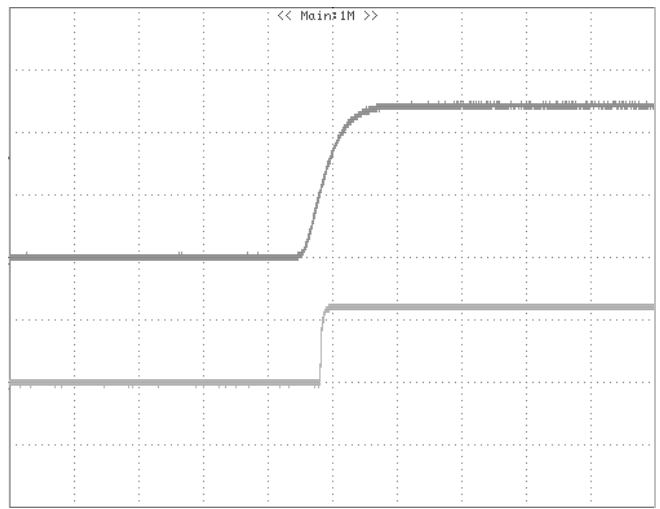

Figure 6: Turn-on transient at min load current (100ms/div). $V_{in}=48V$. Top Trace: Input Voltage, 20V/div; Bottom Trace: V_{out} , 10V/div

For negative On/Off Logic

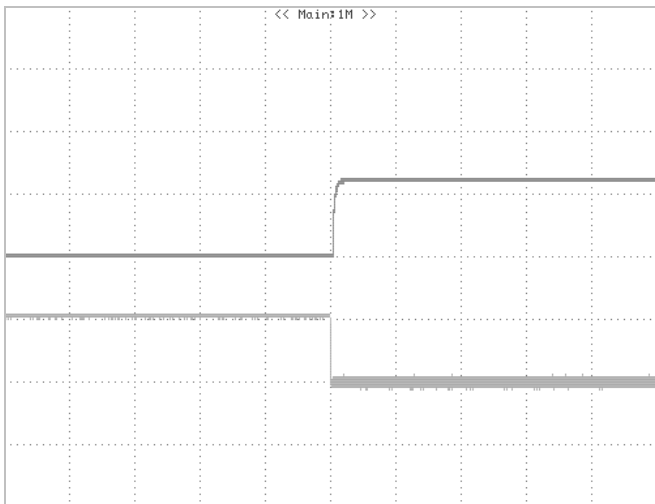

Figure 7: Turn-on transient at full rated load current (100ms/div) for negative on/off mode. $V_{in}=48V$. Top Trace: V_{out} , 10V/div; Bottom Trace: ON/OFF input, 5V/div

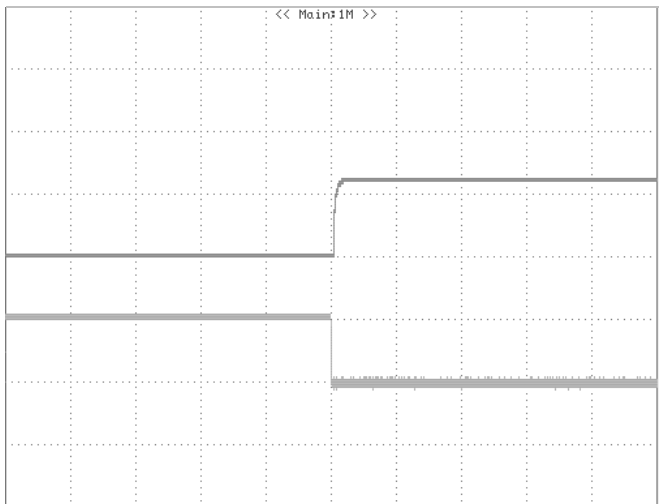

Figure 8: Turn-on transient at min load current (100ms/div) for negative on/off mode. $V_{in}=48V$. Top Trace: V_{out} , 10V/div; Bottom Trace: ON/OFF input, 5V/div

ELECTRICAL CHARACTERISTICS CURVES

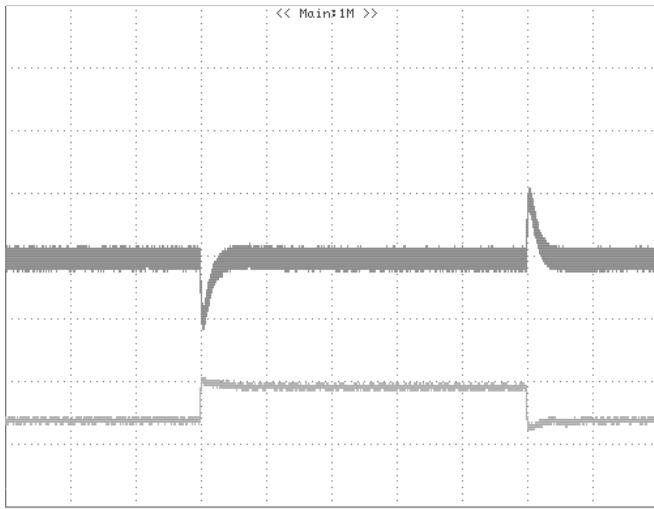

Figure 9: Output voltage response to step-change in load current (75%-50%-75% of I_o , max; $di/dt = 0.01A/\mu s$). Load cap: $10\mu F$ tantalum capacitor and $1\mu F$ ceramic capacitor. Top Trace: V_{out} (0.2V/div, 1ms/div), Bottom Trace: I_{out} (2A/div). Scope measurement should be made using a BNC cable (length shorter than 20 inches). Position the load between 51 mm to 76 mm (2 inches to 3 inches) from the module

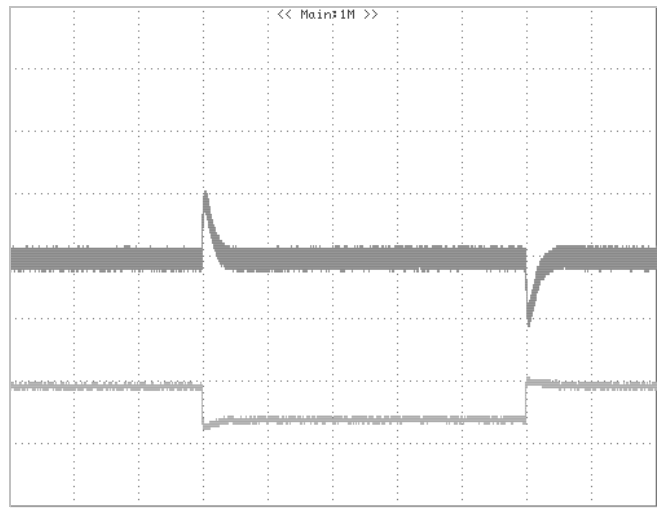

Figure 10: Output voltage response to step-change in load current (75%-50%-75% of I_o , max; $di/dt = 2.5A/\mu s$). Load cap: $47\mu F$, $35m\Omega$ ESR solid electrolytic capacitor and $1\mu F$ ceramic capacitor. Top Trace: V_{out} (0.2 V/div, 1ms/div), Bottom Trace: I_{out} (2A/div). Scope measurement should be made using a BNC cable (length shorter than 20 inches). Position the load between 51 mm to 76 mm (2 inches to 3 inches) from the module

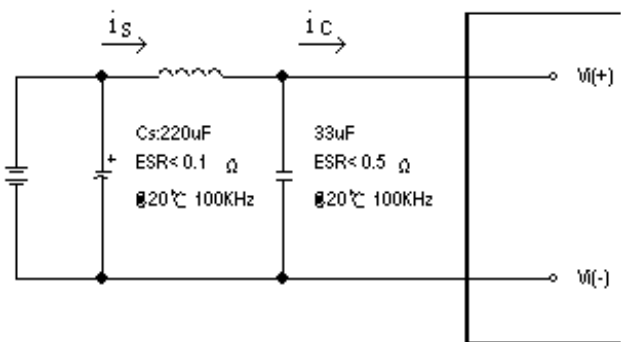

Figure 11: Test set-up diagram showing measurement points for Input Terminal Ripple Current and Input Reflected Ripple Current.

Note: Measured input reflected-ripple current with a simulated source Inductance (L_{TEST}) of $12\mu H$. Capacitor C_s offset possible battery impedance. Measured current as shown below

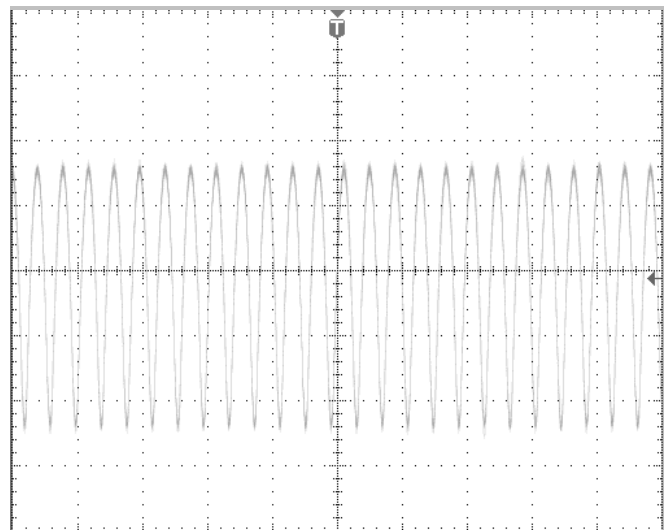

Figure 12: Input Terminal Ripple Current, i_c , at full rated output current and nominal input voltage with $12\mu H$ source impedance and $33\mu F$ electrolytic capacitor (250mA/div, 10us/div)

ELECTRICAL CHARACTERISTICS CURVES

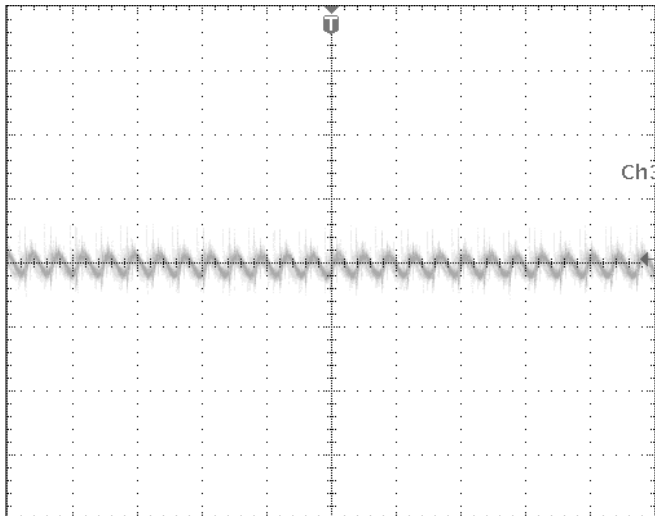

Figure 13: Input reflected ripple current, i_s , through a $12\mu\text{H}$ source inductor at nominal input voltage and rated load current (10 mA/div , $10\mu\text{s/div}$)

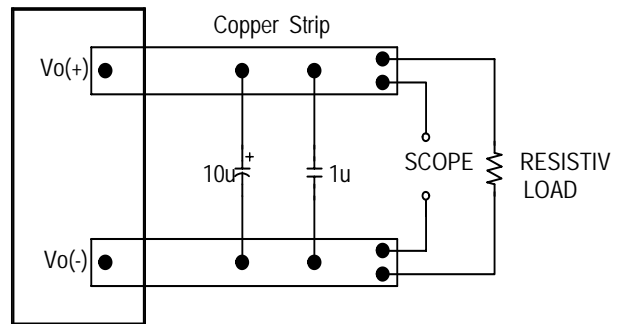

Figure 14: Output voltage noise and ripple measurement test setup

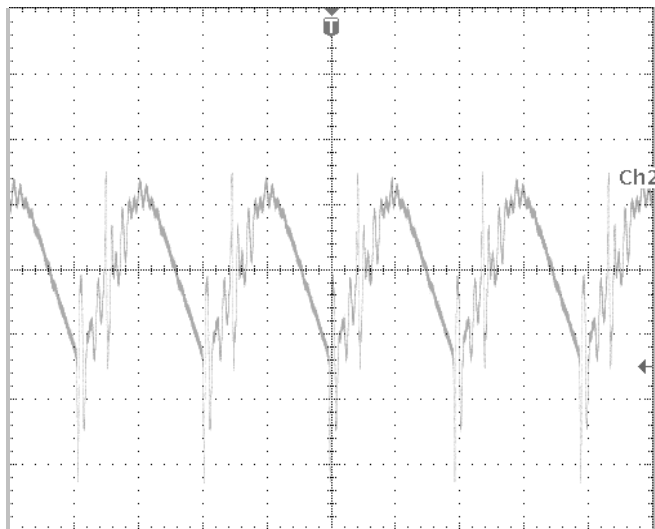

Figure 15: Output voltage ripple at nominal input voltage and rated load current ($I_o=5\text{A}$) (10mV/div , $2\mu\text{s/div}$)
Load capacitance: $1\mu\text{F}$ ceramic capacitor and $10\mu\text{F}$ tantalum capacitor. Bandwidth: 20 MHz . Scope measurements should be made using a BNC cable (length shorter than 20 inches). Position the load between 51 mm to 76 mm (2 inches to 3 inches) from the module.

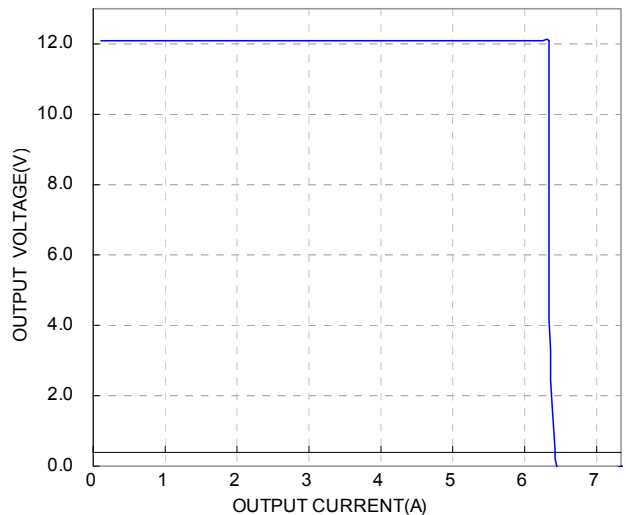

Figure 16: Output voltage vs. load current showing typical current limit curves and converter shutdown points

DESIGN CONSIDERATIONS

Input Source Impedance

The impedance of the input source connecting to the DC/DC power modules will interact with the modules and affect the stability. A low ac-impedance input source is recommended. If the source inductance is more than a few μH , we advise adding a 10 to 100 μF electrolytic capacitor (ESR $< 0.7 \Omega$ at 100 kHz) mounted close to the input of the module to improve the stability.

Layout and EMC Considerations

Delta's DC/DC power modules are designed to operate in a wide variety of systems and applications. For design assistance with EMC compliance and related PWB layout issues, please contact Delta's technical support team. An external input filter module is available for easier EMC compliance design..below is the reference design for an input filter tested with E36SR12005 to meet class B .

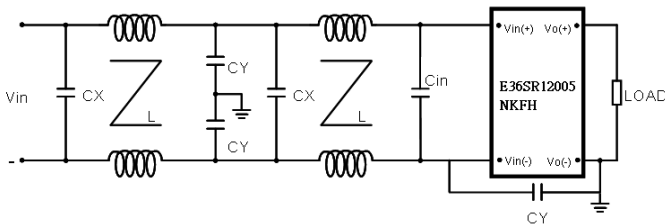

With filter, $C_{in}=100\mu\text{F}/100\text{V}$, $C_y=1.5\text{nF}$, $C_x=2.2\mu\text{F}$, $L=0.53\text{mH}$.

Test Result: $v_{in}=48\text{V}$, $i_o=5\text{A}$.

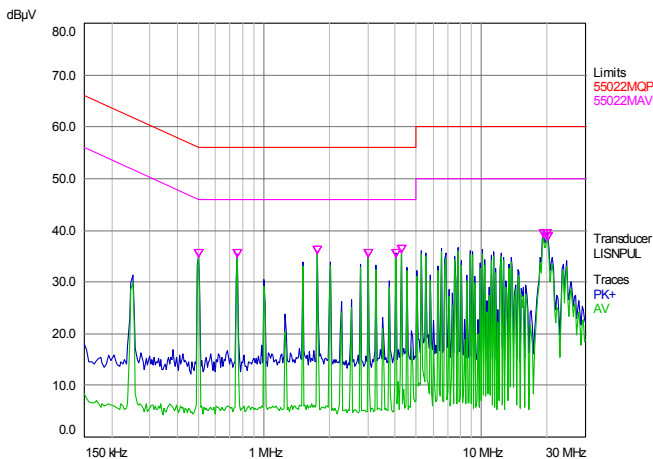

Blue line is peak mode, green is average mode.

Safety Considerations

The power module must be installed in compliance with the spacing and separation requirements of the end-user's safety agency standard, i.e., UL60950-1, CSA C22.2 NO. 60950-1 2nd and IEC 60950-1 2nd : 2005 and EN 60950-1 2nd: 2006+A11+A1: 2010, if the system in which the power module is to be used must meet safety agency requirements.

Basic insulation based on 75 Vdc input is provided between the input and output of the module for the purpose of applying insulation requirements when the input to this DC-to-DC converter is identified as TNV-2 or SELV. An additional evaluation is needed if the source is other than TNV-2 or SELV.

When the input source is SELV circuit, the power module meets SELV (safety extra-low voltage) requirements. If the input source is a hazardous voltage which is greater than 75 Vdc and less than or equal to 75 Vdc, for the module's output to meet SELV requirements, all of the following must be met:

The input source must be insulated from the ac mains by reinforced or double insulation.

- The input terminals of the module are not operator accessible.
- A SELV reliability test is conducted on the system where the module is used, in combination with the module, to ensure that under a single fault, hazardous voltage does not appear at the module's output.

When installed into a Class II equipment (without grounding), spacing consideration should be given to the end-use installation, as the spacing between the module and mounting surface have not been evaluated.

The power module has extra-low voltage (SELV) outputs when all inputs are SELV.

This power module is not internally fused. To achieve optimum safety and system protection, an input line fuse is highly recommended. The safety agencies require a normal-blow fuse with 10A maximum rating to be installed in the ungrounded lead. A lower rated fuse can be used based on the maximum inrush transient energy and maximum input current.

Soldering and Cleaning Considerations

Post solder cleaning is usually the final board assembly process before the board or system undergoes electrical testing. Inadequate cleaning and/or drying may lower the reliability of a power module and severely affect the finished circuit board assembly test. Adequate cleaning and/or drying are especially important for un-encapsulated and/or open frame type power modules. For assistance on appropriate soldering and cleaning procedures, please contact Delta's technical support team.

FEATURES DESCRIPTIONS

Over-Current Protection

The modules include an internal output over-current protection circuit, which will endure current limiting for an unlimited duration during output overload. If the output current exceeds the OCP set point, the modules will automatically shut down (hiccup mode).

The modules will try to restart after 200ms. If the overload condition still exists, the module will shut down again. This restart trial will continue until the overload condition is corrected.

Over-Voltage Protection

The modules include an internal output over-voltage protection circuit, which monitors the voltage on the output terminals. If this voltage exceeds the over-voltage set point, the module will shut down (Hiccup mode). The modules will try to restart after 200ms. If the fault condition still exists, the module will shut down again. This restart trial will continue until the fault condition is corrected.

Over-Temperature Protection

The over-temperature protection consists of circuitry that provides protection from thermal damage. If the temperature exceeds the over-temperature threshold the module will shut down.

The module will try to restart after the module go back to safe temperature. If the over-temperature condition still exists during restart, the module will shut down again. This restart trial will continue until the temperature is within specification.

Remote On/Off

The remote on/off feature on the module can be either negative or positive logic. Negative logic turns the module on during a logic low and off during logic high. Positive logic turns the modules on during logic high and off during logic low.

Remote on/off can be controlled by an external switch between the on/off terminal and the Vi(-) terminal. The switch can be an open collector or open drain.

For negative logic if the remote on/off feature is not used, please short the on/off pin to Vi(-). For positive logic if the remote on/off feature is not used, please leave the on/off pin floating.

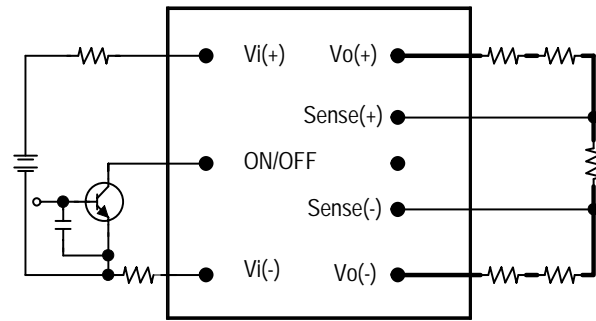

Figure 17: Remote on/off implementation

Remote Sense

Remote sense compensates for voltage drops on the output by sensing the actual output voltage at the point of load. The voltage between the remote sense pins and the output terminals must not exceed the output voltage sense range given here:

$$[Vo(+) - Vo(-)] - [SENSE(+) - SENSE(-)] \leq 10\% \times V_{out}$$

This limit includes any increase in voltage due to remote sense compensation

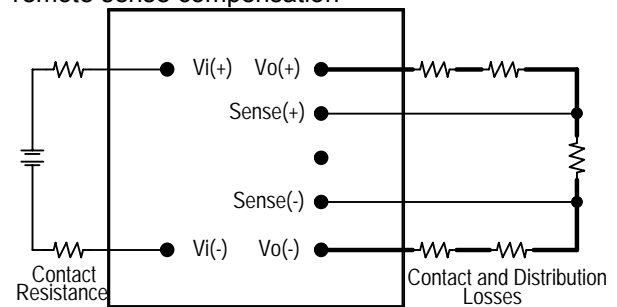

Figure 18: Effective circuit configuration for remote sense operation

If the remote sense feature is not used to regulate the output at the point of load, please connect SENSE(+) to Vo(+) and SENSE(-) to Vo(-) at the module.

The output voltage can be increased by the remote sense; When using the remote sense the output voltage of the module is usually increased, which increases the power output of the module with the same output current.

Care should be taken to ensure that the maximum output power does not exceed the maximum rated power.

THERMAL CONSIDERATIONS

Thermal management is an important part of the system design. To ensure proper, reliable operation, sufficient cooling of the power module is needed over the entire temperature range of the module. Convection cooling is usually the dominant mode of heat transfer.

Hence, the choice of equipment to characterize the thermal performance of the power module is a wind tunnel.

Thermal Testing Setup

Delta's DC/DC power modules are characterized in heated vertical wind tunnels that simulate the thermal environments encountered in most electronics equipment. This type of equipment commonly uses vertically mounted circuit cards in cabinet racks in which the power modules are mounted.

The following figure shows the wind tunnel characterization setup. The power module is mounted on a test PWB and is vertically positioned within the wind tunnel. The space between the neighboring PWB and the top of the power module is constantly kept at 6.35mm (0.25").

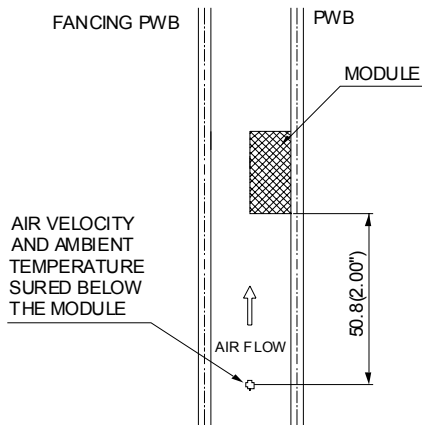

Note: Wind Tunnel Test Setup Figure Dimensions are in millimeters and (Inches)

Figure 19: Wind tunnel test setup

Thermal Derating

Heat can be removed by increasing airflow over the module. To enhance system reliability, the power module should always be operated below the maximum operating temperature. If the temperature exceeds the maximum module temperature, reliability of the unit may be affected.

THERMAL CURVES (WITHOUT HEAT SPREADER)

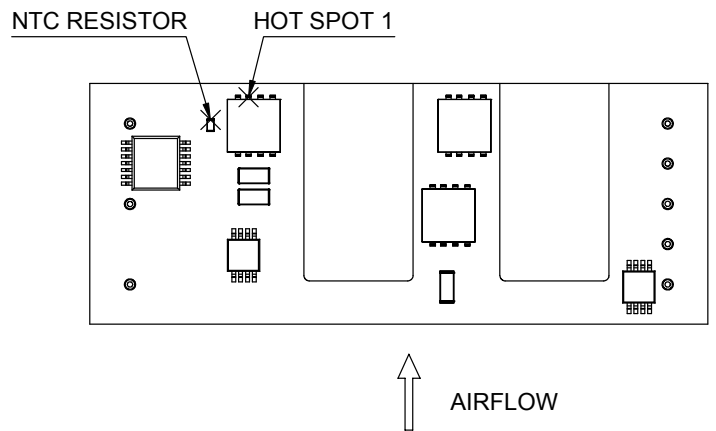

Figure 20: * Hot spot 1 & NTC resistor temperature measured points. The allowed maximum hot spot 1 temperature is defined at 121 .

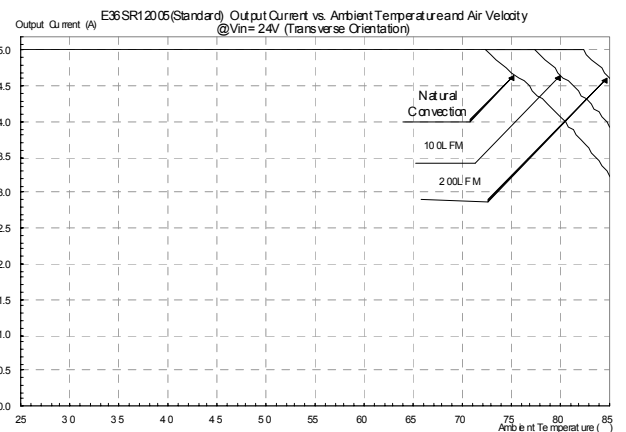

Figure 21: Output current vs. ambient temperature and air velocity @Vin=24V (Transverse orientation, airflow from Vin- to Vin+, without heat spreader)

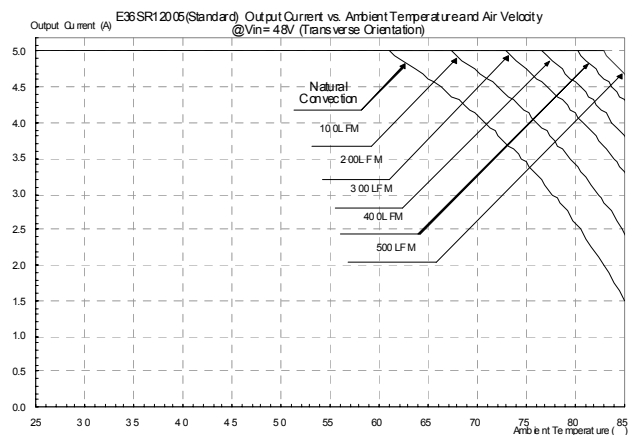

Figure 22: Output current vs. ambient temperature and air velocity @Vin=48V (Transverse orientation, airflow from Vin- to Vin+, without heat spreader)

THERMAL CURVES (WITHOUT HEAT SPREADER)

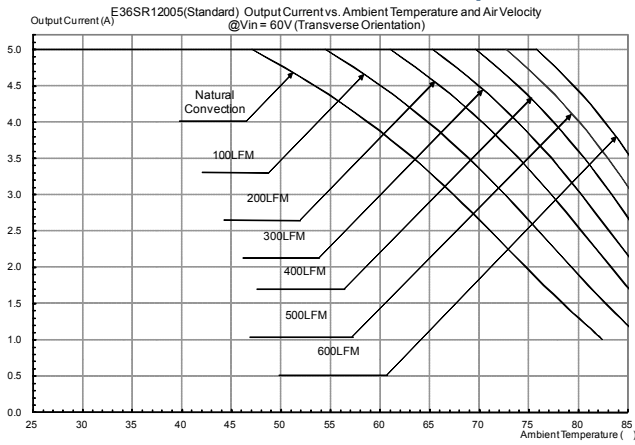

Figure 23: Output current vs. ambient temperature and air velocity @Vin=60V (Transverse orientation, airflow from Vin- to Vin+, without heat spreader)

THERMAL CURVES (WITH HEAT SPREADER)

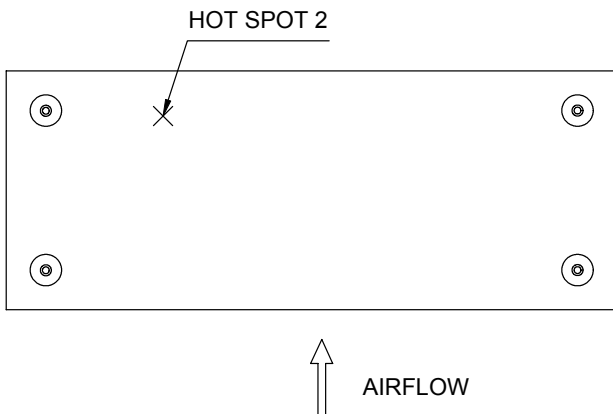

Figure 24: * Hot spot2 & NTC resistor temperature measured points. The allowed maximum hot spot 2 temperature is defined at 105 °C.

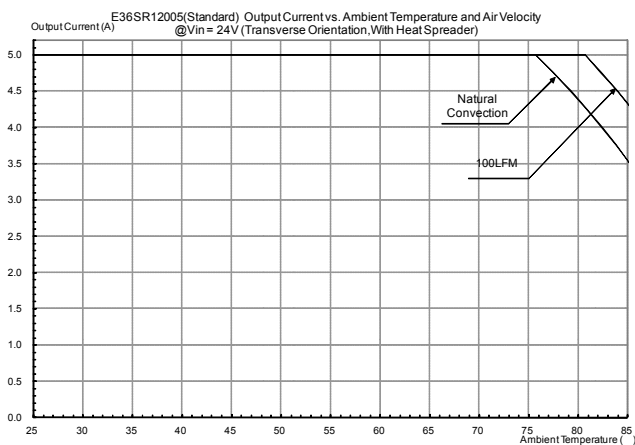

Figure 25: Output current vs. ambient temperature and air velocity @Vin=24V (Transverse orientation, airflow from Vin- to Vin+, with heat spreader)

THERMAL CURVES (WITH HEAT SPREADER)

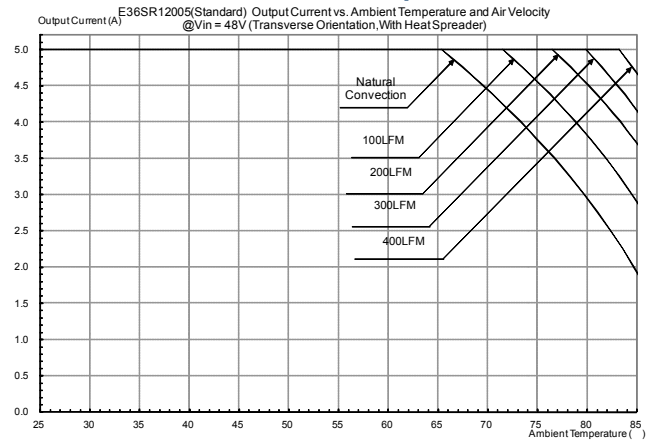

Figure 26: Output current vs. ambient temperature and air velocity @Vin=48V (Transverse orientation, airflow from Vin- to Vin+, with heat spreader)

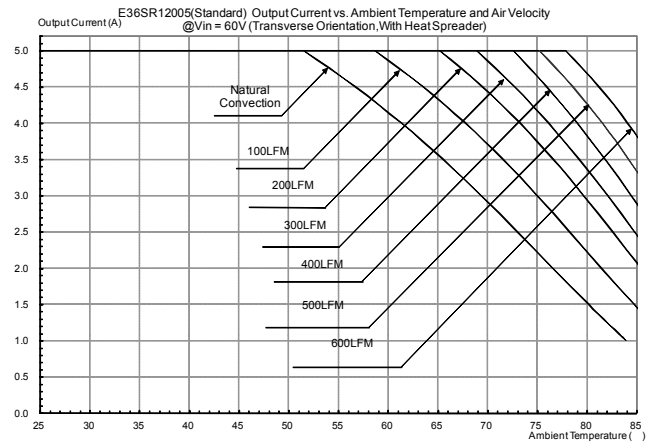
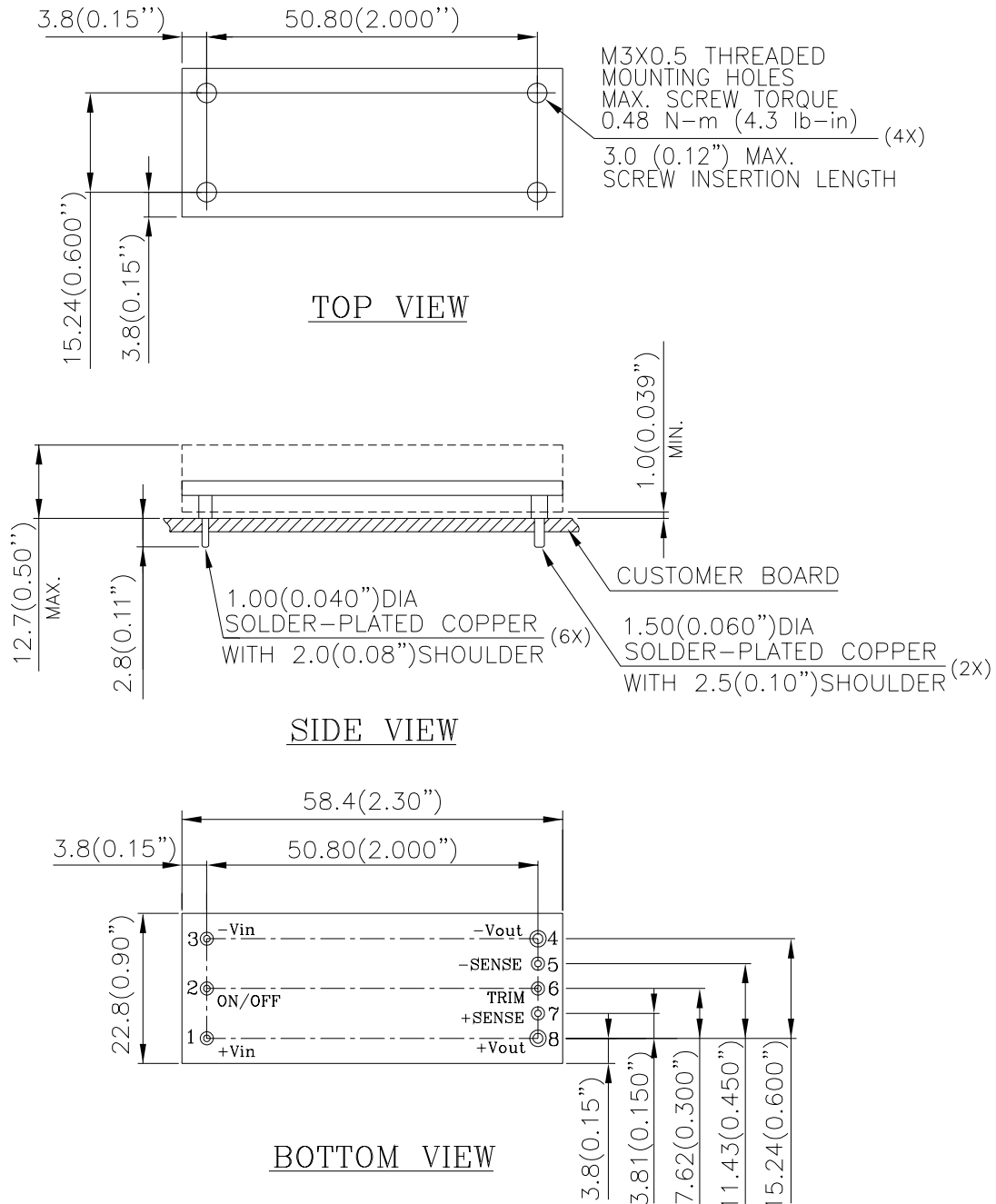

Figure 27: Output current vs. ambient temperature and air velocity @Vin=60V (Transverse orientation, airflow from Vin- to Vin+, with heat spreader)

MECHANICAL DRAWING(WITH HEAT-SPREADER)

* For modules with through-hole pins and the optional heatspreader, they are intended for wave soldering assembly onto system boards; please do not subject such modules through reflow temperature profile.



NOTES:

DIMENSIONS ARE IN MILLIMETERS AND (INCHES)

TOLERANCES: X.Xmm±0.5mm(X.XX in.±0.02 in.)

X.XXmm±0.25mm(X.XXX in.±0.010 in.)

PART NUMBERING SYSTEM

E	36	S	R	120	05	N	K	F	H
Form Factor	Input Voltage	Number of Outputs	Product Series	Output Voltage	Output Current	ON/OFF Logic	Pin Length		Option Code
E- Eighth Brick	24/48-18V~75V	S- Single	R – Regular product	12V	5A	N- Negative P- Positive	R - 0.170" N - 0.145" K - 0.11"	Space-RoHs 5/6 F- RoHS 6/6 (Lead Free)	A- Standard Functions H - with heat spreader

MODEL LIST

Model Name	Input Voltage	Output Voltage	Output Current	Lead Free	Efficiency@12V,5A
E36SR12005NKFA	18V~75V	12V	5A	RoHS 6	90.5%
E36SR12005NKFH	18V~75V	12V	5A	RoHS 6	90.5%

CONTACT: www.deltaww.com/dcdc

USA:

Telephone:
East Coast: 978-656-3993
West Coast: 510-668-5100
Fax: (978) 656 3964
Email: DCDC@delta-corp.com

Europe:

Phone: +31-20-655-0967
Fax: +31-20-655-0999
Email: DCDC@delta-es.com

Asia & the rest of world:

Telephone: +886 3 4526107
ext 6220~6224
Fax: +886 3 4513485
Email: DCDC@delta.com.tw

WARRANTY

Delta offers a two (2) year limited warranty. Complete warranty information is listed on our web site or is available upon request from Delta.

Information furnished by Delta is believed to be accurate and reliable. However, no responsibility is assumed by Delta for its use, nor for any infringements of patents or other rights of third parties, which may result from its use. No license is granted by implication or otherwise under any patent or patent rights of Delta. Delta reserves the right to revise these specifications at any time, without notice.