



Inductors for High Frequency Circuits

Multilayer Ceramic

MHQ-P series

MHQ0603P	0603 [0201 inch]*
MHQ1005P	1005 [0402 inch]

* Dimensions Code JIS[EIA]

REMINDERS FOR USING THESE PRODUCTS

Before using these products, be sure to request the delivery specifications.

SAFETY REMINDERS

Please pay sufficient attention to the warnings for safe designing when using these products.

REMINDERS

- The storage period is less than 12 months. Be sure to follow the storage conditions (Temperature: 5 to 40°C, Humidity: 10 to 75% RH or less).
If the storage period elapses, the soldering of the terminal electrodes may deteriorate.
- Do not use or store in locations where there are conditions such as gas corrosion (salt, acid, alkali, etc.).
- Before soldering, be sure to preheat components.
The preheating temperature should be set so that the temperature difference between the solder temperature and chip temperature does not exceed 150°C.
- Soldering corrections after mounting should be within the range of the conditions determined in the specifications.
If overheated, a short circuit, performance deterioration, or lifespan shortening may occur.
- When embedding a printed circuit board where a chip is mounted to a set, be sure that residual stress is not given to the chip due to the overall distortion of the printed circuit board and partial distortion such as at screw tightening portions.
- Self heating (temperature increase) occurs when the power is turned ON, so the tolerance should be sufficient for the set thermal design.
- Carefully lay out the coil for the circuit board design of the non-magnetic shield type.
A malfunction may occur due to magnetic interference.
- Use a wrist band to discharge static electricity in your body through the grounding wire.
- Do not expose the products to magnets or magnetic fields.
- Do not use for a purpose outside of the contents regulated in the delivery specifications.
- The products listed on this catalog are intended for use in general electronic equipment (AV equipment, telecommunications equipment, home appliances, amusement equipment, computer equipment, personal equipment, office equipment, measurement equipment, industrial robots) under a normal operation and use condition.
The products are not designed or warranted to meet the requirements of the applications listed below, whose performance and/or quality require a more stringent level of safety or reliability, or whose failure, malfunction or trouble could cause serious damage to society, person or property.
If you intend to use the products in the applications listed below or if you have special requirements exceeding the range or conditions set forth in the each catalog, please contact us.

- (1) Aerospace/Aviation equipment
- (2) Transportation equipment (cars, electric trains, ships, etc.)
- (3) Medical equipment
- (4) Power-generation control equipment
- (5) Atomic energy-related equipment
- (6) Seabed equipment
- (7) Transportation control equipment

- (8) Public information-processing equipment
- (9) Military equipment
- (10) Electric heating apparatus, burning equipment
- (11) Disaster prevention/crime prevention equipment
- (12) Safety equipment
- (13) Other applications that are not considered general-purpose applications

When designing your equipment even for general-purpose applications, you are kindly requested to take into consideration securing protection circuit/device or providing backup circuits in your equipment.

Inductors for High Frequency Circuits

Multilayer Ceramic

Product compatible with RoHS directive
Halogen-free
Compatible with lead-free solders
AEC-Q200

Overview of the MHQ-P Series

FEATURES

- Unique ceramic material and configuration allows for the realization of high Q characteristics that are equivalent to that of air core wound inductors.
- Multilayer method allows for a lineup with fine increments of inductance.

APPLICATION

Smart phones, tablet terminals, high frequency modules (PAs, VCOs, FEMs , etc.), Bluetooth, W-LAN, UWB, tuners, automotive equipment and other high frequency circuits for the mobile communication industry

PART NUMBER CONSTRUCTION

Series name	LxWxH Dimensions (mm)		Characteristics	Inductance (nH)		Inductance tolerance		Packaging style	Internal code
MHQ	0603		P	0N6	0.6	B	±0.1nH	T	Taping
	1005	1.0x0.5x0.5		1N1	1.1	C	±0.2nH		
				11N	11	S	±0.3nH		
						G	±2%		
						H	±3%		
						J	±5%		

OPERATING TEMPERATURE RANGE, PACKAGE QUANTITY, PRODUCT WEIGHT

Type	Temperature range		Package quantity	Individual weight
	Operating temperature	Storage temperature*		
	(°C)	(°C)	(pieces/reel)	(mg)
MHQ0603P	-55 to +125	-55 to +125	15000	1
MHQ1005P	-55 to +125	-55 to +125	10000	1

* The Storage temperature range is for after the circuit board is mounted.

- RoHS Directive Compliant Product: See the following for more details related to RoHS Directive compliant products. <http://www.tdk.co.jp/rohs/>
- Halogen-free: Indicates that Cl content is less than 900ppm, Br content is less than 900ppm, and that the total Cl and Br content is less than 1500ppm.

• All specifications are subject to change without notice.

Overview of the MHQ-P Series

RECOMMENDED REFLOW PROFILE

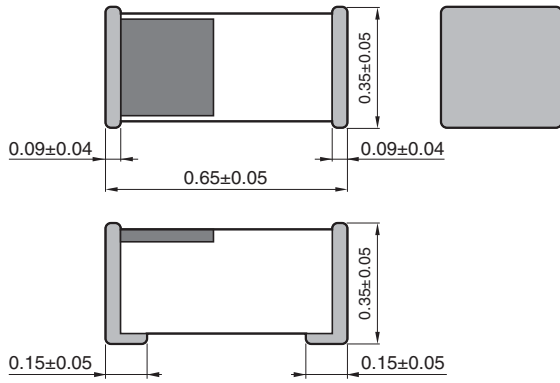

Preheating			Soldering		Peak	
Temp.	Temp.	Time	Temp.	Time	Temp.	Time
T1	T2	t1	T3	t2	T4	t3
150°C	180°C	60 to 120s	230°C	30 to 60s	250 to 260°C	10s max.

MHQ-P_{series}**MHQ0603P Type****SHAPE & DIMENSIONS**

Dimensions in mm

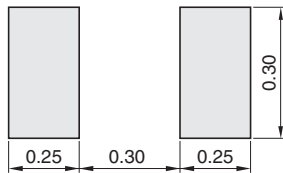
RECOMMENDED LAND PATTERN

Dimensions in mm

MHQ-P_{series} **MHQ0603P Type**

■ ELECTRICAL CHARACTERISTICS

□ CHARACTERISTICS SPECIFICATION TABLE

L (nH)	Tolerance	L measuring frequency (MHz)	Q min.	Q measuring frequency (MHz)	Self-resonant frequency (GHz)		DC resistance (Ω)		Rated current (mA) max.	Part No.*
					min.	typ.	max.	typ.		
0.6	±0.1, ±0.2nH	500	—	500	10.0	20.0	0.07	0.02	1000	MHQ0603P0N6△T□□□
0.7	±0.1, ±0.2nH	500	—	500	10.0	20.0	0.07	0.02	1000	MHQ0603P0N7△T□□□
0.8	±0.1, ±0.2nH	500	—	500	10.0	20.0	0.07	0.02	1000	MHQ0603P0N8△T□□□
0.9	±0.1, ±0.2nH	500	—	500	10.0	18.8	0.07	0.02	1000	MHQ0603P0N9△T□□□
1.0	±0.1, ±0.2, ±0.3nH	500	—	500	10.0	19.3	0.07	0.03	1000	MHQ0603P1N0△T□□□
1.1	±0.1, ±0.2, ±0.3nH	500	—	500	10.0	19.3	0.07	0.03	1000	MHQ0603P1N1△T□□□
1.2	±0.1, ±0.2, ±0.3nH	500	—	500	10.0	20.0	0.08	0.04	1000	MHQ0603P1N2△T□□□
1.3	±0.1, ±0.2, ±0.3nH	500	—	500	10.0	20.0	0.10	0.06	800	MHQ0603P1N3△T□□□
1.4	±0.1, ±0.2, ±0.3nH	500	—	500	10.0	18.6	0.10	0.06	800	MHQ0603P1N4△T□□□
1.5	±0.1, ±0.2, ±0.3nH	500	16	500	10.0	19.5	0.10	0.05	800	MHQ0603P1N5△T□□□
1.6	±0.1, ±0.2, ±0.3nH	500	16	500	10.0	17.5	0.10	0.06	800	MHQ0603P1N6△T□□□
1.7	±0.1, ±0.2, ±0.3nH	500	16	500	10.0	16.7	0.10	0.07	800	MHQ0603P1N7△T□□□
1.8	±0.1, ±0.2, ±0.3nH	500	16	500	10.0	15.8	0.12	0.07	700	MHQ0603P1N8△T□□□
1.9	±0.1, ±0.2, ±0.3nH	500	16	500	10.0	16.1	0.12	0.08	700	MHQ0603P1N9△T□□□
2.0	±0.1, ±0.2, ±0.3nH	500	16	500	10.0	13.8	0.12	0.08	700	MHQ0603P2N0△T□□□
2.1	±0.1, ±0.2, ±0.3nH	500	16	500	10.0	12.7	0.15	0.08	700	MHQ0603P2N1△T□□□
2.2	±0.1, ±0.2, ±0.3nH	500	16	500	10.0	13.2	0.15	0.09	700	MHQ0603P2N2△T□□□
2.3	±0.1, ±0.2, ±0.3nH	500	16	500	10.0	12.5	0.15	0.08	700	MHQ0603P2N3△T□□□
2.4	±0.1, ±0.2, ±0.3nH	500	16	500	8.0	11.7	0.15	0.08	700	MHQ0603P2N4△T□□□
2.5	±0.1, ±0.2, ±0.3nH	500	16	500	8.0	11.1	0.25	0.17	500	MHQ0603P2N5△T□□□
2.6	±0.1, ±0.2, ±0.3nH	500	16	500	8.0	11.1	0.25	0.16	500	MHQ0603P2N6△T□□□
2.7	±0.1, ±0.2, ±0.3nH	500	16	500	8.0	10.5	0.25	0.16	500	MHQ0603P2N7△T□□□
2.8	±0.1, ±0.2, ±0.3nH	500	16	500	8.0	10.6	0.25	0.18	500	MHQ0603P2N8△T□□□
2.9	±0.1, ±0.2, ±0.3nH	500	16	500	8.0	10.8	0.30	0.19	450	MHQ0603P2N9△T□□□
3.0	±0.1, ±0.2, ±0.3nH	500	16	500	8.0	10.3	0.30	0.19	450	MHQ0603P3N0△T□□□
3.1	±0.1, ±0.2, ±0.3nH	500	16	500	8.0	10.5	0.30	0.19	450	MHQ0603P3N1△T□□□
3.2	±0.1, ±0.2, ±0.3nH	500	16	500	7.0	9.5	0.20	0.13	550	MHQ0603P3N2△T□□□
3.3	±0.1, ±0.2, ±0.3nH	500	16	500	7.0	9.6	0.25	0.15	500	MHQ0603P3N3△T□□□
3.4	±0.1, ±0.2, ±0.3nH	500	16	500	6.5	9.3	0.25	0.14	500	MHQ0603P3N4△T□□□
3.5	±0.1, ±0.2, ±0.3nH	500	16	500	6.5	9.5	0.25	0.17	500	MHQ0603P3N5△T□□□
3.6	±0.1, ±0.2, ±0.3nH	500	16	500	6.5	9.1	0.25	0.16	500	MHQ0603P3N6△T□□□
3.7	±0.1, ±0.2, ±0.3nH	500	16	500	6.5	9.1	0.25	0.17	450	MHQ0603P3N7△T□□□
3.8	±0.1, ±0.2, ±0.3nH	500	16	500	6.5	9.1	0.30	0.19	450	MHQ0603P3N8△T□□□
3.9	±0.1, ±0.2, ±0.3nH	500	16	500	6.5	9.2	0.35	0.23	400	MHQ0603P3N9△T□□□
4.0	±0.1, ±0.2, ±0.3nH	500	16	500	6.0	8.5	0.35	0.26	400	MHQ0603P4N0△T□□□
4.1	±0.1, ±0.2, ±0.3nH	500	16	500	6.0	8.3	0.35	0.22	400	MHQ0603P4N1△T□□□
4.2	±0.1, ±0.2, ±0.3nH	500	16	500	6.0	8.2	0.35	0.23	400	MHQ0603P4N2△T□□□
4.3	±0.2, ±0.3nH, ±3%	500	16	500	6.0	8.2	0.35	0.23	400	MHQ0603P4N3△T□□□
4.7	±0.2, ±0.3nH, ±3%	500	16	500	5.5	7.9	0.40	0.25	350	MHQ0603P4N7△T□□□
5.1	±0.2, ±0.3nH, ±3%	500	16	500	5.5	7.8	0.40	0.24	350	MHQ0603P5N1△T□□□
5.6	±0.2, ±0.3nH, ±3%	500	16	500	5.0	7.1	0.40	0.29	350	MHQ0603P5N6△T□□□
6.2	±0.3nH, ±3%	500	16	500	4.0	6.7	0.70	0.52	300	MHQ0603P6N2△T□□□

* The "△" of the Part Number contains the inductance tolerance code, B (±0.1nH), C (±0.2nH), S (±0.3nH), G (±2%), H (±3%) or J (±5%).

* The "□□□" of the Part Number contains the internal code.

· Short bar residual inductance = 0.556nH

○ Measurement equipment

Measurement item	Product No.	Manufacturer
L, Q	4991A+16197A	Agilent Technologies
Self-resonant frequency	8720C	Agilent Technologies
DC resistance	Type-7561	Yokogawa

* Equivalent measurement equipment may be used.

• All specifications are subject to change without notice.

MHQ-P_{series} **MHQ0603P Type**

■ ELECTRICAL CHARACTERISTICS

□ CHARACTERISTICS SPECIFICATION TABLE

L (nH)	Tolerance	L measuring frequency (MHz)	Q min.	Q measuring frequency (MHz)	Self-resonant frequency (GHz)		DC resistance (Ω)		Rated current (mA) max.	Part No.*
					min.	typ.	max.	typ.		
6.8	±3%, ±5%	500	16	500	4.0	6.8	0.70	0.53	300	MHQ0603P6N8△T□□□
7.5	±3%, ±5%	500	16	500	3.8	5.7	0.50	0.37	300	MHQ0603P7N5△T□□□
8.2	±3%, ±5%	500	16	500	3.8	5.4	0.90	0.64	250	MHQ0603P8N2△T□□□
9.1	±3%, ±5%	500	16	500	3.8	5.5	0.90	0.62	250	MHQ0603P9N1△T□□□
10	±3%, ±5%	500	16	500	3.5	5.2	1.20	0.86	240	MHQ0603P10N△T□□□
11	±3%, ±5%	500	16	500	3.2	4.6	1.30	0.89	240	MHQ0603P11N△T□□□
12	±3%, ±5%	500	16	500	3.2	4.6	1.40	0.77	240	MHQ0603P12N△T□□□
13	±3%, ±5%	500	16	500	3.2	4.5	1.50	1.01	180	MHQ0603P13N△T□□□
15	±3%, ±5%	500	16	500	2.8	4.2	1.50	1.05	180	MHQ0603P15N△T□□□
16	±3%, ±5%	500	16	500	2.5	4.0	1.70	1.21	180	MHQ0603P16N△T□□□
18	±3%, ±5%	500	16	500	2.4	3.7	1.70	1.21	180	MHQ0603P18N△T□□□
20	±3%, ±5%	500	16	500	2.4	3.5	2.00	1.38	160	MHQ0603P20N△T□□□
22	±3%, ±5%	500	16	500	2.2	3.3	2.00	1.40	160	MHQ0603P22N△T□□□
24	±3%, ±5%	500	16	500	2.1	3.1	2.20	1.55	160	MHQ0603P24N△T□□□
27	±3%, ±5%	500	16	500	2.0	2.9	2.20	1.55	160	MHQ0603P27N△T□□□
30	±3%, ±5%	500	16	500	1.9	2.7	2.70	1.98	160	MHQ0603P30N△T□□□
33	±3%, ±5%	300	14	300	1.8	2.5	2.80	2.06	160	MHQ0603P33N△T□□□
36	±3%, ±5%	300	14	300	1.7	2.4	2.80	2.08	160	MHQ0603P36N△T□□□
39	±3%, ±5%	300	14	300	1.6	2.3	3.00	2.24	160	MHQ0603P39N△T□□□

* The "△" of the Part Number contains the inductance tolerance code, B (±0.1nH) , C (±0.2nH) , S (±0.3nH) , G (±2%) , H (±3%) or J (±5%) .

* The "□□□" of the Part Number contains the internal code.

· Short bar residual inductance =0.556nH

○ Measurement equipment

Measurement item	Product No.	Manufacturer
L, Q	4991A+16197A	Agilent Technologies
Self-resonant frequency	8720C	Agilent Technologies
DC resistance	Type-7561	Yokogawa

* Equivalent measurement equipment may be used.

MHQ-P_{series} **MHQ0603P Type**

■ ELECTRICAL CHARACTERISTICS

□ L, Q FREQUENCY CHARACTERISTICS TABLE

L(nH)typ.					Q typ.					Part No.*
500MHz	800MHz	1.8GHz	2.0GHz	2.4GHz	500MHz	800MHz	1.8GHz	2.0GHz	2.4GHz	
0.6	0.6	0.6	0.6	0.6	29min.	38min.	58min.	60min.	66min.	MHQ0603P0N6△T□□□
0.7	0.7	0.7	0.7	0.7	29min.	38min.	58min.	60min.	66min.	MHQ0603P0N7△T□□□
0.8	0.8	0.8	0.8	0.8	29min.	38min.	58min.	60min.	66min.	MHQ0603P0N8△T□□□
0.9	0.9	0.9	0.9	0.9	29min.	38min.	58min.	60min.	66min.	MHQ0603P0N9△T□□□
1.0	1.0	1.0	1.0	1.0	29min.	38min.	58min.	60min.	66min.	MHQ0603P1N0△T□□□
1.1	1.1	1.1	1.1	1.1	29min.	38min.	58min.	60min.	66min.	MHQ0603P1N1△T□□□
1.2	1.2	1.2	1.2	1.2	29min.	38min.	58min.	60min.	66min.	MHQ0603P1N2△T□□□
1.3	1.3	1.3	1.3	1.3	29min.	38min.	58min.	60min.	66min.	MHQ0603P1N3△T□□□
1.4	1.4	1.4	1.4	1.4	29min.	38min.	58min.	60min.	66min.	MHQ0603P1N4△T□□□
1.5	1.5	1.5	1.5	1.5	29	38	58	60	66	MHQ0603P1N5△T□□□
1.6	1.6	1.6	1.6	1.6	28	37	56	60	66	MHQ0603P1N6△T□□□
1.7	1.7	1.7	1.7	1.7	30	39	62	65	71	MHQ0603P1N7△T□□□
1.8	1.8	1.8	1.8	1.8	29	38	59	62	69	MHQ0603P1N8△T□□□
1.9	1.9	1.9	1.9	1.9	28	38	57	60	66	MHQ0603P1N9△T□□□
2.0	2.0	2.0	2.0	2.0	27	35	55	58	64	MHQ0603P2N0△T□□□
2.1	2.1	2.1	2.1	2.2	29	37	58	62	68	MHQ0603P2N1△T□□□
2.2	2.2	2.2	2.2	2.3	28	37	57	61	68	MHQ0603P2N2△T□□□
2.3	2.3	2.3	2.3	2.4	31	40	61	64	71	MHQ0603P2N3△T□□□
2.4	2.4	2.4	2.4	2.5	31	41	62	64	71	MHQ0603P2N4△T□□□
2.5	2.5	2.5	2.6	2.6	25	32	51	53	59	MHQ0603P2N5△T□□□
2.6	2.6	2.6	2.7	2.7	26	34	54	56	62	MHQ0603P2N6△T□□□
2.7	2.7	2.7	2.8	2.8	26	34	54	57	63	MHQ0603P2N7△T□□□
2.8	2.8	2.8	2.9	2.9	26	35	54	55	62	MHQ0603P2N8△T□□□
2.9	2.9	2.9	3.0	3.0	24	31	48	51	56	MHQ0603P2N9△T□□□
3.0	3.0	3.0	3.1	3.1	23	30	46	48	52	MHQ0603P3N0△T□□□
3.1	3.1	3.2	3.2	3.2	24	32	49	51	57	MHQ0603P3N1△T□□□
3.2	3.2	3.3	3.3	3.4	27	35	53	55	61	MHQ0603P3N2△T□□□
3.3	3.3	3.4	3.4	3.5	25	32	48	50	54	MHQ0603P3N3△T□□□
3.4	3.4	3.5	3.5	3.6	27	35	53	55	61	MHQ0603P3N4△T□□□
3.5	3.5	3.6	3.6	3.7	25	33	50	52	57	MHQ0603P3N5△T□□□
3.6	3.6	3.7	3.7	3.8	26	33	50	52	57	MHQ0603P3N6△T□□□
3.7	3.7	3.8	3.8	3.9	26	34	51	52	58	MHQ0603P3N7△T□□□
3.8	3.8	3.9	3.9	4.0	24	32	49	51	56	MHQ0603P3N8△T□□□
3.9	3.9	4.0	4.1	4.2	23	30	47	49	54	MHQ0603P3N9△T□□□
4.0	4.0	4.1	4.2	4.3	26	34	52	53	59	MHQ0603P4N0△T□□□
4.1	4.1	4.2	4.3	4.4	23	30	46	48	52	MHQ0603P4N1△T□□□
4.2	4.2	4.3	4.4	4.5	24	31	46	48	52	MHQ0603P4N2△T□□□
4.3	4.3	4.4	4.5	4.6	25	33	49	51	56	MHQ0603P4N3△T□□□
4.7	4.7	4.9	4.9	5.1	24	31	47	49	54	MHQ0603P4N7△T□□□
5.1	5.1	5.3	5.4	5.5	25	32	49	51	56	MHQ0603P5N1△T□□□
5.6	5.6	5.9	6.0	6.2	24	31	46	48	52	MHQ0603P5N6△T□□□
6.2	6.2	6.6	6.7	7.0	21	28	42	43	47	MHQ0603P6N2△T□□□

* The "△" of the Part Number contains the inductance tolerance code, B ($\pm 0.1\text{nH}$), C ($\pm 0.2\text{nH}$), S ($\pm 0.3\text{nH}$), G ($\pm 2\%$), H ($\pm 3\%$) or J ($\pm 5\%$).

* The "□□□" of the Part Number contains the internal code.

○ Measurement equipment

Product No.	Manufacturer
4291B+16193A	Agilent Technologies

* Equivalent measurement equipment may be used.

MHQ-P_{series} **MHQ0603P Type**

■ ELECTRICAL CHARACTERISTICS

□ L, Q FREQUENCY CHARACTERISTICS TABLE

L(nH)typ.					Q typ.					Part No.*
500MHz	800MHz	1.8GHz	2.0GHz	2.4GHz	500MHz	800MHz	1.8GHz	2.0GHz	2.4GHz	
6.8	6.8	7.2	7.4	7.7	22	28	43	44	48	MHQ0603P6N8△T□□□
7.5	7.5	8.1	8.3	8.8	24	30	44	45	48	MHQ0603P7N5△T□□□
8.2	8.2	8.9	9.2	9.7	21	27	39	40	42	MHQ0603P8N2△T□□□
9.1	9.2	9.9	10.2	10.9	23	29	42	44	46	MHQ0603P9N1△T□□□
10	10	11	11	12	22	28	41	42	43	MHQ0603P10N△T□□□
11	11	12	13	14	21	27	37	38	39	MHQ0603P11N△T□□□
12	12	14	14	16	23	29	41	41	41	MHQ0603P12N△T□□□
13	13	15	16	18	21	27	36	36	36	MHQ0603P13N△T□□□
15	15	18	19	21	23	29	37	37	36	MHQ0603P15N△T□□□
16	16	19	20	23	22	28	37	37	35	MHQ0603P16N△T□□□
18	18	22	24	28	23	28	36	35	33	MHQ0603P18N△T□□□
20	21	26	28	34	22	27	33	32	27	MHQ0603P20N△T□□□
22	23	29	32	40	23	29	34	33	28	MHQ0603P22N△T□□□
24	25	34	38		22	26	29	27		MHQ0603P24N△T□□□
27	28	38	44		23	28	30	28		MHQ0603P27N△T□□□
30	32	47			22	27				MHQ0603P30N△T□□□
33	35	55			22	27				MHQ0603P33N△T□□□
36	38	67			22	26				MHQ0603P36N△T□□□
39	42	79			23	26				MHQ0603P39N△T□□□

* The "△" of the Part Number contains the inductance tolerance code, B ($\pm 0.1\text{nH}$), C ($\pm 0.2\text{nH}$), S ($\pm 0.3\text{nH}$), G ($\pm 2\%$), H ($\pm 3\%$) or J ($\pm 5\%$).

* The "□□□" of the Part Number contains the internal code.

○ Measurement equipment

Product No.	Manufacturer
4291B+16193A	Agilent Technologies

* Equivalent measurement equipment may be used.

MHQ-P_{series} MHQ0603PType

ELECTRICAL CHARACTERISTICS

L FREQUENCY CHARACTERISTICS GRAPH (EXAMPLE)

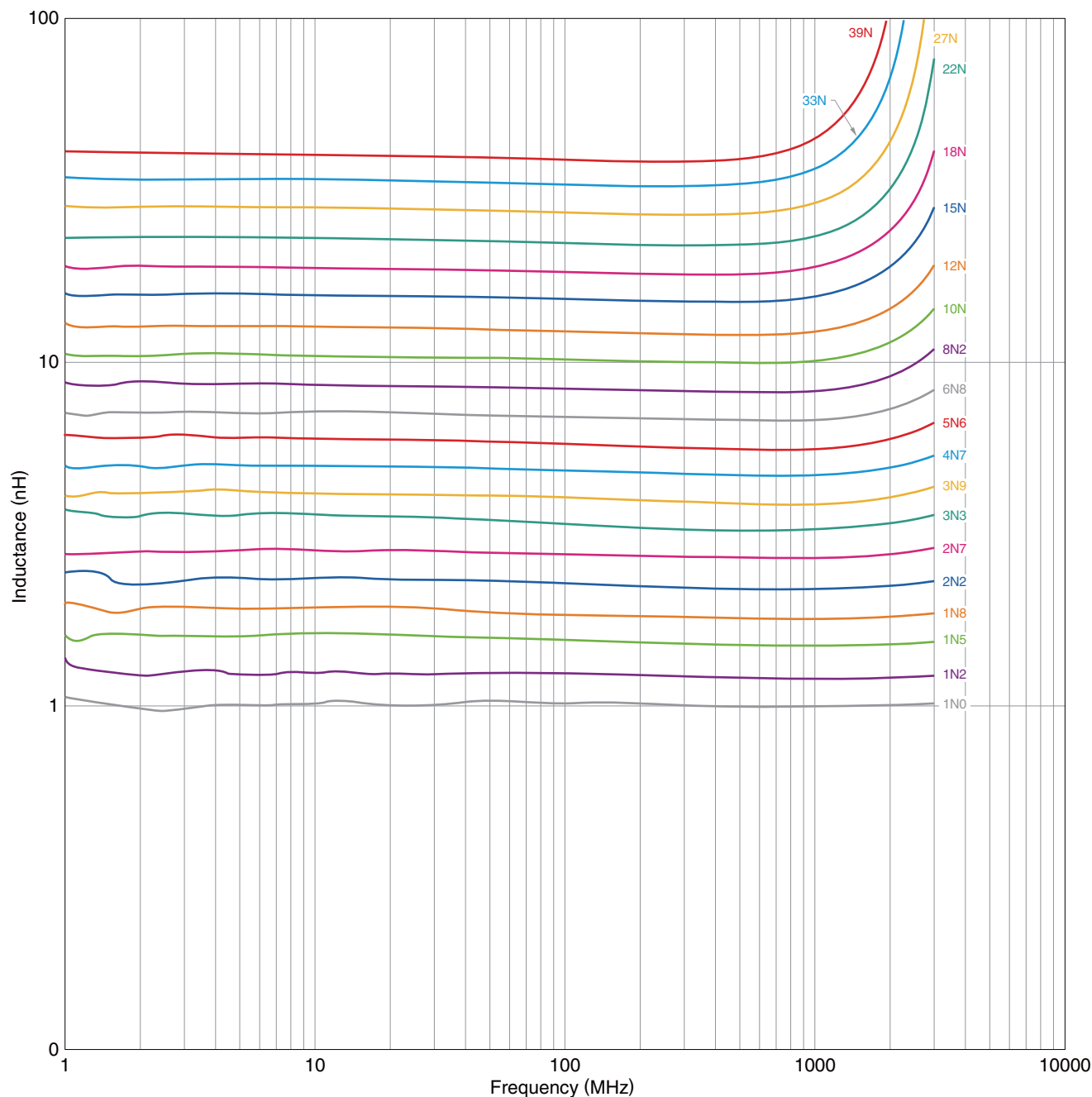

○ Measurement equipment

Product No.	Manufacturer
E4991+16193A	Agilent Technologies

* Equivalent measurement equipment may be used.

• All specifications are subject to change without notice.

MHQ-P_{series} MHQ0603P Type

ELECTRICAL CHARACTERISTICS

Q FREQUENCY CHARACTERISTICS GRAPH (EXAMPLE)

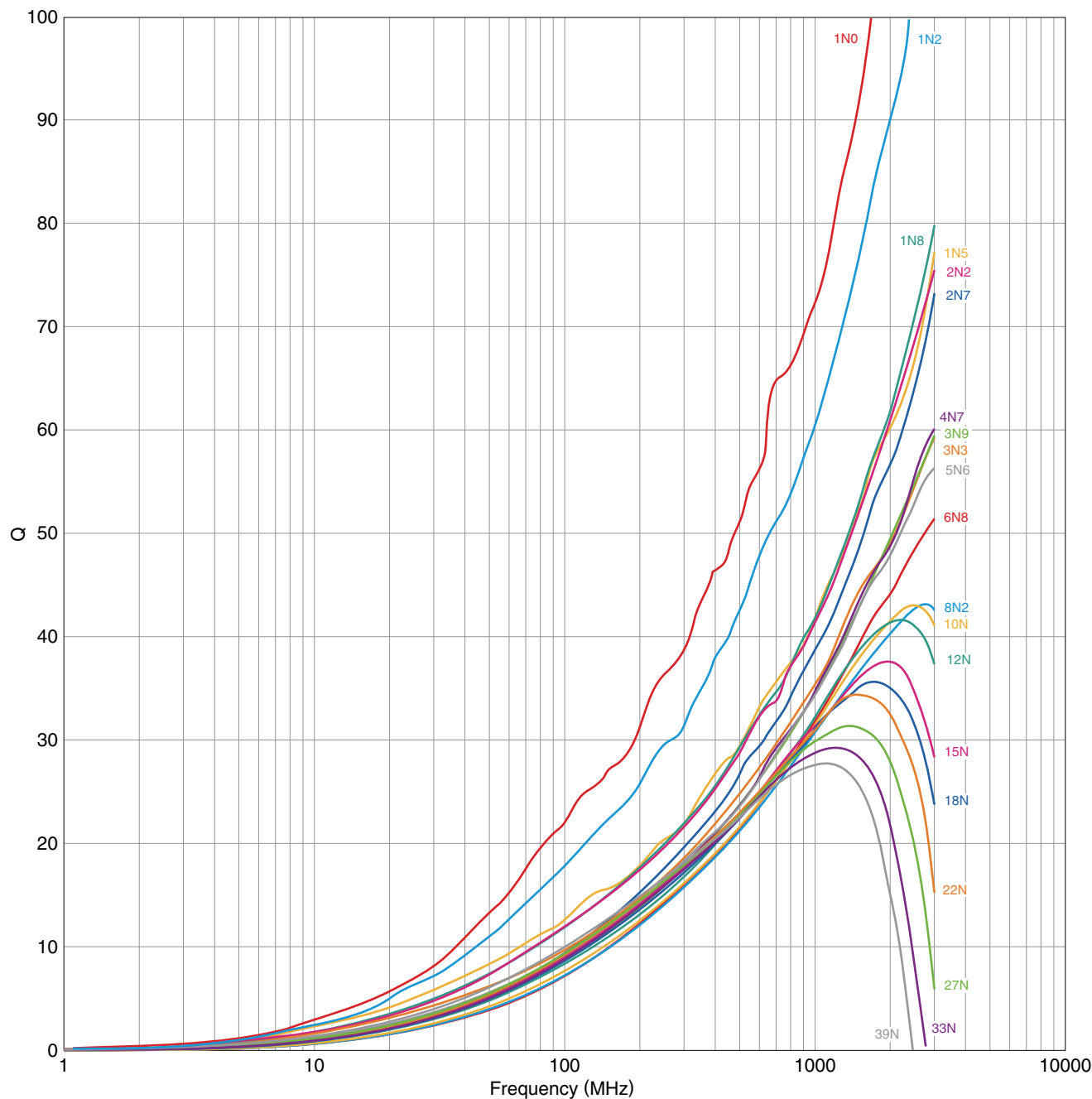

○ Measurement equipment

Product No.	Manufacturer
E4991+16193A	Agilent Technologies

* Equivalent measurement equipment may be used.

• All specifications are subject to change without notice.

MHQ-P_{series}

MHQ1005P Type



SHAPE & DIMENSIONS

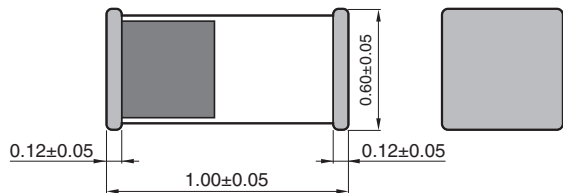

Dimensions in mm

RECOMMENDED LAND PATTERN

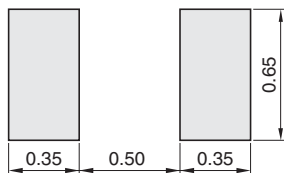

Dimensions in mm

• All specifications are subject to change without notice.

MHQ-P_{series} MHQ1005P Type

ELECTRICAL CHARACTERISTICS

CHARACTERISTICS SPECIFICATION TABLE

L (nH)	Tolerance	L measuring frequency (MHz)	Q min.	Q measuring frequency (MHz)	Self-resonant frequency (GHz)		DC resistance (Ω)		Rated current (mA) max.	Part No.*
					min.	typ.	max.	typ.		
1.0	$\pm 0.1, \pm 0.2, 0.3nH$	100	—	250	15.0	20.0	0.03	0.01	1200	MHQ1005P1N0 Δ T□□□
1.1	$\pm 0.1, \pm 0.2, 0.3nH$	100	—	250	14.0	20.0	0.03	0.02	1200	MHQ1005P1N1 Δ T□□□
1.2	$\pm 0.1, \pm 0.2, 0.3nH$	100	—	250	13.0	18.3	0.03	0.01	1200	MHQ1005P1N2 Δ T□□□
1.3	$\pm 0.1, \pm 0.2, 0.3nH$	100	—	250	12.0	20.0	0.03	0.01	1200	MHQ1005P1N3 Δ T□□□
1.5	$\pm 0.1, \pm 0.2, 0.3nH$	100	23	250	11.0	19.7	0.04	0.02	1000	MHQ1005P1N5 Δ T□□□
1.6	$\pm 0.1, \pm 0.2, 0.3nH$	100	23	250	10.0	15.2	0.04	0.02	1000	MHQ1005P1N6 Δ T□□□
1.8	$\pm 0.1, \pm 0.2, 0.3nH$	100	23	250	9.0	15.1	0.04	0.03	1000	MHQ1005P1N8 Δ T□□□
2.0	$\pm 0.1, \pm 0.2, 0.3nH$	100	23	250	8.0	11.5	0.05	0.03	1000	MHQ1005P2N0 Δ T□□□
2.2	$\pm 0.1, \pm 0.2, 0.3nH$	100	23	250	8.0	12.1	0.06	0.04	1000	MHQ1005P2N2 Δ T□□□
2.4	$\pm 0.1, \pm 0.2, 0.3nH$	100	23	250	6.5	9.8	0.06	0.04	1000	MHQ1005P2N4 Δ T□□□
2.7	$\pm 0.1, \pm 0.2, 0.3nH$	100	23	250	6.5	9.6	0.07	0.04	900	MHQ1005P2N7 Δ T□□□
3.0	$\pm 0.1, \pm 0.2, 0.3nH$	100	23	250	6.0	9.4	0.08	0.06	900	MHQ1005P3N0 Δ T□□□
3.3	$\pm 0.1, \pm 0.2, 0.3nH$	100	23	250	6.0	9.0	0.08	0.06	900	MHQ1005P3N3 Δ T□□□
3.6	$\pm 0.1, \pm 0.2, 0.3nH$	100	23	250	5.5	8.4	0.09	0.07	900	MHQ1005P3N6 Δ T□□□
3.9	$\pm 0.1, \pm 0.2, 0.3nH$	100	23	250	5.0	7.7	0.09	0.07	900	MHQ1005P3N9 Δ T□□□
4.3	$\pm 0.1, \pm 0.2, 0.3nH$	100	23	250	5.0	7.1	0.10	0.08	800	MHQ1005P4N3 Δ T□□□
4.7	$\pm 0.1, \pm 0.2, 0.3nH$	100	23	250	5.0	7.7	0.11	0.08	800	MHQ1005P4N7 Δ T□□□
5.1	$\pm 0.1, \pm 0.2, 0.3nH$	100	23	250	4.5	7.2	0.12	0.09	800	MHQ1005P5N1 Δ T□□□
5.6	$\pm 0.1, \pm 0.2, 0.3nH$	100	23	250	4.5	6.5	0.13	0.10	800	MHQ1005P5N6 Δ T□□□
6.2	$\pm 0.1, \pm 0.2, 0.3nH$	100	23	250	4.0	5.9	0.13	0.09	700	MHQ1005P6N2 Δ T□□□
6.8	$\pm 2\%, \pm 3\%, \pm 5\%$	100	23	250	4.0	5.8	0.14	0.10	700	MHQ1005P6N8 Δ T□□□
7.5	$\pm 2\%, \pm 3\%, \pm 5\%$	100	23	250	4.0	5.6	0.16	0.12	600	MHQ1005P7N5 Δ T□□□
8.2	$\pm 2\%, \pm 3\%, \pm 5\%$	100	23	250	3.6	4.9	0.16	0.12	550	MHQ1005P8N2 Δ T□□□
9.1	$\pm 2\%, \pm 3\%, \pm 5\%$	100	23	250	3.4	4.5	0.17	0.13	550	MHQ1005P9N1 Δ T□□□
10	$\pm 2\%, \pm 3\%, \pm 5\%$	100	23	250	3.3	4.6	0.19	0.15	500	MHQ1005P10N Δ T□□□
12	$\pm 2\%, \pm 3\%, \pm 5\%$	100	23	250	2.8	3.8	0.24	0.19	450	MHQ1005P12N Δ T□□□
15	$\pm 2\%, \pm 3\%, \pm 5\%$	100	23	250	2.3	3.2	0.28	0.22	400	MHQ1005P15N Δ T□□□

* The " Δ " of the Part Number contains the inductance tolerance code, B ($\pm 0.1nH$), C ($\pm 0.2nH$), S ($\pm 0.3nH$), G ($\pm 2\%$), H ($\pm 3\%$) or J ($\pm 5\%$).

* The "□□□" of the Part Number contains the internal code.

· Short bar residual inductance = 0.556nH

Measurement equipment

Measurement item	Product No.	Manufacturer
L, Q	4291B+16193A	Agilent Technologies
Self-resonant frequency	8720C	Agilent Technologies
DC resistance	Type-7561	Yokogawa

* Equivalent measurement equipment may be used.

MHQ-P_{series} **MHQ1005P Type**

■ ELECTRICAL CHARACTERISTICS

□ L, Q FREQUENCY CHARACTERISTICS TABLE

L(nH)typ.					Q typ.					Part No.*
500MHz	800MHz	1.8GHz	2.0GHz	2.4GHz	500MHz	800MHz	1.8GHz	2.0GHz	2.4GHz	
1.0	1.0	1.0	1.0	1.0	56min.	76min.	126min.	130min.	160min.	MHQ1005P1N0△T□□□
1.1	1.1	1.1	1.1	1.1	56min.	76min.	126min.	130min.	160min.	MHQ1005P1N1△T□□□
1.2	1.2	1.2	1.2	1.2	56min.	76min.	126min.	130min.	160min.	MHQ1005P1N2△T□□□
1.3	1.3	1.3	1.3	1.3	56min.	76min.	126min.	130min.	160min.	MHQ1005P1N3△T□□□
1.5	1.5	1.5	1.5	1.5	56	76	126	130	160	MHQ1005P1N5△T□□□
1.6	1.6	1.6	1.6	1.6	60	78	136	144	174	MHQ1005P1N6△T□□□
1.8	1.8	1.8	1.8	1.8	52	72	123	129	152	MHQ1005P1N8△T□□□
2.0	2.0	2.0	2.0	2.0	54	70	108	113	132	MHQ1005P2N0△T□□□
2.2	2.1	2.2	2.2	2.2	47	62	104	110	129	MHQ1005P2N2△T□□□
2.3	2.3	2.4	2.4	2.4	45	59	98	102	120	MHQ1005P2N4△T□□□
2.6	2.6	2.7	2.7	2.7	45	57	87	91	108	MHQ1005P2N7△T□□□
2.9	2.9	3.0	3.0	3.1	47	59	92	97	116	MHQ1005P3N0△T□□□
3.2	3.2	3.3	3.3	3.4	41	55	91	95	112	MHQ1005P3N3△T□□□
3.5	3.5	3.6	3.6	3.7	41	53	87	91	107	MHQ1005P3N6△T□□□
3.8	3.8	3.9	4.0	4.1	40	53	87	91	105	MHQ1005P3N9△T□□□
4.2	4.2	4.4	4.5	4.6	41	54	86	89	102	MHQ1005P4N3△T□□□
4.6	4.6	4.7	4.8	4.9	38	50	82	85	98	MHQ1005P4N7△T□□□
5.0	5.0	5.2	5.3	5.4	41	52	79	83	97	MHQ1005P5N1△T□□□
5.5	5.5	5.7	5.8	6.1	39	51	81	84	95	MHQ1005P5N6△T□□□
6.1	6.1	6.5	6.7	7.0	45	56	84	87	99	MHQ1005P6N2△T□□□
6.7	6.7	7.2	7.4	7.8	42	53	77	80	91	MHQ1005P6N8△T□□□
7.3	7.3	7.9	8.1	8.5	38	49	76	79	87	MHQ1005P7N5△T□□□
8.0	8.1	8.9	9.2	9.8	42	53	77	80	88	MHQ1005P8N2△T□□□
8.9	9.0	9.9	10.3	11.2	38	49	73	75	79	MHQ1005P9N1△T□□□
9.8	9.9	11.1	11.6	12.6	39	51	74	75	77	MHQ1005P10N△T□□□
12	12	14	14	16	39	49	67	68	70	MHQ1005P12N△T□□□
15	15	18	20	23	37	45	57	57	54	MHQ1005P15N△T□□□

* The "△" of the Part Number contains the inductance tolerance code, B ($\pm 0.1\text{nH}$), C ($\pm 0.2\text{nH}$), S ($\pm 0.3\text{nH}$), G ($\pm 2\%$), H ($\pm 3\%$) or J ($\pm 5\%$).

* The "□□□" of the Part Number contains the internal code.

○ Measurement equipment

Product No.	Manufacturer
4291B+16193A	Agilent Technologies

* Equivalent measurement equipment may be used.

MHQ-P_{series} MHQ1005PType

ELECTRICAL CHARACTERISTICS

L FREQUENCY CHARACTERISTICS GRAPH (EXAMPLE)

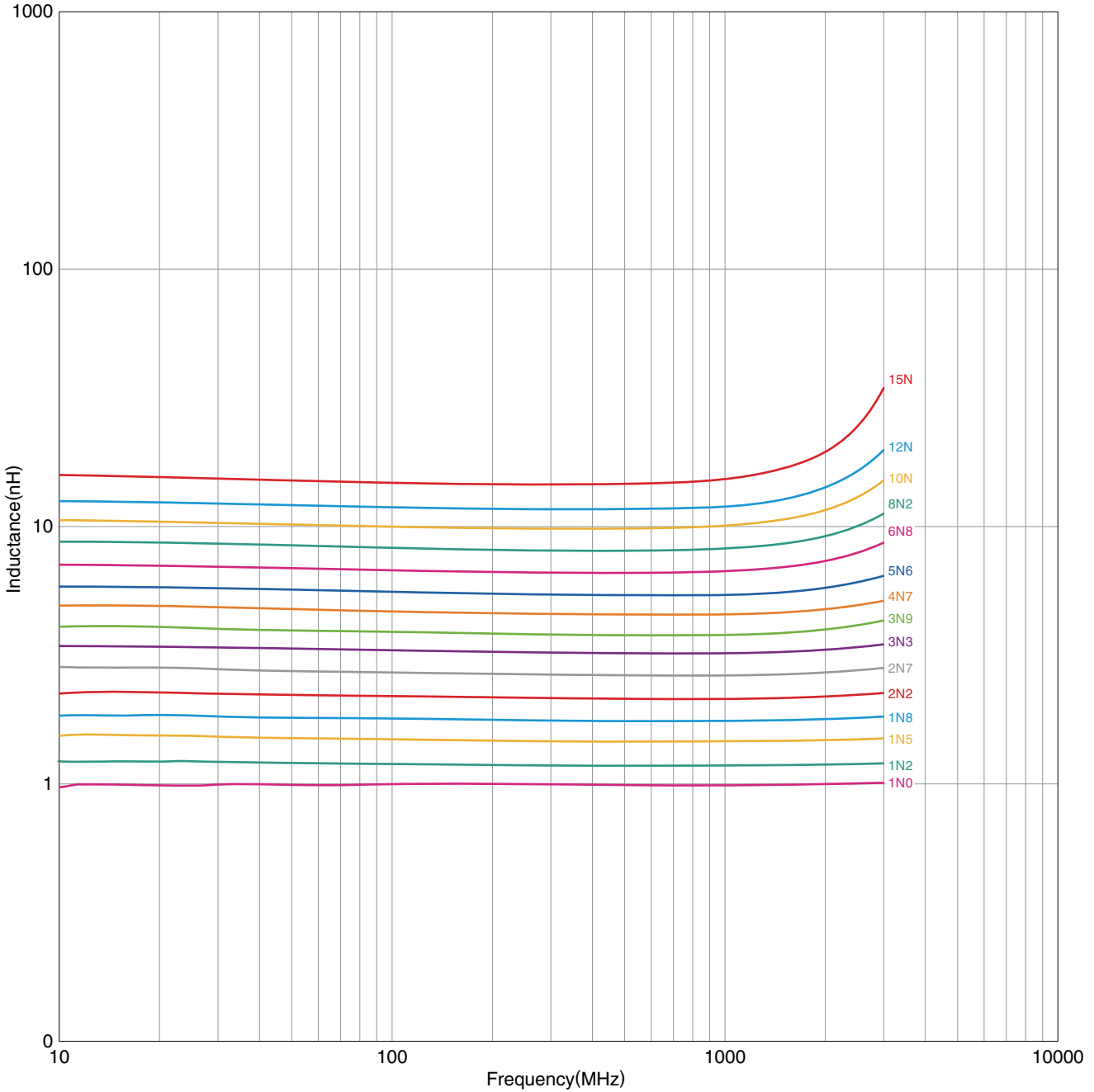

○ Measurement equipment

Product No.	Manufacturer
E4991+16193A	Agilent Technologies

* Equivalent measurement equipment may be used.

• All specifications are subject to change without notice.

MHQ-P_{series} MHQ1005P Type

ELECTRICAL CHARACTERISTICS

Q FREQUENCY CHARACTERISTICS GRAPH (EXAMPLE)

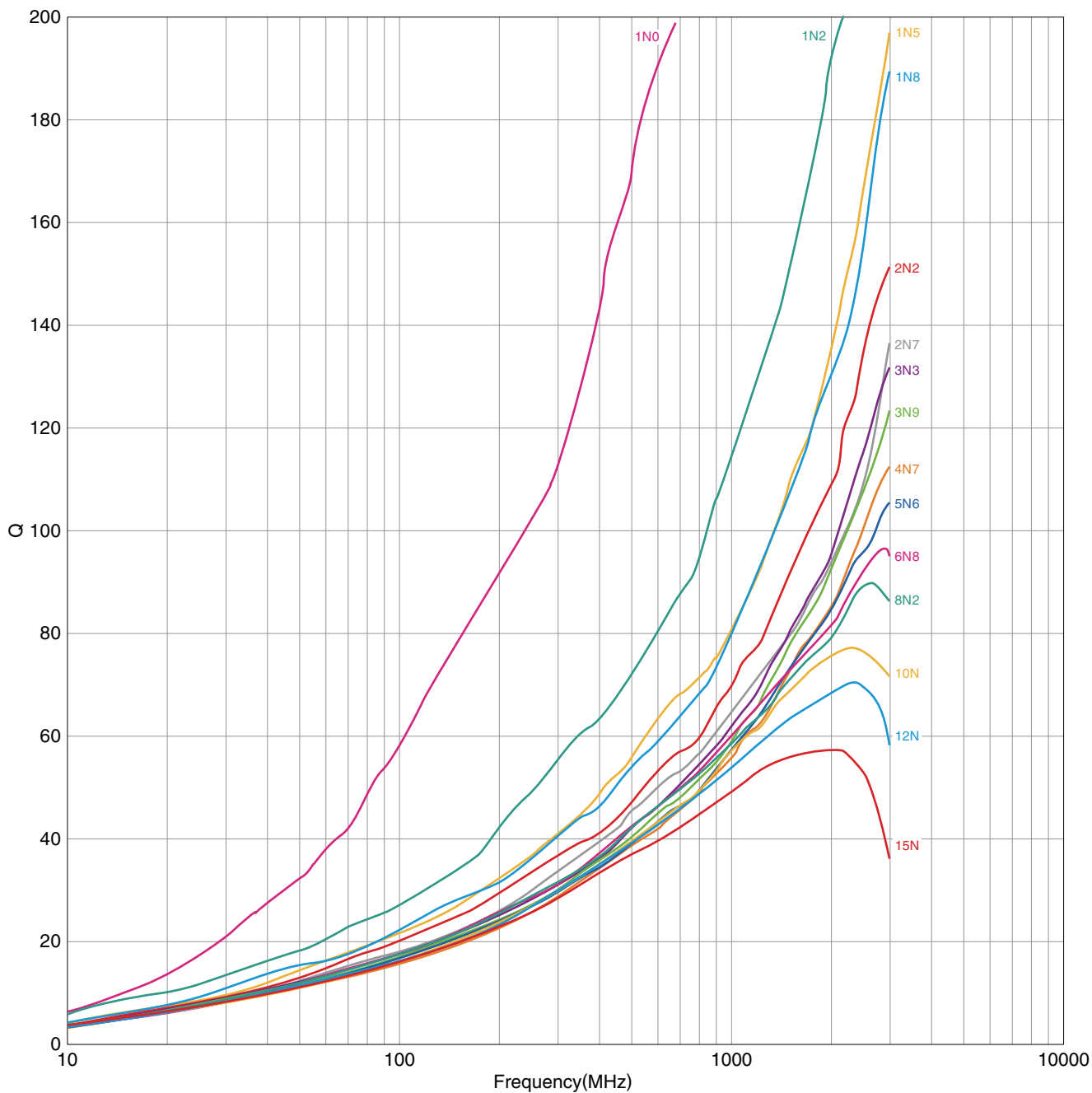

○ Measurement equipment

Product No.	Manufacturer
E4991+16193A	Agilent Technologies

* Equivalent measurement equipment may be used.

• All specifications are subject to change without notice.

MHQ-P_{series}

Packaging Style

REEL DIMENSIONS

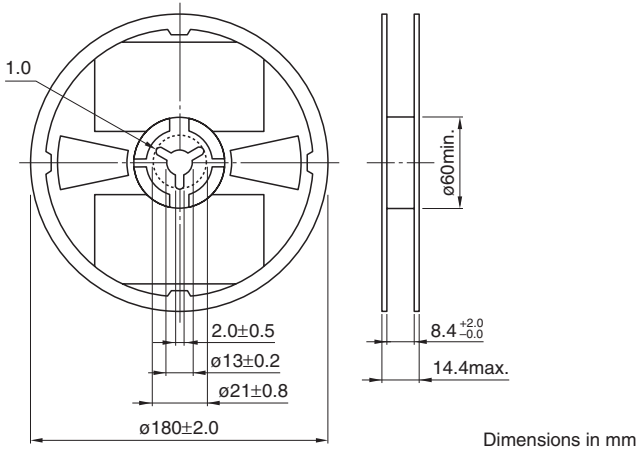

TAPE DIMENSIONS

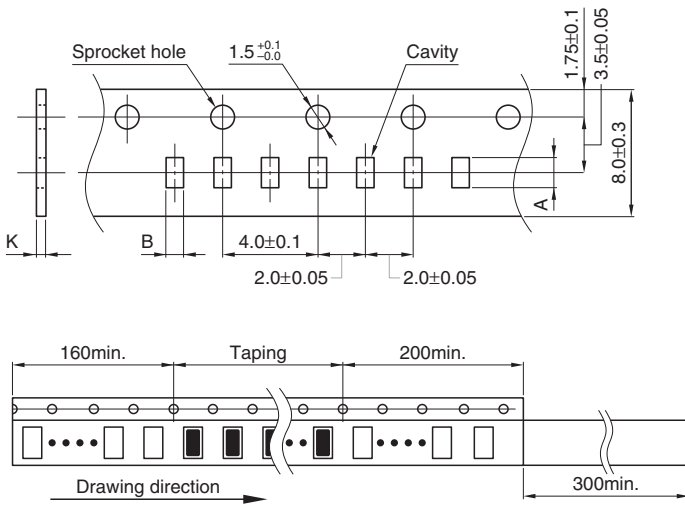

Type	A	B	K
MHQ0603P	0.74±0.05	0.44±0.05	0.60 max.
MHQ1005P	1.15±0.10	0.75±0.10	0.8 max.

• All specifications are subject to change without notice.