

SAW FILTER FOR GPS RF

Murata part number : SAFEB1G57KC0F55

■ Package Dimensions

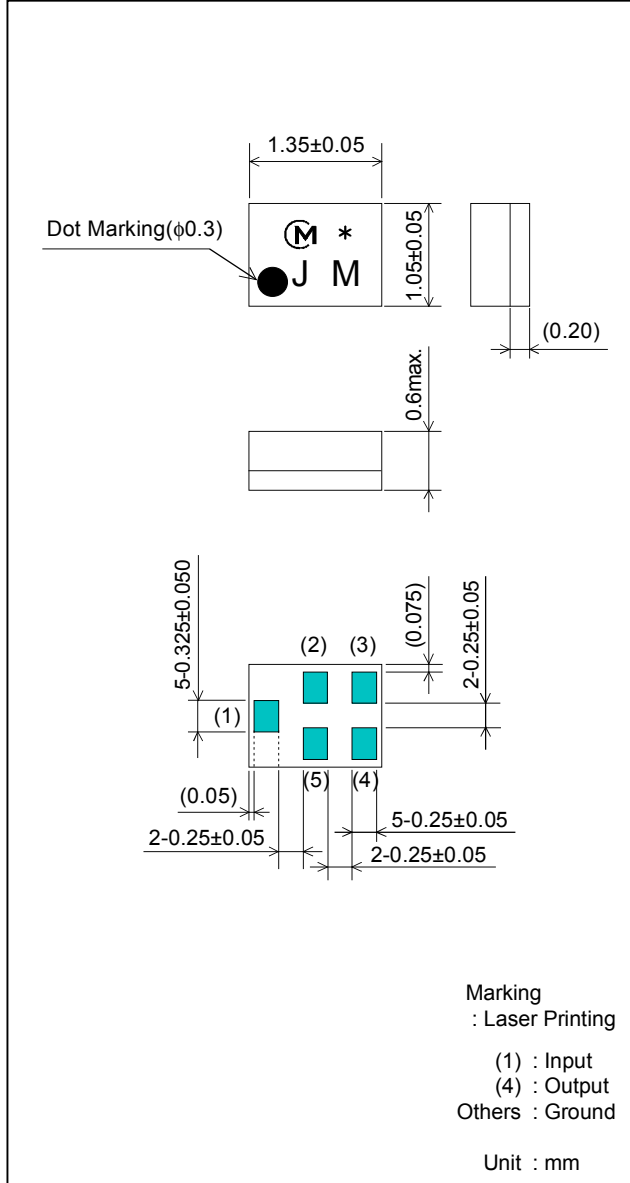

■ Specification

Item	Specification		
	-30 to 85°C	25±2°C	typ.
Nominal Center Frequency(fc)	1575.5MHz		
Insertion Loss (1574 to 1577MHz)	1.5 dB max.	1.4 dB max.	1.1 dB
Absolute Attenuation			
1) 0.1 to 824 MHz	39 dB min.	39 dB min.	42 dB
2) 824 to 960 MHz	40 dB min.	40 dB min.	43 dB
3) 1429 to 1525 MHz	40 dB min.	40 dB min.	43 dB
4) 1626 to 1661 MHz	40 dB min.	40 dB min.	43 dB
5) 1710 to 1980 MHz	40 dB min.	40 dB min.	52 dB
6) 2110 to 2170 MHz	40 dB min.	40 dB min.	44 dB
7) 2170 to 3000 MHz	30 dB min.	30 dB min.	39 dB
Ripple Deviation (1574 to 1577MHz)	0.6 dB max.	0.5 dB max.	0.1 dB
VSWR (1574 to 1577MHz)	1.6 max.	1.5 max.	1.1
Input/Output Impedance (nominal)	50Ω		
Input Signal Level	20mW (+13dBm), 2000 hours		

SAW FILTER FOR GPS RF

Murata part number : SAFEB1G57KC0F55

■ Frequency Performance

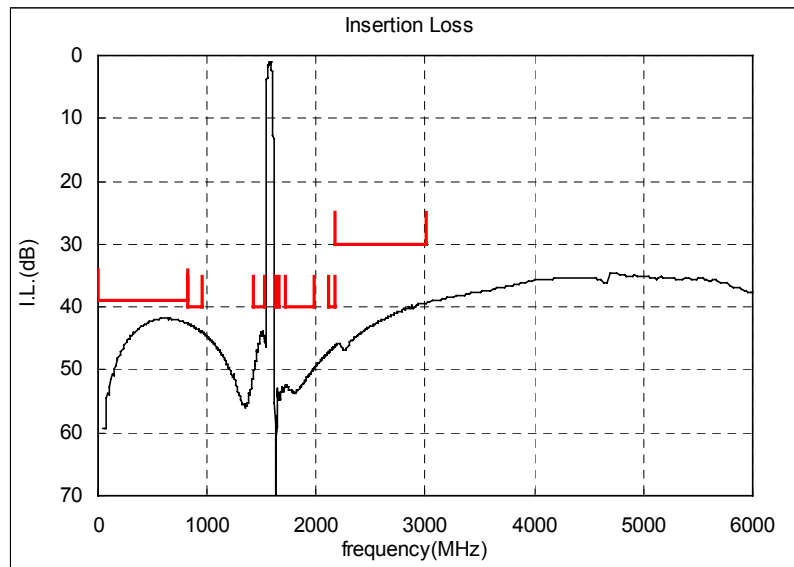
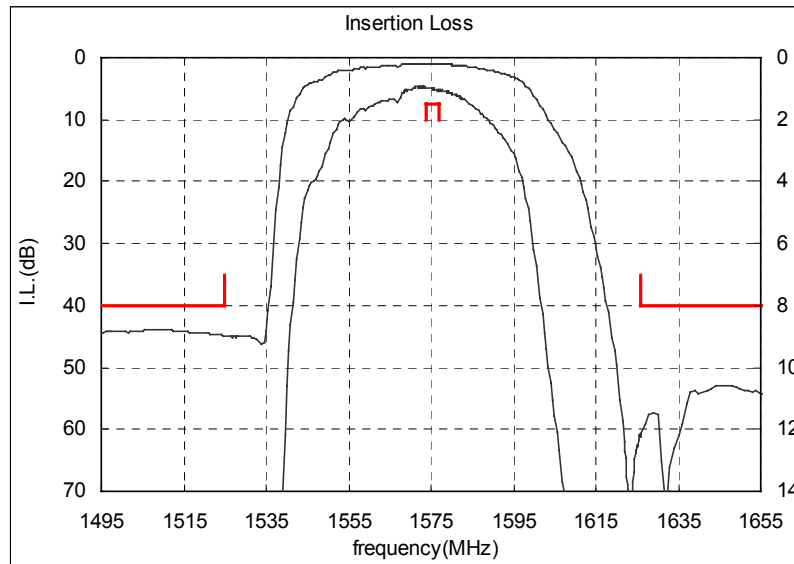

SAW FILTER FOR GPS RF

Murata part number : SAFEB1G57KC0F55

■ Dimensions of Carrier Tape

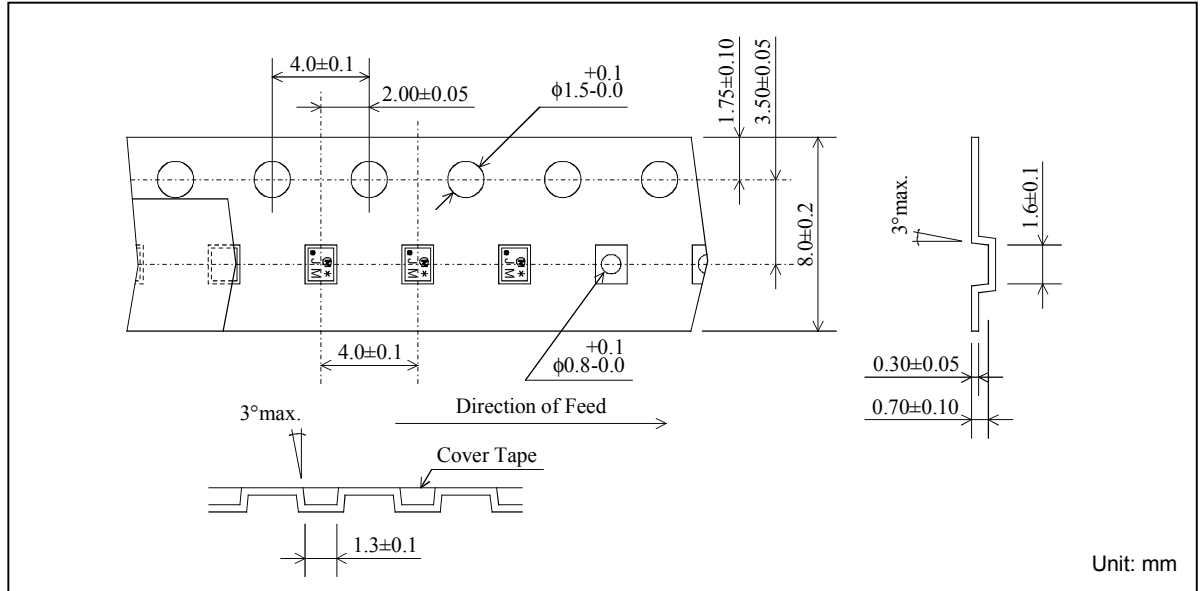

■ Dimensions of Tape

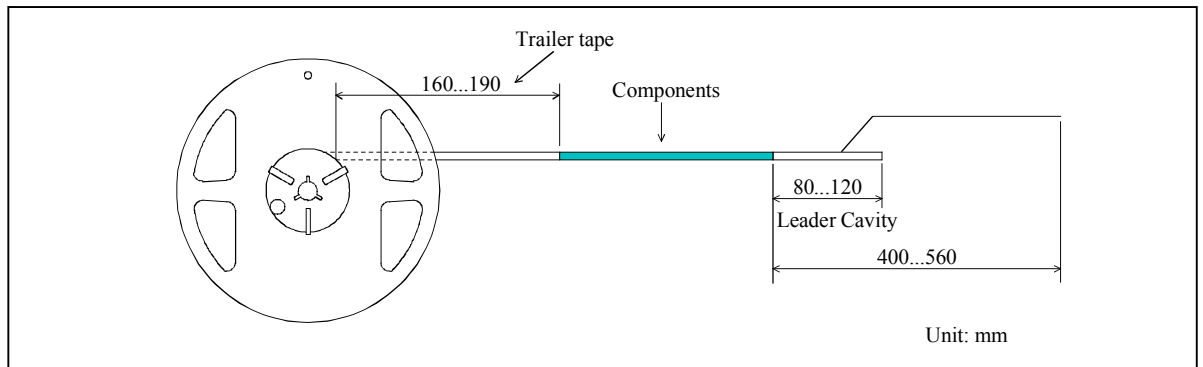

■ Dimensions of Reel

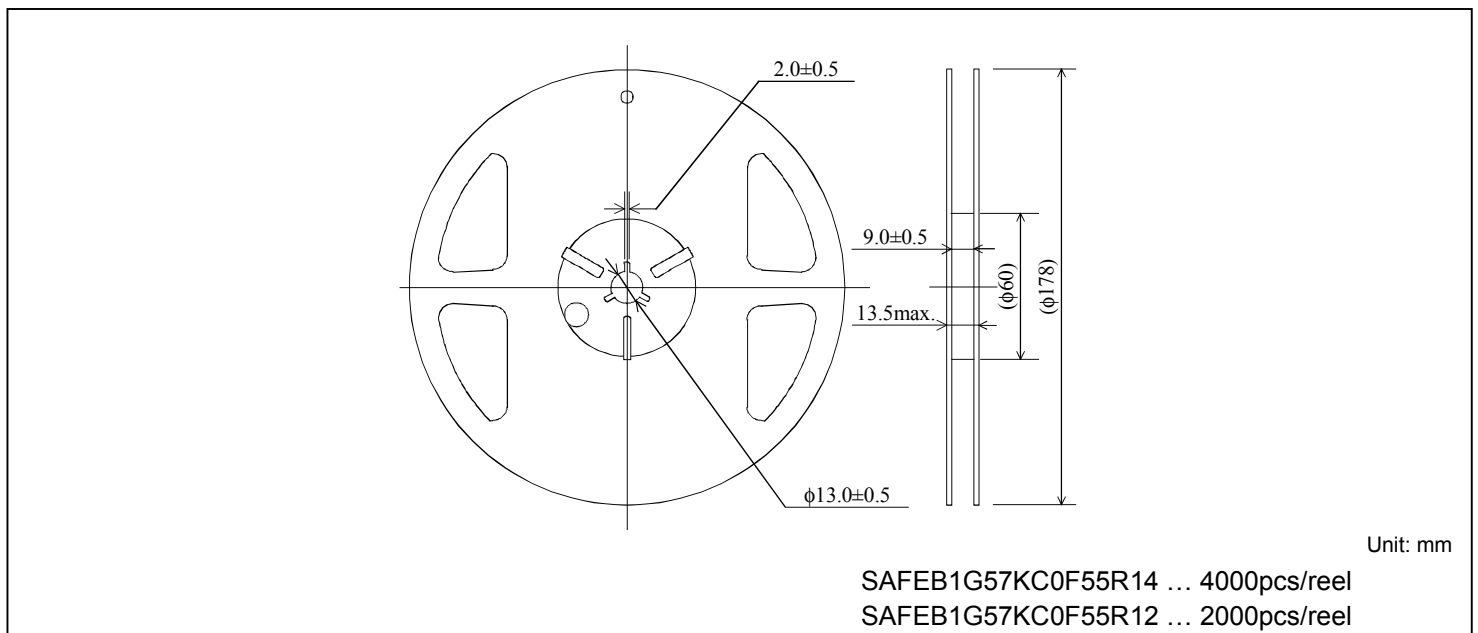

SAW FILTER FOR GPS RF

Murata part number : SAFEB1G57KC0F55

■ Recommended Land Pattern

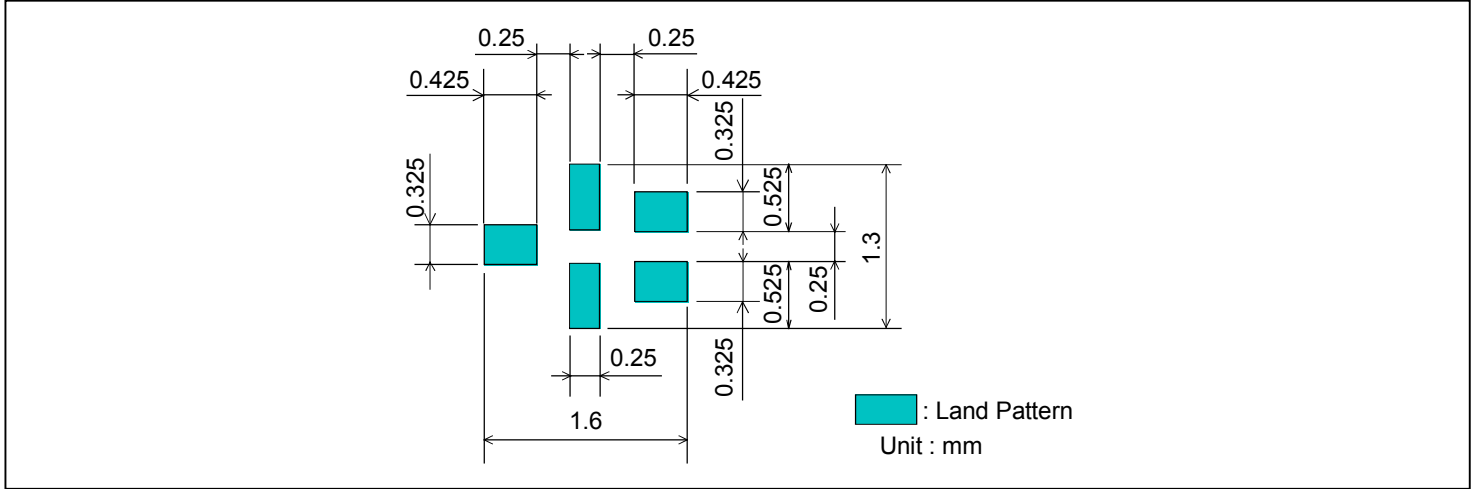

■ Test Circuit

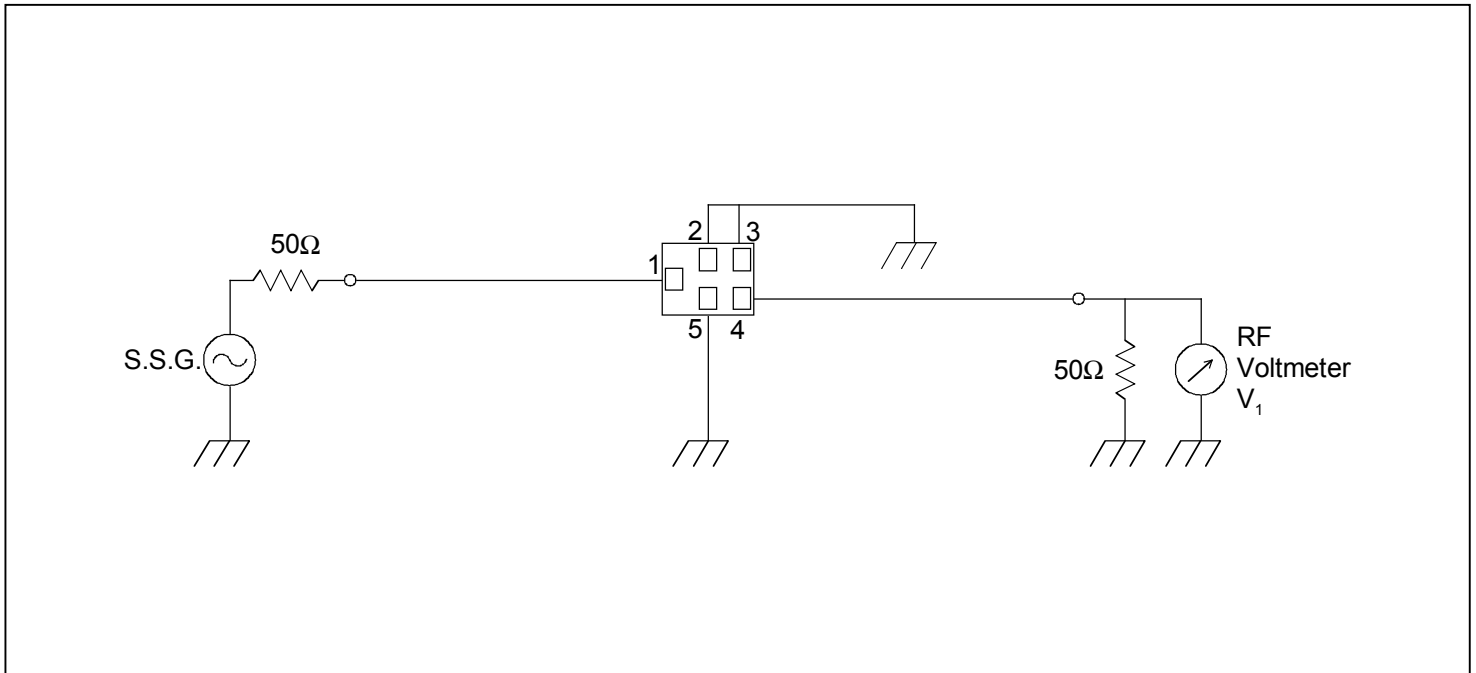

- This PDF Datasheet is downloaded from the website of Murata Manufacturing Co., Ltd. Therefore, it's specifications are subject to change or our products in it may be discontinued without advance notice. Please check with our sales representatives or product engineers before ordering.
- This PDF Datasheet has only typical specifications because there is no space for detailed specifications. Therefore, please approve our product specifications or transact the approval sheet for product specifications before ordering.