

**Two-Piece  
Commercial  
DIN**

.100" (2.54mm) Density  
Style C  
Dip Solder/Wire Wrap/IDC  
Solder Hook/Compliant Pin

**Cinch**

FEATURES

- Available in standard contact configuration of 64 contacts (2 x 32) on .100" x .200" (2.54mm x 5.08mm) centers or 96 contacts (3 x 32) on .100" x .100" (2.54mm x 2.54mm) centers.
- Plug has right-angle dip solder tails.
- Socket available with straight dip solder, wire wrap, mass terminated IDC, or compliant press fit.
- Ideal for mother/daughter PC board interconnections.
- DIN 41612 and VG 95324 approved.
- Meets applicable requirements of MIL-C-55302.

MATERIALS

**Insulation Material:** UL 94V-0 rated glass-filled polyester, gray  
**Contact Material:**  
Plug: Brass  
Socket: Phosphor bronze  
**Contact Plating:** Gold over nickel in contact area, tin on tails,  
DIN Class 3

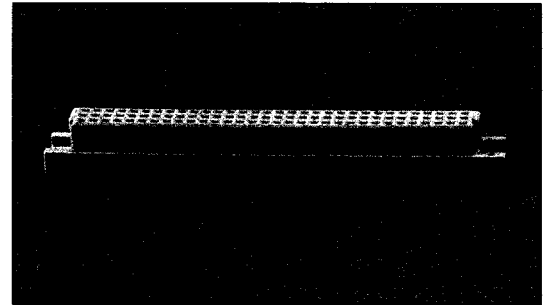

ENVIRONMENTAL

**Shock:** Per MIL-STD-1344, Method 2004  
**Operating Temperature:** -65°C to +125°C  
**Vibration:** Per MIL-STD-1344, Method 2005  
**Humidity:** Per MIL-STD-1344, Method 1002, Type 2



ELECTRICAL

**Withstanding Voltage:** 1000 VAC RMS (@ sea level)  
**Current Rating:** 3 Amps  
**Contact Resistance:** 20 Milliohms maximum  
**Insulation Resistance:** 10,000 Megohms minimum

MECHANICAL

**Individual Contact Insertion and Separation Force:**  
3.2 oz. (89.6 g) maximum; 0.5 oz. (14.0 g) minimum

**Two-Piece  
Commercial  
DIN**

**.100" (2.54mm) Density  
Style C  
Dip Solder/Wire Wrap/IDC  
Solder Hook/Compliant Pin**

**Cinch**

**Dimensions**

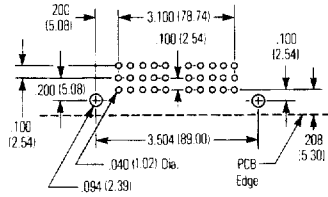

**Plug**

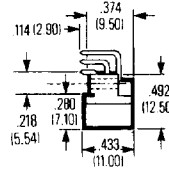
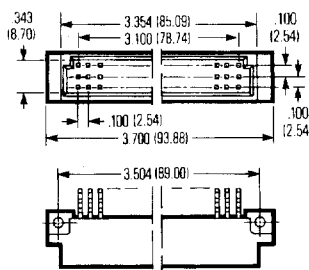

**Socket**

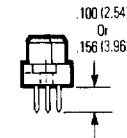
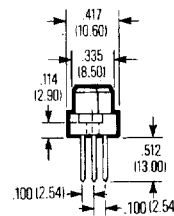
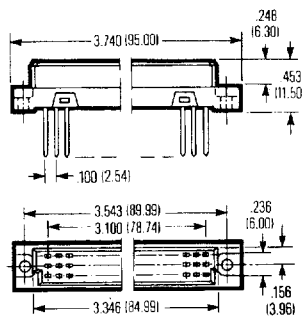
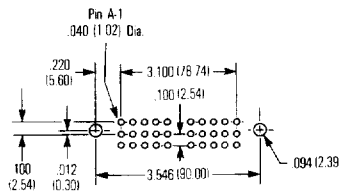

Wire Wrap

Dip Solder

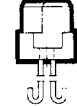

Solder Hook

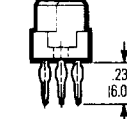

Compliant Pin

**Ordering Information**

No. of Contacts	Right-Angle Dip Solder .114" Long Catalog No.	Wire Wrap .512" Long Catalog No.	Straight Dip Solder .100" (2.54mm) Long Catalog No.
64 Plug	43-1642	-	-
64 Socket	-	43-2643	43-2644
96 Plug	43-1962	-	-
96 Socket	-	43-2963	43-2964

No. of Contacts	Straight Dip Solder .156" (3.96mm) Long Catalog No.	IDC Catalog No.	Compliant Press Fit .236" (6.00mm) Long Catalog No.
64 Plug	-	-	-
64 Socket	43-2645	43-2647	43-2648
96 Plug	-	-	-
96 Socket	43-2965	-	43-2968

No. of Contacts	Solder Hook .315" Long Catalog No.
64 Plug	-
64 Socket	43-2646
96 Plug	-
96 Socket	-

**Socket (Flat Cable IDC)**

