

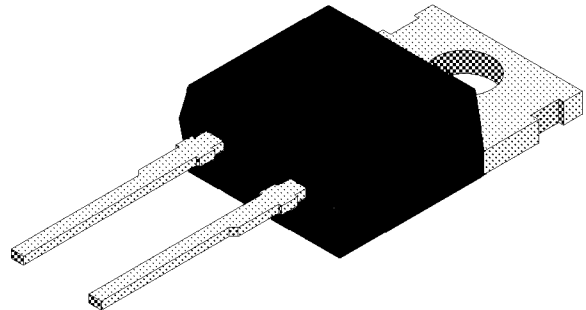

8.0A Super-Fast Glass Passivated Rectifiers

Features

- Glass passivated die construction
- Diffused junction
- Super-fast switching times for high efficiency
- High current capability and low forward voltage drop
- Surge overload rating to 125A peak
- Low reverse leakage current
- Plastic material – UL Recognition flammability classification 94V-0



94 9537

Absolute Maximum Ratings

$T_j = 25^\circ\text{C}$

Parameter	Test Conditions	Type	Symbol	Value	Unit
Repetitive peak reverse voltage =Working peak reverse voltage =DC Blocking voltage		STPR805DF	V_{RRM} $=V_{RWM}$ $=V_R$	50	V
		STPR810DF		100	V
		STPR815DF		150	V
		STPR820DF		200	V
		STPR830DF		300	V
		STPR840DF		400	V
		STPR850DF		500	V
		STPR860DF		600	V
Peak forward surge current			I_{FSM}	125	A
Average forward current	$T_C=100^\circ\text{C}$		I_{FAV}	8	A
Junction and storage temperature range			$T_j=T_{stg}$	-65...+150	$^\circ\text{C}$

Electrical Characteristics

$T_j = 25^\circ\text{C}$

Parameter	Test Conditions	Type	Symbol	Min	Typ	Max	Unit
Forward voltage	$I_F=8\text{A}$	STPR805DF–820DF	V_F			0.95	V
		STPR830DF–840DF	V_F			1.3	V
		STPR850DF–860DF	V_F			1.5	V
Reverse current	$T_C=25^\circ\text{C}$		I_R			5	μA
	$T_C=100^\circ\text{C}$		I_R			500	μA
Reverse recovery time	$I_F=1\text{A}, I_R=0.5\text{A}, I_{rr}=0.25\text{A}$	STPR805DF–820DF	t_{rr}			35	ns
		STPR830DF–860DF	t_{rr}			50	ns
Diode capacitance	$V_R=4\text{V}, f=1\text{MHz}$	STPR805DF–840DF	C_D		85		pF
		STPR850DF–860DF	C_D		60		pF
Thermal resistance junction to case			R_{thJC}		6.3		K/W



Characteristics ($T_j = 25^\circ\text{C}$ unless otherwise specified)

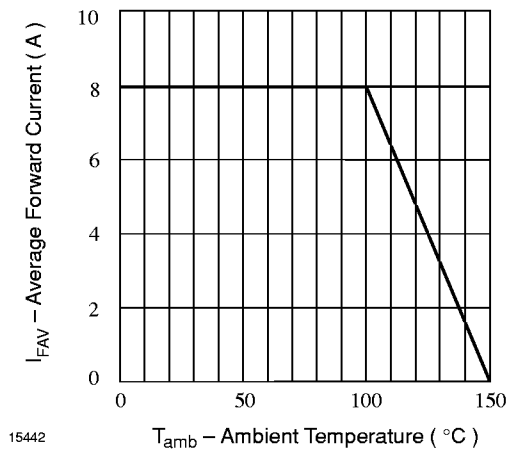

Figure 1. Max. Average Forward Current vs. Ambient Temperature

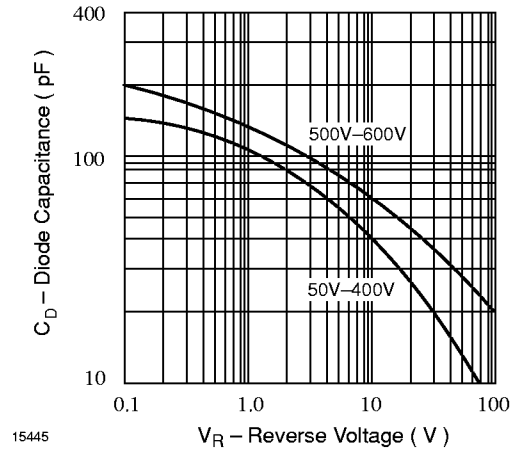

Figure 4. Typ. Diode Capacitance vs. Reverse Voltage

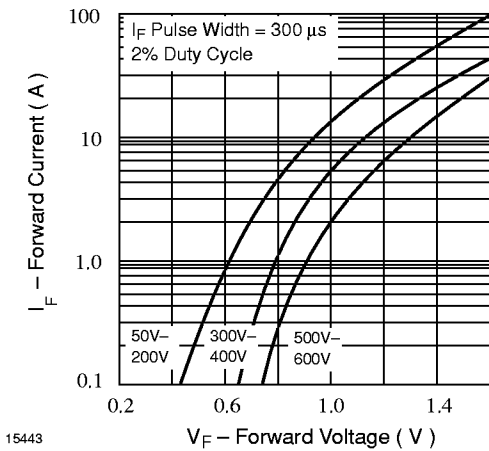

Figure 2. Typ. Forward Current vs. Forward Voltage

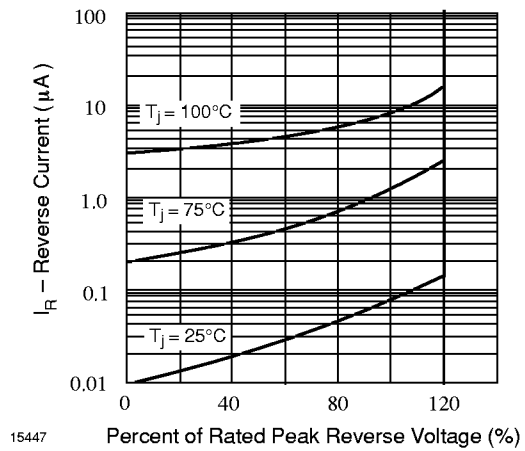

Figure 5. Typ. Reverse Current vs. Percent of Rated Peak Reverse Voltage

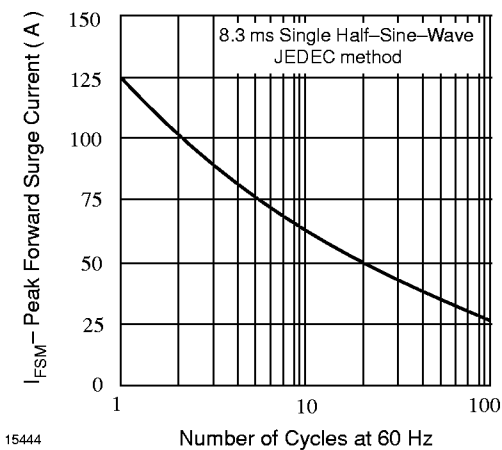

Figure 3. Max. Peak Forward Surge Current vs. Number of Cycles



STPR805DF-STPR860DF

Vishay Lite-On Power Semiconductor

Dimensions in mm

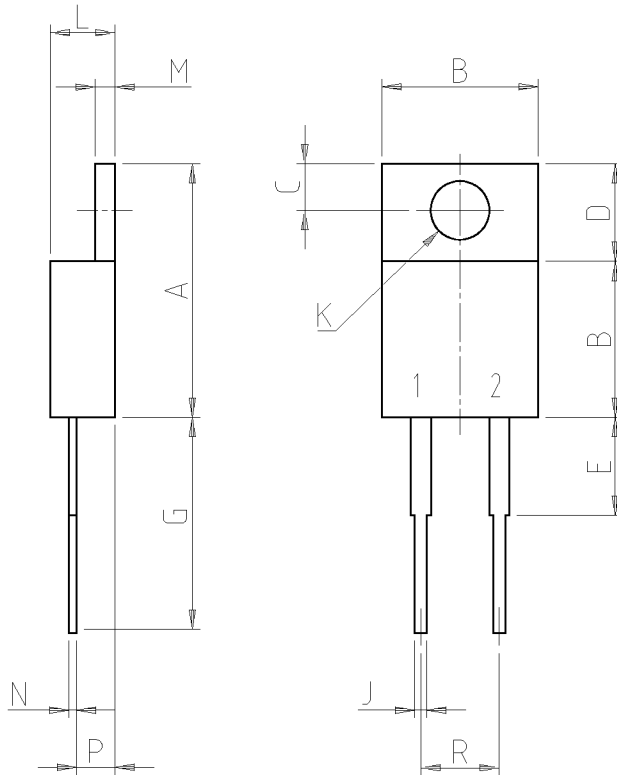

TO-220AC		
Dim	Min	Max
A	14.22	15.88
B	9.65	10.67
C	2.54	3.43
D	5.84	6.86
E	-	6.25
G	12.70	14.73
J	0.51	1.14
K	∅3.53	∅4.09
L	3.56	4.83
M	1.14	1.40
N	0.30	0.64
P	2.03	2.92
R	4.83	5.33
All Dimensions in mm		

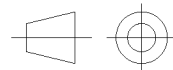
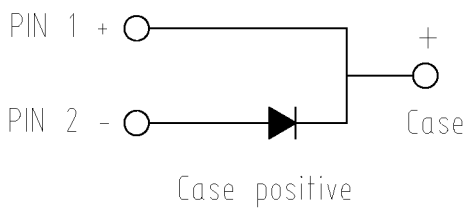

technical drawings
according to DIN
specifications

14469

Case: molded plastic
Polarity: see diagram
Approx. weight: 2.24 grams
Mounting position: any
Marking: type number



Ozone Depleting Substances Policy Statement

It is the policy of **Vishay Semiconductor GmbH** to

1. Meet all present and future national and international statutory requirements.
2. Regularly and continuously improve the performance of our products, processes, distribution and operating systems with respect to their impact on the health and safety of our employees and the public, as well as their impact on the environment.

It is particular concern to control or eliminate releases of those substances into the atmosphere which are known as ozone depleting substances (ODSs).

The Montreal Protocol (1987) and its London Amendments (1990) intend to severely restrict the use of ODSs and forbid their use within the next ten years. Various national and international initiatives are pressing for an earlier ban on these substances.

Vishay Semiconductor GmbH has been able to use its policy of continuous improvements to eliminate the use of ODSs listed in the following documents.

1. Annex A, B and list of transitional substances of the Montreal Protocol and the London Amendments respectively
2. Class I and II ozone depleting substances in the Clean Air Act Amendments of 1990 by the Environmental Protection Agency (EPA) in the USA
3. Council Decision 88/540/EEC and 91/690/EEC Annex A, B and C (transitional substances) respectively.

Vishay Semiconductor GmbH can certify that our semiconductors are not manufactured with ozone depleting substances and do not contain such substances.

We reserve the right to make changes to improve technical design and may do so without further notice.

Parameters can vary in different applications. All operating parameters must be validated for each customer application by the customer. Should the buyer use Vishay-Telefunken products for any unintended or unauthorized application, the buyer shall indemnify Vishay-Telefunken against all claims, costs, damages, and expenses, arising out of, directly or indirectly, any claim of personal damage, injury or death associated with such unintended or unauthorized use.

Vishay Semiconductor GmbH, P.O.B. 3535, D-74025 Heilbronn, Germany
Telephone: 49 (0)7131 67 2831, Fax number: 49 (0)7131 67 2423