

Powerpole® & Multipole

CONNECTORS | 10 AMPS UP TO 700 AMPS

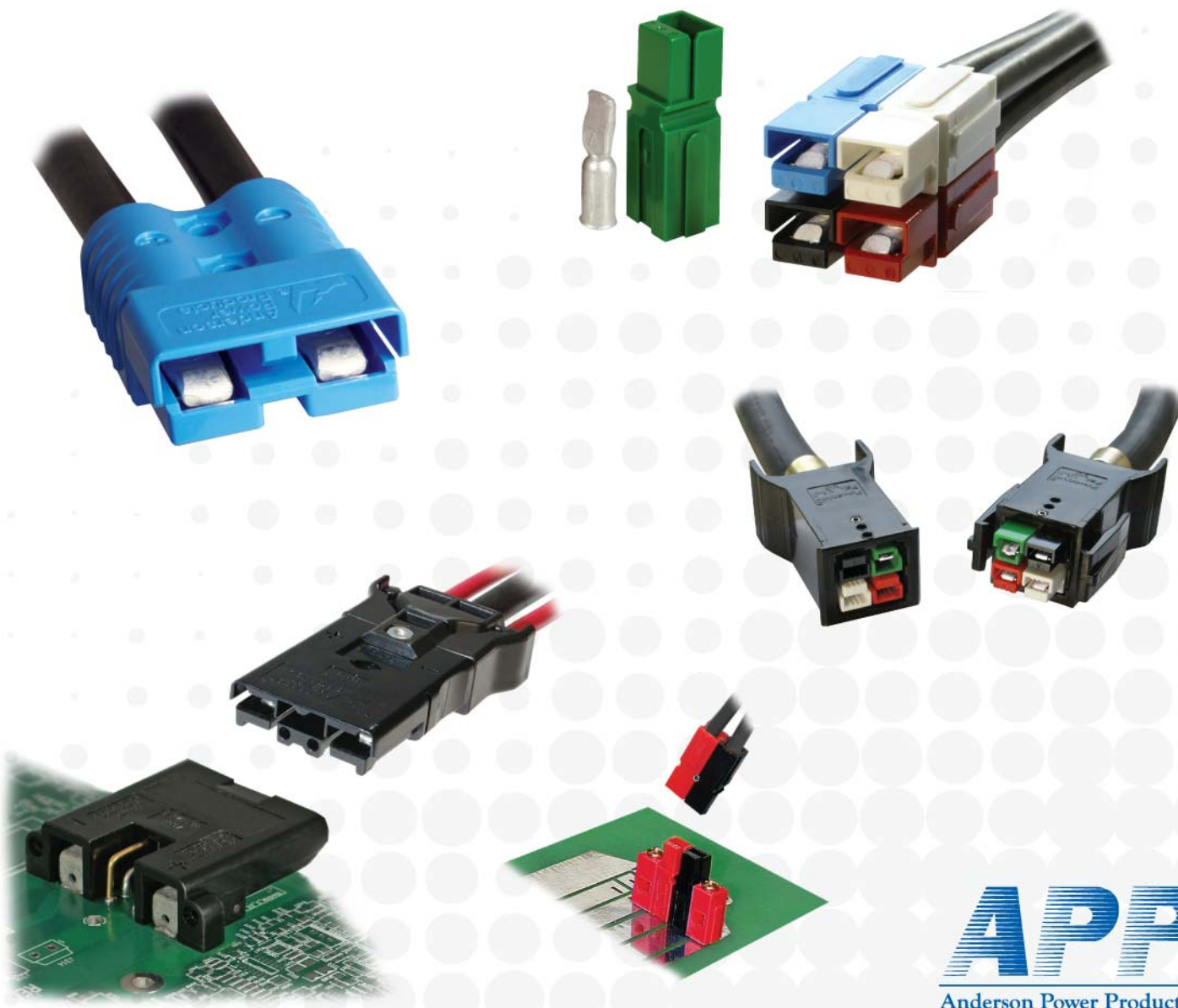

Alternate Energy | Power Electronics | Electric Vehicles | Telecommunications | Industrial | PCB



Legal Info & Global Presence

APP® Global Distribution Network Includes the Following Countries Along With Many Others:

Argentina, Australia, Belgium, Brazil, Canada, Chile, China, Columbia, Denmark, France, Germany, Greece, Hong Kong, Ireland, Israel, Italy, Japan, Mexico, New Zealand, Norway, Peru, Poland, Portugal, Singapore, Slovenia, South Africa, South Korea, Spain, Switzerland, Thailand, Turkey, United Kingdom and United States.

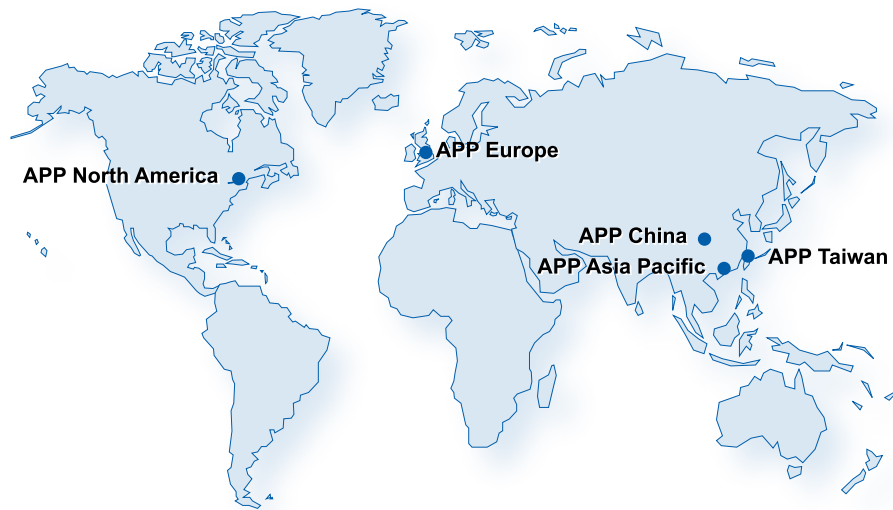

APP®'s philosophy is to provide products and services within the trading markets of our customers. We currently serve our worldwide customer base from customer support and manufacturing facilities in Sterling, MA, U.S.A., Warrington UK for European customers, as well as three Asia Pacific facilities: Shenzhen, China, Shatin Hong Kong and Taichung City 407, Taiwan (R.O.C.).

Today, as a result of innovative design and development, APP® has evolved into a valued supplier for a wide variety of markets including Back-up Power, Telecom / Datacom, Alternative Energy Generation & Distribution, Medical Equipment, Defense, and the Material Handling Industries.

APP® has established a reputation for high quality products, on-time deliveries, and excellent customer service. As a result of modern manufacturing techniques and rigorous quality control measures, APP® assures customers receive the quality products they deserve.

As a global company dedicated to best environmental practice, APP® has taken steps to meet the RoHS directive for virtually all products. The RoHS status for individual APP® products is readily accessible to customers twenty-four hours a day, seven days a week online. APP® looks forward to the challenges posed by the new technologies of the future and will continue its century long tradition of design excellence and superior customer support to meet customers' needs.

.....
Anderson Power Products® may revise terms and conditions from time to time without notice. APP® maintains this catalog as a service to its customers. The entire content (images and text) is ©copyrighted 2012 and may not be distributed, downloaded, modified, reused, reposted, or otherwise used, except as provided herein, without the express written permission of APP®. You may use and download the content only for your personal, non-commercial use.

APP® will use reasonable efforts to include accurate and up-to-date content in the catalog. All product information contained in the catalog including ordering information, illustrations, specifications, and dimensions, are believed to be reliable as of the date of publishing, but is subject to change without notice. APP® makes no warranty or representation as to its accuracy. Content in the catalog may contain technical inaccuracies, typographical errors and may be changed or updated without notice. APP® may also make improvements and/or changes to the products and/or to the programs described in the content at any time without notice. Current sales drawings and specifications are available upon request.

Neither APP® nor any party involved in creating, producing, or delivering this catalog shall be liable for any direct, incidental, consequential, indirect, or punitive damages arising out of your use of this catalog or any errors or omissions in its content.

All product names, whether or not appearing in large print or with the trademark symbol, including, but not limited to A, A in circle, Anderson Power Products, Anderson, APP, Powerpole, SB, SBE, SBO, SBS, SBX, SPEC Pak, Saf-D-Grid, Power Clip, Power Drawer, PowerMod, are trademarks of APP, its affiliates, related companies, licensors, and/or joint venture partners. The use or misuse of these trademarks, or any other content of this catalog, except as permitted herein, is expressly prohibited and may be in violation of intellectual property laws, which shall be aggressively enforced.

Index & Product Selector Guide

SECTION 1

- Index & Product Selector 1
- Technical Reference 4
- Glossary 10
- Engineering Reference 12

SECTION 2

- Powerpole® Connectors 16
 - PP15 to PP45 20
 - Powerpole® Pak 23
 - Powerpole® PP75 30
 - Powerpole® PP120 36
 - Powerpole® PP180 39

SECTION 3

- Multipole Connectors 44
 - SBS® 49
 - SB®50 57
 - SB®120 62
 - SB®175 66
 - SB®350 71
 - SBE®80 / SBO®60 77
 - SBE®160 / SBX®175 82
 - SBE®320 / SBX®350 88

SECTION 4

- Tooling 95

SECTION 5

- Part Number Page Reference 101

	Powerpole® Connector Family	Multipole Connector Family
Page Number	16	44
Amps (UL) Per Pole	Up to 350	Up to 450
Volts (UL) Per Pole	Up to 600	Up to 600
Wire Gauge (AWG)	20 - 3/0	16 - 300 mcm
Wire Gauge (mm ²)	0.5 - 85.0	1.3 - 152
Number of Power Circuits	1 / Stackable	2 - 3 / Not Stackable
Ground	•	•
Auxiliary		•
PCB Mount	•	•
Bus Bar	•	•
Panel Mount	•	•
Blind Mate	•	
Hot Plug	•	•
Touch Safe	•	•
Strain Relief	•	•
Polarized Housing	•	•
Mechanically Keyed		•
Latching	•	
Handle		•
Air Supply System		•

APP Custom Connector Capabilities

Anderson Power Products® specializes in design and manufacture of high current connection systems to meet specific customer needs. Our expertise in high amperage connections, multiple types of contact technology, and molded plastic insulators allow us to provide durable, high power connections that fulfill the project requirements of OEM's.

We look forward to working with OEM's on their manufacturing scale projects to provide connector solutions which our current product portfolio may not satisfy. APP® Marketing, Engineering, Quality, Safety Agency, and Manufacturing teams all contribute through the integrated product development process to create and deliver custom connectors that exceed our customers' needs and meet APP® high standards.

Contact your local customer service representative or regional sales manager to explore how APP® custom design and manufacturing capabilities can meet your high volume connection needs.



| How to Use this Catalog |

The information in this catalog is provided in layers to allow you to quickly find the information you are looking for.

- 1) Selection Guides are featured at the front of the catalog and at the beginning of each product section to enable quick connector selection by electrical attributes and other features.
- 2) A Technical Reference is provided to give important information common to all connectors in this catalog. Answers to common questions, definitions of terminology, and technical charts are all included.
- 3) Overviews at the beginning of each product main section describe the similarities and call out common features of products within that section.
- 4) Introductions to the features and benefits of each product are supplied at the beginning of each sub-product section (SB®50, SB®120, etc).
- 5) Specifications and Temperature Charts are shown after the main connector components in each sub-product section to provide detailed technical information (SB®50, SB®120, etc).
- 6) Tooling Charts are provided at the end of each connector family (SB®, SBS® etc) to quickly identify the correct tooling.

| Product Selection Worksheet |

Prior to selecting an interconnect solution from Anderson Power Products®, we recommend you gather the following information. This will aid you in quickly identifying the best product for your particular need.

Amps

Continuous _____ max amps at _____ volts
 Peak _____ max amps _____ seconds

Temperature

Operating _____ Storage _____

Circuit Definition

	Number of Circuits:	Wire Gauge:
Power	_____	_____
Ground	_____	_____
Auxiliary	_____	_____
Other	_____	_____

Application

- PCB to PCB
- Wire to PCB
- Wire to Bus Bar
- Wire to Wire
- Wire to Panel
- Other _____

Mounting Method (if applicable)

- PCB
- Panel
- Blind Mate

Contacts

- Mating Cycles _____
- Individual
- Reeled
- Tin
- Silver
- Gold
- Straight
- Right Angle

Other Features

- Hot Plug
- Touch Safe per _____
- Flame Resistance per _____
- IP rating of _____
- Sequencing
- Strain Relief
- Polarized Housing
- Mechanical Housing Key
- Latching
- Handle
- Other _____

NOTES:	

Technical Reference

| General Application Notes |

There are common considerations when using APP® connectors. Additional considerations may apply based on the particular connector being used, the application, and conditions in which the connector is being used. This information is intended to provide a basic understanding and is provided for reference only. APP® connectors should be assembled and used according to the equipment manufacturer's instructions, as well as in compliance with local and international electrical codes.

The maximum amperage ratings provided in the specifications are based on use of APP® recommended assembly tooling and the maximum wire size for the connector being used. Amperage ratings are based on not exceeding the maximum operating temperature of the connector housing, factoring in an ambient temperature of 25°C or 77°F. A wire with an appropriate insulation temperature rating should be selected to meet or exceed the total connector temperature (heat rise + ambient).

As an example: if the maximum operating temperature for a connector operation is 105°C and the ambient temperature is 25°C, the maximum heat rise attributable to the connector is 105°C - 25°C = 80°C. The expected heat rise based on the connector and wire size used can be estimated using the heat rise charts, but should be confirmed by testing in the specific application with the specific wire to be used.

Connector devices are rated or derated by the wiring configuration and the environment. Factors to be considered include: enclosure characteristics, connector housing and wire insulation characteristics, number of wires in an enclosed area such as a raceway or conduit, as well as the ambient temperature.

Underwriter Laboratories Inc. amperage ratings are based on not exceeding the maximum operating temperature of the connector housing. This means connectors can be extremely hot when used at the UL amperage ratings. For this reason UL amperage ratings should only be applied to connectors when they are used inside an enclosure not accessible to untrained persons. Canadian Standards Association ratings are based on not exceeding a 30°C temperature rise above ambient temperatures. For this reason CSA amp ratings are a good point of reference for connectors that are user operated. APP® does not recommend exceeding a 30°C temperature rise above ambient temperatures for connections accessible during operation to untrained persons.

| How to Read Temperature Charts |

Temperature Rise at Constant Current Charts

Temperature Rise at Constant Current charts show the associated heat rise as a result of applied current to the connector. An example of the SB®50 Temperature Rise chart is included to follow along with this explanation.

The chart is based on an ambient temperature of 25°C (77°F room temperature). Accordingly if the temperature °C on the Y axis of the chart is at 30°C, the expected total connector temperature would be 55°C.

Separate curves are shown for #6, #8, #10, and #12 AWG wire. Interpreting the curves, if 50 amps are applied continuously to the connector, the heat rise will be 23°C for #6, 35°C for #8, 55°C for #10, and #12 wire is not suitable for this amperage.

Where T = Temperature, heat rise is expressed as a ΔT °C.
T ambient - T (ambient + heat from applied current) = ΔT °C.

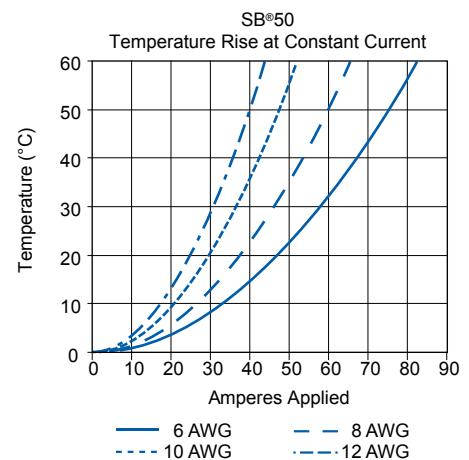

Derating vs. Ambient Temperature Charts

Derating vs. Ambient Temperature charts show the maximum amperage capability of a connector at a given ambient temperature. An example of the SB[®]50 chart is included to follow along with this explanation.

All data points are based on the maximum operating temperature of the connector, most often 105°C or 221°F. Accordingly if the temperature °C on the Y axis of the chart is at 105°C, there is no amperage capability because the connector housing is already at the maximum operating temperature.

Separate curves are shown for #6, #8, #10, and #12 AWG wire. Interpreting the curves, at a 75°C ambient temperature the maximum amperage capability that can be applied continuously to the connector is: 58A for #6, 46A for #8, 37A for #10, and 31A for #12 wire.

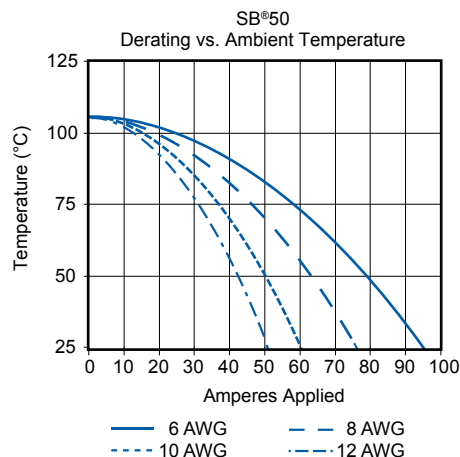

Notes on Temperature Rise Charts

Note that these charts are constructed using calculations based on actual test data. For this reason the chart information may vary slightly from the safety agency ratings. Safety agency ratings and compliance with electrical codes take precedent over these charts. The charts are designed to provide a guideline as to the connectors' capability. Actual results can vary based on the specific wire used, crimp tooling and assembly, as well as the environment the connector is used in.

CSA ratings are based on not exceeding a 30°C temperature rise above ambient or a total temperature of 55°C. This is considered the maximum temperature to safely handle a connector at. UL ratings can be based on the operating temperature limit of the connector. Often for APP[®] connectors this is 105°C or an 80°C temperature rise above an ambient temperature of 25°C. To provide a margin of safety, the heat rise charts are limited to a 60°C temperature rise.

| Compatible Wires |



APP[®] connectors are designed to be crimped and/or soldered to multi-stranded copper conductor wires only. Alternate conductor materials including aluminum should not be used. Aluminum conductors crimped into APP[®] contacts can result in a galvanic reaction occurring between the aluminum wire and the more cathodic metals used in APP[®] contacts including copper, tin, silver, and gold. Additionally softer metals like aluminum flow or loosen from crimps much easier than copper.

Multi-stranded wire is recommended for all APP[®] connectors and is required when crimp terminating wires or when a connector with flat wiping contact technology is used (such as Powerpole[®] and SB[®]). Solid wires do not adequately compress and retain in crimp barrels after being crimped. For this reason if solid wire is used, it should be with solder termination only.

Solid wires also do not flex and bend as easily as multi-stranded equivalents and can act as a lever arm and impede or alter the natural state of a flat wiping contact in the housing. This impediment or alteration to the flat wiping contact's natural state can cause intermittency and shorts as well as higher resistance and temperature at a given amperage than is shown in APP[®] specifications. Mating and unmating forces may also be impacted.

| Different Contact Technologies |

Flat Wiping:

- Same contacts on the “male” and “female” side reduce inventory costs and increase ease of assembly.
- Low resistance connection has a large conducting surface and a high normal force in comparison to typical pin and socket contacts.
- Sacrificial tip confines damage to non-conducting area when mating or breaking under load.
- Raised surface on the mating side of the contacts secures the connector in the mated condition, limiting the need for latching on outer housings.
- Over wiping design cleans the mating surface when mating and unmating.

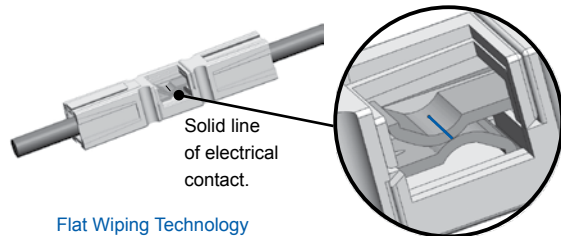

- VS -

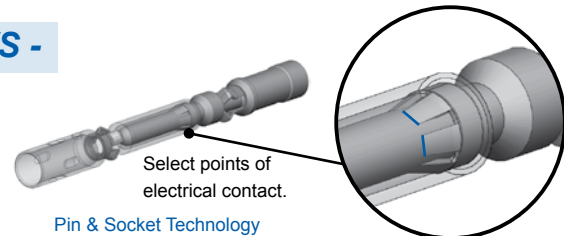

Pin & Socket:

- Different contacts on male and female sides. Female socket contacts are typically more expensive than the simple geometries of the pin contacts.
- Often higher resistance than flat wiping connectors of the same wire size and plating due to the reduced mating surface area and lower normal force. Gold plating often used to compensate and minimize resistance.
- Best for compact connection needs such as signal and low power due to static position in housings and symmetrical shape.
- Socket contacts can catch and hold debris inside the socket body causing mating problems.

| Use of APP® Connectors in Applications Exceeding 600V |

The approved voltage ratings for APP® connectors are usually limited by the category under which a safety agency such as UL approves our connector for use. UL typically defers to National Electric Code (NEC) on the voltage limitations for any given device our connector could be used in. For most common applications NEC restricts voltage to a maximum of 600V AC or DC which is what our connector voltage ratings are based on.

To achieve UL 1977 approval for a 600V rating, we test our connectors for dielectric withstanding voltage. The connector is tested at 2 times the rated voltage of 600V plus 1000V or 2200VAC for 1 minute. For applications exceeding 600V, UL / NEC / IEC may require application specific review for creepage and clearance resistance.

| Frequently Asked Questions |

Q: Can I cross mate low and high mating force contacts?

A: Yes, however this would not be a connection solution we have tested for safety agency approval. Additionally the contacts may wear at an accelerated rate causing the mating cycle rating to be reduced. The mating and unmating force expected would be somewhere in between the high and low mating force specification.

Q: Can I crimp multiple wires into 1 crimp barrel?

A: Yes, however this would not be a connection solution we have tested for safety agency approval. Particular care should be used that the bundle of wires do not interfere with the movement of the contact in the housing during mating and unmating (see maximum wire O.D. specification). The total circular mils of all conductor strands should be within + or – 5% of the wire size the contact is intended for. Twist the conductor strands together and crimp using APP® tooling with range taking capabilities such as the 1368 series. To crimp with other APP® recommended tools, contact customer service for the recommended setting or die and locator combination.

Q: Will the crimp tool I have for standard color-coded lugs, Mil Spec contacts, or another connector manufacturer, work for crimping APP® contacts?

A: No. APP® contacts generally do not conform to standard crimp barrel dimensions used for lugs, Mil Spec contacts, or other connector manufacturers. The tooling recommended by APP® must be used to ensure the performance designed by APP® is achieved. Alternate tooling will void APP® warranties and can affect safety agency approvals. In some instances Mil Spec tools are approved for crimping contacts with the dies and locators recommended by APP®. See tooling charts for specific instances, or contact customer service for more information.

Q: Can metric sized wires be used with APP® contacts?

A: Yes. The majority of our crimp tooling recommendations are based on testing and verification we have performed with AWG sized cables. Metric cables of the same or slightly smaller circular mils equivalent to the AWG wire recommended can typically be successfully terminated in APP® contacts. There is a wire conversion chart at the end of this catalog section that can be used as a reference when converting AWG to mm² sizes. The 1368 series crimp tooling has a range taking capability that produces a reliable crimp with metric equivalents of AWG cables. Please contact customer service for metric tooling recommendations for other APP® crimp tools.

Q: Are APP® connectors suitable for use in applications where the voltage exceeds 600V AC/DC?

A: Possibly. See “Use of APP® Connectors in Applications Exceeding 600V”, contact customer service with further questions.

Q: How do Powerpole® and Multipole connectors stay securely mated without latches?

A: The proven flat wiping technology used in these connectors features a detent or bump in the contact surface along with powerful stainless steel springs that hold the connectors in the mated position. High mating force contacts have a detent that is raised higher than low mating force contacts. The higher the detent, the more force is required to mate and unmate the contacts. In many applications the detent and spring force is enough to securely hold the connectors in the mated position without the need for latches. Latching shells, clips, or other external devices can be used to secure flat wiping connectors in applications where shock, vibration, or cable strain may overcome the inherent force holding the connectors together.

Q: How does APP®'s genderless connector design work to make a mated pair.

A: Genderless Powerpole® and Multipole housings do not have a male(pin) and female(socket) side. For wire-to-wire applications the exact same housings and contacts are used on both sides of the mated pair. If your application calls for wire-to-PCB or wire-to-busbar connections then different contacts and possibly housings will be required on each half (similar to male and female connectors).

To make a mated pair of Powerpole® or Multipole connectors simply assemble the connectors closely following the assembly instructions. After each connector half is fully assembled take one half and flip it over. The two halves will mate together. Multi-row Powerpole® assemblies will need to be stacked in mirror images of each other to properly mate the correct circuits. This information is detailed at the beginning of the Powerpole® section.

| Touch Safety & Ingress Protection (IP) |

UL 1977 Section 10.2:

Typically required for applications where the connector is external to the end device and operating over 30V or 200A, where wet conditions may be present (600V category).

Testing is performed using a probe that mimics a child's finger. All features of the connector are tested for live parts in the unmated state (no pressure applied). A smaller 3 mm probe is then applied in the mated state to test for live parts. Note that some applications may require the connector to not expose live parts to the 3 mm probe in the mating interface.

IEC 60950:

From the standard for Information Technology Equipment Safety, the requirements are harmonized with UL1950. Typically required for commercial and industrial applications where operators may need some degree of protection while accessing or servicing equipment.

Testing is performed using a probe that mimics an adult finger. All features of the connector are tested for live parts in the unmated state with 30 N of force applied to the probe.

IEC 60529:

Standard for Degrees of Protection Provided by Enclosures is harmonized with EN 60529.

Protection degree number is assigned to both solids and liquids in that order. For example: a connector with an IP20 rating is protected against fingers, but has no protection against ingress of liquids. APP® takes a conservative approach in rating our connectors against liquid ingress and consider any meaningful water ingress to have a harmful effect.

Protection Degree	Solids (First Digit)		Liquids (Second Digit)	
	Description	Protected Against	Description	Protected Against
0	Not Protected		Not Protected	
1	> 50 mm	Large body part such as back of hand	Vertically dripping water (no harmful effect)	Duration: 10 minute Water: 1 mm / minute rainfall Pressure: N/A
2	> 12.5 mm	Adult fingers or similarly sized objects	Tilted 15 degrees up dripping water (no harmful effect)	Duration: 10 minute Water: 3 mm / minute rainfall Pressure: N/A
3	> 2.5 mm	Typical screw drivers or large wires	Water spray up to 60 degree angle (no harmful effect)	Duration: 5 minute Water: 0.7 liter / minute Pressure: 80-100 kN/m ²
4	> 1 mm	Small pointy tools and small wires	Water splash from any direction (no harmful effect)	Duration: 5 minute Water: 10 liter / minute Pressure: 80-100 kN/m ²
5	Dust protected	Complete physical protection, no functional interference from dust	Water jet from any direction (no harmful effect)	Duration: 3+ minute Water: 12.5 liter / minute Pressure: 30 kN/m ² @ 3 m distance
6	Dust sealed	Complete physical protection and sealed from dust ingress	Strong water jet from any direction (no harmful effect)	Duration: 3+ minute Water: 100 liter / minute Pressure: 100 kN/m ² @ 3 m distance
7	N/A		No ingress of water in harmful quantity when immersed up to 1 m depth	Duration: 30 minute Water: Immersion Pressure: 1 m depth
8			No ingress of water in harmful quantity when subject to tests in excess of condition 7	Duration: Mfg. specified Water: Immersion Pressure: 1+ m depth. Mfg. specified

| Preventative Maintenance |

Damaged connectors, contacts and cables may present hazards, resulting in inefficient battery and charger operation. To avoid these problems, conduct the following maintenance checks at least once annually. When you see a problem, take corrective action immediately.

1. Dirty Connectors

When engaged and disengaged, the contact surfaces of Anderson SB® Connectors “over wipe,” thus providing a self cleaning action. To ensure the continued benefit of this feature, clean the contact surfaces and lubricate the connector. Use a “white” lithium grease, which may be obtained from hardware stores and automotive parts suppliers.

2. Melting Connectors

Connector housings overheat and melt for many reasons. To prevent this:

- A. Examine the crimp between cable and contact. Ensure the crimp tooling recommended by APP® has been used. Improper crimping, corrosion, and broken wires result in unnecessary resistance causing the contact to heat up.
- B. Check contact surfaces for signs of “pitting” caused by dirt or disengaging connectors under load. One badly pitted contact, particularly in a connector attached to a battery charger, can lead to pitting on surfaces of other contacts. If not corrected, this can result in an epidemic of bad connectors throughout a fleet of electric vehicles and in chargers and batteries.
- C. Check to see if batteries are being disconnected while the charger is still on. This causes the contacts to arc at the tips, resulting with progressive pitting and silver removal from tip to crown. If this practice is occurring, discontinue it now to avoid major repairs in the future.

3. Other Conditions

If any of the following conditions exist, the connector housing, contact and/or cable should be replaced immediately.

- A. **Housing:** Cracks, missing pieces, evidence of excessive heat, discoloration. You may consider replacing the existing housing with a Chemical Resistant equivalent for improved durability against UV rays and common solvents and hydrocarbons.
- B. **Contacts:** Pitting, burns, corrosion, excessive wear, cracked crimp barrels, discoloration.
- C. **Cable:** Exposed copper near housing, cracked cable, peeling or frayed insulation.
- D. **Handles:** Loose attachment and signs of damage as missing or loose hardware and cracked or broken plastic (Handles should be used for connectors that are hard to reach or move.)
- E. **Cable Clamps:** Loose attachments, signs of abraded cable jacket, missing or loose hardware. (Cable clamps should be used to relieve strain on unmounted cable.)



Uncrimped Good Contact

Damaged Contact



B

Glossary of Terminology

Amp / Ampere: Measurement increment of electric current. Abbreviated as "I".

Applicator: A semi-automatic termination machine consisting of an upper and lower half that is used to crimp contacts onto wire. Used in conjunction with an electrical/ mechanical press.

AWG: American Wire Gauge. A standard system for designating wire diameters.

Blindmate: To join two connector halves in a normal engaging mode without visual orientation.

Busbar: Three dimensional constructions enabling electrical distribution of current in power electronic modules. Typically constructed of copper, busbars are most frequently used in power dense applications where the busbar offers a cost or space savings over wire.

Color Coding: A system of identification for terminals and related devices.

Contact Resistance: The electrical resistance of metallic surfaces at their interface in the contact area under specified conditions when carrying a specified test current.

Contact Retention: Minimum axial load in either direction which a contact must withstand while remaining firmly fixed in its normal position within a housing.

Crimp Retention: The axial load which a contact can withstand without separation from the wire.

Crimp Termination: A connection in which a metal sleeve is secured to a conductor by mechanically deforming the sleeve with presses or automated crimping machines, eliminating the need for solder. Not suitable for solid (non-stranded wires).

CSA: Canadian Standards Association, a safety standard writing and testing organization.

Cycle Controlled: To determine if repetitive on/off conditions result in degrading the contact system which may lead to failures such as "thermal run away".

Detent: A bump or raised section projecting from the surface of a contact for keeping the contact in position relative to another and released by greater force.

Dielectric Strength (Withstanding Voltage): The highest potential difference (voltage) that an insulation material of given thickness can withstand for a specified time without occurrence of electrical breakdown through its bulk.

Finger Proof: A connector intended for usage external to the end equipment shall have live parts protected against exposure to contact by persons when assembled, installed, and mated as intended, as determined by UL Articulated probe.

Flammability: The measure of a material's ability to support combustion. Often tested per UL94.

Flat Wiping: The sliding action which occurs when contacts are mated. Wiping has the effect of removing small amounts of contamination from the contact surfaces, thus establishing better conductivity.

Genderless: See "Hermaphroditic"

Heat Rise: Temperature rise associated with the electrical load applied to a mated connection.

Hermaphroditic (Genderless) Connector: A connector in which both mating members are exactly alike at their mating face. There are no male or female members, but designs provide correct polarity.

Hot Plug / Hot Swap: Live connector insertion / extractions.

IEC: International Electrotechnical Commission, a standard writing organization.

Insulation Resistance: Ratio of applied voltage to the total current between the two electrodes in contact with a specific insulation.

IP: Ingress Protection, a standard per IEC 60529 for measurement of ingress for solids and liquids into an enclosure.

Locator / Positioner: Device for positioning contacts into crimping dies.

Make-First / Break-Last (Premate): Sequencing of contact(s) so that they engage prior to the main power contacts. Typically used for ground / positive earth / neutral positions as a protective measure against excess currents, short-circuits, and ground faults.

Make-Last / Break-First (Postmate): Sequencing of contact(s) so that they engage after the main power contacts. Typically used for signal or auxiliary power positions to ensure communications are not started or power circuits switched on until the power contacts are fully engaged.

Mating Force: Force required to join two connector halves in a normal engaging mode.

Modular: Refers to similar parts or modules used as building blocks. A modular connector is one in which similar or identical sections can be assembled together to provide the appropriate connector type or size for the application.

Ohms: Measurement increment of resistance.

Operating Temperature Range: Connector temperature rating established by materials used, plastic, finish, and the base metal. Applying an electrical load will result in a temperature rise that is additive to the operating ambient.

PCB: Acronym for Printed Circuit Board

Polarization: A technique of eliminating symmetry so that parts may only be mated one way.

Pulse (Surge) Current: Highest instantaneous current that will run through a system.

REACH: The European Community Regulation on chemicals and their safe use. It deals with the Registration, Evaluation, Authorization and Restriction of Chemical substances.

Reducing Bushing: Separate tubular sleeve used to downsize the diameter of a crimp barrel to accept a smaller size wire.

Reeled Contacts: Contacts attached to a feeder strip for use in a high volume crimping tool.

Resistance: The opposition to the passage of an electric current through that element. Abbreviated as "R".

RoHS: Restriction of Hazardous Substances Directive. The European directive on the restriction of the use of certain hazardous substances in electrical and electronic equipment.

Sacrificial Tip: An area of a contact system that absorbs electric arcing to limit damage to the actual mating surface of the contacts.

Self-Wiping: The sliding action which occurs when contacts are mated. Wiping has the effect of removing small amounts of contamination from the contact surfaces, establishing better conductivity.

Spring Loaded: A means of providing contact normal force with the use of a mechanical spring.

Storage Battery: A voltaic battery consisting of two or more storage cells. Energy is accumulated by chemical activity in the charging process and released on demand in the form of electric current.

Strain Relief: A means of termination or installation that reduces the transfer of mechanical stress from the conductor.

Termination: Means of joining contacts to a conductor.

Touch Safe: See "Finger Proof"

Turret / Positioner: See "Locator"

TUV: The TÜV Rheinland Group is provider of technical services that certifies products to standards written by other organizations.

UL: Underwriters Laboratory, a safety standard writing and testing organization.

Volts: Measurement increment of electric potential. Abbreviated as "E".

VDE: A German standard writing and testing organization responsible standards and safety specifications covering the areas of electrical engineering, electronics and information technology.

Watt: Measurement increment of electric power. Abbreviated as "W".

Engineering Reference

| Conversion Chart for American Wire Gauge to Metric System |

AWG Size	Metric mm ²	Circ. Mils	Equivalent Circ.Mils	Approximate Wire Diameter	
				in.	mm
-	0.5	-	937	0.032	0.81
20	-	1020	-	0.036	0.91
-	0.75	-	1480	0.039	0.99
18	-	1620	-	0.046	1.16
-	1	-	1974	0.051	1.30
16	-	2580	-	0.051	1.29
-	1.5	-	2960	0.063	1.60
14	-	4110	-	0.073	1.84
-	2.5	-	4934	0.081	2.06
12	-	6530	-	0.092	2.32
-	4	-	7894	0.102	2.59
10	-	10380	-	0.116	2.93
-	6	-	11840	0.126	3.21
8	-	16510	-	0.146	3.70
-	10	-	19740	0.162	4.12
6	-	26240	-	0.184	4.66
-	16	-	31580	0.204	5.18
4	-	41740	-	0.232	5.88
-	25	-	49340	0.260	6.60
2	-	66360	-	0.292	7.42
-	35	-	69070	0.305	7.75
1	-	83690	-	0.332	9.43
-	50	-	98680	0.365	9.27

AWG Size	Metric mm ²	Circ. Mils	Equivalent Circ.Mils	Approximate Wire Diameter	
				in.	mm
1/0	-	106mcm*	-	0.373	9.46
2/0	-	133mcm*	-	0.419	10.60
-	70	-	138.1mcm	0.430	10.90
3/0	-	168mcm*	-	0.471	12.00
-	95	-	187.5mcm	0.504	12.80
4/0	-	212mcm*	-	0.528	13.40
-	120	-	237.8mcm	0.567	14.40
-	-	250mcm	-	0.575	14.60
-	150	300mcm	-	0.630	16.00
-	-	350mcm	-	0.681	17.30
-	185	-	365.1mcm	0.700	17.80
-	-	400mcm	-	0.728	18.50
-	240	-	473.6mcm	0.801	20.30
-	-	500mcm	-	0.814	20.70
-	300	-	592.1mcm	0.891	22.60
-	-	600mcm	-	0.893	22.70
-	-	700mcm	-	0.964	24.50
-	-	750mcm	-	0.999	25.40
-	400	-	789.4mcm	1.026	26.10
-	-	800mcm	-	1.032	26.20
-	500	-	986.8mcm	1.152	29.30
-	-	1000mcm	-	1.153	29.30
-	625	-	1233.7mcm	1.287	32.70

* Rounded for simplicity

NOTE: The above wire diameters and circular mils are based on an average of the most commonly available wires. The wire manufacturer's specification should be referenced for information specific to the wire being used.

| Volts • Amps • Ohms • Watts Conversion |

E (volts)	I (amps)	R (ohms)	W (watts)
\sqrt{WR}	$\frac{E}{R}$	$\frac{E}{I}$	$E I$
$\frac{W}{I}$	$\sqrt{\frac{W}{R}}$	$\frac{W}{I^2}$	$I^2 R$
IR	$\frac{W}{E}$	$\frac{E^2}{W}$	$\frac{E^2}{R}$

Volts = $\sqrt{\text{Watts} \times \text{Ohms}}$

Amperes = $\frac{\text{Volts}}{\text{Ohms}}$

Ohms = $\frac{\text{Volts}}{\text{Amps}}$

Watts = Volts x Amps

Volts = $\frac{\text{Watts}}{\text{Amps}}$

Amperes = $\sqrt{\frac{\text{Watts}}{\text{Ohms}}}$

Ohms = $\frac{\text{Watts}}{\text{Amps}^2}$

Watts = Amps² x Ohms

Volts = Amps x Ohms

Amperes = $\frac{\text{Watts}}{\text{Volts}}$

Ohms = $\frac{\text{Volts}^2}{\text{Watts}}$

Watts = $\frac{\text{Volts}^2}{\text{Ohms}}$

Wattage Varies Directly as a Ratio of Voltages Squared.

$$W^2 = W^1 \left(\frac{E^2}{E^1} \right) \times^2$$

3 Phase Amperes = $\frac{\text{Total Watts}}{\text{Volts} \times 1.732}$

| Standard to Metric Conversions |

Approximate Conversions From: Standard / US Customary To: SI / Metric Units				
Symbol	When You Know	Multiply By	To Find	Symbol
LENGTH				
in	inches	25.4	millimeters	mm
ft	feet	0.305	meters	m
AREA				
in ²	square inches	645.2	square millimeters	mm ²
ft ²	square feet	0.093	square meters	m ²
VOLUME				
fl oz	fluid ounces	29.57	milliliters	mL
gal	gallons	3.785	liters	L
ft ³	cubic feet	0.028	cubic meters	m ³
MASS				
oz	ounces	28.35	grams	g
lb	pounds	0.454	kilograms	kg
TEMPERATURE				
°F	Fahrenheit	(F-32) x 5 / 9 or (F-32) / 1.8	Celsius	°C
FORCE and PRESSURE or STRESS				
lbf	poundforce	4.45	newtons	N
lbf/in ²	poundforce per square inch	6.89	kilopascals	kPa

Approximate Conversions From: SI / Metric Units To: Standard / US Customary				
Symbol	When You Know	Multiply By	To Find	Symbol
LENGTH				
mm	millimeters	0.039	inches	in
m	meters	3.28	feet	ft
AREA				
mm ²	millimeters	0.0016	square inches	in ²
m ²	square meters	10.764	square feet	ft ²
VOLUME				
mL	milliliters	0.034	fluid ounces	fl oz
L	liters	0.264	gallons	gal
m ³	cubic meters	35.314	cubic feet	ft ³
MASS				
g	grams	0.035	ounces	oz
kg	kilograms	2.202	pounds	lb
TEMPERATURE				
°C	Celsius	1.8C + 32	Fahrenheit	°F
FORCE and PRESSURE or STRESS				
N	newtons	0.225	poundforce	lbf
kPa	kilopascals	0.145	poundforce per square inch	lbf/in ²

| Scratch Pad |

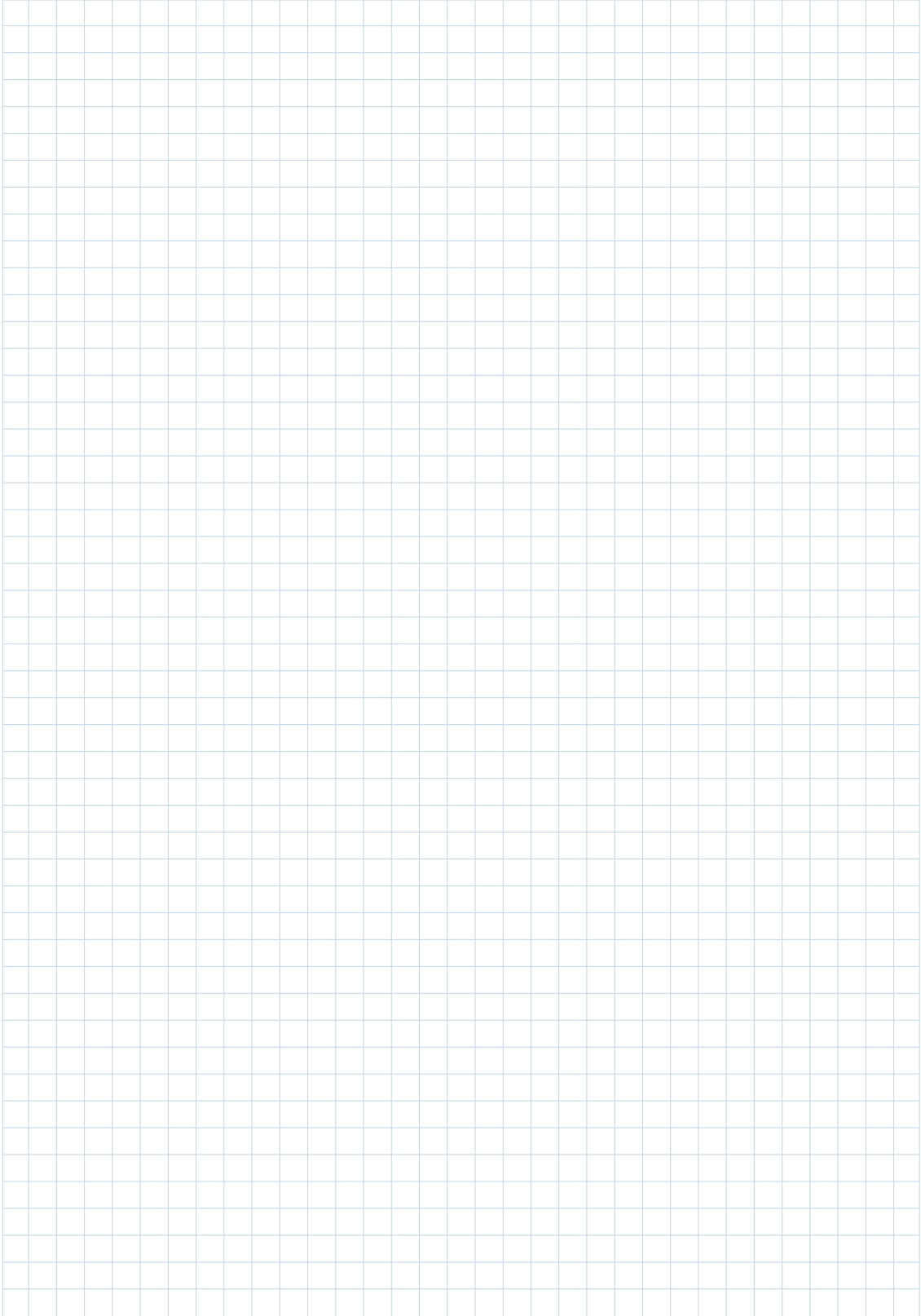

Powerpole® Family

Powerpole® Connectors - PP15 to PP180

SECTION 2
Powerpole® Family

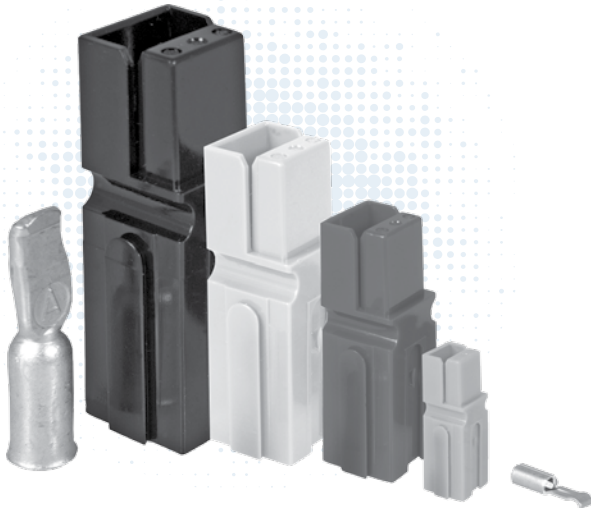

This versatile connector series invented by Anderson Power Products® meets a wide range of power connection needs. There are four basic housing sizes in the Powerpole® product family that allow specific amperage or wire size needs to be filled in the most compact footprint. Powerpole® can handle up to 350 amperes per pole and accommodate wire ranges of #20 AWG (0.5 mm²) to 3/0 (70 mm²). A wide range of colored housing options can be stacked together to create a proven reliable custom connector. These housings can be used with different contacts to create wire-to-wire, wire-to-board, or wire-to-busbar connections. The Powerpole® combines high quality materials and a cost effective innovative design to allow powerful versatility.

Stackable Modular Housings

Available in four sizes to right size your connection need

Color Coded Housings

Help ensure that connectors are assembled and mated correctly

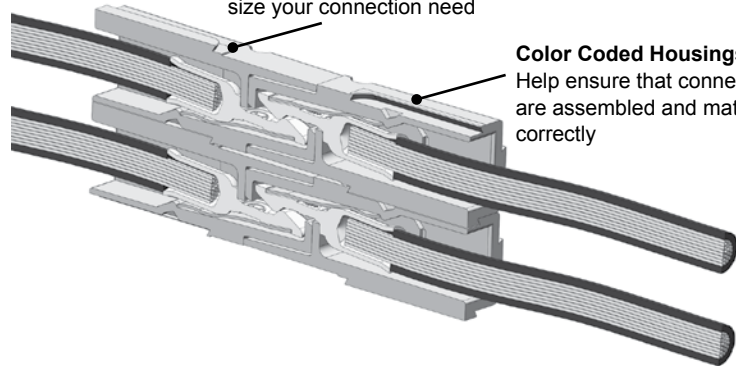

Genderless Housings

Provide simplified assembly and minimize the number of components

Low Resistance Connection

Silver or tin plated contacts inside housings that strongly force the contacts together

Self Securing Design

Stainless steel springs create a robust force between the contacts that holds the connector in the mated condition, but allows it to be quickly disconnected

Hot Plugging AC or DC

Contacts feature a sacrificial tip that allow high current circuit interrupt

Connection Versatility

Contacts for wire, PCB, or busbar all fit into the same housings

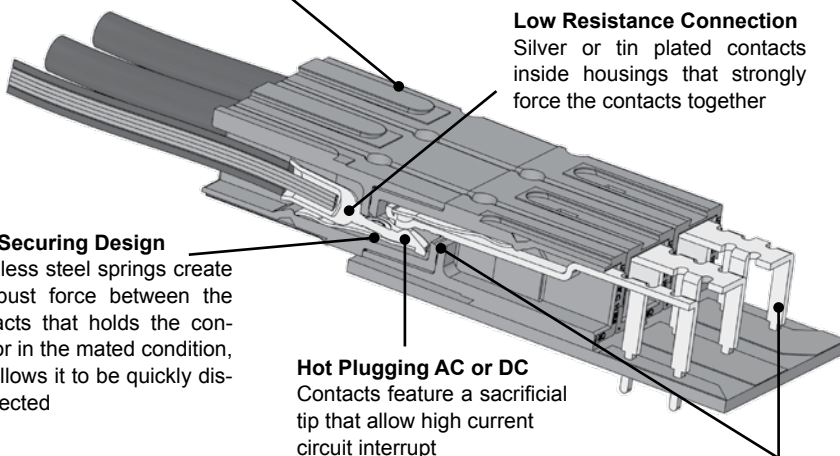

| POWERPOLE FAMILY SELECTION GUIDE |

Powerpole® Size	PP15 to 45	Page #	PP75	Page #	PP120	Page #	PP180	Page #
Connector Types	Standard	20	Standard	30	Standard	36	Standard	39
	Finger Proof	20	Locking	31			Busbar	40
	PCB	21	Busbar	31				
	Ground	21	PCB	31				
	Power Pak	23						
Amps (UL) Per Pole	0 to 55		120		240		350	
Volts (UL) Per Pole	600		600		600		600	
Wire Gauge (AWG)	20 - 10		16 - 6		6 - 1/0		10 - 3/0	
Wire Gauge (mm²)	0.05 - 6.0		1.3 - 13.3		13.3 - 53.5		5.3 - 85.0	
Number of Power Circuits	1 / Stackable		1 / Stackable		1 / Stackable		1 / Stackable	
Ground	•							
PCB Mount	•		•					
Busbar			•				•	
Panel Mount	•		•		•		•	
Blind Mate	Powerpole® Pak							
Hot Plug	•		•		•		•	
Touch Safe	•							
Polarized Housing	•		•		•		•	
Latching	Powerpole® Pak							
Strain Relief	Powerpole® Pak							

SECTION 2
Powerpole® Family

Actual Size - Connector Half

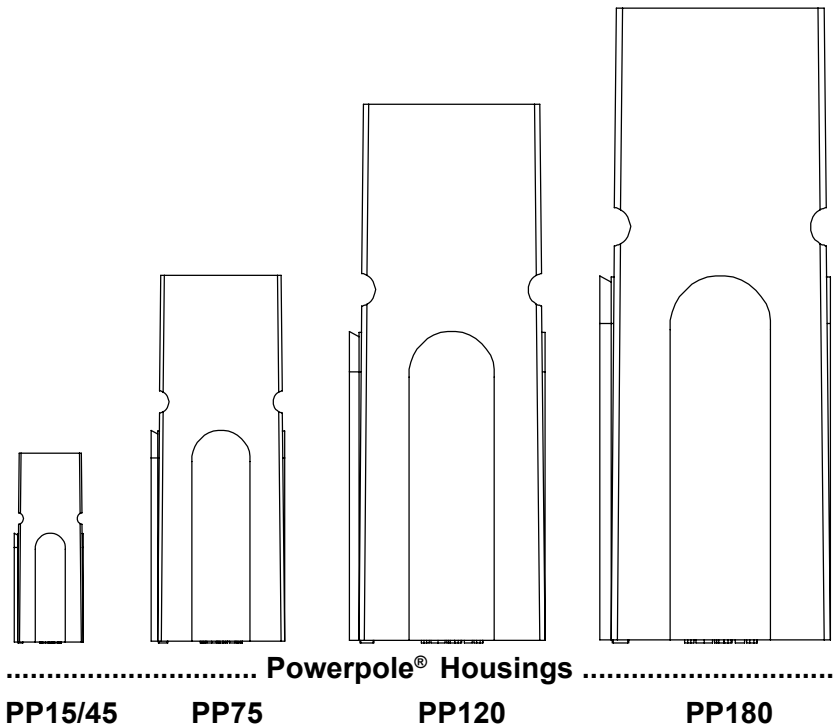

Powerful Versatility

- Create Your Own Custom Connector from Durable Proven Components

Powerpole® connectors can be easily customized to each power connection need. Choose from a wide range of colored housings and stack them together into a multiple position connection. Durable silver or tin plated contacts crimp and poke into housings and are available for a broad range of wire sizes. PCB and busbar contacts can also be simply snapped into place using the same housings. Pre-mate ground / power housings and contacts can be used for safety or sequencing and stack along with standard housings.

How to Create Mating Blocks of Stacked Powerpole® Connectors

A Single Row Assembly such as the 1x3 shown below will mate to itself. If an assembly has more than one row such as the Two Row Assembly 2x1 shown below, then a different mirror image mating assembly is required.

Single Row Assembly 1x3

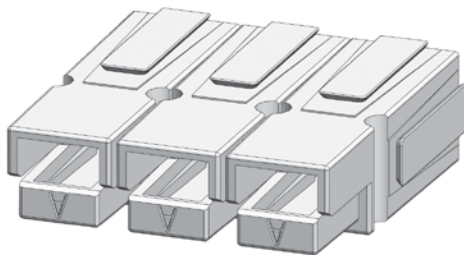

Two Row Assembly 2x1

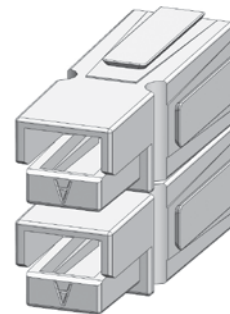

To Create a Mirror Image Mating Assembly:

When mating blocks are viewed with their hoods in the respective orientation (down or up), the column position of connectors is unchanged. The rows themselves are mirror images of each other. So in the below example, what is column 1 on side A, is column 3 on side B.

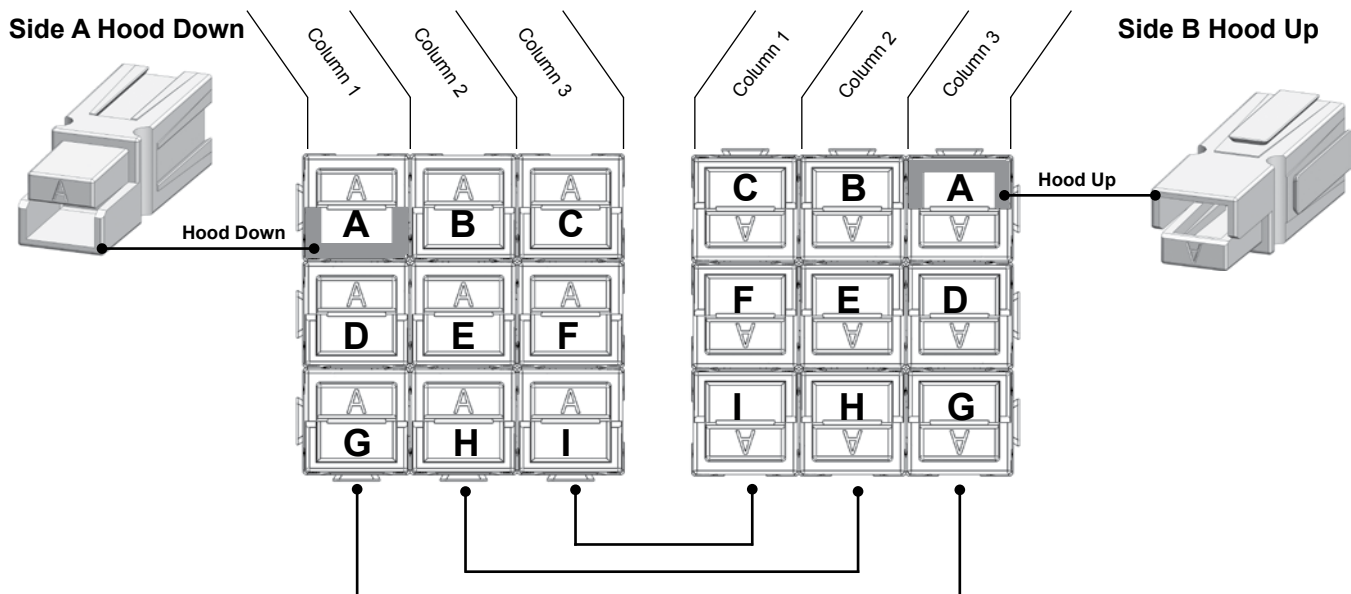

Use the Same Housings for Wire, PCB, or Busbar Connections

The Powerpole® connection system allows the same housings to hold different contacts for terminating to wire, printed circuit boards, or busbars. See some of the many ways Powerpole® components can be assembled to create a custom connection solution.

Wire-to-Wire

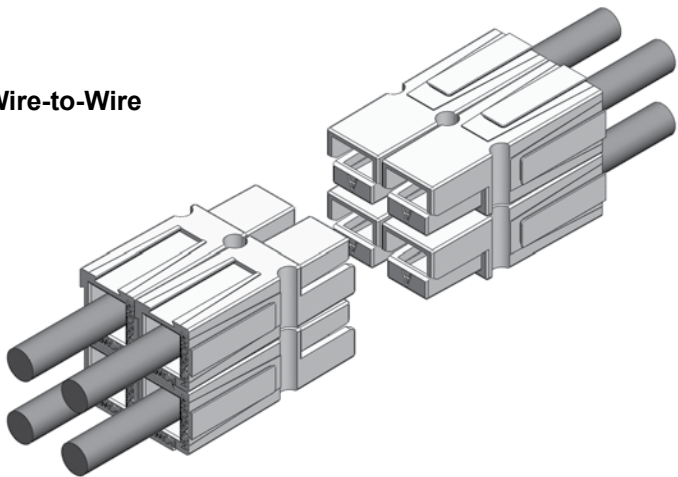

Wire-to-PCB

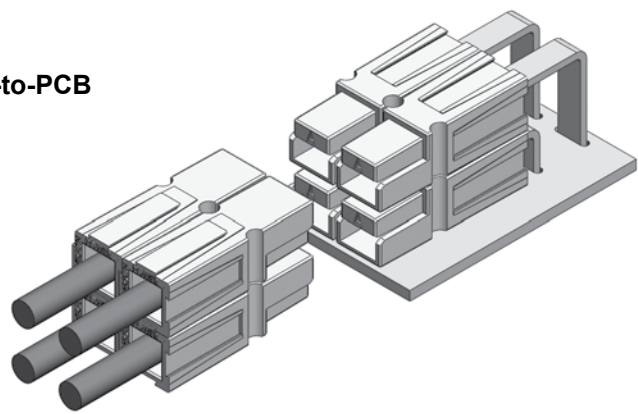

Wire-to-Busbar

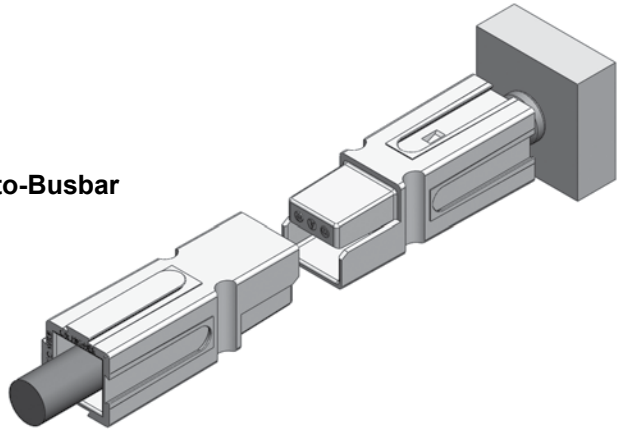

Powerpole® Connectors

- PP15 to PP45 : up to 55 Amps

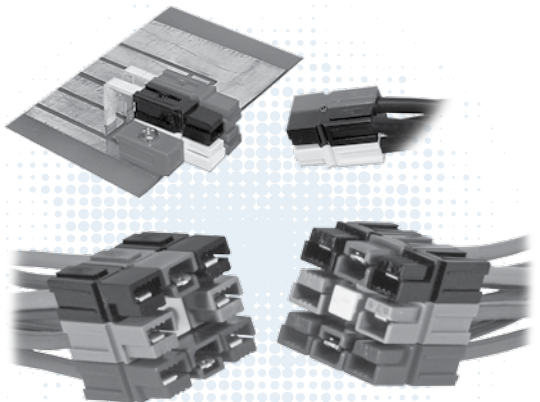

PP15-45 series are the smallest Powerpole® housings. They can be used for wire-to-wire or wire-to-board applications. Wire sizes from #20 AWG (0.5 mm²) to #10 (6 mm²) offer power capabilities up to 55 amps per pole. Finger proof housings and the ability to incorporate first-mate last-break ground connectors enhance the capabilities of this Powerpole® series.

High Power Density

- Up to 55 amps in a compact footprint

Wire-to Wire & Wire-to-Board Configurations

- Wire & PCB contacts can be used in the same housings

Finger Proof Housings Available

- Protects against accidental contact with live circuits

| PP15-45 ORDERING INFORMATION |

PP15-45 Finger Proof Housings

Improved on the original APP® design by adding ribs to mating interface to protect against accidental contact with live circuits. Meets the requirements of UL1977 section 10.2 and is rated IP20. Will not mate with standard housings.

Description	Part Numbers	
Minimum Quantity ...	2,500	200
Red	1327FP-BK	1327FP
Green	1327G5FP-BK	1327G5FP
Black	1327G6FP-BK	1327G6FP
White	1327G7FP-BK	1327G7FP
Blue	1327G8FP-BK	1327G8FP
Yellow	1327G16FP-BK	1327G16FP

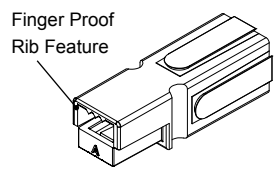

PP15-45 Finger Proof & Standard & Ground Housing Dimensions

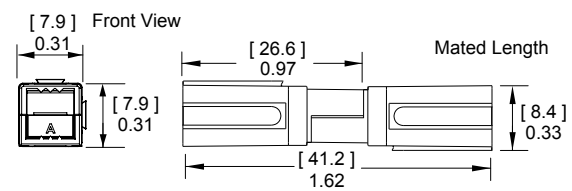

PP15-45 Standard Housings

The original housing design has an open interface and is available in a wide array of colors. Will not mate with finger proof housings.

Description	Part Numbers	
Minimum Quantity ...	2,500	200
Red	1327-BK	1327
Green	1327G5-BK	1327G5
Black	1327G6-BK	1327G6
White	1327G7-BK	1327G7
Blue	1327G8-BK	1327G8
Yellow	1327G16-BK	1327G16
Orange	1327G17-BK	1327G17
Gray	1327G18-BK	1327G18
Brown	1327G21-BK	1327G21
Pink	1327G22-BK	1327G22
Purple	1327G23-BK	1327G23

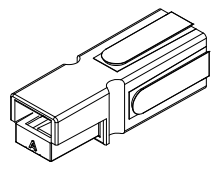

45A Premate Ground Housings

Green housings are keyed to prevent accidental mating with standard or finger proof Powerpole® housings.

Description	Part Number	
Minimum Quantity ...	2,500	200
Green	1827G1-BK	1827G1

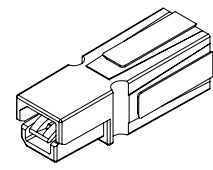

PP15-45 Tin Plated Power Contacts

Offer cost effective performance up to 1,500 mating cycles. See specifications and temperature charts for amperage ratings by wire size.

Barrel	AWG	mm ²	Mating Force	Loose Piece Part Numbers	Reeled Part Numbers	Dimensions - A -	
						inches	mm
Minimum Quantity				200	5,000		
Open	14 to 10 K*	2.1 to 5.3	High	269G3-LPBK	269G3	0.21	5.33
Open	14 to 10 K*	2.1 to 5.3	Low	261G2-LPBK	261G2	0.20	5.08
Open	14 to 10 SF*	2.1 to 6.0	High	201G1H-LPBK	201G1H	0.24	6.10
Open	14 to 10 SF*	2.1 to 6.0	Low	200G1L-LPBK	200G1L	0.24	6.10
Open	16 to 12	1.3 to 3.3	High	269G1-LPBK	269G1	0.18	4.57
Open	16 to 12	1.3 to 3.3	Low	261G1-LPBK	261G1	0.18	4.57
Open	20 to 16	0.52 to 1.3	High	269G2-LPBK	269G2	0.16	4.06
Open	20 to 16	0.52 to 1.3	Low	262G1-LPBK	262G1	0.16	4.06
Open	20 to 16 SF*	0.52 to 1.5	Low	200G2L-LPBK	200G2L	0.20	5.08

K* - For #10 AWG class K stranded wire or smaller. For larger wires use superflex contacts.
SF*- Indicates wires with high stranding such as Super Flex.

Open Barrel Contact

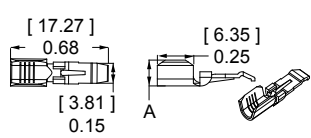

PP15-45 Silver Plated Power Contacts

Maximize performance by offering up to 10,000 mating cycles and are recommended for circuit interrupt or hot plug applications. See specifications and temperature charts for amperage ratings by wire size. Only closed barrel contacts are suitable for soldering.

Barrel	AWG	mm ²	Mating Force	Loose Piece		Reeled Part Number	Dimensions						
				Part Number			- A -		- B -				
Minimum Quantity				5,000	200	5,000							
Open	14 to 10 K*	2.1 to 5.3	Low	-	261G3-LPBK	261G3	0.20	5.08	-	-			
Open	14 to 10 SF*	2.1 to 6.0	High	-	-	201G3H	0.24	6.10	-	-			
Open	14 to 10 SF*	2.1 to 6.0	Low	-	200G3L-LPBK	200G3L	0.24	6.10	-	-			
Open	16 to 12	1.3 to 3.3	Low	-	261G4-LPBK	261G4	0.18	4.57	-	-			
Open	20 to 16	0.52 to 1.3	Low	-	262G2-LPBK	262G2	0.16	4.06	-	-			
Open	20 to 16 SF*	0.52 to 1.5	Low	-	-	200G4L	0.20	5.08	-	-			
Closed	16 to 12	1.3 to 3.3	Low	1331-BK	1331	-	0.15	3.81	0.10	2.54			
Closed	20 to 16	0.52 to 1.3	Low	1332-BK	1332	-	0.12	3.05	0.07	1.78			

K* - For #10 AWG class K stranded wire or smaller. For larger wires use superflex contacts.
SF* - Indicates wires with high stranding such as Super Flex.

Open Barrel Contact

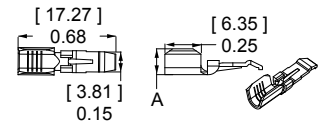

Closed Barrel Contact

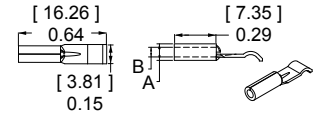

45A Premate Ground Wire Contacts

Tin or silver plated contacts are rated for ground or power. Hand tools are available for loose piece contacts. Reeled contacts can be used with high volume press and applicator tooling. Tin contacts are rated for up to 1,500 mating cycles. Silver contacts are rated up to 10,000 mating cycles.

Type	AWG	mm ²	Mating Force	Loose Piece - Part Numbers -	Reeled Part Numbers -
Minimum Quantity				200	5,000
Open, Tin	14 to 10	2.1 to 6.0	Low	1830G1-LPBK	1830G1
Open, Silver	14 to 10	2.1 to 6.0	Low	1830G2-LPBK	1830G2

Open Barrel Premate Contact

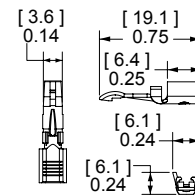

25A Right Angle PCB Contacts Tin Plated

Suitable for right angle applications up to 25A per pole. Tin plating enhances solderability. Cannot be mixed with 45A PCB contacts. For mating with wire contacts only.

Row	Mating Force	Loose Piece		Dimensions			
		Part Numbers		- A -		- B -	
Minimum Quantity		1,000	100				
Top	Low	1377G1-BK	1377G1	0.59	14.80	1.52	38.60
	High	1317G1-BK	1317G1				
Bottom	Low	1377G2-BK	1377G2	0.29	7.20	1.36	34.50
	High	1317G2-BK	1317G2				
Top	Low	1377G11-BK	1377G11	0.59	14.80	1.21	30.70
	High	1317G11-BK	1317G11				
Bottom	Low	1377G12-BK	1377G12	0.29	7.20	1.01	25.70
	High	1317G12-BK	1317G12				

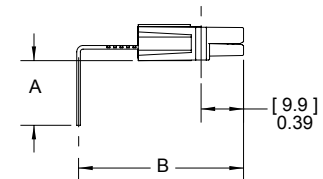
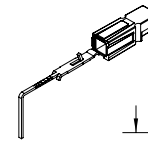

Use mounting staples with right angle contacts (see accessories).

See website for PCB layout drawing.

25A Vertical PCB Contacts Tin Plated

For mating with wire contacts only. Suitable for vertical applications up to 25A per pole, tin plating enhances solderability.

Mating Force	Loose Piece		Dimensions - A -	
	Part Numbers		inches	mm
Minimum Quantity	1,000	100		
Low	1377G3-BK	1377G3	2.22	56.40
High	1317G3-BK	1317G3	2.22	56.40
Low	1377G4-BK	1377G4	1.76	44.70
High	1317G4-BK	1317G4	1.76	44.70
Low	1377G13-BK	1377G13	1.17	29.70
High	1317G13-BK	1317G13	1.17	29.70

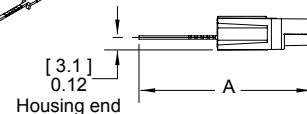
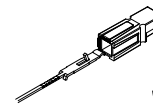

45A Right Angle and Vertical PCB Contacts Tin Plated

Suitable for right angle or vertical applications up to 45A per pole. Tin plating enhances solderability. Right angle contacts cannot be mixed with 25A PCB contacts. For mating with wire contacts only.

Description	Loose Piece	
	Part Numbers	
Minimum Quantity	1,000	100
Vertical	3-5911P1	1335G1
Right Angle Bottom Row	3-5912P1	1336G1
Right Angle Top Row	3-5913P1	1337G1

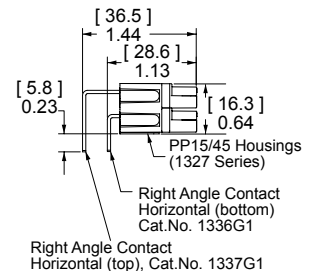
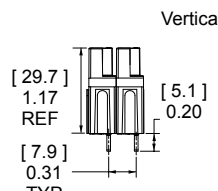

Use mounting staples with right angle contacts (see accessories).

45A Premate Ground PCB Contacts

Right angle contacts are suitable for power or ground. Use to mate with 45A ground wire contacts. Tin plated contacts are rated up to 1,500 mating cycles. Can be used with other 45A PCB connectors in the bottom row.

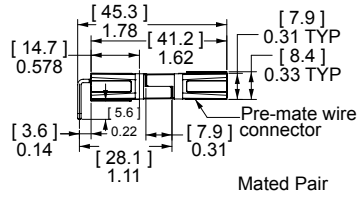

	Mating Force	Loose Piece	
		Part Numbers -----	
Minimum Quantity		1000	100
PCB, Bottom Row	Low	3-5952P1	1836G1

| PP15-45 ULTRASONICALLY BONDED ASSEMBLIES |

Assemblies feature housings that are ultrasonically welded to create a one piece connector unit using an APP® special process. After welding, retaining pins are no longer required to secure the stacked housings to each other. This allows Powerpole® 15-45 connectors to be used as a durable one piece connector header. Contact customer service for configurations not shown below.

Single Row 1x2 Assemblies

Circuit Description	Housings Only	Housings with 45A Vertical PCB Contacts	Housings with 45A Right Angle PCB Contacts	Color & Type Position Matrix	
Minimum Quantity	500	500	500	1	2
DC 2 Wire Standard Housings	ASMPP30-1X2-RK	ASMPV45-1X2-RK	ASMPR45-1X2-RK	RED / STD	BLK / STD
DC 2 Wire Reverse Standard Housings	ASMPP30-1X2-KR	ASMPV45-1X2-KR	ASMPR45-1X2-KR	BLK / STD	RED / STD
DC 2 Wire Finger Proof	ASMFP30-1X2-RK	ASMPV45-1X2-RK	ASMPR45-1X2-RK	RED / FP	BLK / FP
DC 2 Wire Finger Proof Reverse	ASMFP30-1X2-KR	ASMPV45-1X2-KR	ASMPR45-1X2-KR	BLK / FP	RED / FP

Single Row 1x3 Assemblies

Circuit Description	Housings Only	Housings with 45A Vertical PCB Contacts	Housings with 45A Right Angle PCB Contacts	Color & Type Position Matrix		
Minimum Quantity	500	500	500	1	2	3
DC 2 Wire Finger Proof with Ground	ASMFP30-1X3-KER	N/A	ASMPR45-1X3-KER	BLK / FP	GRN / GND	RED / FP
AC Single Phase Finger Proof	ASMFP30-1X3-KEW	ASMPV45-1X3-KEW	ASMPR45-1X3-KEW	BLK / FP	GRN / GND	WHT / FP

Two Row 2x1 Assemblies

Circuit Description	Housings Only	Housings with 45A Vertical PCB Contacts	Housings with 45A Right Angle PCB Contacts	Color & Type Position Matrix	
Minimum Quantity	500	500	500	1	2
DC 2 Wire Finger Proof	ASMFP30-2X1-KR	ASMPV45-2X1-KR	ASMPR45-2X1-KR	BLK / FP	RED / FP
DC 2 Wire Finger Proof Mate	ASMFP30-2X1-RK	ASMPV45-2X1-RK	ASMPR45-2X1-RK	RED / FP	BLK / FP

Two Row 2x2 Assemblies

Circuit Description	Housings Only	Housings with 45A Vertical PCB Contacts	Housings with 45A Right Angle PCB Contacts	Color & Type Position Matrix			
Minimum Quantity	500	500	500	1	2	3	4
AC 3 Phase, 3 Wire Finger Proof	ASMFP30-2X2-KRWE	N/A	N/A	BLK / FP	RED / FP	WHT / FP	GRN / GND
AC 3 Phase, 3 Wire Finger Proof Mate	ASMFP30-2X2-WEKR	ASMPV45-2X2-WEKR	ASMPR45-2X2-WEKR	WHT / FP	GRN / GND	BLK / FP	RED / FP



Single Row 1x2 Assembly



Single Row 1x3 Assembly

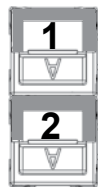

Two Row 2x1 Assembly

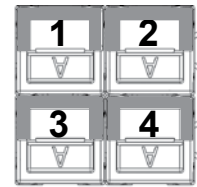

Two Row 2x2 Assembly

Type

STD = Standard Housing
FP = Finger Proof Housing
GND = Ground Housing

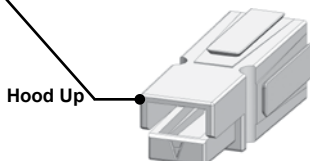

Powerpole® Pak Connectors - PP15 to PP45

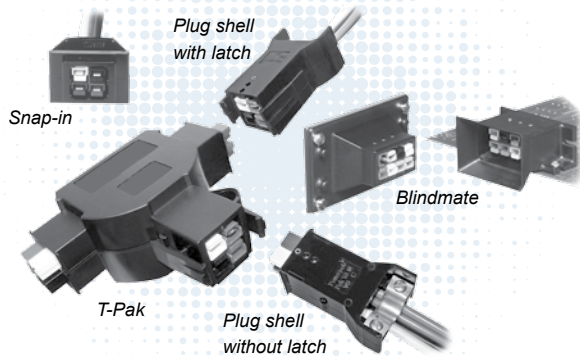

Powerpole® Pak connector shells enclose stacked groupings of PP15-45 sized housings in a durable black shell for a finished connector appearance and additional features. Inline, panel mount, and blindmate configurations are available. Plug shells offer the option of integral latches and strain relief to help secure your connection.

- **Package Groupings of PP15-45 Connectors**
Provides a finished appearance while protecting the individual connectors with an outer shell
- **Inline, Panel Mount, “T” or Blindmate Configurations**
Allows one connection system to meet multiple needs
- **Optional Latching and Strain Relief**
Secures your connection and wires

For environmentally sealed connector shells to hold Powerpole® 15-180 connectors, see APP®’s SPEC Pak® product series on our website, www.andersonpower.com



Powerpole® Pak ORDERING INFORMATION

Powerpole® housings and contacts are sold separately. See page 20 for ordering information.

Plug Shell without Latch

Can mate inline with other plug shells with or without latches, or mate to a panel mount receptacle. For use with Powerpole® wire connectors only. Cable Clamp and Hardware Pak or Retaining Pins must be ordered separately.

Description	Part Numbers			Dimensions - A -	
	1,000	500	25	inches	mm
Minimum Quantity ...	1,000	500	25		
Black, 2-4 Poles	1461G1-BK	-	1461G1	1.24	31.50
Black, 5-6 Poles	-	1461G2-BK	1461G2	1.56	39.62
Black, 7-8 Poles	-	1461G3-BK	1461G3	1.87	47.50

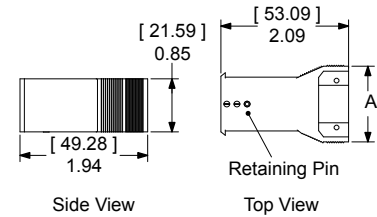

NOTE: Retaining pins are used to secure and position Powerpoles® in one of three positions in plug shells.

Max wire O.D. for 2-4 pole plug shells is 0.60 inches [15.2mm²].
For all other plug shells is 0.63 inches [16.0 mm²].

Plug Shell with Latch

Can mate inline with other plug shells without latches, or mate to a panel mount receptacle. For use with Powerpole® wire connectors only. Cable Clamp and Hardware Pak or Retaining Pins must be ordered separately.

Description	Part Numbers			Dimensions					
	1,000	500	25	- B -		- C -		- D -	
				inches	mm	inches	mm	inches	mm
Minimum Quantity ...	1,000	500	25						
Black, 2-4 Poles	1460G1-BK	-	1460G1	1.94	49.28	2.25	57.15	1.24	31.50
Black, 5-6 Poles	-	1460G2-BK	1460G2	1.94	49.28	2.25	57.15	1.56	39.62
Black, 7-8 Poles	-	1460G3-BK	1460G3	1.94	49.28	2.25	57.15	1.87	47.50
Black, 9-10 Poles	-	1460G4-BK	1460G4	2.51	63.75	2.82	71.63	1.84	46.74

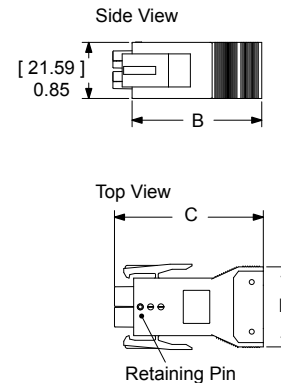

Snap-in Receptacle Shell

Mate to plug shells without latches, or mate to another panel mount receptacle to create a bulkhead to bulkhead connection. For use with Powerpole® wire or PCB connectors. Order the number of retaining pins for each receptacle as shown below separately.

Description	Part Numbers			Number of Retaining Pins to Order	Dimensions - E -		Knock Out Size - Width -	
	1,000	500	25		inches	mm	inches	mm
Black, 2-4 Poles	1470G1-BK	-	1470G1	1	1.50	38.10	1.25	31.75
Black, 5-6 Poles	-	1470G2-BK	1470G2	2	1.88	47.75	1.62	41.15
Black, 7-8 Poles	-	1470G3-BK	1470G3	3	2.13	54.10	1.88	47.75
Black, 9-10 Poles	-	1470G4-BK	1470G4	4	2.44	61.98	2.19	55.63

* Height = [25.4 mm] 1.0 in.

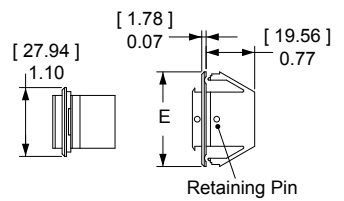

NOTE: Retaining pins are used to secure and position Powerpoles® in one of two positions in receptacle shells.

Cable Clamp & Hardware Pak

Includes cable clamp, 2 screws, and required amount of retaining pins for each configuration.

Description	Screw Head Type	Cable Type	Part Numbers		
			1,000	500	25 ...
2-4 Poles	Straight Slot	Bundled	115G1-BK	-	115G1
5-6 Poles	Straight Slot	Bundled	115G2-BK	-	115G2
7-8 Poles	Straight Slot	Bundled	115G3-BK	-	115G3
9-10 Poles	Straight Slot	Bundled	-	115G4-BK	115G4
2-4 Poles	Phillips	Bundled	115G7-BK	-	115G7
5-6 Poles	Phillips	Bundled	115G8-BK	-	115G8

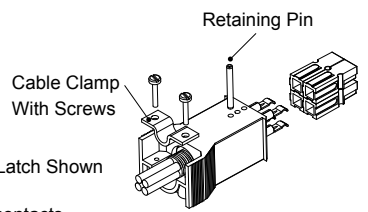

Plug Shell Without Latch Shown

Shell, housing and contacts are sold separately.

Flexible Conduit Clamp & Hardware Pak

Includes cable clamp, 2 screws, and need amount of retaining pins for each configuration.

Description	Part Number
Minimum Quantity 100
2-4 Poles	110G10

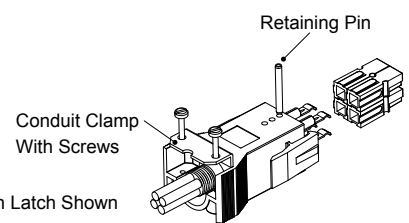

Plug Shell With Latch Shown

Shell, housing and contacts are sold separately.

Retaining Pin for Snap-in Receptacle

Order the number of retaining pins for each receptacle shown in the Snap-in Receptacle Shell ordering information. Pins are also required for the plug side when the Cable Clamp & Hardware Pak is not ordered.

Description	Part Number
Minimum Quantity 1,000 100
Retaining Pin	110G9-BK 110G9

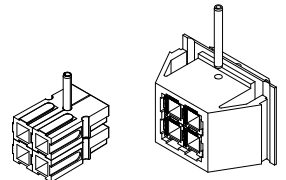

Shell and housing are sold separately.

Blindmate Pak Connector

Ideal for panel to panel, bulkhead to bulkhead, or rack mount applications that require the power connector to compensate for up to 0.45 in. [11.43 mm] of misalignment in either axis. Eight positions can be filled with Powerpole® 10-45 connectors. The receptacle side can be used with wire or PCB contacts. Hardware bag includes retaining pins.

Description	----- Part Numbers -----	
Minimum Quantity	50	25
2x4 Blindmate Plug Shell, Hardware & Pins	-	BMPP10-45P
2x4 Blindmate Receptacle Shell, Hardware & Pins	-	BMPP10-45R
2x4 Blindmate Plug Shell	BMHSG-P	-
2x4 Blindmate Receptacle Shell	BMHSG-R	-
Hardware Bag Plug Side	-	110G50
Hardware Bag Receptacle Side	-	110G51

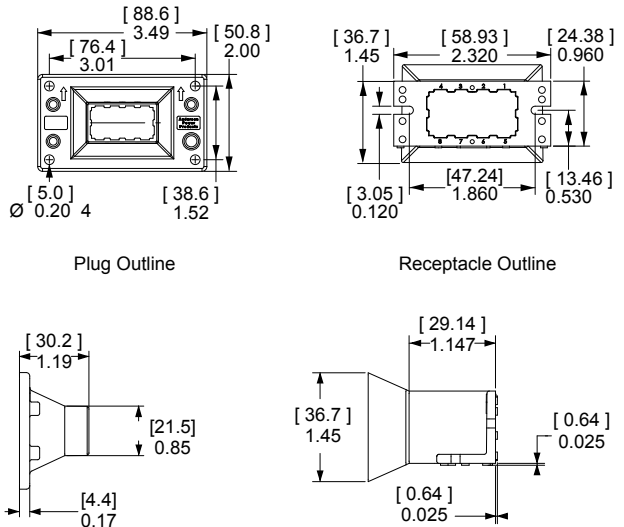

See APP's innovative MARC Connector that offers straight-on or rotational blindmate capability. MARC holds 6 PP15/45 power contacts and 2 PP15/45 premate ground contacts in a high temperature housing. Visit our website, www.andersonpower.com to learn more.



"T" Pak 2 Way Splitter

The Powerpole® "T" Pak connector is a 2 way electrical splitter that splits electrical current from one incoming circuit into two outgoing circuits. The standard configuration is pre-wired for AC 3 phase, 3 wire plus ground configurations. The "T" Pak can also be used for AC single phase plus ground or DC 2 wire plus ground applications by not using either the red or white power positions. "T" Pak is pre-wired from the factory allowing plug and play field installation of modular office and industrial equipment. UL recognition up to 20 amps and 600 volts is achieved when mating Powerpole® Pak plugs are used with #12 AWG wire.

For OEM manufacturing scale applications, the "T" Pak can be loaded with custom configurations of any of APP's finger proof, standard, or ground housings and contacts in the PP15-45 series. Contact APP's sales or customer service for additional information.

Description	- Part Numbers -
Minimum Quantity	80
Assembled "T" Pak	20-01
Mating Plug Shell with Latch 2x2	26-01
Mating Plug Shell without Latch 2x2	27-01

Standard configuration for each side of the T includes (1) each Red, Black, and White Standard PP 15-45 Housings & 261G2-LPBK contacts with (1) 45A Green Premate Ground Housing and 1830G1-LPBK contact.

Mating plug shells include (1) each Red, Black, and White Standard PP 15-45 Housings & (3) 261G2-LPBK contacts with (1) 45A Green Premate Ground Housing and 1830G1-LPBK contact. Cable clamp & hardware pak also included.

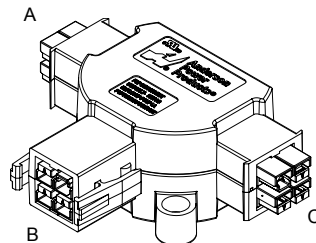
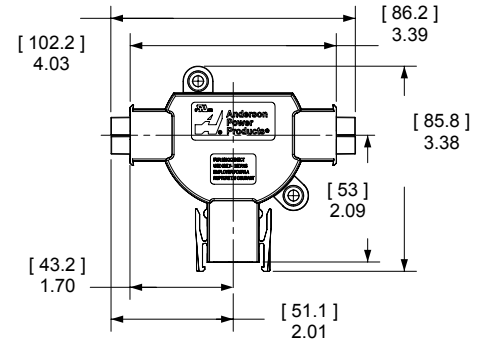

PP15-45 & POWERPOLE® PAK SPECIFICATIONS |

SECTION 2
Powerpole® PP15 to 45

Electrical		
Current Rating Amperes¹	UL 1977	CSA/TUV
Singlepole Wire to Wire (10 AWG)	55	40
Singlepole Ground Wire to Wire or PCB (10 AWG)	45	35
3x3 Block Wire to Wire (10 AWG)	40	27
Singlepole 25A PCB to Wire (12 AWG)	25	-
2x3 Block 25A PCB to Wire (12 AWG)	25	22 *
Singlepole 45A PCB to Wire (10 AWG)	45	40 *
2x3 Block 45A PCB to Wire (10 AWG)	45	25 *
Voltage Rating AC/DC		
UL 1977	600	
PCB Connector Recommended Voltage³ per IEC 60950-1 Table 2L Pollution Degree²		
25A Contacts Adjacent Poles	495	
25A Contacts Separated by Spacer	1,000	
45A Contacts Adjacent Poles	160	
45A Contacts Separated by Spacer	970	
Dielectric Withstanding Voltage		
Volts AC	2,200	
Avg. Mated Contact Resistance Milliohms¹		
15A Wire Contact with 5/8" of #16 AWG	0.875	
30A Wire Contact with 5/8" of #12 AWG	0.600	
45A Wire Contact with 5/8" of #10 AWG	0.525	
45A PCB Contact to Contact	0.500	
25A PCB Contact to Contact	0.600	
UL Hot Plug Current Rating Amperes		
250 cycles at 72V DC	45A	
250 cycles at 120V DC	30A	
UL Ground Short Time Current Test - 45A Premate Ground		
750 Amps, #10 AWG Wire	4 Seconds	
470 Amps, #12 AWG Wire	4 Seconds	

Materials	
Housing	
Plastic Resin	Polycarbonate
Contact Retention Spring	Stainless Steel
Housing Flammability Rating	
UL94	V-0
Contact	
Base	Copper Alloy
Plating	Tin or Silver
Contact Termination Methods	
Crimp ³	Wire Contacts
Hand Solder	Wire and PCB Contacts
Solder Dip	PCB Contacts
Wave Solder	PCB Contacts

Mechanical		
Wire Size Range	AWG	mm²
	20 to 10	0.5 to 6.0
Max. Wire Insulation Diameter	in.	mm
	0.175	4.450
Operating Temperature²	°F	°C
Powerpole® Housings & Powerpole® Pak Shells	-4° to 221°	-20° to 105°
Mating Cycles No Load by Plating	Silver (Ag)	Tin (Sn)
PCB to Wire	-	1,500
Wire to Wire	10,000	1,500
Avg. Mating / Unmating Force	Lbf.	N
Low Force Wire, High Force PCB, & Ground	3	13
High Force Wire	5	22
Low Force PCB	2	9
Min. Contact / Spring Retention Force	Lbf.	N
	20	90
Powerpole® Pak Latch Avg. Defeat Force	Lbf.	N
	150	667
PCB Specifications		
Mounting Style	Plated Through Hole	
PCB Thickness- in. [mm]	0.090 - 0.150	(2.3-3.8)
25A PCB Recommended Traces	#12 AWG Cross Section	
45A PCB Recommended Traces	#10 AWG Cross Section	
Min. Creepage / Clearance Distance PCB	in.	mm
25A Creepage & Clearance Adjacent Poles	0.201	5.1
45A Creepage & Clearance Adjacent Poles	0.067	1.7

Protection	
Touch Safety with Finger Proof Housings & Wire Contacts or PCB Mating Interface	
UL1977 Sec. 10.2	Pass
IEC 60950	Pass
IEC 60529	IP20
Touch Safety Standard Housings	
IEC 60529	IP10

* No TUV Recognition

¹ Based on: 105°C rated or better cable of the largest size, Properly calibrated APP® recommended tooling, and a 25°C ambient temperature. UL rating not to exceed the maximum operating temperature. CSA rating below a 30°C temperature rise.

² Limited by the thermal properties of the connector plastic housing.

³ Use APP® recommended tooling only. Alternate tools may adversely affect the performance of our connectors along with UL and CSA recognition.



| PP15-45 TEMPERATURE CHARTS |

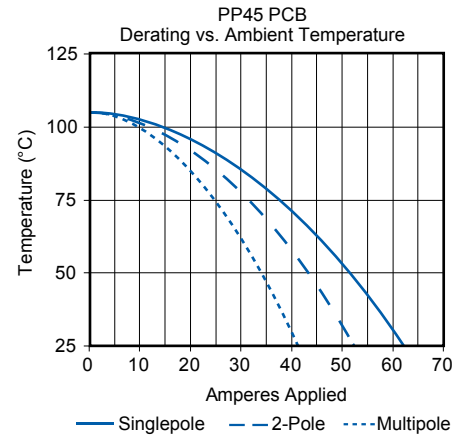
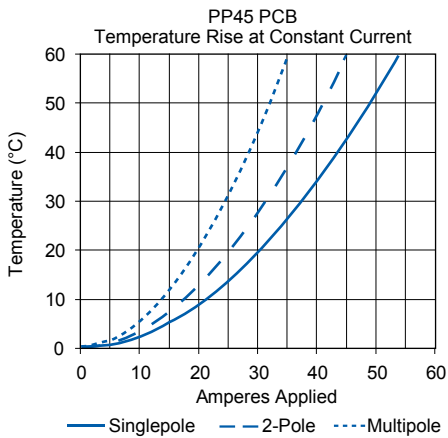
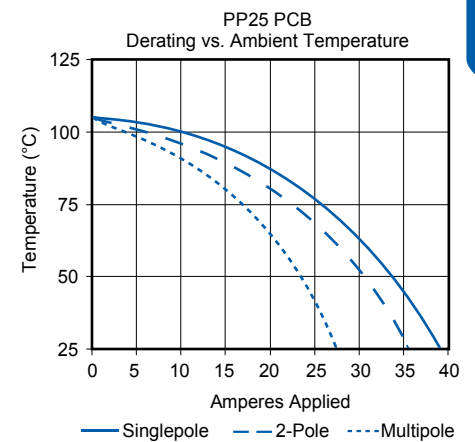
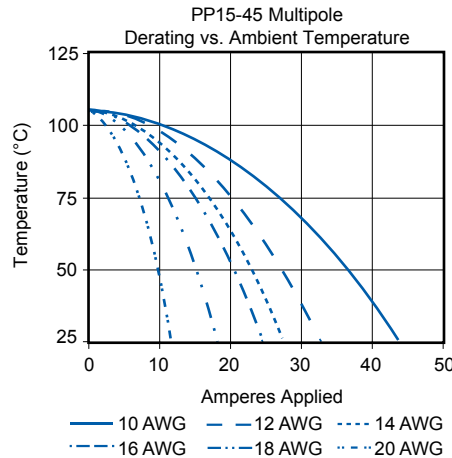
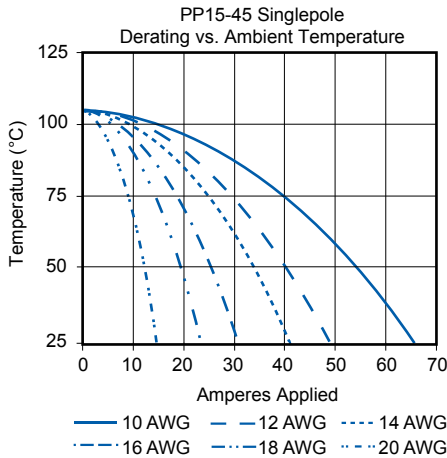
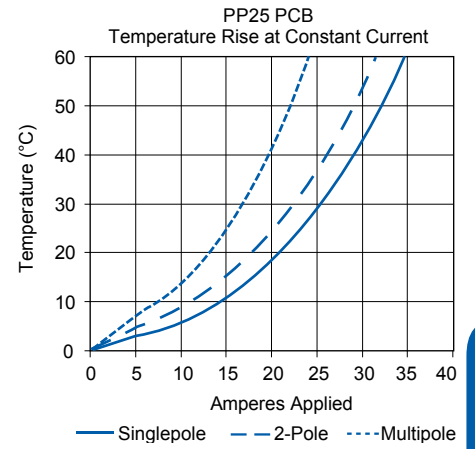
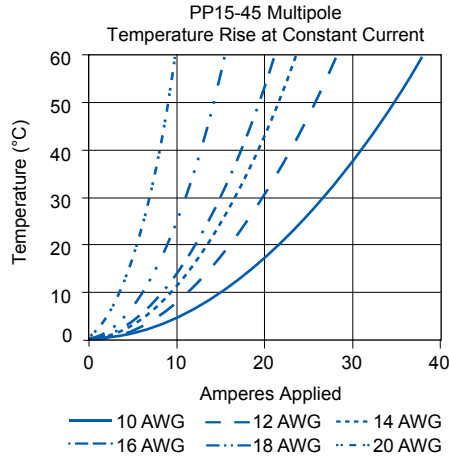
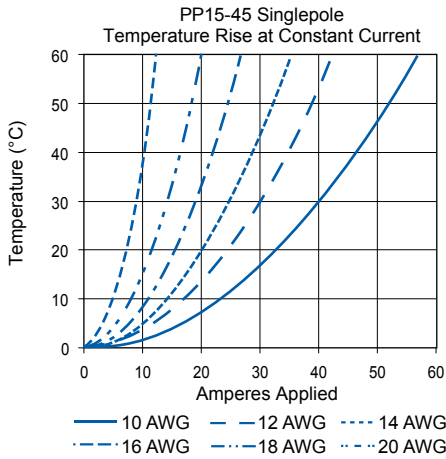

NOTE: Temperature rise charts are based on a 25°C ambient temperature. PP25 PCB charts based on 0.002 in² foil on board side, mated to #12 AWG conductor on wire side. PP45 PCB charts based on #10 AWG equivalent copper foil on board side, mated to #10 AWG conductor on wire side.

| Powerpole® 15-45 Accessories |

Mounting Wing

Secure dovetailed Powerpole® 15-45 series housings by passing fasteners through the wings in either a horizontal or vertical orientation. Useful for sheet metal panels, printed circuit boards, and many other mounting surfaces. Fasteners not included.

Description	----- Part Numbers -----	
Minimum Quantity ...	2,500	100
Red	1399G9-BK	1399G9
Blue	1399G8-BK	1399G8

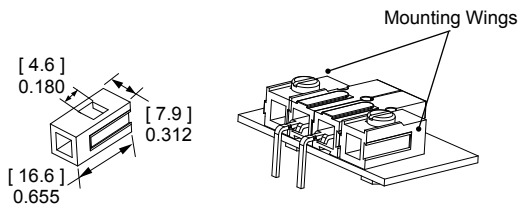

Spacer

Used to separate housings under high power to minimize derating. They are recommended for squaring off a block of Powerpole® 15-45 housings for use in connector shells and mounting clamps. Use a combination of long and short spacers opposite each other in a mated block to add keying features or use two short spacers to avoid interference. Spacers with holes can also be used to fasten the blocked housings to a surface with a fastener.

Description	----- Part Numbers -----	
Minimum Quantity	2,500	100
Red, Short w/ Hole	1399G1-BK	1399G1
Red, Long	1399G2-BK	1399G2
Red, Short	1399G6-BK	1399G6
Black, Long	1399G10-BK	1399G10
Blue, Short	1399G13-BK	1399G13
White, Short w/ Hole	1399G14-BK	1399G14
White, Long	1399G17-BK	1399G17

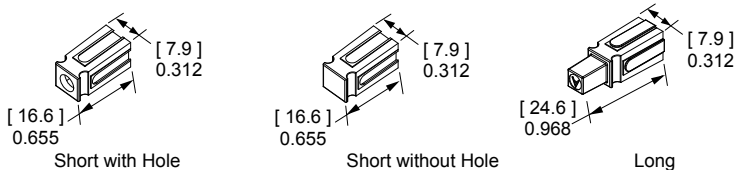

Retaining Pins

Keep stacked Powerpole® 15-45 series housings from separating. Retaining pins are inserted in the circular opening between two housings stacked side by side.

Description	----- Part Numbers -----		Dimensions			
			- A -		- B -	
	inches	mm	inches	mm		
Minimum Quantity ...	1,000	100				
1 Block High	H1507P38	110G16	0.094	2.390	0.250	6.350
2 Block High	111812P5	110G17	0.099 / 0.106	0.251 / 2.69	0.440	11.180

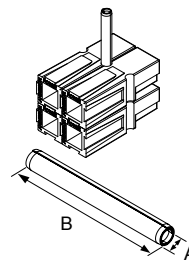

Mounting Clamp

Mounting clamps can be used for fastening a block of Powerpole® 15-45 series housings to a panel. Connector blocks must be a complete square for the clamps to work properly. Fastening hardware not included.

Description	-- Part Numbers --
Minimum Quantity ...	100 sets of 2
2 or 4 Pole	1462G1
3 or 6 Pole	1462G2
4 or 8 Pole	1462G3

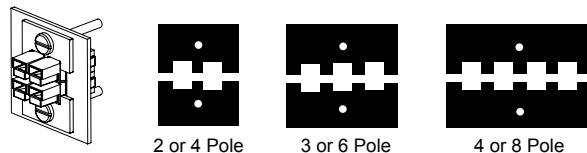

PCB Mounting Staples

PCB staples are soldered into place to secure Powerpole® 15-45 series housings in a horizontal configuration to the board. Reduce strain on soldering joints during mating and unmating.

Part Numbers	H x W	Length	Dimensions			
			- A -		- B -	
			inches	mm	inches	mm
Minimum Quantity 100						
114555P1	1 x 1	Short	0.47	12.0	0.28	7.0
114555P2	1 x 2	Short	0.47	12.0	0.57	14.5
114555P11	1 x 2	Long	0.67	17.0	0.57	14.5
114555P3	1 x 3	Short	0.47	12.0	0.89	22.5
114555P7	1 x 4	Short	0.47	12.0	1.20	30.5
114555P12	1 x 4	Long	0.67	17.0	1.20	30.5
114555P8	1 x 6	Short	0.47	12.0	1.83	46.5
114555P13	2 x 2	Long	0.91	23.0	1.83	46.5
114555P10	2 x 1	Short	0.79	20.0	0.28	7.0
114555P6	2 x 2	Short	0.79	20.0	0.57	14.5
114555P9	5 x 2	Long	0.91	23.0	0.57	14.5
114555P14	2 x 5	Long	0.91	23.0	1.52	38.5
114555P4	3 x 2	Short	1.10	28.0	0.57	14.5

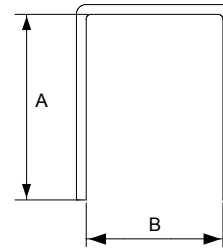

Retention Clip

Retention clips prevent Powerpole® 15-45 blocks from unintended disconnects. They feature a tab for easy insertion and removal.

Description	-- Part Number --
Minimum Quantity	100
1 Block High	110G68

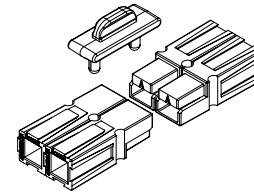

Block Lok

Block locks secure mated Powerpole® 15-45 series housings together. For use in high vibration or shock applications where connectors are unmated infrequently.

Description	- Part Numbers -
Minimum Quantity	100
2 Pole, Black	110G21
4 Pole, Black	110G12

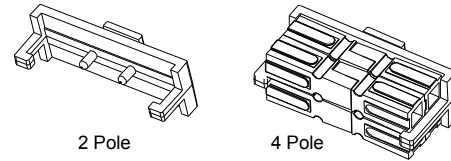

Shown without Powerpoles® Shown with Powerpoles®

Splash Boot

Splash boots protect a 2x2 block of any combination of Powerpole® 15-45 series housings and feature snip off sealed ends for flexibility in wire O.D. Designed for through panel or inline applications. Not a hermetic seal.

Description	- Part Numbers -
Minimum Quantity	25
Female, Black	1441G1
Male, Black	1442G1

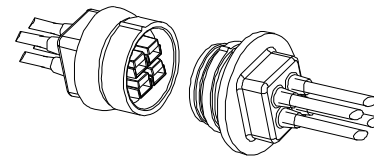

For environmentally sealed connector shells to hold Powerpole® 15-180 connectors, see APP®'s SPEC Pak® product series on our website, www.andersonpower.com



Powerpole® Connectors - PP75: up to 120 Amps

PP75 with
Mounting Wings

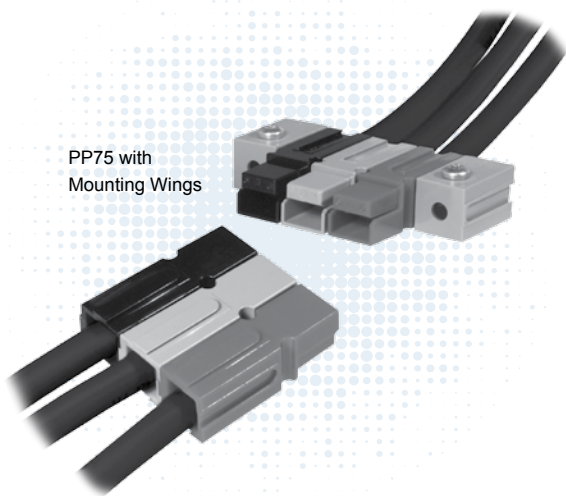

SECTION 2
Powerpole® PP75

PP75 series Powerpole® housings can be used for wire-to-wire, wire-to-board, and wire-to-busbar applications. Wire sizes from #16 AWG (1.3 mm²) to #6 (13.3 mm²) offer power capabilities up to 120 amps per pole. Locking housings offer the capability to secure Powerpole® housings to each other and to mounting pads. Housings made from chemical resistant (CR) resin withstand industrial solvents better than standard housings.

- **Large Wire Range Accommodates up to #6 (10mm²) Wire**
Reducing bushings allow as small as #16 (1.5 mm²) wire to be used
- **Wire, PCB, and Busbar Contacts**
Allows one connection system to meet multiple needs
- **Mini-Powerclaw PCB Contacts Minimize PCB Footprint**
Removes the PP75 housing from the board side

| PP75 ORDERING INFORMATION |

PP75 Standard Housings

The second smallest Powerpole® housing can be used with wire contacts for up to 6 AWG [10mm²] as well as PCB and busbar contacts.

Description	----- Part Numbers -----	
Minimum Quantity ...	1,000	100
Red	5916G7-BK	5916G7
Green	5916G6-BK	5916G6
Black	5916G4-BK	5916G4
White	5916G5-BK	5916G5
Blue	5916-BK	5916
Yellow	5916G15-BK	5916G15
Orange	5916G14-BK	5916G14
Gray	5916G16-BK	5916G16

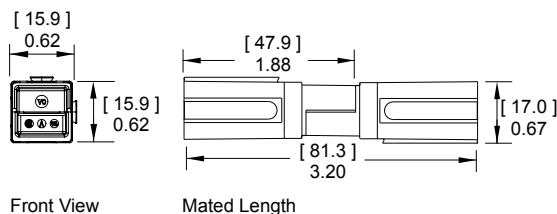

PP75 Chemical Resistant (CR) Housings

Has the same form and dimensions of the standard PP75 housing in a chemical resistant PBT/ PC blend housing. Suitable for use to -40°C.

Description	- Part Numbers -
Minimum Quantity ...	1,000
Red	P5916G7-BK
Black	P5916G4-BK
White	P5916G5-BK
Blue	P5916-BK

Material ID Located Here
V0 = Standard
P = Chemical Resistant



PP75 Locking Dovetail Housings

Offers dovetails for stacking housings that have a locking feature to prevent housings separating. Can mate to standard and chemical resistant housings, but cannot be stacked with them.

Description	----- Part Numbers -----	
Minimum Quantity	1,000	100
Red	75LOKRED-BK	75LOKRED
Green	75LOKGRN-BK	75LOKGRN
Black	75LOKBLK-BK	75LOKBLK
White	75LOKWHT-BK	75LOKWHT
Blue	75LOKBLU-BK	75LOKBLU
Gray	75LOKGRA-BK	75LOKGRA

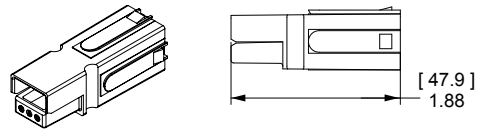

PP75 Silver Plated Wire Contacts

Silver plated contacts offer the best electrical performance and durability up to 10,000 mating cycles.

AWG	mm ²	Mating Force	Loose Piece		Dimensions - A -	
			-- Part Numbers --		inches	mm
Minimum Quantity			1,000	100		
6	13.3	Low	1307-BK	1307	0.22	5.59
6	13.3	High	5900-BK	5900	0.22	5.59
8	8.4	High	5952-BK	5952	0.19	4.83
12 to 10	3.3 to 5.3	Low	5953-BK	5953	0.14	3.56
12 to 10	3.3 to 5.3	High	5915-BK	5915	0.14	3.56

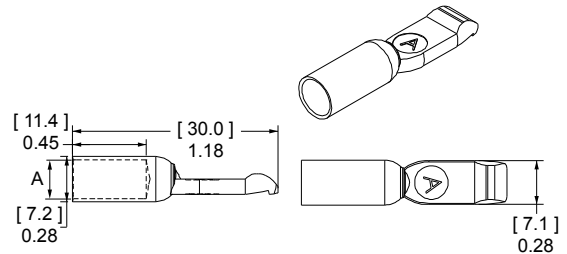

PP75 Tin Plated Reeled Wire Contacts

Reeled contacts are for use with the recommended high volume press and applicator tooling. Tin plating is rated for up to 1,500 mating cycles. Silver plated or low mating force contacts may be available for high volume applications. Inquire with customer service.

AWG	mm ²	Reeled Mating Force	Part Numbers	Dimensions - B -			
				inches	mm	inches	mm
Minimum Quantity			2,000				
8 to 6	8.4 to 13.3	High	265G5	0.26	6.60	0.36	9.14
12 to 10	3.3 to 5.3	High	265G6	0.17	4.32	0.29	7.37

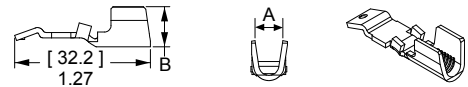

PP75 Silver Plated Busbar Contacts

Provide a quick disconnect input or output busbar connection. Busbar contacts are for mating with wire contacts only. Part number 75BBS includes lock nuts. Locknuts must be ordered separately for B01956P4.

Type	Thread	Mating Force	----- Part Numbers -----			
Minimum Quantity			1,000	120	20	10
Busbar	#10-24	High	B01956P4	B01956P4	-	75BBS
Lock Nut	#10-24	-	H1216P8	-	110G54	-

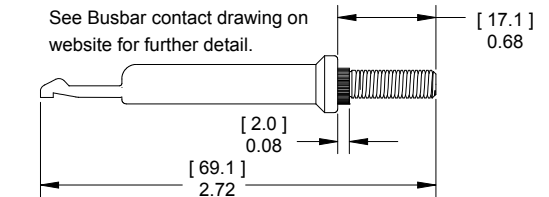

55A Right Angle Standard Powerclaw PCB Contacts

Standard Powerclaw contacts are for use inside a PP75 housing and provide a color coded right angle connection to the PCB.

Description	--- Loose Piece Part Numbers ---	
Minimum Quantity	500	100
Tin Plated	PC5930T-BK	PC5930T
Silver Plated	PC5930S-BK	PC5930S

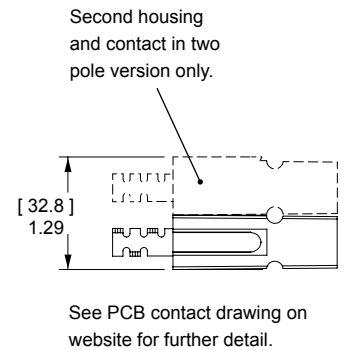
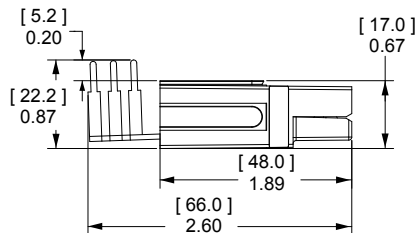
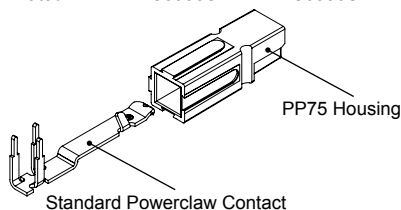

55A Right Angle Mini Powerclaw PCB Contacts

Right angle Mini Powerclaw contacts can be used on the PCB edge without a PP75 housing on the PCB side. A self polarizing design only allow PP75 wire housings to mate to PCB contacts one way.

Description	Loose Piece	
	----- Part Numbers -----	
Minimum Quantity ...	1,000	100
Tin Plated	PC5934T-BK	PC5934T
Silver Plated	PC5934S-BK	PC5934S

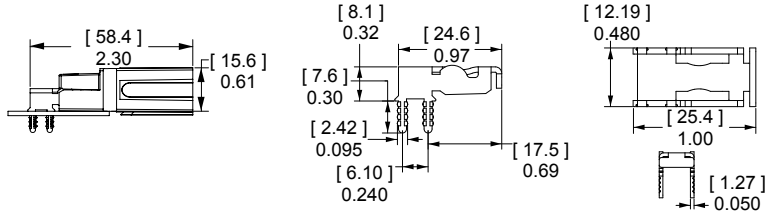

55A Vertical Mini Powerclaw PCB Contacts

Vertical Mini Powerclaw contacts save space by not requiring a PP75 housing on the PCB side. The guide housing is required for 2 pole applications to provide a polarized connection. (See PP75 accessories).

Description	Loose Piece	
	----- Part Numbers -----	
Minimum Quantity ...	1,500	100
Tin Plated	PC5933T-BK	PC5933T
Silver Plated	PC5933S-BK	PC5933S

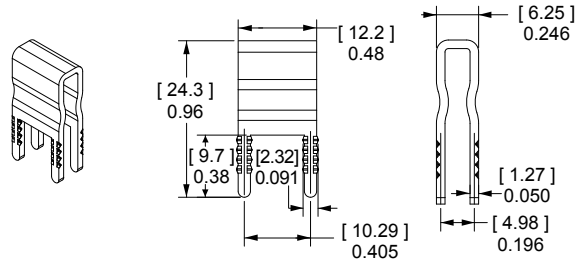

See PCB contact drawing on website for further detail.

PP75 TEMPERATURE CHARTS |

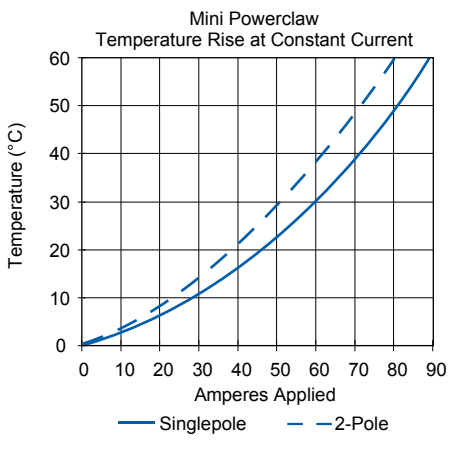
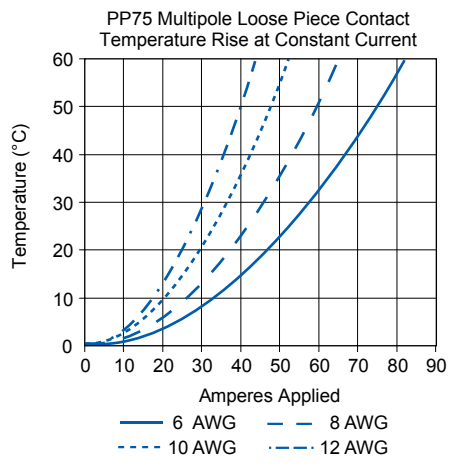
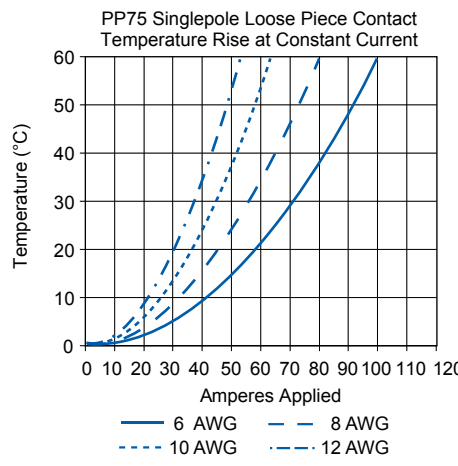
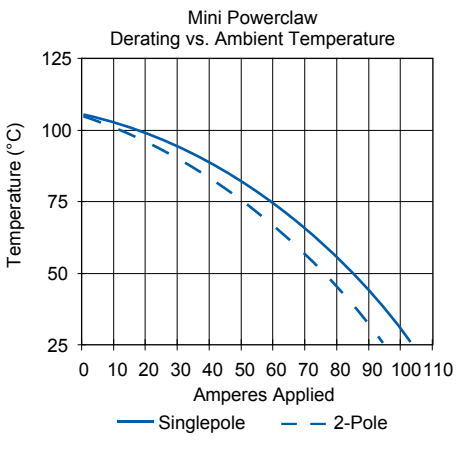
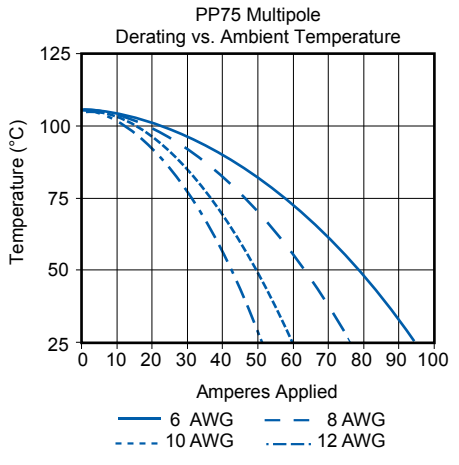
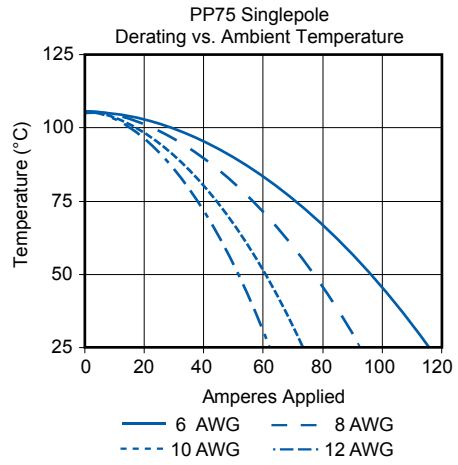

NOTE: Temperature rise charts are based on a 25°C ambient temperature. Powerclaw charts are based on #8 AWG equivalent copper foil on board side, mated to #6 AWG conductor on wire side.

PP75 SPECIFICATIONS |

Electrical		
Current Rating Amperes¹	UL 1977	CSA
Wire to Wire (6 AWG)	120	70
Wire to PCB (6-AWG)	55	50
Wire to Busbar (6 AWG)	75	
Voltage Rating AC/DC		
UL 1977	600	
PCB Connector Recommended Voltage³		
per IEC 60950-1 Table 2L Pollution Degree²		
Mini Vert. Contact Adjacent Poles	220	
Mini Horiz. Contact Adjacent Poles	200	
Standard Contact Adjacent Poles	635	
Dielectric Withstanding Voltage		
Volts AC	2,200	
Avg. Mated Contact Resistance Milliohms¹		
Wire Contact with 1 1/4" of #6 AWG	0.200	
PCB Contact to Contact	0.500	
UL Hot Plug Current Rating Amperes - 250 cycles at 120V DC		
Wire- wire	50A	
PCB- wire (Vertical Mini Powerclaw)	40A	

Materials	
Housing	
Standard Plastic Resin	Polycarbonate
Chem. Resistant Resin	Polycarbonate / PBT blend
Contact Retention Spring	Stainless Steel
Housing Flammability Rating	
UL94	V-0
Contact	
Base	Copper Alloy
Wire Plating	Silver
PCB Plating	Sn or Ag over Ni
Contact Termination Methods	
Crimp [*]	Wire Contacts
Hand Solder	Wire and PCB Contacts
Solder Dip [*]	PCB Contacts
Wave Solder [*]	PCB Contacts
Wrench / Socket	Busbar Contacts

Mechanical		
Wire Size Range	AWG	mm²
	16 to 6	1.3 to 13.3
Max. Wire Insulation Diameter	in.	mm
	0.437	11.100
Operating Temperature²	°F	°C
Standard	-4° to 221°	-20° to 105°
Chemical Resistant [*]	-40 to 221°	-40° to 105°
*Chemical resistant material not available for PCB guide housings		
Mating Cycles No Load by Plating	Silver (Ag)	Tin (Sn)
Wire and PCB Contacts	10,000	1,500
Avg. Mating / Unmating Force	Lbf.	N
Wire to Wire Low Force Contacts	5	22
Wire to Wire High Force Contacts	7	31
Standard Powerclaw to Wire	7	31
Mini Powerclaw to Wire	4	17
PCB Specifications		
Mounting Style	Plated Through Hole	
Max PCB Thickness- in. [mm]	Standard: 0.15 [0.381]	
	Mini: 0.25 [0.635]	
Recommended Traces	#8 AWG Cross Section	
Min. Contact / Spring Retention Force	Lbf.	N
Wire Housing	50	222
Min. Creepage / Clearance Distance PCB in.		mm
Standard Powerclaw Adjacent Poles	0.260	6.6
Mini Vert. Powerclaw Adjacent Poles	0.087	2.2
Mini Horiz. Powerclaw Adjacent Poles	0.079	2.0

Protection	
Touch Safety with Wire Contacts	
IEC 60529	IP10

¹ Based on: 105°C rated or better cable of the largest size, Properly calibrated APP® recommended tooling, and a 25°C ambient temperature. UL rating not to exceed the maximum operating temperature. CSA rating below a 30°C temperature rise.

² Limited by the thermal properties of the connector plastic housing.

³ Without use of spacers to increase creepage and clearance distances.

⁴ Use APP® recommended tooling only. Alternate tools may adversely affect the performance of our connectors along with UL and CSA recognition.

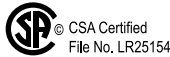

| Powerpole® PP75 Accessories |

Strain Relief Grommets

Use for strain relief in the back side of a PP75 housing. Wire gauge given for reference only, use grommet ID and wire OD to determine suitability in the end application.

Description	- Part Numbers -	Dimensions	
		- A -	
		inches	mm
Minimum Quantity ...	100	
#6 AWG, Black	114411P2	0.35	8.89
#8 AWG, Black	114411P1	0.25	6.35
#10 - 12 AWG, Black	114411P3	0.17	4.32

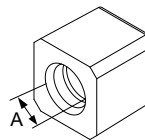

Mounting Wing for Standard or CR Housings

Mounting wings can be used to secure dovetailed Powerpole® 75 series housings by passing fasteners through the wings in either a horizontal or vertical orientation. Useful for sheet metal panels, printed circuit boards, and many other mounting surfaces. Fasteners not included.

Description	----- Part Numbers -----	
Minimum Quantity ...	1,000	100 ...
Blue, Round Hole	1399G20-BK	1399G20
Blue, Oval Hole	1399G7-BK	1399G7

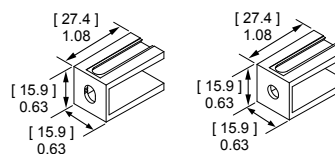

Mounting Wing for Locking Housings

Mounting wings can be used to secure Powerpole® 75 series housings with locking dovetails by passing fasteners through the wings in either a horizontal or vertical orientation. Useful for sheet metal panels, printed circuit boards, and many other mounting surfaces. Fasteners not included.

Description	----- Part Numbers -----	
Minimum Quantity ...	1,000	100 ...
Blue, Oval Hole	75LOKWNGBLU-BK	75LOKWNGBLU
Blue, Round Hole	75LOKWNGBLU-R-BK	75LOKWNGBLU-R

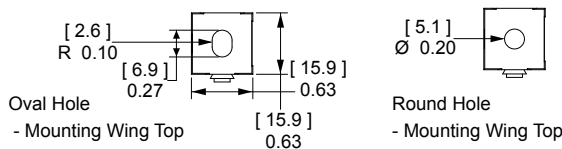

Left Side View
- Both Versions

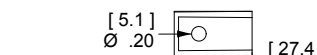

Right Side View
- Both Versions

Surface Mount for Locking Housings

Use to secure Powerpole® 75 series housings with locking dovetails to a flat surface. Useful for sheet metal panels, printed circuit boards, and many other mounting surfaces. Fasteners not included.

Description	----- Part Numbers -----	
Minimum Quantity ...	1,000	100 ...
Blue	75LOKSMTBLU-BK	75LOKSMTBLU

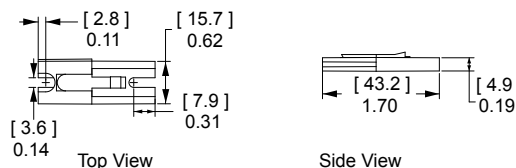

Guide Housings for Vertical Mini Powerclaw Contacts

Prevents polarity being reversed when a two pole PP75 block is mated to vertical mini Powerclaw contacts. Fastening hardware not included.

Description	Part Numbers	
Minimum Quantity ...	1,000	100 ...
Black Guide Housing	PC-HSG-PP-BK	PC-HSG-PP

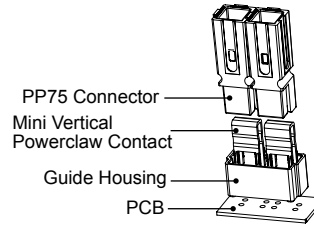

Mounting Clamp

Mounting clamps can be used for fastening a block of Powerpole® 75 series housings to a panel. Connector blocks must be a complete square for the clamps to work properly. Fastening hardware not included.

Description	Part Numbers	
Minimum Quantity ...	50 sets of 2 ...	
2 or 4 Pole	1463G1	
3 or 6 Pole	1463G2	

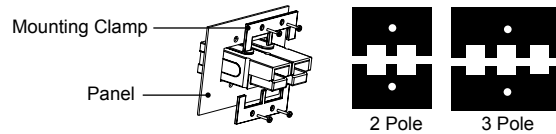

Retaining Pins

Retaining pins are used to keep stacked Powerpole® 75 series housings from separating. Retaining pins are inserted in the circular opening between two housings stacked side by side. Dimension B is +/- 0.015 in or 0.38 mm.

Description	Part Numbers		Dimensions			
			- A -		- B -	
	inches	mm	inches	mm		
Minimum Quantity ...	1,000	100				
1 Block High	111812P7	110G19	0.196 / 0.207	4.98 / 5.26	0.560	14.220
2 Block High	111812P6	110G18	0.196 / 0.207	4.98 / 5.26	1.000	25.400

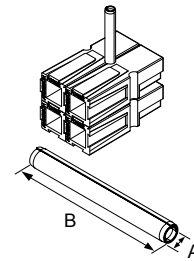

PCB Mounting Staples

Reduce strain on solder joints during mating and unmating. Staples bend over the underside of the PCB board to lock the housings in place. Staples are an interference fit with housings.

Part Numbers	Number of Stacked Powerpoles®	H x W
Minimum Quantity ...	100	
PCSTAPLE-1	1 x 1	
PCSTAPLE-2	1 x 2	

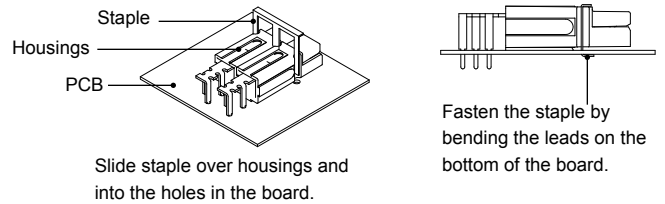

Reducing Bushings

Use with contact part number 5900-BK or 1307-BK to allow a smaller wire to be used with the connector. Electrical capability is derated with smaller wire.

Contact Barrel Size	Wire Size	Part Numbers			Dimensions			
		inches	mm	inches	mm	inches	mm	
Minimum Quantity ...		3,000	1,000	100				
#6 AWG [13.3 mm²]	#8 AWG [8.4 mm²]	-	5912-BK	5912	0.18	4.57	0.45	11.43
#6 AWG [13.3 mm²]	#12- 10 AWG [3.3- 5.3 mm²]	5910-BK	-	5910	0.14	3.56	0.47	11.94
#6 AWG [13.3 mm²]	#16- 14 AWG [1.3- 2.1 mm²]	5913-BK	-	5913	0.09	2.29	0.47	11.94

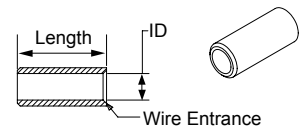

For environmentally sealed connector shells to hold Powerpole® 15-180 connectors, see APP®'s SPEC Pak® product series on our website, www.andersonpower.com



Powerpole® Connectors

- PP120: up to 240 Amps

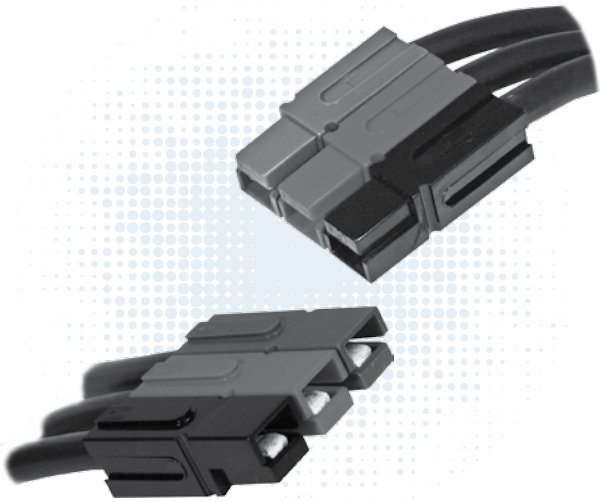

PP120 series Powerpole® housings are designed to accommodate up to 1/0 (50 mm²) wires and handle high currents up to 240 amps. Reducing bushings allow PP120 to accept down to #8 (10 mm²) wires. Multiple colors of stackable housings combine with APP®'s low resistance flat wiping technology to offer powerful connection capability.

- **Large Wire Range Accommodates up to 1/0 (50mm²) Wire**
Reducing bushings allow as small as #8 (10 mm²) wire to be used
- **Low Resistance Silver Plated Copper Contacts**
Allows currents up to 240 amps
- **UL Rated for Hot Plugging up to 60 Amps**
Great for battery or other applications where the ability to interrupt circuits is required

PP120 ORDERING INFORMATION |

PP120 Housings

The second to largest Powerpole® housing can be used with wire contacts for up to 1/0 AWG [50mm²] or busbar contacts.

Description	----- Part Numbers -----	
Minimum Quantity ...	500	50
Red	1321G3-BK	1321G3
Green	1321G4-BK	1321G4
Black	1321G1-BK	1321G1
White	1321G2-BK	1321G2
Blue	1321-BK	1321
Gray	1321G8-BK	1321G8

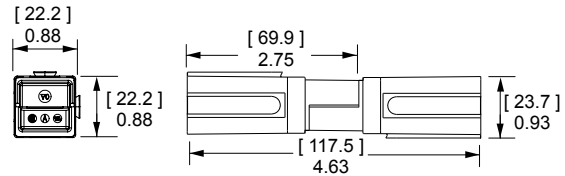

PP120 Silver Plated Wire Contacts

Silver plated contacts offer superior electrical performance and durability up to 10,000 mating cycles. New contacts for #1 to 1/0 AWG (35 to 50 mm²) offer extended capability in the same housings.

AWG	mm ²	Mating Force	----- Loose Piece Part Numbers -----			- A -		- B -	
			600	500	50	inches	mm	inches	mm
1/0	53.5	Low	1323G2-BK	-	1323G2	0.52	13.21	0.44	11.18
1	42.4	Low	1323G1-BK	-	1323G1	0.47	11.94	0.39	9.91
2	33.6	Low	-	6811G6-BK	6811G6	0.44	11.18	0.22	5.59
2	33.6	High	-	1319-BK	1319	0.44	11.18	0.22	5.59
4	21.1	Low	-	6811G5-BK	6811G5	0.44	11.18	0.30	7.62
4	21.1	High	-	1319G4-BK	1319G4	0.44	11.18	0.30	7.62
6	13.3	Low	-	6811G4-BK	6811G4	0.44	11.18	0.34	8.64
6	13.3	High	-	1319G6-BK	1319G6	0.44	11.18	0.34	8.64

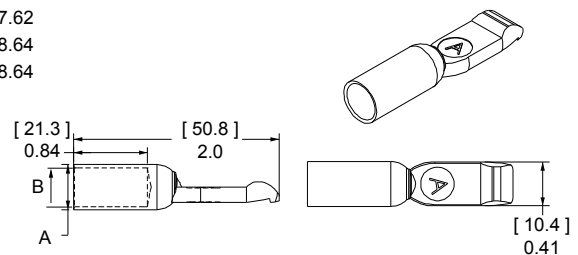

PP120 SPECIFICATIONS |

Electrical		
Current Rating Amperes¹	UL 1977	CSA
Singlepole UL 1977 (1/0 AWG)	240	155
2x2 Block UL 1977 (1/0 AWG)	200	110
Voltage Rating AC/DC		
UL 1977	600	
Dielectric Withstanding Voltage		
Volts AC	2,200	
Avg. Mated Contact Resistance Milliohms¹		
5 1/2" of #2 AWG wire	0.136	
UL Hot Plug Current Rating Amperes		
250 cycles at 120V DC	60A	

Mechanical		
Wire Size Range	AWG	mm²
	10 to 1/0	5.3 to 53.5
Max. Wire Insulation Diameter	in.	mm
	0.600	15.240
Operating Temperature²	°F	°C
	-4° to 221°	-20° to 105°
Mating Cycles No Load by Plating	Silver (Ag)	
Wire Contacts	10,000	
Avg. Mating / Unmating Force	Lbf.	N
	8	36
Min. Contact / Spring Retention Force	Lbf.	N
	60	267

Materials	
Housing	
Plastic Resin	Polycarbonate
Contact Retention Spring	Stainless Steel
Housing Flammability Rating	
UL94	V-0
Contact	
Base	Copper Alloy
Plating	Silver
Contact Termination Methods	
Crimp ³	Wire Contacts
Hand Solder	Wire Contacts

Protection	
Touch Safety with Wire Contacts	
IEC 60529	IP10

¹ Based on: 105°C rated or better cable of the largest size, Properly calibrated APP® recommended tooling, and a 25°C ambient temperature. UL rating not to exceed the maximum operating temperature. CSA rating below a 30°C temperature rise.
² Limited by the thermal properties of the connector plastic housing.
³ Use APP® recommended tooling only. Alternate tools may adversely affect the performance of our connectors along with UL and CSA recognition.



PP120 TEMPERATURE CHARTS |

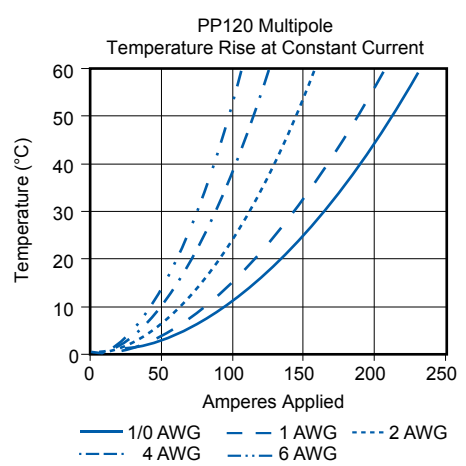
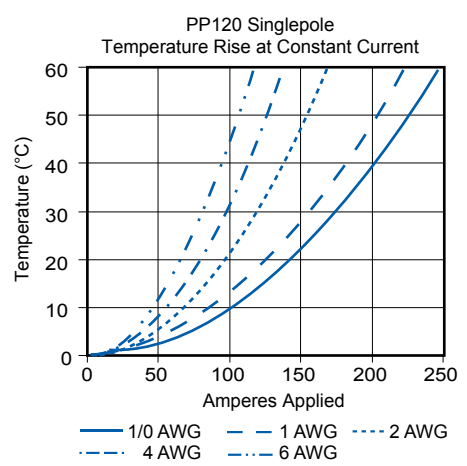

NOTE: Temperature rise charts are based on a 25°C ambient temperature.

[Derating charts on the following page.](#)

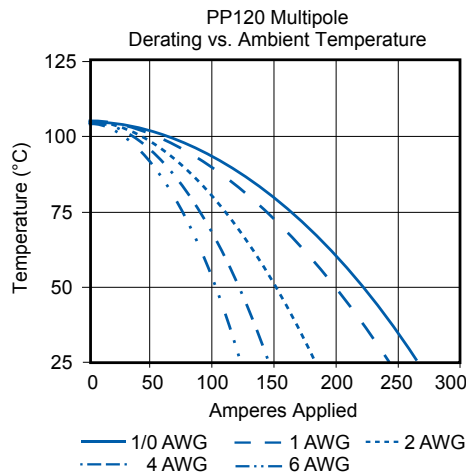
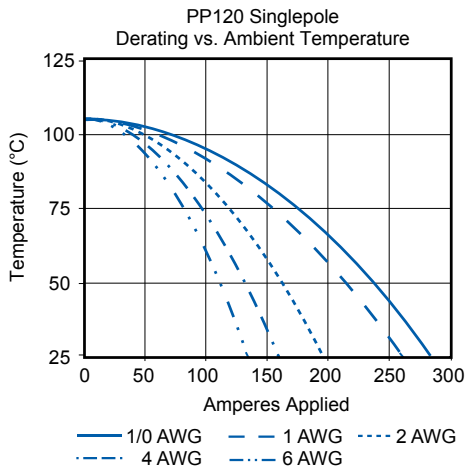

| Powerpole® PP120 Accessories |

Mounting Clamp

Mounting clamps can be used for fastening a block of Powerpole® 120 series housings to a panel. Connector blocks must be a complete square for the clamps to work properly. Fastening hardware not included.

Description	- Part Numbers -
Minimum Quantity ...	20 sets of 2
2 Pole	1464G1
3 Pole	1464G2

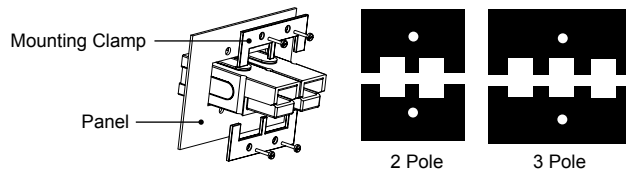

Retaining Pins

Retaining pins are used to keep stacked Powerpole® 120 series housings from separating. Retaining pins are inserted in the circular opening between two housings stacked side by side. Dimension B is +/- 0.015 in or 0.38 mm.

Description	----- Part Numbers -----		Dimensions			
			- A -		- B -	
Minimum Quantity ...	1,000	100	inches	mm	inches	mm
1 Block High	111812P7	110G19	0.196 / 0.207	4.98 / 5.26	0.560	14.220
2 Block High	111812P8	110G20	0.196 / 0.207	4.98 / 5.26	1.500	38.100

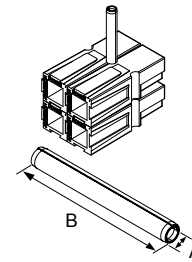

Reducing Bushings

Use with contact part number 1319-BK or 6811G6-BK to allow a smaller wire to be used with the connector. Electrical capability is derated with smaller wire.

Contact Barrel Size	Wire Size	----- Part Numbers -----			Dimensions - ID -	
		2,000	1,000	100	inches	mm
#2 AWG [33.6 mm²]	#4 AWG [21.2 mm²]	5919-BK	-	5919	0.28	7.11
#2 AWG [33.6 mm²]	#6 AWG [16 mm²]	-	5920-BK	5920	0.23	5.84
#2 AWG [33.6 mm²]	#10 - 8 AWG [5.3 - 8.4 mm²]	5921-BK	-	5921	0.18	4.57

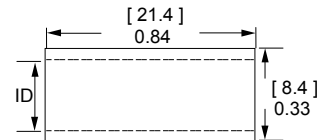

For environmentally sealed connector shells to hold Powerpole® 15-180 connectors, see APP®'s SPEC Pak® product series on our website, www.andersonpower.com



Powerpole® Connectors - PP180: up to 350 Amps

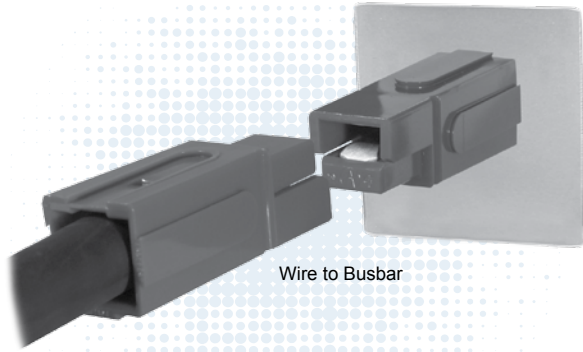

PP180 are the largest of the Powerpole® series housings. They are designed to accommodate up to 3/0 (70 mm²) wires and handle high currents up to 350 amps. Busbar contacts are also available for power inputs and takeoffs. Color-coded housings minimize user confusion and the potential of cross mating circuits.

Low Resistance Silver Plated Copper Contacts

- Allows currents up to 350 amps

UL Rated for Hot Plugging up to 75 Amps

- Great for battery or other applications where the ability to interrupt circuits is required

Busbar Contacts Work with Standard Housings

- Provides a hot swappable quick disconnect system for busbar power distribution

| PP180 ORDERING INFORMATION |

PP180 Housings

The largest Powerpole® housing can be used with wire contacts for up to 3/0 AWG [85mm²] or busbar contacts.

Description	----- Part Numbers -----	
Minimum Quantity ...	250	50
Red	1381G3-BK	1381G3
Green	1381G4-BK	1381G4
Black	1381G1-BK	1381G1
White	1381G2-BK	1381G2
Blue	1381-BK	1381

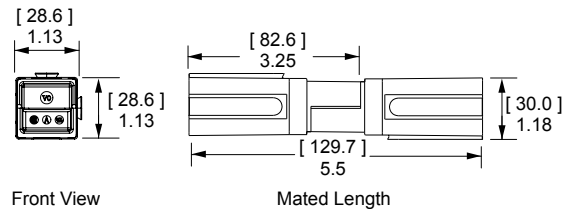

PP180 Silver Plated Wire Contacts

Silver plated contacts offer superior electrical performance and durability up to 10,000 mating cycles. New contacts for 2/0 to 3/0 AWG (70 to 85 mm²) offer extended capability in the same housings.

AWG	mm ²	Mating Force	----- Loose Piece Part Numbers -----				Dimensions								
			500	300	250	50	- A -	- B -	- C -	- D -	inches	mm	inches	mm	inches
3/0	85	Low	-	-	1328G2-BK	1328G2	2.35	59.69	0.70	17.78	0.58	14.73	1.04	26.42	
2/0	67.4	Low	-	1328G1-BK	-	1328G1	2.35	59.69	0.64	16.26	0.49	12.45	1.04	26.42	
1/0	53.5	High	1382-BK	-	-	1382	2.35	59.69	0.52	13.21	0.44	11.18	1.04	26.42	
1	42.4	High	1347-BK	-	-	1347	2.35	59.69	0.52	13.21	0.39	9.91	1.04	26.42	
2	33.6	High	1383-BK	-	-	1383	2.35	59.69	0.52	13.21	0.35	8.89	1.04	26.42	
4	21.1	High	1384-BK	-	-	1384	2.35	59.69	0.52	13.21	0.30	7.62	1.04	26.42	
6	13.3	High	1348-BK	-	-	1348	2.10	53.34	0.37	9.40	0.22	5.59	0.80	20.32	

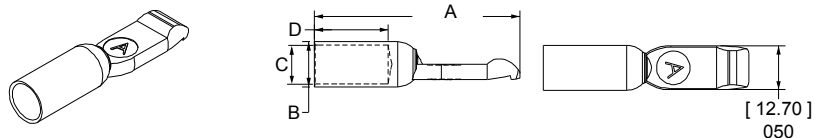

PP180 Silver Plated Busbar Contacts

Use 2 busbar contacts per housing to provide a quick disconnect input or output busbar connection. Busbar contacts are for mating with wire contacts only. Part number 180BBS includes lock nuts. Locknuts must be ordered separately for 180BBS-BK.

Thread	Mating Force	----- Loose Piece Part Numbers -----			
Minimum Quantity		1,000	120	10	
Busbar 1/4-20	High	180BBS-BK	180BBS	-	
Lock Nut 1/4-20	N/A	H1216P7	110G56	110G55	

See Busbar contact drawing on website for further detail.

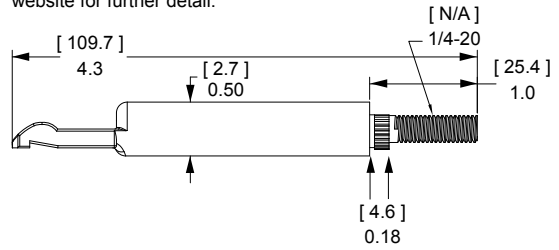

PP180 SPECIFICATIONS

Electrical

Current Rating Amperes ¹	UL 1977	CSA
Singlepole (wire-wire) (3/0 AWG)	350	230
2x2 Block (wire-wire) (3/0 AWG)	350	
Singlepole (wire-busbar) (1/0 AWG)	180	

Voltage Rating AC/DC	UL 1977
UL 1977	600

Dielectric Withstanding Voltage	Volts AC
Dielectric Withstanding Voltage	2,200

Avg. Mated Contact Resistance Milliohms ¹	6" of 1/0 AWG wire
Avg. Mated Contact Resistance Milliohms ¹	0.100

UL Hot Plug Current Rating Amperes	250 cycles at 120V DC
UL Hot Plug Current Rating Amperes	75A

Mechanical

Wire Size Range	AWG	mm ²
Wire Size Range	10 to 3/0	5.3 to 85

Max. Wire Insulation Diameter	in.	mm
Max. Wire Insulation Diameter	0.900	22.860

Operating Temperature ²	°F	°C
Operating Temperature ²	-4° to 221°	-20° to 105°

Mating Cycles No Load by Plating	Wire and Busbar Contacts	Silver (Ag)
Mating Cycles No Load by Plating	10,000	

Avg. Mating / Unmating Force	Lbf.	N
Avg. Mating / Unmating Force	10	44

Min. Contact / Spring Retention Force	Lbf.	N
Min. Contact / Spring Retention Force	120	534

Materials

Housing	
Plastic Resin	Polycarbonate
Contact Retention Spring	Stainless Steel

Housing Flammability Rating	
UL94	V-0

Contact	
Base	Copper Alloy
Plating	Silver

Contact Termination Methods	
Crimp ³	
Hand Solder	
Wrench / Socket*	

*Busbar Contacts Only

Protection

Touch Safety with Wire Contacts	
IEC 60529	IP10

¹ Based on: 105°C rated or better cable of the largest size, Properly calibrated APP® recommended tooling, and a 25°C ambient temperature. UL rating not to exceed the maximum operating temperature. CSA rating below a 30°C temperature rise.

² Limited by the thermal properties of the connector plastic housing.

³ Use APP® recommended tooling only. Alternate tools may adversely affect the performance of our connectors along with UL and CSA recognition.



| PP180 TEMPERATURE CHARTS |

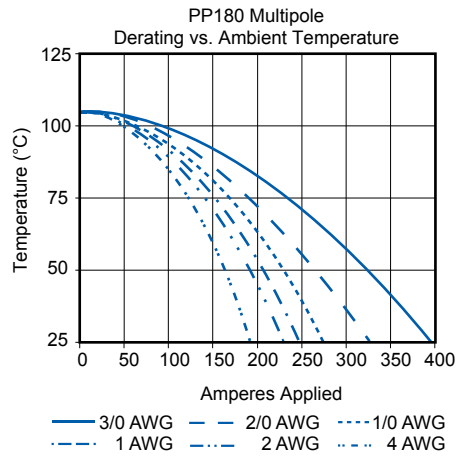
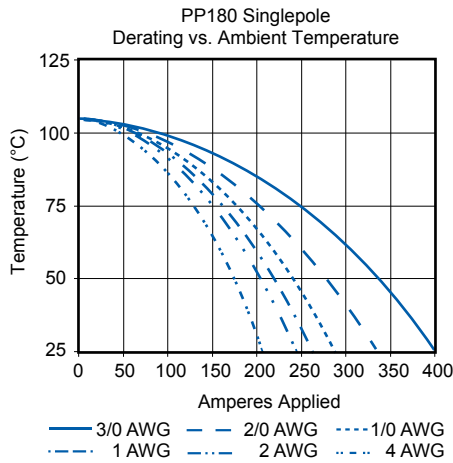
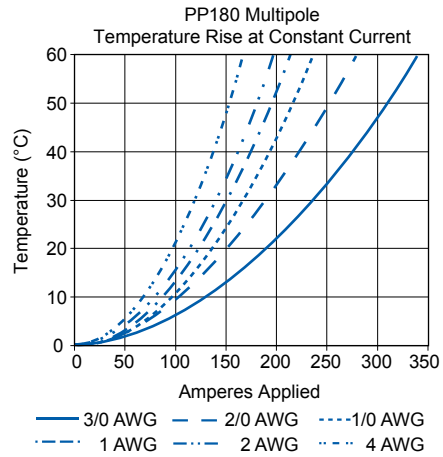
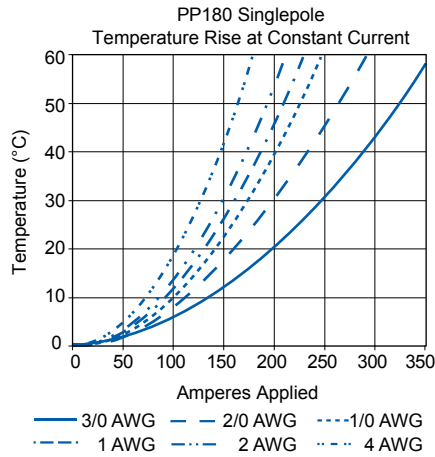

NOTE: Temperature rise charts are based on a 25°C ambient temperature.

Powerpole® PP180 Accessories |

Mounting Clamp

Mounting clamps can be used for fastening a block of Powerpole® 180 series housings to a panel. Connector blocks must be a complete square for the clamps to work properly. Fastening hardware not included.

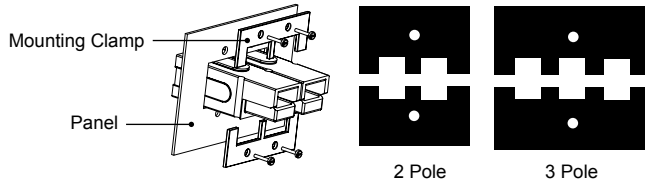

Description	- Part Numbers -
Minimum Quantity ...	20 sets of 2
2 Pole	1465G1
3 Pole	1465G2

Retaining Pins

Retaining pins are used to keep stacked Powerpole® 180 series housings from separating. Retaining pins are inserted in the circular opening between two housings stacked side by side. Dimension "B" is +/- .015 in or .38 mm.

Description	Part Numbers		Dimensions			
			- A - inches		- B - mm	
Minimum Quantity ...	1,000	100				
1 Block High	111812P6	110G18	0.196 / 0.207	4.98 / 5.26	1.000	25.400
2 Block High	111812P8	110G20	0.196 / 0.207	4.98 / 5.26	1.500	38.100

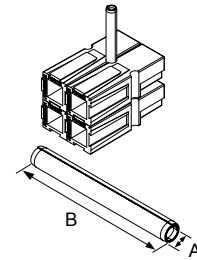

Reducing Bushings

Use with contact part number 1382-BK to allow a smaller wire to be used with the connector. Electrical capability is derated with smaller wire.

Contact Barrel Size	Wire Size	Part Numbers				Dimensions - ID -	
		1,500	1,000	500	100	inches	mm
Minimum Quantity ...		1,500	1,000	500	100		
1/0 AWG [53.5 mm²]	#1 AWG [42.4 mm²]	-	-	5687-BK	5687	0.39	9.91
1/0 AWG [53.5 mm²]	#2 AWG [33.6 mm²]	5690-BK	-	-	5690	0.34	8.64
1/0 AWG [53.5 mm²]	#4 AWG [21.2 mm²]	-	5693-BK	-	5693	0.27	6.86
1/0 AWG [53.5 mm²]	#6 AWG [13.3 mm²]	-	5663-BK	-	5663	0.22	5.59
1/0 AWG [53.5 mm²]	#10 - 8 AWG [5.3 - 8.4 mm²]	5648-BK	-	-	5648	0.19	4.83

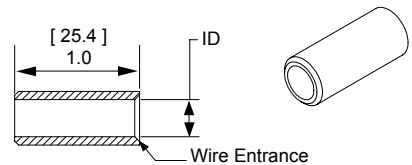

For environmentally sealed connector shells to hold Powerpole® 15-180 connectors, see APP's SPEC Pak® product series on our website, www.andersonpower.com



Powerpole® - Tooling Information

Wire Size		Loose Piece Part Numbers		Loose Piece Contact Crimp Tool					Reeled Part Numbers		Reeled Contact Crimp Tools																					
AWG	mm²	Tin Plating	Silver Plating	Hand Tool or	Pneumatic Bench Tool	+ Die	+ Locator	Number of Crimps	Tin Plating	Silver Plating	ATS Applicator	ATS Press	Air Feed Kit*																			
PP15 / 45 Flat Wiping Power & Ground																																
16 / 20	1.3 / 0.52	N/A	1332	1309G2 or 1309G8	1367G1				N/A	N/A	N/A	N/A	N/A																			
12 / 16	3.3 / 1.3	N/A	1331						262G1-LPBK 262G2-LPBK	200G2L-LPBK 200G4L-LPBK	269G2-LPBK N/A	261G1-LPBK 261G4-LPBK	261G2-LPBK 261G3-LPBK	269G1-LPBK N/A	200G1L-LPBK 200G3L-LPBK	201G1H-LPBK 201G3H-LPBK	1830G1-LPBK 1830G2-LPBK	262G1	262G2	1385519-1	1725900-2 or [3-54500-1]	1424266-1 or [354578-1]										
16 / 20	1.3 / 0.52																												200G2L	200G4L	TBD	
16 / 20	1.5 / 0.52																															
16 / 20	1.3 / 0.52																															
12 / 16	3.3 / 1.3			1309G3 or 1309G8	N/A	N/A	N/A	Single	261G1	261G4	1385520-1	1385458-1	1385520-1	261G2	261G3	1385458-1																
10 / 14	5.3 / 2.1																			269G1	N/A	1385520-1										
12 / 16	3.3 / 1.3																															
10 / 14	5.3 / 2.1			1309G6 or 1309G8	N/A	N/A	N/A	Single	269G3	N/A	1385458-1	1385458-1	1385458-1	200G1L	200G3L	1385460-1																
10 / 14	6.0 / 2.1																			201G1H	201G3H	1385460-1										
10 / 14	6.0 / 2.1																															
10 / 14	6.0 / 2.1								1830G1	1830G2	1385460-1																					
PP75																																
#6	13.3	N/A	1307	1309G4	1387G1	1388G6	1389G6	Single	265G5	N/A	1385523-1	2-565435-2	692655-1																			
			5900																													
#8	8.4		5952																													
#10 / 12	5.3 / 3.3		5953																													
			5915			1388G7			265G6		1385522-1	1725900-2 or [3-54500-1]	1424266-1 or [354578-1]																			
PP120																																
1/0	53.5	N/A	1323G2	1368	1387G1	1388G3	1389G4	Single	N/A	N/A	N/A	N/A	N/A																			
#1	42.4		1323G1																													
#2	33.6		1319																													
#4	21.2		1319G4																													
#6	13.3		1319G6																													
PP180																																
3/0	85	N/A	1328G2	1368	1387G1	1388G3	1389G3	Single	N/A	N/A	N/A	N/A	N/A																			
2/0	53.5		1328G1																													
1/0	53.5		1382																													
#1	42.4		1347																													
#2	33.6		1383																													
#4	21.1		1384																													
#6	13.3		1348																													
						1303G12	1304G32	Double																								
						1303G13																										
						1387G2	1303G13	1304G32	Double																							
						1387G1	1388G3	1389G3	Single																							
						1387G2	1303G13	1304G32	Double																							
						1387G1	1388G4	1389G3	Single																							

* All ATS applicators for APP® contacts are air feed style, (except 1385870) and require the press to have an air feed kit installed.
NOTE: See website for the most current information.

SECTION 2
Powerpole® Tooling

Multipole Family

Overview of SBS®, SB® & SBX® / SBO®

- Main Differentiating Features

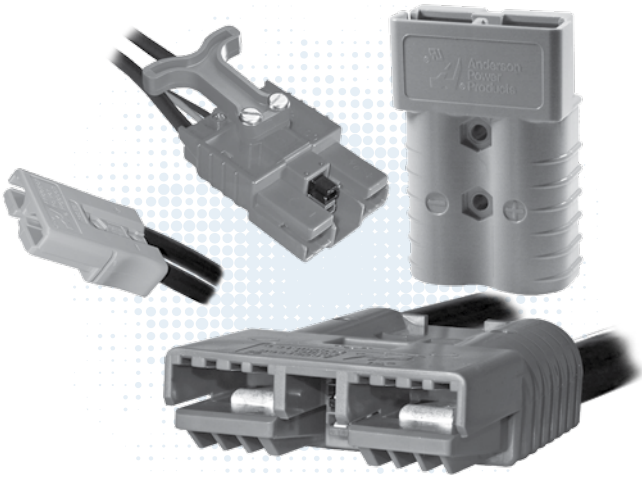

SBS®: The “Storage Battery Safety” connector provides a compact connection with a touch safe interface. The newest series of the Multipole connector continues to add new features and capabilities.

SB®: Based on the original “Storage Battery” connector that pioneered flat wiping contact technology over a half century ago. Two to three positions in a genderless mechanically-keyed housing are suitable for a wide array of power connection applications.

SBX®: The addition of auxiliary positions to the SB® created the “Storage Battery Auxiliary” connector. Up to 8 auxiliary positions allow expanded capabilities for the Multipole family by allowing intelligent power switching, monitoring of battery charge status, and other signal functions to be integrated into a single connector.

SBE®: By modifying the SBX® housing the “Storage Battery European” connector was created. The SBE® housings are molded from a chemical resistant PBT resin and the SBE®320 features improved touch safety over the SBX®350 design.

SBO®: Designed to meet the needs of connecting office equipment, the “Storage Battery Office” connector is molded out of durable PC like the original SB® but incorporates the auxiliary positions of the SBX® in a housing similar to the SBE®80.

Hot Plugging AC or DC

Contacts feature a sacrificial tip that allow high current circuit interrupt

Genderless Housings

Provide simplified assembly and minimize the number of components

Low Resistance Connection

Silver or tin plated contacts inside housings that strongly force the contacts together

Self Securing Design

Stainless steel springs create a robust force between the contacts that holds the connector in the mated condition

Keyed & Color Coded Housings

Prevents accidental cross mating of circuits

Compact Power to Size Ratio

Maximizes valuable PCB edge real estate with a compact high power design

Auxiliary or Ground Positions

For signal transmission or the added safety of a pre-mate ground

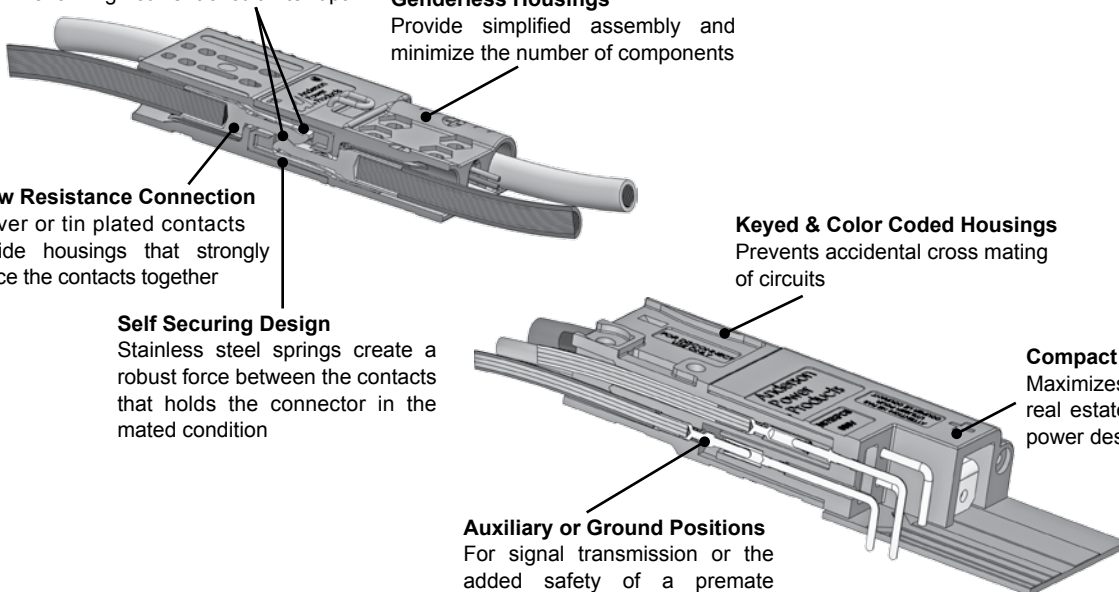

| MULTIPOLE FAMILY SELECTION GUIDE |

	SBS® Connector	SB® Connector	SBX® / SBE® / SBO® Connectors
Page Number	49	57	77
Amps Per Pole	50 - 110	50 - 450	60 - 350
Volts (UL) Per Pole	600	600	600
Wire Gauge (AWG)	16 - 6	16 - 300	16 - 300
Wire Gauge (mm²)	1.3 - 13.3	1.3 - 152	13.3 - 152
Number of Power Circuits	2 - 3	2 - 3	2
Number of Auxiliary Circuits	4	0	8
PCB Mount	•	•	
Bus Bar		•	
Panel Mount	•	•	
Hot Plug	•	•	•
Touch Safe	•		•
Mechanically Keyed	•	•	•
Handle	•	•	•
Air Supply System			•

Actual Size - Connector Half

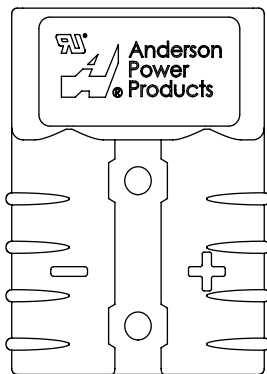

SB®50

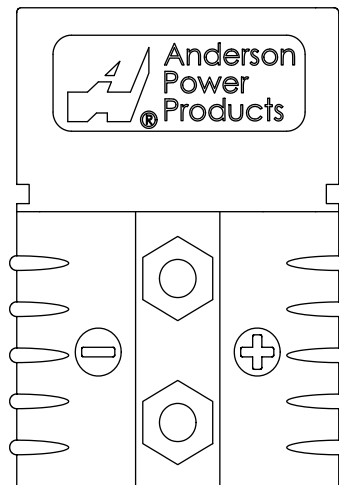

SB®120

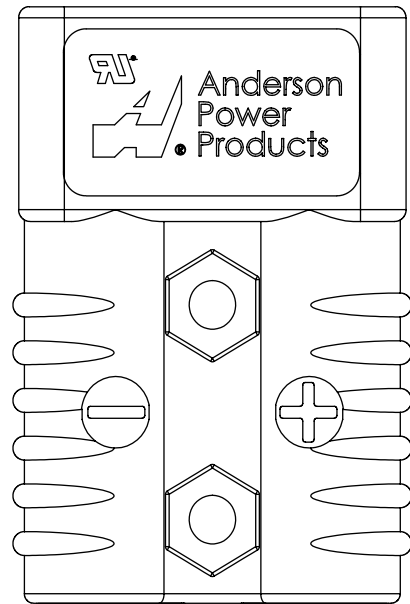

SB®175 - 2 Pole

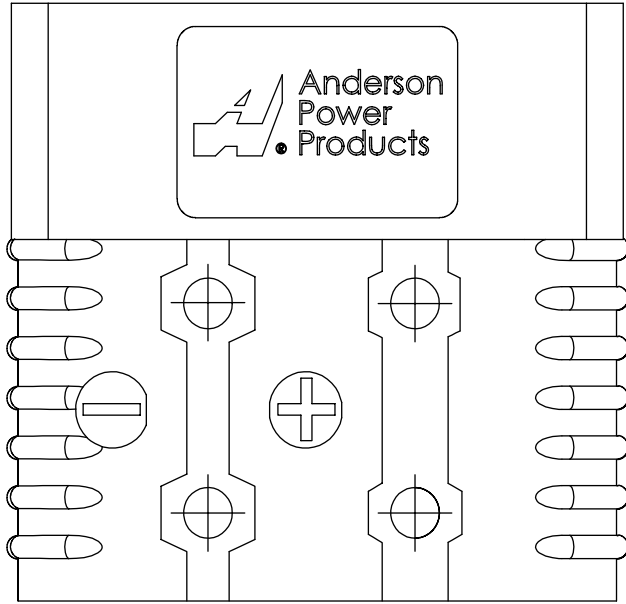

SB®175 - 3 Pole

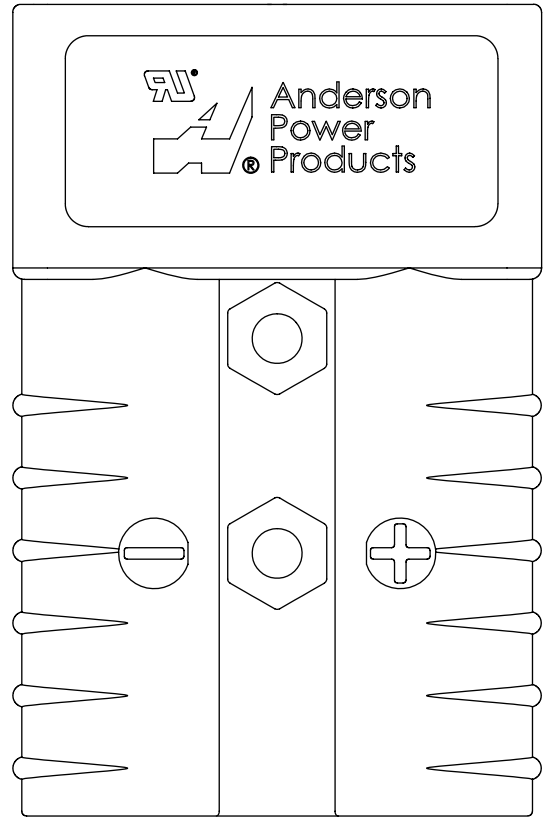

SB®350

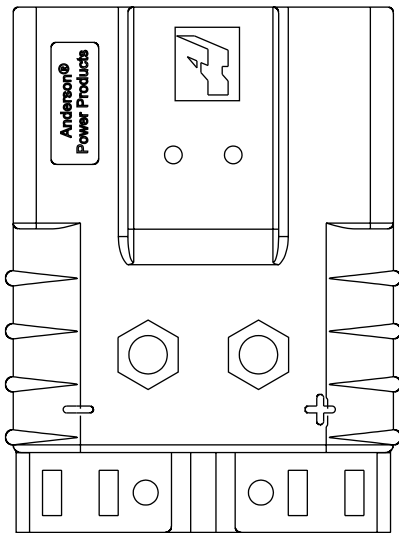

SBE®60 - SBO®80

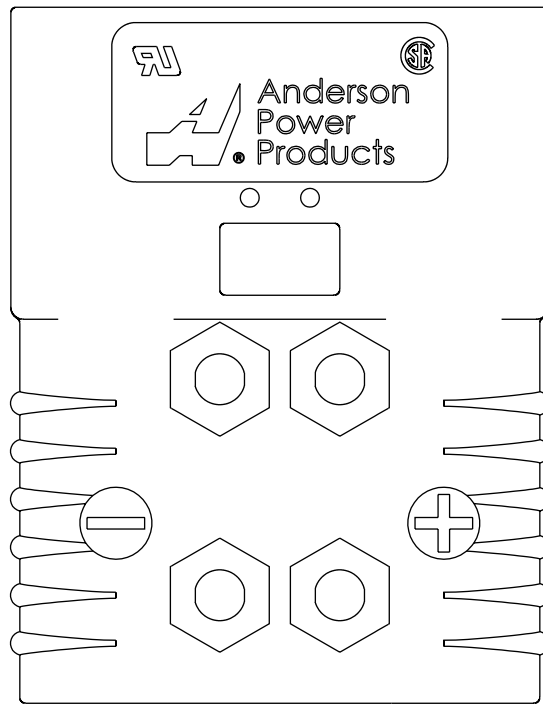

SBE®160 - SBX®175

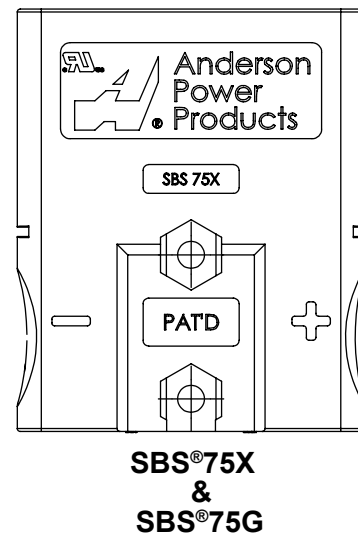
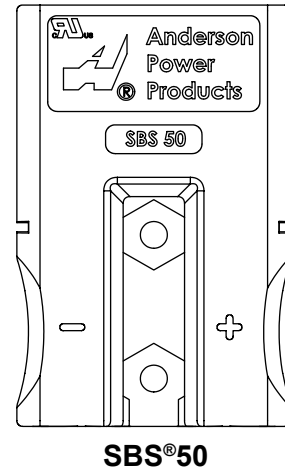
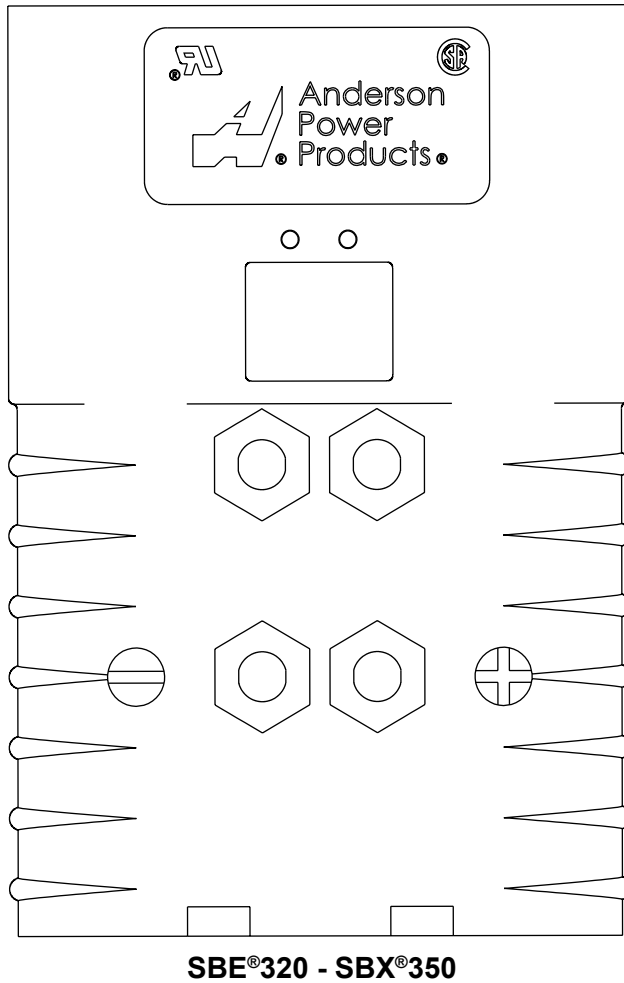

Explanation of Mechanical Voltage Keys

Features molded into the mating interface of the connector housing prevent accidental cross mating of circuits. This molded feature mechanically keys the connection so that only housings with the same mating interface can be mated together.

Different mechanical keys can be easily recognized by the color of the housing. This color coding corresponds to a voltage that industrial trucks, batteries, and chargers have adopted as a standard to prevent incompatible voltages from cross mating.

The same mechanical keying and color coding that is so successful for industrial trucks, is also widely used in power electronics applications. UPS systems, power supplies, personal mobility, and alternative energy applications have all used this feature to ensure user safety.

Note: Some housings in the SB®50, SB®175, and SB®350 series have different colored housings with a shared mechanical keying feature. Please see the specific data sheet for details.

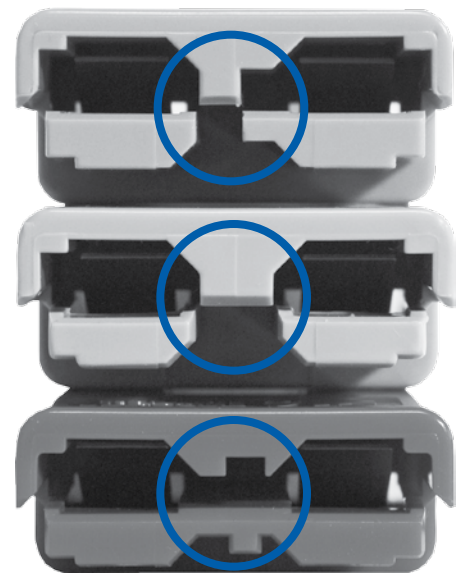

| Scratch Pad |

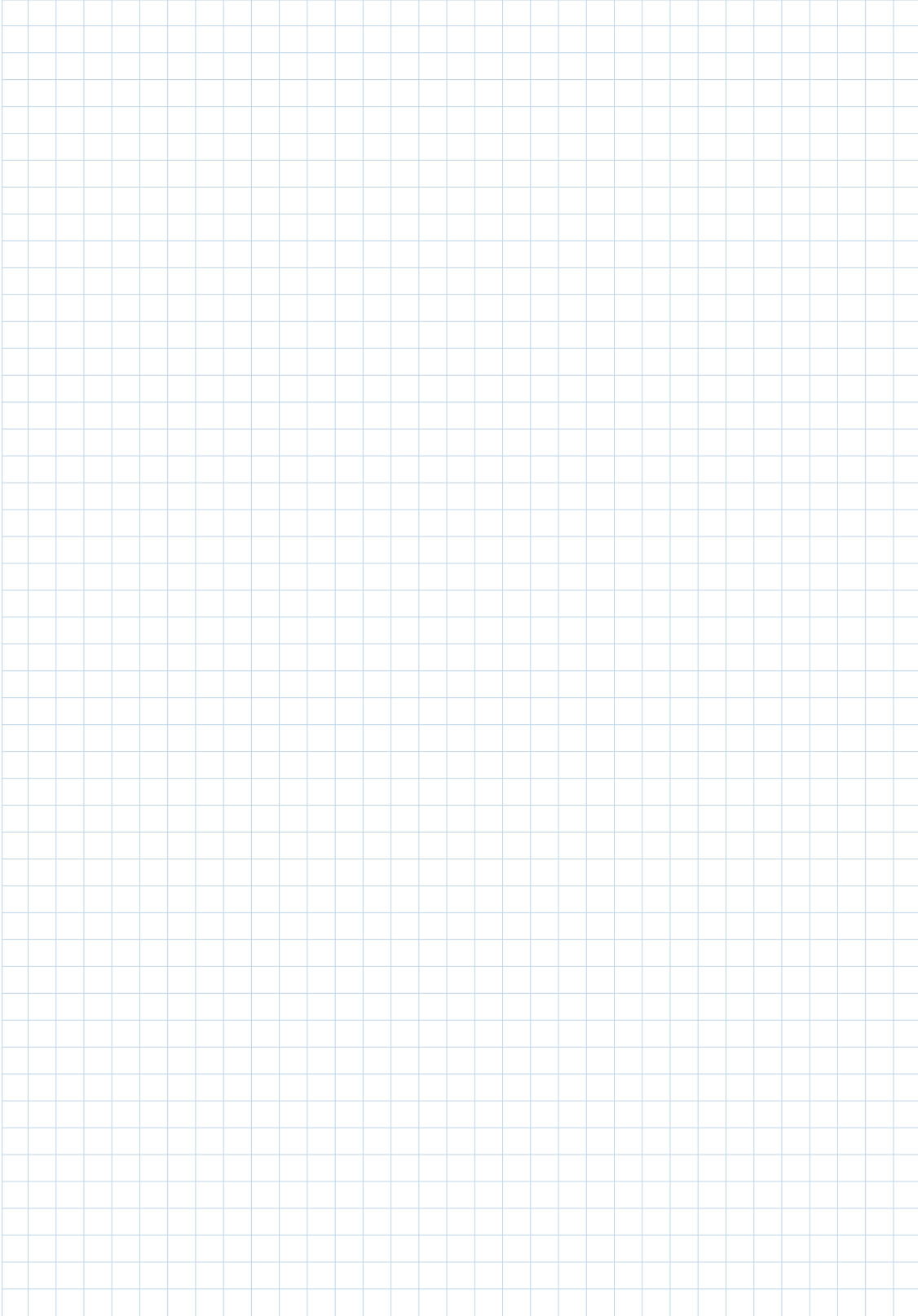

SBS® Connectors - up to 105 amps

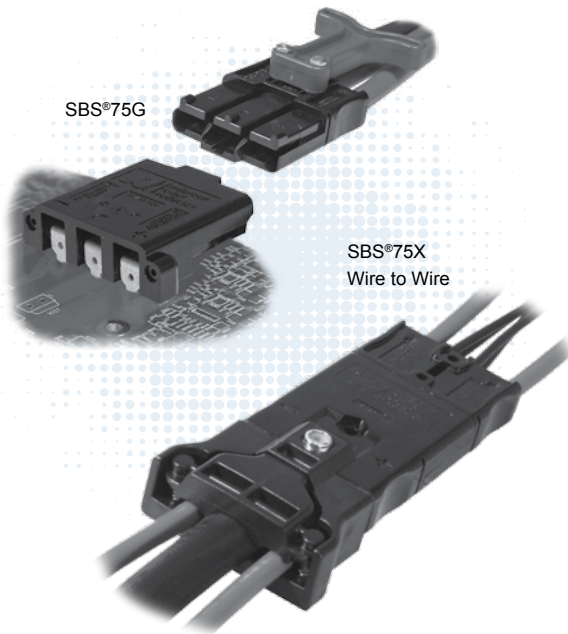

The patented SBS® connector family is designed to provide high power in a compact ergonomic housing with protection against accidental contact with live circuits. This is of particular importance in applications where DC voltages exceed 30 volts and can be health threatening.

Wire-to-wire and wire-to-board configurations both provide power contacts rated up to 105 amps. The SBS®75X offers up to 4 mate-last break-first auxiliary power contacts rated up to 20 amps. The SBS®75G features a third first-mate last-break ground or power contact. All contact positions are rated for circuit interruption (hot plugging).

- **Touch Safe Interface**
 - Can safely be used in through panel applications
 - Minimizes potential contact with live circuits per IEC 60950
- **Wire-to-Wire and Wire-to-Board Configurations**
 - Allows one connector to meet multiple needs
- **Ground or Auxiliary Contacts Integrated into the One Piece Housing**
 - Meets all connection requirements in one compact connector housing

SBS® ORDERING INFORMATION |

SBS®50 Standard Housings

Polycarbonate housings feature 2 positions all finger proof. Genderless design mates with itself. Mechanical keys are color coded.

Description	Voltage Code	Part Numbers	
		500	50
Red	24V	SBS50RED-BK	SBS50RED
Gray	36V	SBS50GRA-BK	SBS50GRA
Blue	48V	SBS50BLU-BK	SBS50BLU
Green	72V	SBS50GRN-BK	SBS50GRN
Black	80V	SBS50BLK-BK	SBS50BLK
Brown	96V	SBS50BRN-BK	SBS50BRN
White	192V	SBS50WHT-BK	SBS50WHT

SBS®50 Chemical Resistant (CR) Housings

Same features as the standard housings, but molded out of a chemical resistant PBT/ PC blend. Suitable for use to -40°C.

Description	Voltage Code	Part Numbers	
		500	50
Red	24V	PSBS50RED-BK	PSBS50RED
Gray	36V	PSBS50GRA-BK	PSBS50GRA
Blue	48V	PSBS50BLU-BK	PSBS50BLU
Green	72V	PSBS50GRN-BK	PSBS50GRN
Black	80V	PSBS50BLK-BK	PSBS50BLK
Brown	96V	PSBS50BRN-BK	PSBS50BRN

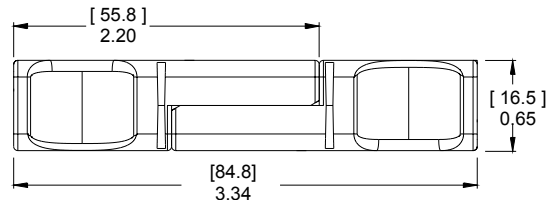
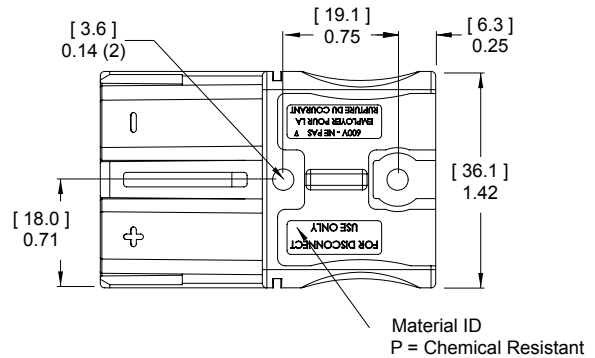

SBS®75X Standard Housings

Polycarbonate housings feature 4 auxiliary and 2 primary positions all finger proof. Genderless design mates with itself, or the PCB connector. Mechanical keys are color coded.

Description	Voltage	Color	Code	----- Part Numbers -----
Minimum Quantity	250	50
Black	80V	SBS75XBLK-BK	SBS75XBLK	
Brown	96V	SBS75XBRN-BK	SBS75XBRN	

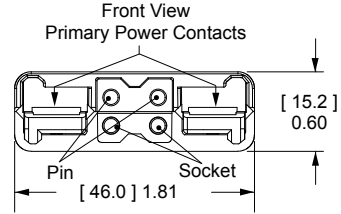

SBS®75X Chemical Resistant (CR) Housings

Same features as the standard housings, but molded out of a chemical resistant PBT/ PC blend. Suitable for use to -40°C.

Description	Voltage	Color	Code	----- Part Numbers -----
Minimum Quantity	250	50
Green	72V	PSBS75XGRN-BK	PSBS75XGRN	
Black	80V	PSBS75XBLK-BK	PSBS75XBLK	

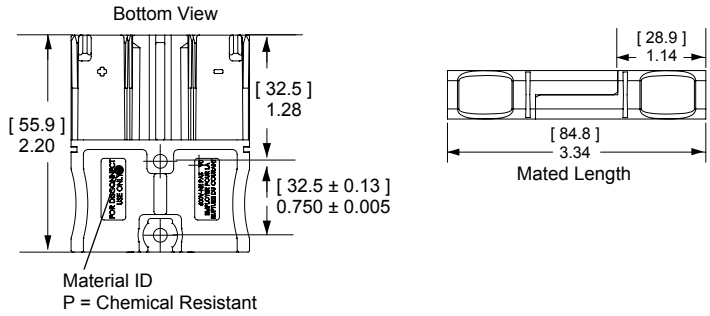

SBS®75X Assembled PCB Connector

Fully assembled PCB connector is designed to mate with SBS®75X Wire connector. All positions are preloaded with contacts including standard mating length auxiliary positions. Press fit board locks help secure the connector to the PCB before and after soldering.

Description	Voltage	Color	Code	----- Part Numbers -----
Minimum Quantity	100	50
Black	80V	SBS75XPRBLK-BK	SBS75XPRBLK	

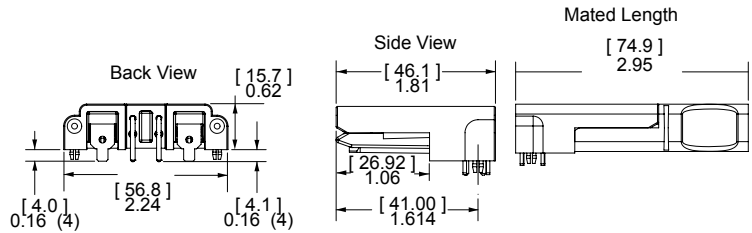

See PCB connector drawing on website for further detail.

SBS®75G Wire Housings

Polycarbonate housings feature three finger proof positions. The center position can be used for pre-mate power or ground. Genderless design mates with itself, or the PCB connector. Mechanical keys are color coded. Inquire with customer service for chemical resistant housings.

Description	Voltage	Color	Code	----- Part Numbers -----
Minimum Quantity	250	50
Gray	36V	SBS75GGRA-BK	SBS75GGRA	
Blue	48V	SBS75GBLU-BK	SBS75GBLU	
Black	80V	SBS75GBLK-BK	SBS75GBLK	
Brown	96V	SBS75GBRN-BK	SBS75GBRN	

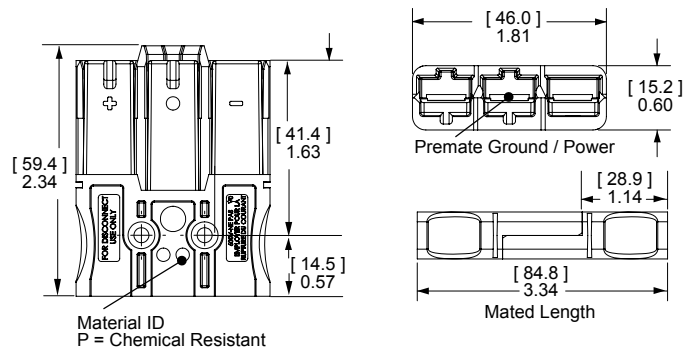

SBS®75G Assembled PCB Connector

Fully assembled PCB connector is designed to mate with SBS®75G Wire connector. Has press fit board locks to help secure the connector to the PCB before and after soldering.

Description	Voltage	Color	Code	----- Part Numbers -----
Minimum Quantity	100	50
Black	80V	SBS75GPRBLK-BK	SBS75GPRBLK	

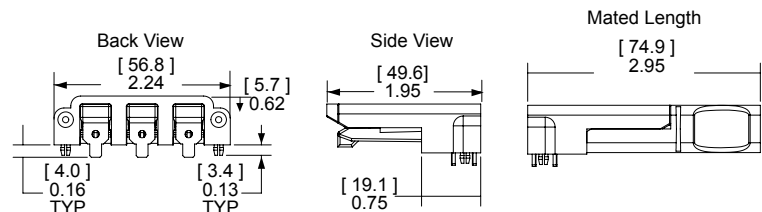

See PCB connector drawing on website for further detail.

SBS® Silver Plated Primary Power Wire Contacts

Use two silver plated contacts per housing for the best electrical performance and durability up to 10,000 mating cycles. Standard contacts are for use in all primary power positions for SBS® 50, 75X, & 75G wire housings.

Type	AWG	mm ²	Loose Piece		Dimensions - A -	
			Part Numbers	Part Numbers	inches	mm
Minimum Quantity			1,000	100		
Standard	6	16	1339G2-BK	1339G2	0.22	5.59
Standard	8	10	1339G5-BK	1339G5	0.19	4.83
Standard	12 to 10	4 to 6	1339G3-BK	1339G3	0.14	3.56

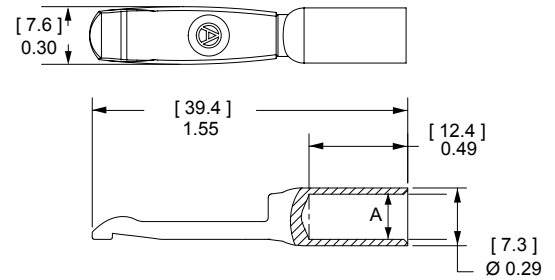

SBS®75G Silver Plated Pre-Mate Wire Contacts

Pre-Mate contacts are for the center Pre-Mate position on the SBS®75G wire housings.

Type	AWG	mm ²	Loose Piece		Dimensions - A -	
			Part Numbers	Part Numbers	inches	mm
Minimum Quantity			500	50		
Pre-Mate	6	16	1340G1-BK	1340G1	0.22	5.59
Pre-Mate	8	10	1340G2-BK	1340G2	0.19	4.83
Pre-Mate	12 to 10	4 to 6	1340G3-BK	1340G3	0.14	3.56

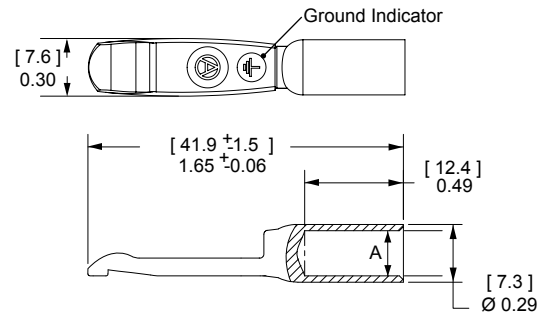

Pin Contacts for 1x4 Auxiliary Connector

Gold plated contacts are available in 4 lengths to allow sequencing of circuits.

Description	AWG	mm ²	Part Numbers	
			500	50
Minimum Quantity			500	50
Standard Length 7.7mm	12	2.5	PM16P12S30	PM16P12S30-50
	16 to 14	1.0 to 1.5	PM16P1416S30	PM16P1416S30-50
	20 to 16	0.75 to 1.0	PM16P1620S30	PM16P1620S30-50
	24 to 20	0.50 to 0.75	PM16P2024S30	PM16P2024S30-50
Pre-Mate 9.3mm	12	2.5	PM16P12A30	PM16P12A30-50
	16 to 14	1.0 to 1.5	PM16P1416A30	PM16P1416A30-50
	20 to 16	0.75 to 1.0	PM16P1620A30	PM16P1620A30-50
	24 to 20	0.50 to 0.75	PM16P2024A30	PM16P2024A30-50
Pre-Mate 8.5mm	12	2.5	PM16P12B30	PM16P12B30-50
	16 to 14	1.0 to 1.5	PM16P1416B30	PM16P1416B30-50
	20 to 16	0.75 to 1.0	PM16P1620B30	PM16P1620B30-50
	24 to 20	0.50 to 0.75	PM16P2024B30	PM16P2024B30-50
Post-Mate 6.4mm	12	2.5	PM16P12C30	PM16P12C30-50
	16 to 14	1.0 to 1.5	PM16P1416C30	PM16P1416C30-50
	20 to 16	0.75 to 1.0	PM16P1620C30	PM16P1620C30-50
	24 to 20	0.50 to 0.75	PM16P2024C30	PM16P2024C30-50

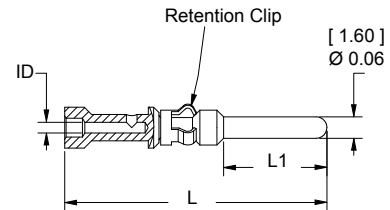

Auxiliary Pin Contact Lengths	- L -		- L1 -	
	in.	mm	in.	mm
Standard Length 7.7mm	0.77	19.6	0.30	7.7
Pre-Mate 9.3mm	0.83	21.2	0.37	9.3
Pre-mate 8.5mm	0.80	20.4	0.33	8.5
Post-Mate 6.6mm	0.72	18.3	0.25	6.4

Socket Contacts for 1x4 Auxiliary Connector

Selectively gold plated contacts offer low resistance and durability up to 10,000 mating cycles.

Description	AWG	mm ²	Part Numbers	
			500	50
Minimum Quantity			500	50
Socket Contact	12	2.5	PM16S12S32	PM16S12S32-50
	16 to 14	1.0 to 1.5	PM16S1416S32	PM16S1416S32-50
	20 to 16	0.75 to 1.0	PM16S1620S32	PM16S1620S32-50
	24 to 20	0.50 to 0.75	PM16S2024S32	PM16S2024S32-50

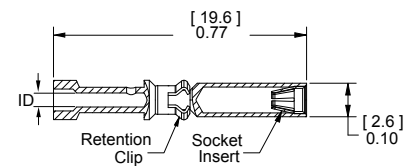

Auxiliary Socket Contacts Crimp Barrel ID		
Wire Gauge	in.	mm.
#24 / 20	0.04	1.1
#20 / 16	0.07	1.7
#16 / 14	0.08	2.1
#12	0.10	2.6

SBS® CONNECTOR SPECIFICATIONS

Electrical

Current Rating Amperes ¹	UL 1977	CSA/TUV
Primary Power (6 AWG)	110	75
Auxiliary (12 AWG)	20	10
Voltage Rating AC/DC		
UL 1977	600	
Dielectric Withstanding Voltage		
Volts AC	2,200	
Avg. Mated Contact Resistance Milliohms¹		
Power & Ground: 1 1/4" of #6 AWG wire	0.200	
Auxiliary: Wire & PCB	3.000	
UL Hot Plug Current Rating Amperes - 250 cycles at 120V DC		
Wire & PCB Power	50A	
Wire & PCB Auxiliary	5A	
UL Ground Short Time Current Test - SBS75G Wire & PCB		
1530 Amps, #6 AWG Wire	6 seconds	

Mechanical

Wire Size Range	AWG	mm ²	
Power Contacts	16 to 6	1.3 to 13.3	
Auxiliary Contacts	24 to 12	0.25 to 3.3	
Max. Wire Insulation Diameter			
	in.	mm	
SBS®75G Power & Ground	0.380	9.652	
SBS®50 & SBS®75X Power Contacts	0.410	10.414	
SBS®75X Auxiliary Contacts	0.140	3.600	
Operating Temperature²			
	°F	°C	
Standard	-4° to 221°	-20° to 105°	
Chemical Resistant	-40 to 221°	-40° to 105°	
Mating Cycles No Load by Plating			
	Silver (Ag)	Tin (Sn)	Gold (Au)
Power & Ground Contacts Wire	10,000		
Power & Ground Contacts PCB		1,500	
Auxiliary Contacts			10,000
Avg. Mating / Unmating Force			
	Lbf.	N	
SBS®75X and SBS®75G Wire to Wire	16	70	
SBS®50 Wire to Wire	8	36	
SBS®75X and SBS®75G Wire to PCB	8	36	
Min. Contact / Spring Retention Force			
	Lbf.	N	
Power, Standard Housing	50	222	
Power, Chem. Resistant Housing	30	133	
Aux. Standard Housing	15	67	
Aux. Chem. Resistant Housing	10	44	
PCB Specifications			
Mounting Style	Plated Through Hole		
Max PCB Thickness- in. [mm]	0.093 [2.4]		
Recommended Traces Power & Ground	#6 AWG Cross Section		
Recommended Traces Auxiliary	#12 AWG Cross Section		
Min. Creepage / Clearance Distance PCB			
	in.	mm	
Power to Aux. Creepage SBS®75X	0.41	10.4	
Power to Aux. Clearance SBS®75X	0.24	6.1	
Power to Ground Creepage SBS®75G	0.35	8.9	
Power to Ground Clearance SBS®75G	0.26	6.7	
Auxiliary Creepage SBS®75X	0.12	3.0	
Auxiliary Clearance SBS®75X	0.12	3.0	

Materials

Housing	
Standard Plastic Resin	Polycarbonate
Chem. Resistant Resin	Polycarbonate / PBT blend
Contact Retention Spring	Stainless Steel
Housing Flammability Rating	
UL94	V-0
Wire Power & Ground Contact	Silver Plated Copper Alloy
PCB Power & Ground Contact	Tin Plated Copper Alloy
SBS75X Auxiliary Contacts	
Pin	Copper alloy, Au over Ni
Socket	BeCu, Au over Ni
Socket Body	Copper alloy, Sn bright over Ni
Retention Clip	Stainless Steel
PCB Press Fit Retainers	Brass - Tin Plated
Contact Termination Methods	
Crimp ³	Wire Contacts
Hand Solder	Wire and PCB Contacts
Solder Dip	PCB Contacts
Wave Solder	PCB Contacts

Protection

Touch Safety with Wire Contacts & PCB Mating Interface	
IEC 60950	Pass
IEC 60529	IP20

Auxiliary contacts are available for SBS®75X only.

SBS®75X and SBS®75G PCB connectors are designed to mate only with the wire connector of the same series.

¹ Based on: 105°C rated or better cable of the largest size, Properly calibrated APP® recommended tooling, and a 25°C ambient temperature. UL rating not to exceed the maximum operating temperature. CSA rating below a 30°C temperature rise.

² Limited by the thermal properties of the connector plastic housing.

³ Use APP® recommended tooling only. Alternate tools may adversely affect the performance of our connectors along with UL and CSA recognition.



| SBS® CONNECTOR TEMPERATURE CHARTS |

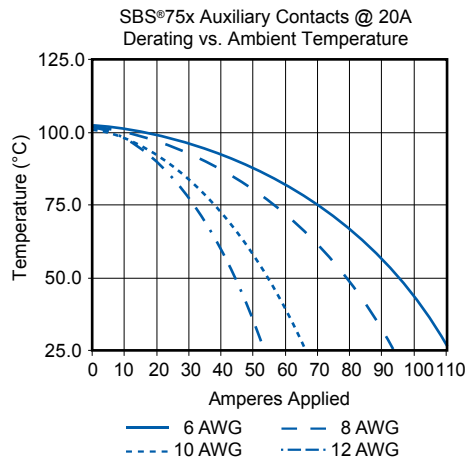
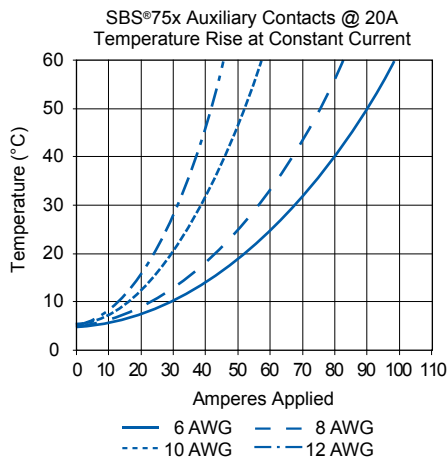
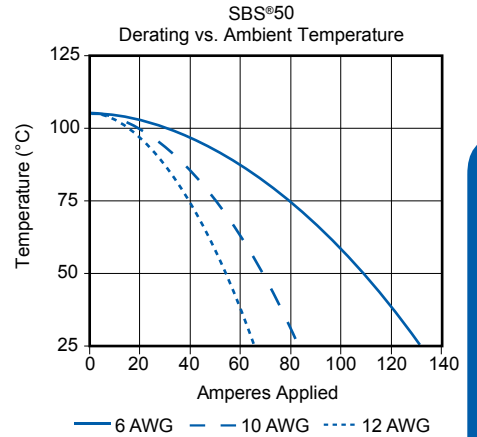
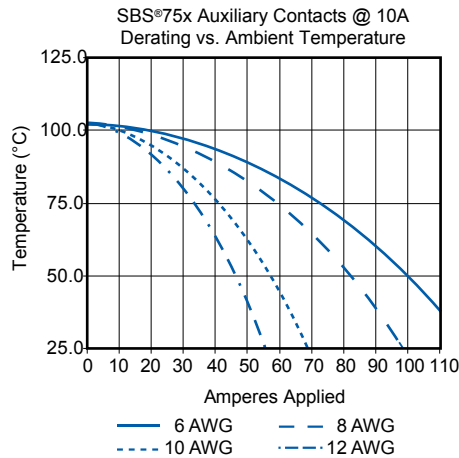
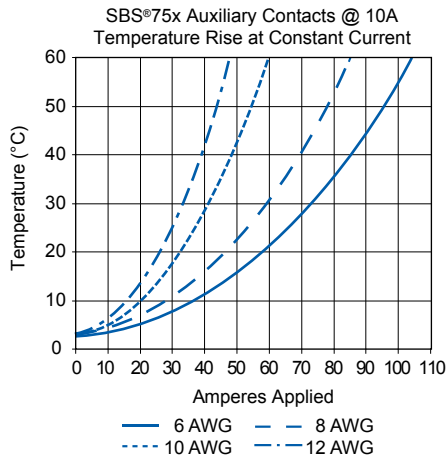
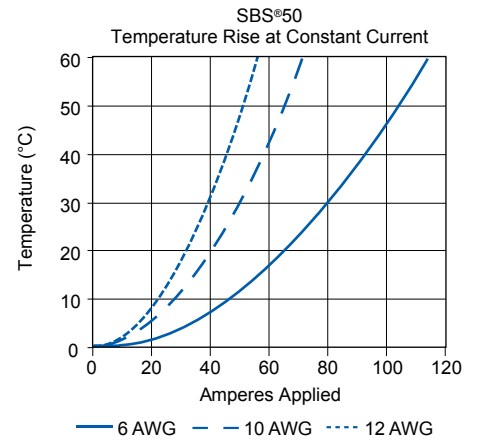
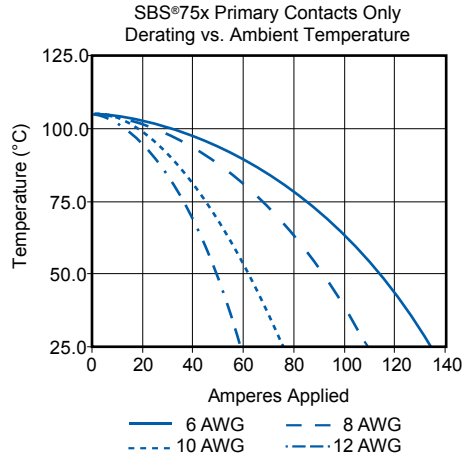
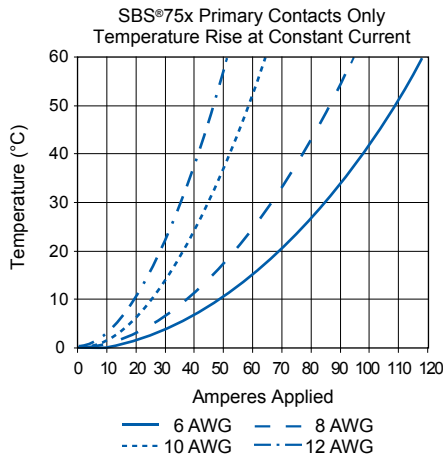

NOTE: Temperature rise charts are based on a 25°C ambient temperature.

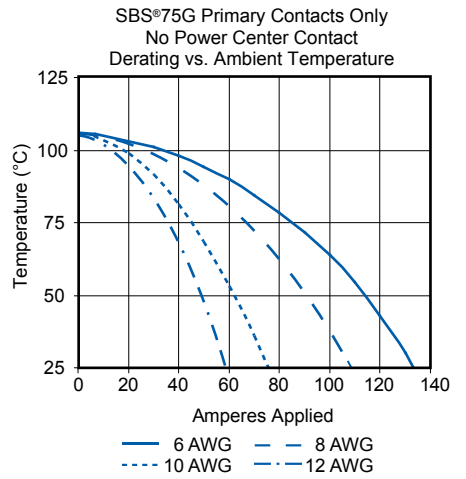
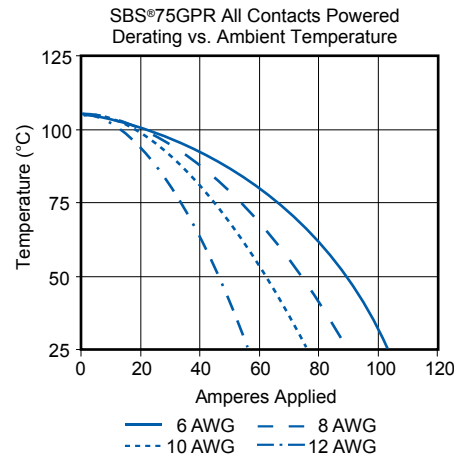
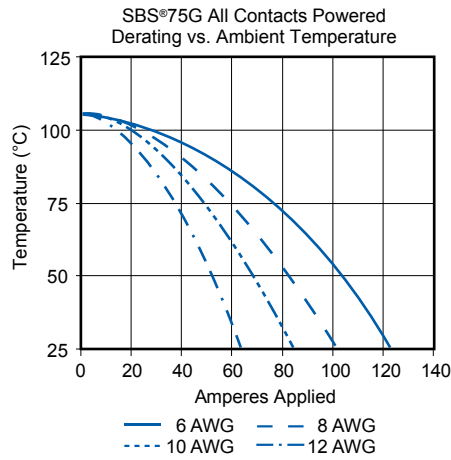
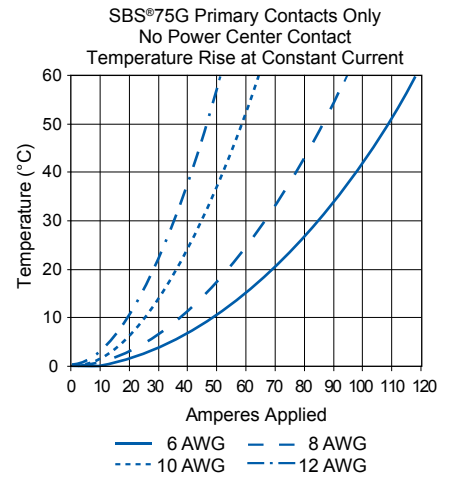
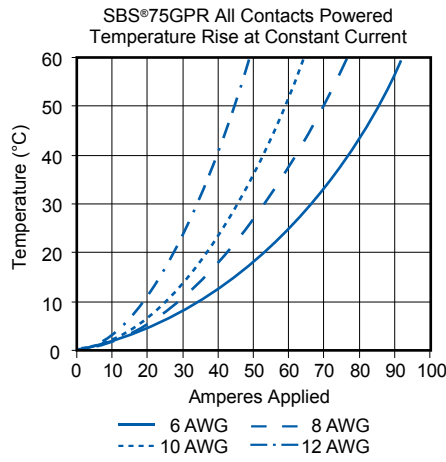
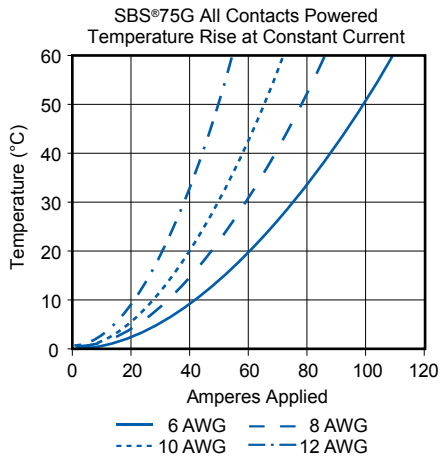

NOTE: Temperature rise charts are based on 25 °C ambient temperature.

SBS® Accessories |

Mounting Clamp for SBS®50

Mounting clamps can be used for fastening a SBS®50 series housings to a panel. Fastening hardware not included.

Description	--- Part Number ---
Minimum Quantity	20 sets of 2
Panel Mount Bracket for SBS®50	1466G1

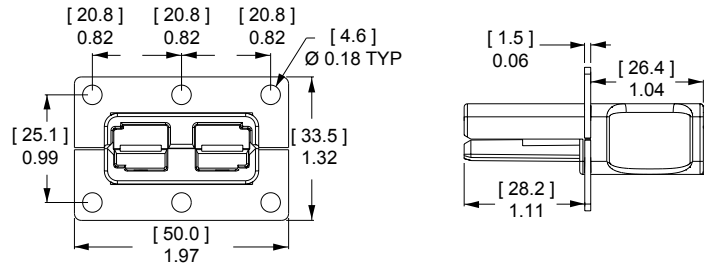

T-Handle for SBS®50 and SBS®75X

The "T" handle makes mating and unmating the connector easier. The non-conductive red plastic material is strong and safe. (2) Self tapping screws are used to secure the handle to the connector housing.

Description	----- Part Numbers -----	
Minimum Quantity	1,000	50
Red "T" Handle + Hardware Bag	-	SBS50-HDL-RED
Hardware Bag (2 Screws)	-	104G17
Red "T" Handle Only	H13899P1	-
#8 x 5/8" Screw (Order 2 Per Handle)	H1120P41	-

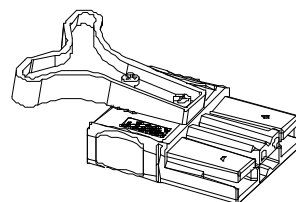

T-Handle for SBS®75G

The "T" handle makes mating and unmating the connector easier. The non-conductive red plastic material is strong and safe. (2) Machine screws and lock nuts.

Description	--- Part Number ---
Minimum Quantity	50
Red "T" Handle + Hardware Bag	SBS75GHDL-RED

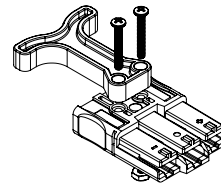

Dust Cover SBS®50

Prevents dust and dirt from entering the mating interface of the connector when unmated. NOTE: Not a Hermetic Seal.

Description	---- Part Number ----
Minimum Quantity	500 50 ...
Dust Cover with Lanyard Strap, Red	113890P1 134G1

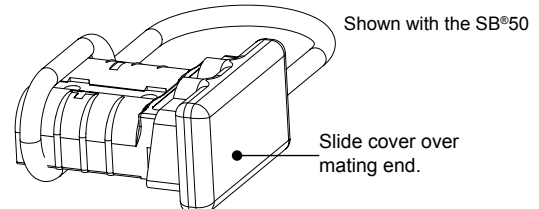

Cable Clamps for SBS®50

Durable metal cable clamps securely hold cables to prevent accidental strain or pulls from dislodging wire or contacts from the housing. Cable clamps are recommended for solder terminated wires.

Description	Cable Size		----- Part Numbers -----	
	AWG or (Inches O.D.)	mm ² or (mm O.D.)		
Minimum Quantity			500	50 ...
Self Attaching for Discrete Conductor	8 to 6	10	990-BK	990
Self Attaching for Discrete Conductor	12 to 10	4 to 6	990G2-BK	990G2
Bolt On for Discrete Conductor	12 to 6	4 to 10	990G1-BK	990G1
Bolt On for Bundled Conductor	(0.320 to 0.450)	(4.27 to 11.43)	5905-BK	5905

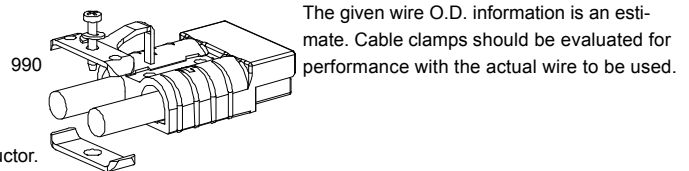
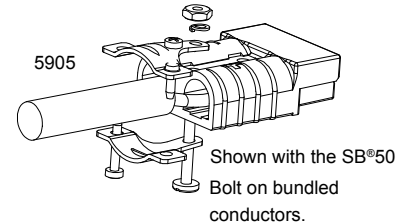

Self attaching discrete conductor.

The given wire O.D. information is an estimate. Cable clamps should be evaluated for performance with the actual wire to be used.

Cable Clamps for SBS®75X with Integral Handle

Rugged chemical resistant PBT/ PC plastic cable clamps securely hold cables to prevent accidental strain or pulls from dislodging wire or contacts from the housing. Cable clamps are recommended for solder terminated wires.

Description	Cable Size AWG or (Inches O.D.)	mm ² or (mm O.D.)	----- Part Numbers -----	
Minimum Quantity			100	25
Large Wire Clamp Kit w/ Hardware	12 to 6 (0.39 to 0.60)	4 to 10 (9.9 to 15.2)	SBS75XCLP1-BK	SBS75XCLP1
Small Wire Clamp Kit w/ Hardware	12 to 6 (0.34 to 0.55)	4 to 10 (8.6 to 14.0)	SBS75XCLP2-BK	SBS75XCLP2

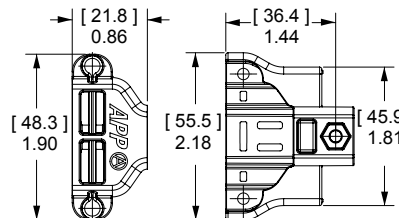

The given wire O.D. information is an estimate. Cable clamps should be evaluated for performance with the actual wire to be used.

Clamp hardware requires phillips or flat blade screwdriver to assemble.

Reducing Bushings

Use with contact part number 1339G2-BK or 1340G1-BK to allow a smaller wire to be used with the connector. Electrical capability is derated with smaller wire.

Contact Barrel Size	Wire Size	----- Part Numbers -----			Dimensions			
					- ID - inches	mm	- Length - inches	mm
Minimum Quantity		3,000	1,000	100				
#6 AWG [13.3 mm ²]	#8 AWG [8.4 mm ²]	-	5912-BK	5912	0.18	4.57	0.45	11.43
#6 AWG [13.3 mm ²]	#12- 10 AWG [3.3- 5.3 mm ²]	5910-BK	-	5910	0.14	3.56	0.47	11.94
#6 AWG [13.3 mm ²]	#16- 14 AWG [1.3- 2.1 mm ²]	5913-BK	-	5913	0.09	2.29	0.47	11.94

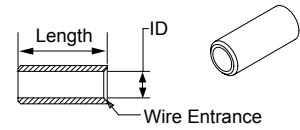

SBS® - Tooling Information

Wire Size		Power Contact Part Number	Pneumatic Bench Tool	+ Die	+ Locator	Number of Crimps	Hand Tool
AWG	mm ²						
#6	13.3	1339G2	1387G1	1388G6	1389G9	Single	1309G4
#8	8.4	1339G5		1388G7			
#10 / 12	5.3 / 3.3	1339G3		1388G6	1389G20		
#6	13.3	1340G1					
#8	8.4	1340G2					
#10 / 12	5.3 / 3.3	1340G3					

Wire Size		Auxiliary Contact Part Number	APP Hand Tool w/ Integral Locator	Mil Std. Hand Tool* M22520/1-01	Pneumatic Tool*	Number of Crimps	Locator for: TM0001 & TP0001
AWG	mm ²						
#12 / 24	2.5 / 0.25	All Crimp Pins	PM1000G1	O R TM0001	O R TP0001	Single	+ TL0001 TL0002
		All Crimp Sockets					

* TP0001 and TM0001 tools require locators TL0001 for Pins and TL0002 for Sockets.
NOTE: See website for the most current information.

SB® 50 Connectors - up to 120 amps

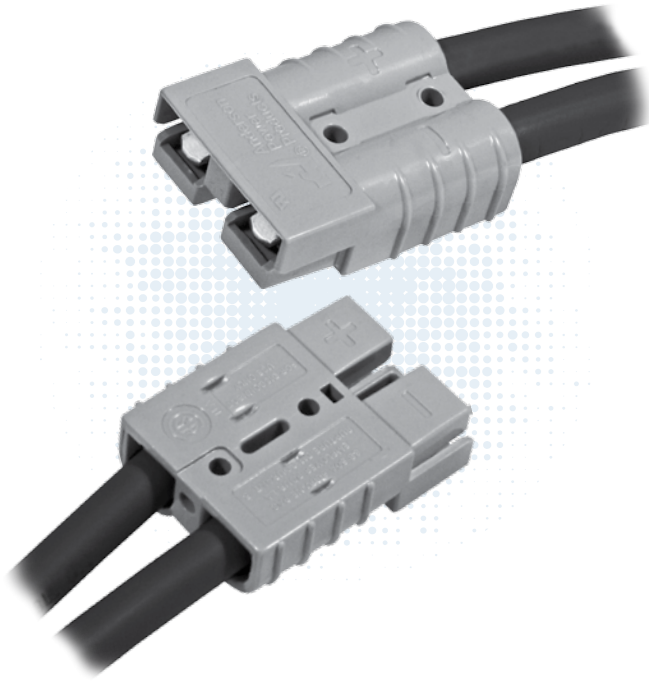

Based off the design pioneered by Anderson in 1953, APP's two pole SB® connectors set the standard for DC power distribution and battery connections. SB®50 connectors feature a one piece plastic housing using stainless steel springs to hold low resistance contacts in place. Wires sizes from #16 (1.5 mm²) to #6 (13.3 mm²) are held in the smallest of the SB® series housings.

- **Low Resistance Silver or Tin Plated Copper Contacts**
Allows UL rated currents up to 120 amps
- **UL Rated for Hot Plugging up to 50 Amps**
Great for battery or other applications where the ability to interrupt circuits is required
- **Wire, PCB, and Busbar Contacts**
Allows one connection system to meet multiple needs

| SB50® ORDERING INFORMATION |

SB®50 Standard Housings

The smallest SB® housings work with wire contacts up to 6 AWG [10 mm²] as well as PCB, and busbar contacts. Genderless design mates with itself. Mechanical keys are color coded.

Description	Voltage Color Code	Part Numbers
Minimum Quantity	500	100 ...
Yellow	12V	992G5-BK 992G5
Orange	18V	992G7-BK 992G7
Red	24V	992G1-BK 992G1
Gray	36V	992-BK 992
Blue	48V	992G4-BK 992G4
Green	72V	992G6-BK 992G6
Black	80V	992G2-BK 992G2

NOTE: SB®50 Black and Gray housings have the same keying features and can be intermated.

SB®50 Chemical Resistant Housings

Same features as the Standard SB®50 but molded in a chemical resistant PBT/ PC blend. Suitable for use to -40°C.

Description	Voltage Color Code	Part Numbers
Minimum Quantity	500	100 ...
Red	24V	P992G1-BK P992G1
Gray	36V	P992-BK P992
Black	80V	P992G2-BK P992G2

NOTE: SB®50 Black and Gray housings have the same keying features and can be intermated.

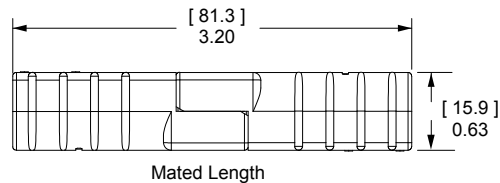
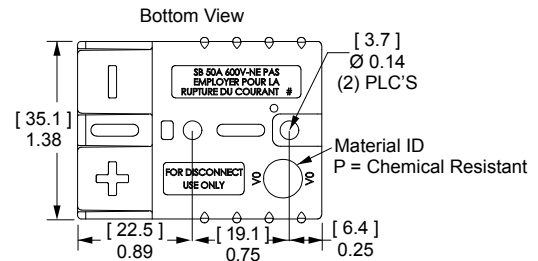

SB®50 Silver Plated Wire Contacts

Use two silver plated contacts per housing for the best electrical performance and durability up to 10,000 mating cycles.

AWG	mm ²	Mating Force	Loose Piece Part Numbers		Dimensions - A -	
			1,000	100	inches	mm
Minimum Quantity						
6	13.3	Low	1307-BK	1307	0.22	5.59
6	13.3	High	5900-BK	5900	0.22	5.59
8	8.4	High	5952-Bk	5952	0.19	4.83
12 to 10	3.3 to 5.3	Low	5953-BK	5953	0.14	3.56
12 to 10	3.3 to 5.3	High	5915-BK	5915	0.14	3.56

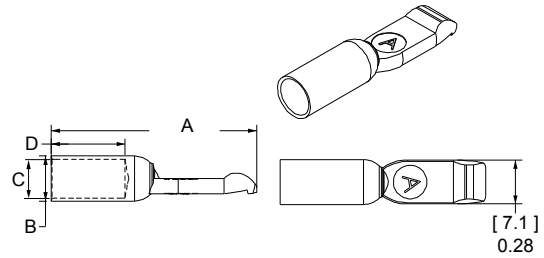

SB®50 Tin Plated Reeled Wire Contacts

Use two reeled contacts per housing. Reeled contacts are for use with the recommended high volume press and applicator tooling. Rated for up to 1,500 mating cycles.

AWG	mm ²	Mating Force	Reeled Part Numbers	Dimensions				
				- A -		- B -		
				inches	mm	inches	mm	
Minimum Quantity							2,000	
8 to 6	8.4 to 13.3	High	265G5	0.26	6.60	0.36	9.14	
12 to 10	3.3 to 5.3	High	265G6	0.17	4.32	0.29	7.37	

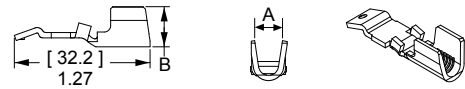

SB®50 Silver Plated Busbar Contacts

Use 2 busbar contacts per housing to provide a quick disconnect input or output busbar connection. Busbar contacts are for mating with wire contacts only. Part number 75BBS includes lock nuts. Locknuts must be ordered separately for B01956P4.

Type	Thread	Mating Force	Loose Piece Part Numbers			
			1,000	120	20	10
Minimum Quantity						
Busbar	#10-24	High	-	B01956P4	-	75BBS
Lock Nut	#10-24	-	H1216P8	-	110G54	-

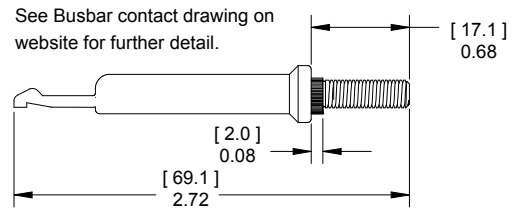

55A Right Angle Standard Powerlaw PCB Contacts

Standard Powerlaw contacts are for use inside a SB®50 housing and provide a color coded right angle connection to the PCB.

Description	- Loose Piece Part Numbers -	
Minimum Quantity	500	100
Tin Plated	PC5930T-BK	PC5930T
Silver Plated	PC5930S-BK	PC5930S

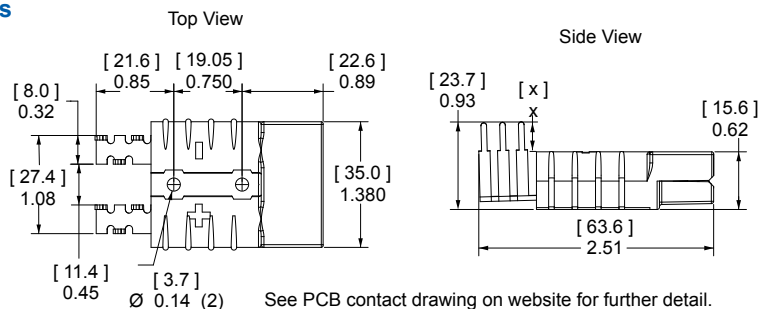

55A Right Angle Mini Powerlaw PCB Contacts

Right angle Mini Powerlaw contacts can be used on the PCB edge without a SB®50 housing on the PCB side. A self polarizing design only allow SB®50 wire housings to mate to PCB contacts one way.

Description	- Loose Piece Part Numbers -	
Minimum Quantity	1,000	100
Tin Plated	PC5934T-BK	PC5934T
Silver Plated	PC5934S-BK	PC5934S

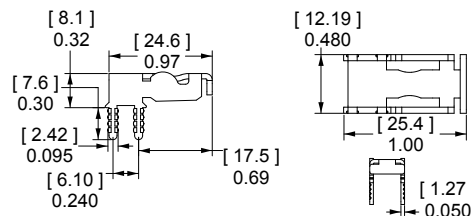

55A Vertical Mini Powerclaw PCB Contacts

Vertical Mini Powerclaw contacts save space by not requiring a SB®50 housing on the PCB side. The guide housing is required for to provide a polarized connection. (See SB®50 accessories).

Description	- Loose Piece Part Numbers -	
Minimum Quantity	1,500	100
Tin Plated	PC5933T-BK	PC5933T
Silver Plated	PC5933S-BK	PC5933S

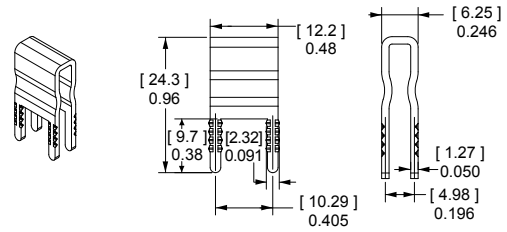

| SB®50 CONNECTOR SPECIFICATIONS |

Electrical		
Current Rating Amperes¹	UL 1977	CSA
Wire to Wire UL 1977 (6 AWG)	120	50
Wire to PCB UL 1977 (6 AWG)	50	
Voltage Rating AC/DC		
UL 1977	600	
PCB Connector Recommended Voltage per IEC 60950-1 Table 2L Pollution Degree²		
Mini Vert. Contact	522	
Mini Horiz. Contact	504	
Standard Contact	950	
Dielectric Withstanding Voltage		
Volts AC	2,200	
Avg. Mated Contact Resistance Milliohms¹		
1 1/4" of #6 AWG wire	0.200	
PCB Contact to Contact	0.500	
UL Hot Plug Current Rating Amperes - 250 cycles at 120V DC		
Wire- wire	50A	
PCB- wire	40A	
(Vertical Mini Powerclaw)		

Materials	
Housing	
Standard Plastic Resin	Polycarbonate
Chem. Resistant Resin	Polycarbonate / PBT blend
Contact Retention Spring	Stainless Steel
Housing Flammability Rating	
UL94	V-0
Contact	
Base	Copper Alloy
Wire Plating	Silver
PCB Plating	Sn or Ag over Ni
Contact Termination Methods	
Crimp ³	Wire Contacts
Hand Solder	Wire and PCB Contacts
Solder Dip*	PCB Contacts
Wave Solder*	PCB Contacts
Wrench / Socket	Busbar Contacts

Mechanical		
Wire Size Range	AWG	mm²
	16 to 6	1.3 to 13.3
Max. Wire Insulation Diameter	in.	mm
	0.440	11.200
Operating Temperature²	°F	°C
Standard	-4° to 221°	-20° to 105°
Chemical Resistant*	-40 to 221°	-40° to 105°
*Chemical resistant material not available for PCB guide housings		
Mating Cycles No Load by Plating	Silver (Ag)	Tin (Sn)
Wire and PCB Contacts	10,000	1,500
Avg. Mating / Unmating Force	Lbf.	N
Wire to Wire Low Force Contacts	10	44
Wire to Wire High Force Contacts	15	67
Standard Powerclaw to Wire	15	66
Mini Powerclaw to Wire	8	36
PCB Specifications		
Mounting Style	Plated Through Hole	
Max PCB Thickness- in. [mm]	Standard: 0.15 [0.381] Mini: 0.25 [0.635]	
Recommended Traces	#8 AWG Cross Section	
Min. Contact / Spring Retention Force	Lbf.	N
Wire Housing	50	222
Min. Creepage / [Clearance] Distance	in.	mm
Standard Powerclaw	0.374	9.5
Mini Vert. Powerclaw	0.213	5.4
Mini Horiz. Powerclaw	0.205	5.2

Protection	
Touch Safety with Wire Contacts	
IEC 60529	IP10

¹ Based on: 105°C rated or better cable of the largest size, Properly calibrated APP® recommended tooling, and a 25°C ambient temperature. UL rating not to exceed the maximum operating temperature. CSA rating below a 30°C temperature rise.

² Limited by the thermal properties of the connector plastic housing.

³ Use APP® recommended tooling only. Alternate tools may adversely affect the performance of our connectors along with UL and CSA recognition.



| SB®50 CONNECTOR TEMPERATURE CHARTS |

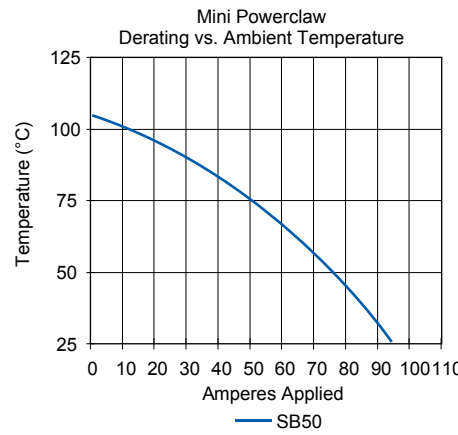
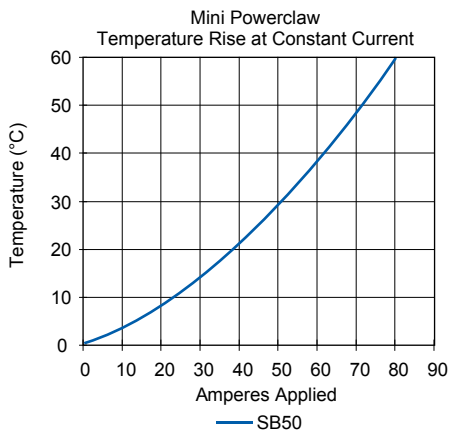
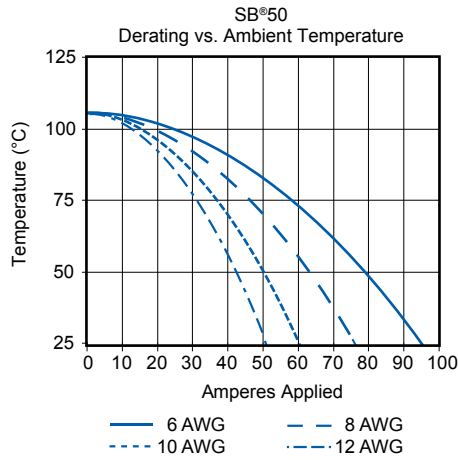
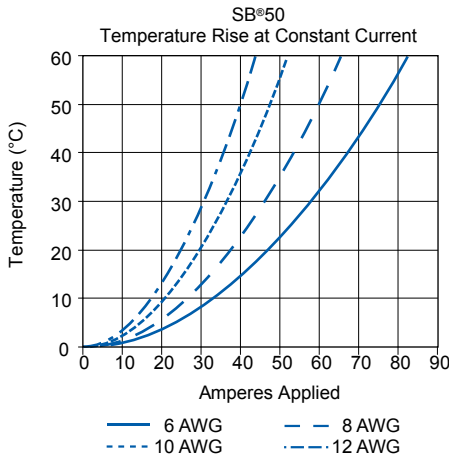

NOTE: Temperature rise charts are based on a 25°C ambient temperature. Powerclaw charts are based on #8 AWG equivalent copper foil on board side, mated to #6 AWG conductor on wire side.

SECTION 3
SB® 50

| SB® Accessories |

"T" Handle

The "T" handle makes mating and unmating the connector easier. The non-conductive red plastic material is strong and safe. (2) Self tapping screws are used to secure the handle to the connector housing.

Description	----- Part Numbers -----	
Minimum Quantity	1,000	50
Red "T" Handle + Hardware Bag	-	SB50-HDL-RED
Hardware Bag (2 Screws)	-	104G17
Red "T" Handle Only	113899P1	-
#8 x 5/8" Screw (Order 2 Per Handle)	H1120P41	-

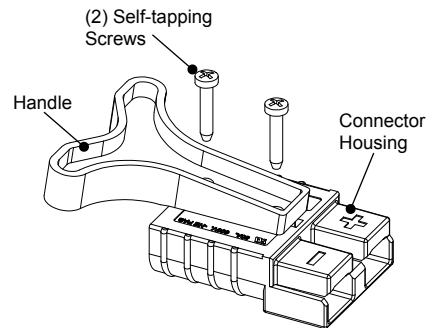

Dust Cover

Prevents dust and dirt from entering the mating interface of the connector when unmated. NOTE: Not a Hermetic Seal.

Description	---- Part Numbers ----	
Minimum Quantity	500	50 ...
Dust Cover with Lanyard Strap, Red	113890P1	134G1

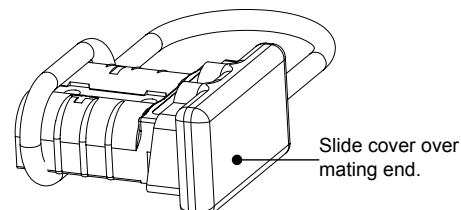

Guide Housings for Vertical Mini Powerclaw Contacts

Prevents polarity being reversed when a SB®50 is mated to vertical mini Powerclaw contacts.

Description	----- Part Numbers -----	
Minimum Quantity	1,000	50
Black Guide Housing	PC-HSG-SB-BK	PC-HSG-SB

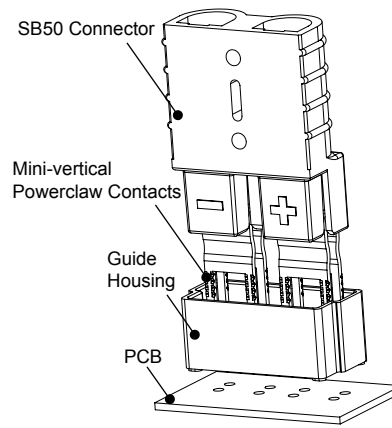

Cable Clamps

Durable metal cable clamps securely hold cables to prevent accidental strain or pulls from dislodging wire or contacts from the housing. Cable clamps are recommended for solder terminated wires.

Description	Cable Size		----- Part Numbers -----	
	AWG or (Inches O.D.)	mm ² or (mm O.D.)		
Minimum Quantity			500	50 ...
Self Attaching for Discrete Conductor	8 to 6	10	990-BK	990
Self Attaching for Discrete Conductor	12 to 10	4 to 6	990G2-BK	990G2
Bolt on for Discrete Conductor	12 to 6	4 to 10	990G1-BK	990G1
Bolt on for Bundled Conductor	(0.320 to 0.450)	(4.27 to 11.43)	5905-BK	5905

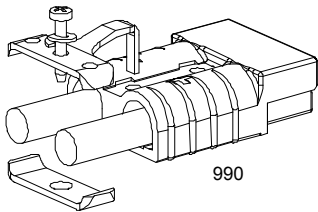

Self attaching discrete conductor.

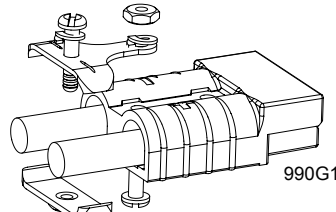

Bolt on discrete conductor.

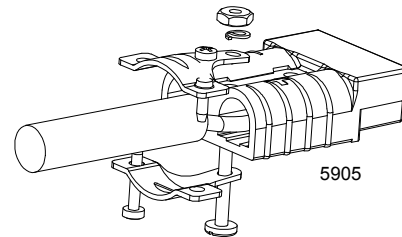

Bolt on bundled conductors.

The given wire O.D. information is an estimate. Cable clamps should be evaluated for performance with the actual wire to be used.

Reducing Bushings

Use with contact part number 5900-BK or 1307-BK to allow a smaller wire to be used with the connector. Electrical capability is derated with smaller wire.

Contact Barrel Size	Wire Size	----- Part Numbers -----			Dimensions			
					- ID -		- Length -	
Minimum Quantity		3,000	1,000	100	inches	mm	inches	mm
#6 AWG [13.3 mm ²]	#8 AWG [8.4 mm ²]	-	5912-BK	5912	0.18	4.57	0.45	11.43
#6 AWG [13.3 mm ²]	#12- 10 AWG [3.3- 5.3 mm ²]	5910-BK	-	5910	0.14	3.56	0.47	11.94
#6 AWG [13.3 mm ²]	#16- 14 AWG [1.3- 2.1 mm ²]	5913-BK	-	5913	0.09	2.29	0.47	11.94

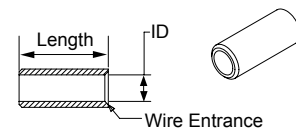

SB120® Connectors

- up to 240 Amps

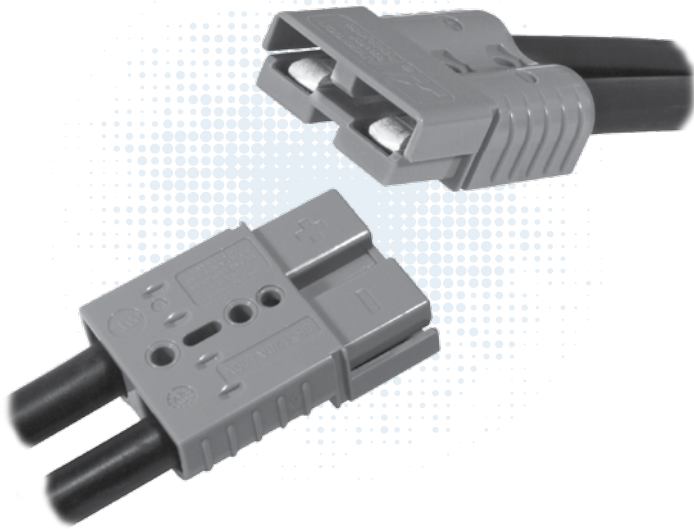

Like the other Multipole connectors, the SB®120 offers color-coded mechanically keyed housings. Keys can be used to identify and separate different circuits, or prevent users from accidentally cross mating different voltages. Wires sizes from #10 (5.3 mm²) to #1 (42.4 mm²) are held in the second smallest SB® housing.

- **New extended range contacts expand wire size up to #1 AWG (42.4 mm²)**
Allows UL rated currents up to 240 amps
- **Chemical resistant housing option**
Extends temperature range down to -40°C, while offering enhanced UV and chemical resistance
- **Panel mounting grooves**
With use of mounting clamps, can be easily mounted through panels

SECTION 3
SB® 120

| SB®120 ORDERING INFORMATION |

SB®120 Standard Housings

The second to smallest SB® housings work with wire contacts up to 1 AWG [35 mm²] as well as busbar contacts. Genderless design mates with itself. Mechanical keys are color coded.

Description	Voltage	Color	Code	----- Part Numbers -----
Minimum Quantity				250 50
Red	24V		6810G3-BK	6810G3
Gray	36V		6810G1-BK	6810G1
Blue	48V		6810G2-BK	6810G2

SB®120 Chemical Resistant (CR) Housings

Same features as the Standard SB®120 but molded in a chemical resistant PBT/ PC blend. Suitable for use to -40°C.

Description	Voltage	Color	Code	----- Part Numbers -----
Minimum Quantity				250 50
Red	24V		P6810G3-BK	P6810G3
Gray	36V		P6810G1-BK	P6810G1

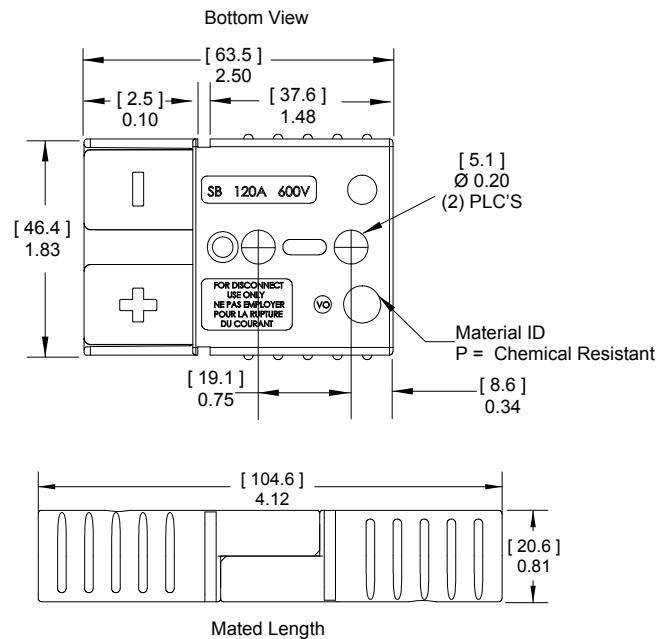

SB®120 Silver Plated Wire Contacts

Silver plated contacts offer superior electrical performance and durability up to 10,000 mating cycles.

AWG	mm ²	Mating Force	Loose Piece Part Numbers			Dimensions			
			-----			- A -		- B -	
Minimum Quantity			600	500	50	inches	mm	inches	mm
1	42.4	Low	1323G1-BK	-	1323G1	0.47	11.94	0.39	9.91
2	33.6	Low	-	6811G6-BK	6811G6	0.44	11.18	0.22	5.59
2	33.6	High	-	1319-BK	1319	0.44	11.18	0.22	5.59
4	21.1	Low	-	6811G5-BK	6811G5	0.44	11.18	0.30	7.62
4	21.1	High	-	1319G4-BK	1319G4	0.44	11.18	0.30	7.62
6	13.3	Low	-	6811G4-BK	6811G4	0.44	11.18	0.34	8.64
6	13.3	High	-	1319G6-BK	1319G6	0.44	11.18	0.34	8.64

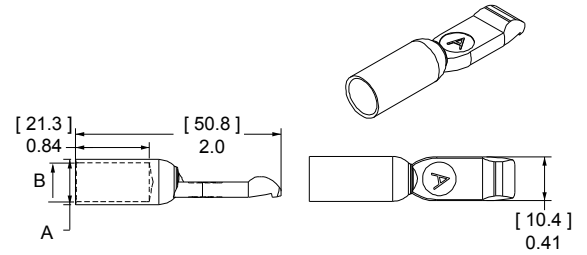

SB®120 Silver Plated Busbar Contacts

Use 2 busbar contacts per housing to provide a quick disconnect input or output busbar connection. Busbar contacts are for mating with wire contacts only.

Part number 120BBS includes lock nuts. Locknuts must be ordered separately for B01997P1.

Type	Thread	Mating Force	Loose Piece Part Numbers			

Minimum Quantity			1,000	300	20	10
Busbar	#10-24	High	-	B01997P1	-	120BBS
Lock Nut	#10-24	-	H1216P8	-	110G54	-

See Busbar contact drawing on website for further detail.

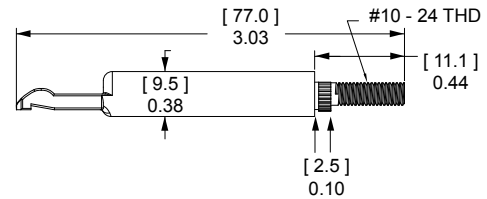

| SB®120 CONNECTOR SPECIFICATIONS |

Electrical		
Current Rating Amperes¹	UL 1977	CSA
Wire to Wire (1 AWG)	240	130
Wire to Busbar (2 AWG)	120	
Voltage Rating AC/DC		
UL 1977	600	
Dielectric Withstanding Voltage		
Volts AC	2,200	
Avg. Mated Contact Resistance Milliohms¹		
5 1/2" of #2 AWG wire	0.136	
Hot Plug Current Rating Amperes - Wire & Busbar		
250 cycles at 120V DC	60A	

Mechanical		
Wire Size Range	AWG	mm²
Wire Contacts with Bushings	10 - 1	5.3 - 42.4
Max. Wire Insulation Diameter	in.	mm
	0.600	15.240
Operating Temperature²	°F	°C
Standard	-4° to 221°	-20° to 105°
Chemical Resistant*	-40 to 221°	-40° to 105°
Mating Cycles No Load by Plating	Silver (Ag)	
Wire and Busbar Contacts	10,000	
Avg. Mating / Unmating Force	Lbf.	N
Wire to Wire	20	89
Min. Contact / Spring Retention Force		
lbf	75	
N	333.6	

Materials	
Housing	
Standard Plastic Resin	Polycarbonate
Chem. Resistant Resin	Polycarbonate / PBT blend
Contact Retention Spring	Stainless Steel
Housing Flammability Rating	
UL94	V-0
Wire & Busbar Contacts	
Base	Copper Alloy
Plating	Silver
Contact Termination Methods	
Crimp ³	Wire Contacts
Hand Solder	Wire Contacts
Wrench / Socket	Busbar Contacts Only

Protection	
Touch Safety with Wire Contacts	
IEC 60529	IP10



¹ Based on: 105°C rated or better cable of the largest size, Properly calibrated APP® recommended tooling, and a 25°C ambient temperature. UL rating not to exceed the maximum operating temperature. CSA rating below a 30°C temperature rise.
² Limited by the thermal properties of the connector plastic housing.
³ Use APP® recommended tooling only. Alternate tools may adversely affect the performance of our connectors along with UL and CSA recognition.

SECTION 3
SB®120

| SB®120 CONNECTOR TEMPERATURE CHARTS |

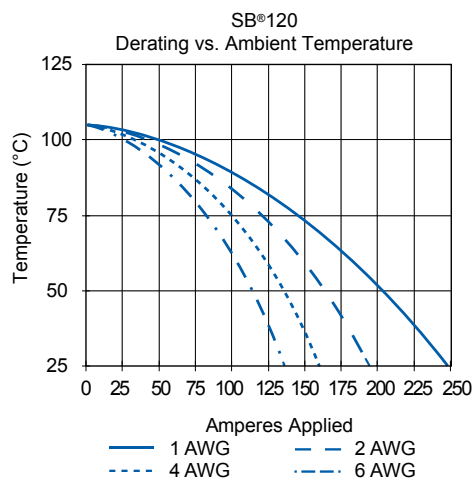
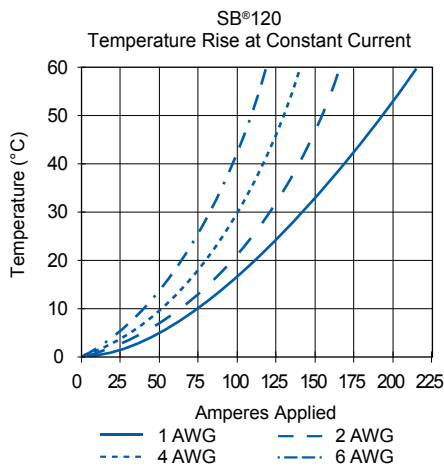

NOTE: Temperature rise charts are based on a 25°C ambient temperature.

| SB® 120 Accessories |

Mounting Clamp for SB®120

Mounting clamps can be used for fastening a SB®120 series housings to a panel. Fastening hardware not included.

Description	--- Part Number ---
Minimum Quantity	20 sets of 2
Panel Mount Bracket for SBS®50	1467G1

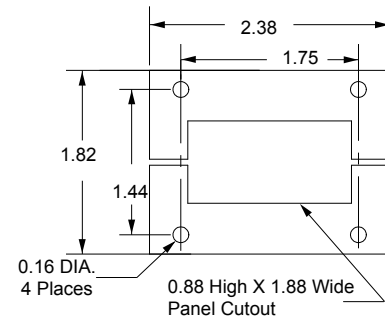

Cable Clamps

Durable metal cable clamps securely hold cables to prevent accidental strain or pulls from dislodging wire or contacts from the housing. Cable clamps are recommended for solder terminated wires.

Description	Cable Size		- Part Numbers -
	Min / Max Inches O.D.	Min / Max mm O.D.	
Minimum Quantity			50
Bolt on for Discrete Conductor	0.70 to 0.23	17.7 to 5.8	981G1
Bolt on for Bundled Conductor	0.73 to 0.29	18.5 to 7.3	981G2

The given wire O.D. information is an estimate. Cable clamps should be evaluated for performance with the actual wire to be used.

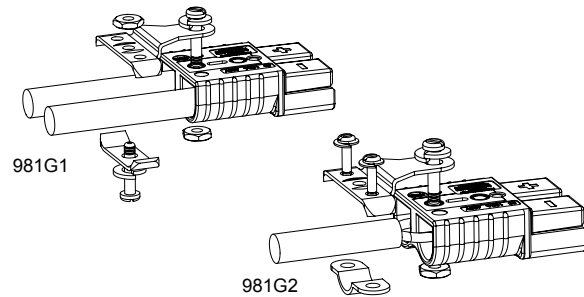

“T” Handle

The “T” handle makes mating and unmating the connector easier. The non-conductive red plastic material is strong and safe. (2) Self tapping screws are used to secure the handle to the connector housing.

Description	----- Part Numbers -----	
Minimum Quantity	1,000	50
Red “T” Handle + Hardware Bag	-	SB120-HDL-RED
Red “T” Handle Only	113899P1	-
#8 x 7/8” Screw (Order 2 Per Handle)	H1120P43	-

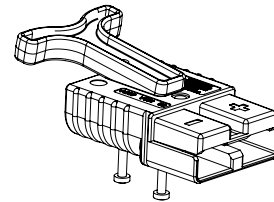

Dust Cover

Prevents dust and dirt from entering the mating interface of the connector when unmated. NOTE: Not a Hermetic Seal.

Description	----- Part Numbers -----	
Minimum Quantity	100	50
Dust Cover with Lanyard Strap, Black	B02019P1	134G4

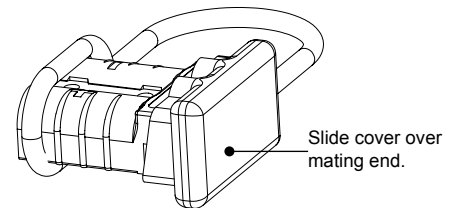

Reducing Bushings

Use with contact part number 1319-BK or 6811G6-BK to allow a smaller wire to be used with the connector. Electrical capability is derated with smaller wire.

Contact Barrel Size	Wire Size	----- Part Numbers -----			Dimensions - ID -	
					inches	mm
Minimum Quantity		2,000	1,000	100		
#2 AWG [33.6 mm²]	#4 AWG [21.2 mm²]	5919-BK	-	5919	0.28	7.11
#2 AWG [33.6 mm²]	#6 AWG [16 mm²]	-	5920-BK	5920	0.23	5.84
#2 AWG [33.6 mm²]	#10 - 8 AWG [5.3 - 8.4 mm²]	5921-BK		5921	0.18	4.57

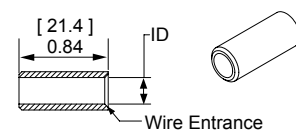

SB175® Connectors - up to 280 Amps

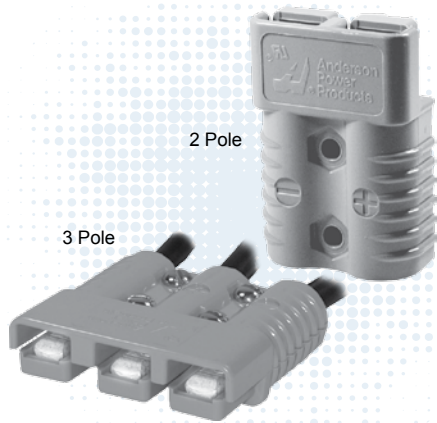

Wires sizes from #12 (3.3 mm²) to 1/0 (50 mm²) fit in the second to largest connector in the SB® series. The 3 pole SB®175 adds an additional position for power or grounding. All Multipole wire connector housings are genderless and mate to themselves minimizing inventory and assembly complexity.

- **Silver Plated Wire Contacts up to 1/0 (50 mm²)**
Allows UL rated currents up to 280 amps
- **Chemical Resistant Housing Option**
Extends temperature range down to -40°C, while offering enhanced UV and chemical resistance
- **UL Rated for Hot Plugging up to 100 Amps**
Great for battery or other applications where the ability to interrupt circuits is required

| SB®175 ORDERING INFORMATION |

SB®175 Standard Housings

The second to largest SB® housings work with wire contacts up to 1/0 AWG [50 mm²] as well as busbar contacts. Genderless design mates with itself. Mechanical keys are color coded. NOTE: SB175 black is keyless and can be mated with all other colors.

Description	Voltage Color Code	--- Part Numbers ---	
Minimum Quantity		200	50 ...
Yellow	12V	943-BK	943
Orange	18V	942-BK	942
Red	24V	949-BK	949
Gray	36V	940-BK	940
Blue	48V	941-BK	941
Black (Keyless)	80V	2-7252G11	-
Brown	96V	940-BK	940

SB®175 Chemical Resistant Housings

Same features as the Standard SB®175 but molded in a chemical resistant PBT/ PC blend. Suitable for use to -40°C.

Description	Voltage Color Code	---- Part Numbers ----	
Minimum Quantity		200	50 ...
Red	24V	P949-BK	P949
Gray	36V	P940-BK	P940

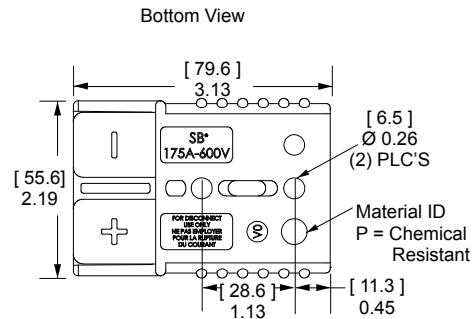

Mated Length

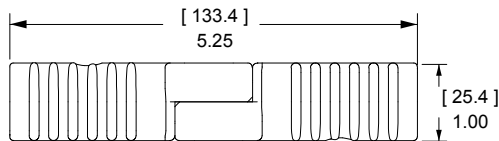

SB®175 3 Pole Housings & Hardware

A three pole version of the standard SB®175 housing has a two piece housing with springs and hardware. Useful for DC 2 wire plus ground and AC single phase applications.

Description	Voltage	Part Numbers	
	Color Code	---	---
Minimum Quantity		100	25
Gray Housing and Hardware Kit	36V	-	902
Gray Housing Top Half	-	2-5048	-
Gray Housing Bottom Half	-	2-5049	-
Hardware Kit	-	-	110G34

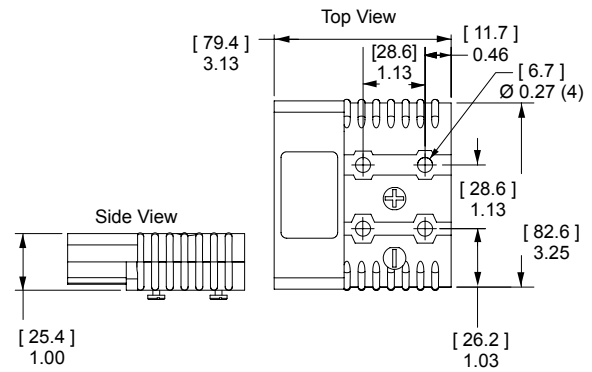

SB®175 Silver Plated Wire Contacts

Silver plated contacts offer superior electrical performance and durability up to 10,000 mating cycles.

AWG	mm ²	Mating Force	Loose Piece - Part Numbers -	Dimensions							
				- A -		- B -		- C -		- D -	
				inches	mm	inches	mm	inches	mm	inches	mm
Minimum Quantity			500 50								
1/0	53.5	High	1382-BK 1382	2.35	59.69	0.52	13.21	0.44	11.18	1.04	26.42
1	42.4	High	1347-BK 1347	2.35	59.69	0.52	13.21	0.39	9.91	1.04	26.42
2	33.6	High	1383-BK 1383	2.35	59.69	0.52	13.21	0.35	8.89	1.04	26.42
4	21.1	High	1384-BK 1384	2.35	59.69	0.52	13.21	0.30	7.62	1.04	26.42
6	13.3	High	1348-BK 1348	2.10	53.34	0.37	9.40	0.22	5.59	0.80	20.32

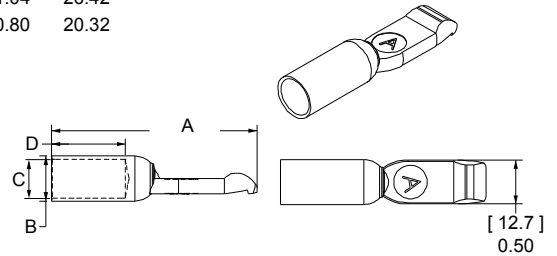

SB®175 Silver Plated Busbar Contacts

Provides a quick disconnect input or output busbar connection. Busbar contacts are for mating with wire contacts only. Part number 180BBS includes lock nuts. Locknuts must be ordered separately for 180BBS-BK.

Type	Thread	Mating Force	Loose Piece Part Numbers		
Minimum Quantity			1,000	120	10
Busbar	1/4-20	High	-	180BBS-BK	180BBS
Lock Nut	1/4-20	-	H1216P7	110G56	110G55

See Busbar contact drawing on website for further detail.

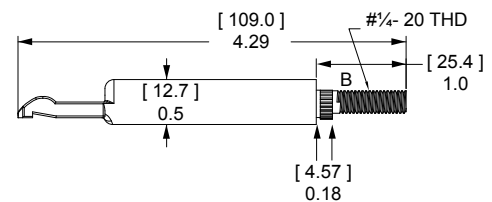

SB®175 CONNECTOR SPECIFICATIONS |

Electrical

Current Rating Amperes¹	UL 1977	CSA
Wire to Wire (1/0 AWG)	280	175
Wire to Busbar (1/0 AWG)	200	
Voltage Rating AC/DC		
UL 1977	600	
Dielectric Withstanding Voltage		
Volts AC	2,200	
Avg. Mated Contact Resistance Milliohms¹		
6" of 1/0 AWG wire	0.100	
UL Hot Plug Current Rating Amperes - Wire & Busbar		
250 cycles at 120V DC 1/0 wire	100A	

Materials

Housing	
Standard Plastic Resin	Polycarbonate
Chem. Resistant Resin	Polycarbonate / PBT blend
Contact Retention Spring	Stainless Steel
Housing Flammability Rating	
UL94	V-0
Wire & Busbar Contacts	
Base	Copper Alloy
Plating	Silver
Contact Termination Methods	
Crimp ³	Wire Contacts
Hand Solder	Wire Contacts
Wrench / Socket	Busbar Contacts

Mechanical

Wire Size Range	AWG	mm²
Wire Contacts with Bushings	12 to 1/0	3.3 to 53.5
Max. Wire Insulation Diameter	in.	mm
	0.600	15.240
Operating Temperature²	°F	°C
Standard	-4° to 221°	-20° to 105°
Chemical Resistant*	-40 to 221°	-40° to 105°
Mating Cycles No Load by Plating	Silver (Ag)	
Wire and Busbar Contacts	10,000	
Avg. Mating / Unmating Force	Lbf.	N
2 Pole	25	111
3 Pole	35	156
Min. Contact / Spring Retention Force		
lbf	150	
N	667	

Protection

Touch Safety with Wire Contacts	
IEC 60529	IP10

¹ Based on: 105°C rated or better cable of the largest size, Properly calibrated APP® recommended tooling, and a 25°C ambient temperature. UL rating not to exceed the maximum operating temperature. CSA rating below a 30°C temperature rise.

² Limited by the thermal properties of the connector plastic housing.

³ Use APP® recommended tooling only. Alternate tools may adversely affect the performance of our connectors along with UL and CSA recognition.



SB®175 CONNECTOR TEMPERATURE CHARTS |

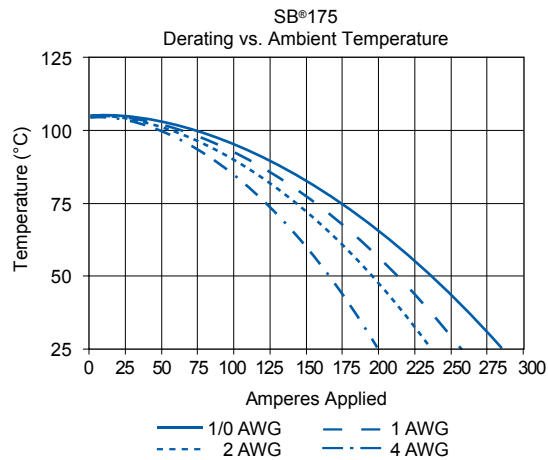
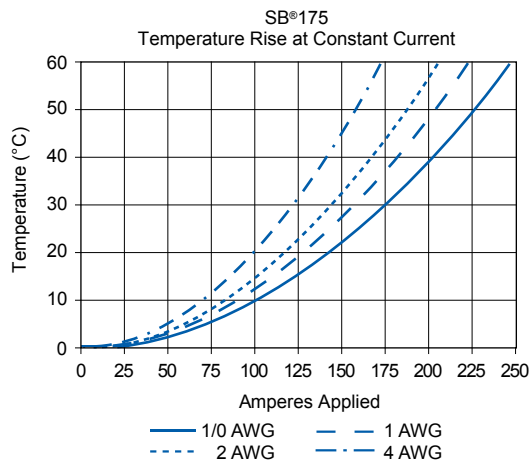

NOTE: Temperature rise charts are based on a 25°C ambient temperature.

| SB® 175 Accessories |

Cable Clamps

Durable metal cable clamps securely hold cables to prevent accidental strain or pulls from dislodging wire or contacts from the housing. Only Bolt On type clamps can be used with the handles. Cable clamps are recommended for solder terminated wires. Not for use with 3 pole housing.

Description	Cable Size		--- Part Numbers ---	
	Max / Min In. Inches O.D.	Max / Min mm mm O.D.	100	50
Self Attaching for Discrete Conductor	0.55 to 0.24	14 to 6	105G3	945
Bolt On for Discrete Conductor	0.66 to 0.24	16.7 to 6.2	945G3-BK	945G3
Bolt On for Bundled Conductor	0.75 to 0.29	18.3 to 7.3	946G1-BK	946G1

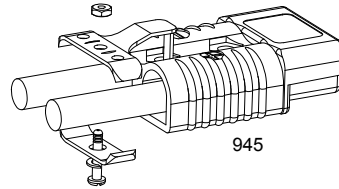
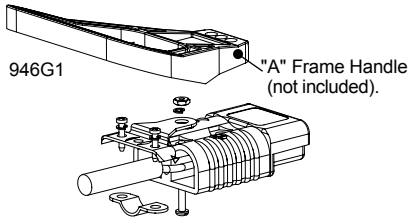
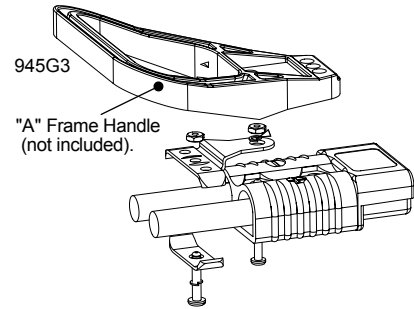

The given wire O.D. information is an estimate. Cable clamps should be evaluated for performance with the actual wire to be used.

Handles

Handles are made out of durable PC plastic. Hardware to attach to connector body included in kits. Not for use with 3 pole housing.

Description	---- Part Numbers ----	
Minimum Quantity	100	25 ...
Gray Handle Kit	995G1-APP	995G1
Red Handle Kit	995G3-APP	995G3
Handle Only, Gray	3-5074P1	-
Handle Only, Red	3-5074P3	-
Handle Only, Black	3-5074P5	-
Hardware Bag	-	105G8

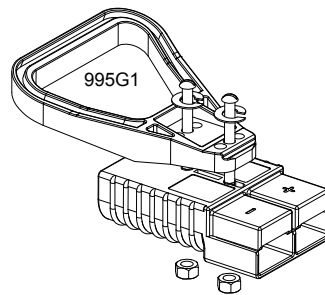

Dust Cover

Prevents dust and dirt from entering the mating interface of the connector when unmated. NOTE: Not a Hermetic Seal. Not for use with 3 pole housing.

Description	---- Part Numbers ----	
Minimum Quantity	500	50 ...
Dust Cover with Lanyard Strap, Red	113890P2	134G2

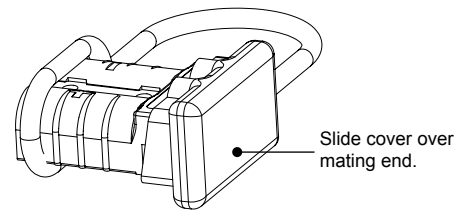

SB®175 Lockout

Works with standard lockout - tagout equipment to prevent access to the mating interface of the connector. Made from durable PC plastic. Can be used with 3 pole housing to lockout positive and negative positions only.

Description	----- Part Numbers -----	
Minimum Quantity	50	25
Red Lockout - Tagout Kit	GA-175	SB175-LOCKOUT

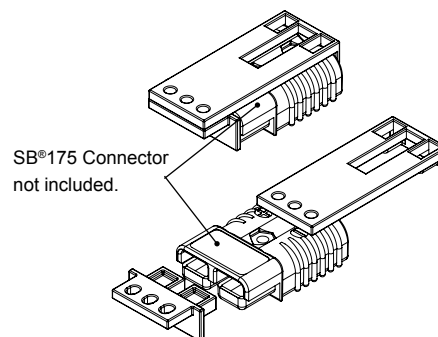

Manual Release Bracket - Mounting Side

Works with the Locking Side to ease mating and unmating connectors. Not for use with 3 pole housing.

Description	----- Part Numbers -----		
Minimum Quantity	96	25	10 ...
Bracket and Hardware Kit	-	-	924
Bracket Only	B00333P1	-	-
Hardware Bag	-	105G1	-

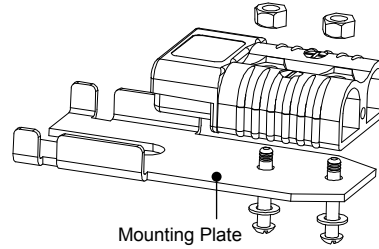

Manual Release Bracket - Locking Side

Works with the Mounting Side to ease mating and unmating connectors. Not for use with 3 pole housing.

Description	Cable Size		- Part Number -
	Max / Min Inches O.D.	Max / Min mm O.D.	
Minimum Quantity			10
Bracket and Hardware Kit w/ Clamp	0.50 to 0.21	12.6 to 5.4	923

The given wire O.D. information is an estimate. Cable clamps should be evaluated for performance with the actual wire to be used.

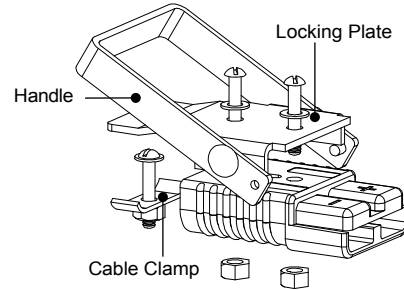

Reducing Bushings: for Use with Contact # 1382

Use with contact part number 1382-BK to allow a smaller wire to be used with the connector. Electrical capability is derated with smaller wire.

Contact Barrel Size	Wire Size	----- Part Numbers -----				Dimensions - ID - inches mm	
		1,500	1,000	500	100		
1/0 AWG [53.5 mm ²]	#1 AWG [42.4 mm ²]	-	-	5687-BK	5687	0.39	9.91
1/0 AWG [53.5 mm ²]	#2 AWG [33.6 mm ²]	5690-BK	-	-	5690	0.34	8.64
1/0 AWG [53.5 mm ²]	#4 AWG [21.2 mm ²]	-	5693-BK	-	5693	0.27	6.86
1/0 AWG [53.5 mm ²]	#6 AWG [13.3 mm ²]	-	5663-BK	-	5663	0.22	5.59
1/0 AWG [53.5 mm ²]	#10 - 8 AWG [5.3 - 8.4 mm ²]	5648-BK	-	-	5648	0.19	4.83

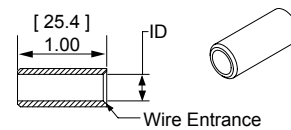

SB350® Connectors - up to 450 Amps



The SB®350 is the largest connector in the series with power capabilities up to 450 amps with 4/0 wire. Wires ranging from #1/0 (50 mm²) to 300 mcm (152 mm²) fit into the one piece housing available in standard PC or a chemical resistant PBT/PC blend. Silver plated wire or busbar contacts minimize electrical resistance while offering supreme durability and reliability.

- **Up to 300 mcm (152 mm²) Wires**
Allows UL rated currents up to 450 amps with 4/0 wire
- **Chemical Resistant Housing Option**
Extends temperature range down to -40°C, while offering enhanced UV and chemical resistance
- **Same Housings Used for Wire and Busbar Contacts**
Enables color-coded mechanically keyed wire to busbar connections

| SB®350 ORDERING INFORMATION |

SB®350 Standard Housings

The largest SB® housings work with wire contacts up to 300 mcm [150 mm²] as well as busbar contacts. Genderless design mates with itself. Mechanical keys are color coded. NOTE: SB350 Black and Blue Housings have the same keying features and can be intermated.

Description	Voltage		Part Numbers	
	Color	Code	---	---
Minimum Quantity			50	25 ...
Yellow	12V	914-BK	914	
Orange	18V	932-BK	932	
Red	24V	913-BK	913	
Gray	36V	906-BK	906	
Blue	48V	912-BK	912	
Green	72V	931-BK	931	
Black	80V	2-7250G8	-	

SB®350 Chemical Resistant Housings

Same features as the Standard SB®350 but molded in a chemical resistant PBT/ PC blend. Suitable for use to -40°C.

Description	Voltage		Part Numbers	
	Color	Code	---	---
Minimum Quantity			50	25
Red	24V	P913-BK	P913	
Gray	36V	P906-BK	P906	

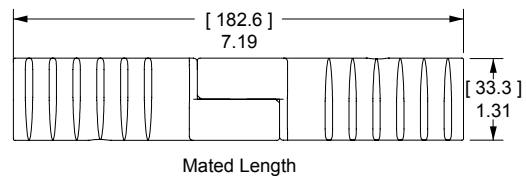
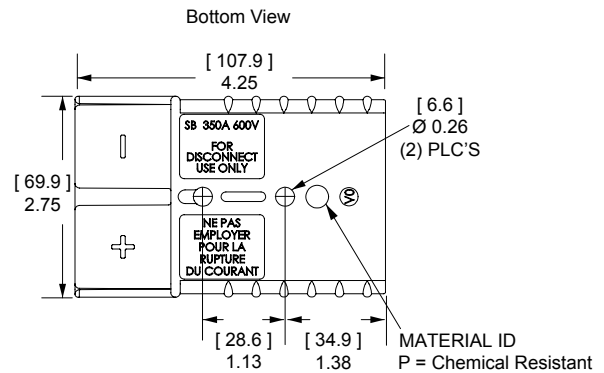

SECTION 3
SB® 350

SB®350 Silver Plated Wire Contacts

Silver plated contacts offer superior electrical performance and durability up to 10,000 mating cycles.

AWG	mm ²	Mating Force	- Loose Piece Part Numbers -			Dimensions			
						- A -		- B -	
					inches	mm	inches	mm	
Minimum Quantity			200	150	50				
300mcm	152	High	-	910-BK	910	0.75	19.05	0.87	22.10
4/0	107.2	High	908-BK	-	908	0.64	16.26	0.75	19.05
3/0	85	High	916-BK	-	916	0.58	14.73	0.70	17.78
2/0	67.4	High	907-BK	-	907	0.49	12.45	0.64	16.26
1/0	53.5	High	917-BK	-	917	0.44	11.18	0.51	12.95

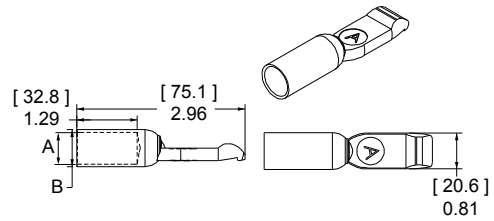

SB®350 Silver Plated Busbar Contacts

Use 2 busbar contacts per housing to provide a quick disconnect input or output busbar connection. Busbar contacts are for mating with wire contacts only. Part number 350BBS includes lock nuts. Locknuts must be ordered separately for B01998P1.

Type	Thread	Mating Force	- Loose Piece Part Numbers -	
Minimum Quantity			50	10
Busbar	1/4-20	High	B01998P1	350BBS
Lock Nut	1/4-20	-	H1216P9	110G73

See Busbar contact drawing on website for further detail.

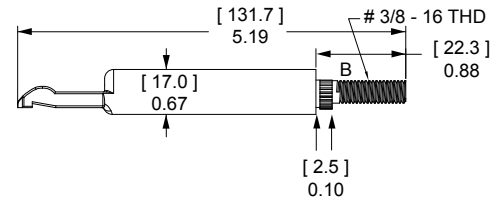

SB®350 CONNECTOR SPECIFICATIONS |

Electrical

Current Rating Amperes¹	UL 1977	CSA
Wire to Wire (4/0 AWG)	450	350
Voltage Rating AC/DC		
UL 1977	600	
Dielectric Withstanding Voltage		
Volts AC	2,200	
Avg. Mated Contact Resistance Milliohms¹		
2 1/2" of 300mcm wire	0.050	
Hot Plug Current Rating Amperes - Wire & Busbar		
250 cycles at 120V DC	100A	

Materials

Housing	
Standard Plastic Resin	Polycarbonate
Chem. Resistant Resin	Polycarbonate / PBT blend
Contact Retention Spring	Stainless Steel

Housing Flammability Rating

UL94	V-0
------	-----

Wire & Busbar Contacts

Base	Copper Alloy
Plating	Silver

Contact Termination Methods

Crimp ³	Wire Contacts
Hand Solder	Wire Contacts
Wrench / Socket	Busbar Contacts

Mechanical

Wire Size Range	AWG	mm²
Wire Contacts with Bushings	1/0 to 300 mcm	53.5 to 152
Max. Wire Insulation Diameter	in.	mm
	1.100	27.900
Operating Temperature²	°F	°C
Standard	-4° to 221°	-20° to 105°
Chemical Resistant	-40 to 221°	-40° to 105°
Mating Cycles No Load by Plating	Silver (Ag)	
Wire and Busbar Contacts	10,000	
Avg. Mating / Unmating Force	Lbf.	N
2 Pole	30	133
Min. Contact / Spring Retention Force		
lbf	150	
N	667	

Protection

Touch Safety with Wire Contacts

IEC 60529	IP10
-----------	------

¹ Based on: 105°C rated or better cable of the largest size, Properly calibrated APP® recommended tooling, and a 25°C ambient temperature. UL rating not to exceed the maximum operating temperature. CSA rating below a 30°C temperature rise.

² Limited by the thermal properties of the connector plastic housing.

³ Use APP® recommended tooling only. Alternate tools may adversely affect the performance of our connectors along with UL and CSA recognition.



| SB® 350 CONNECTOR TEMPERATURE CHARTS |

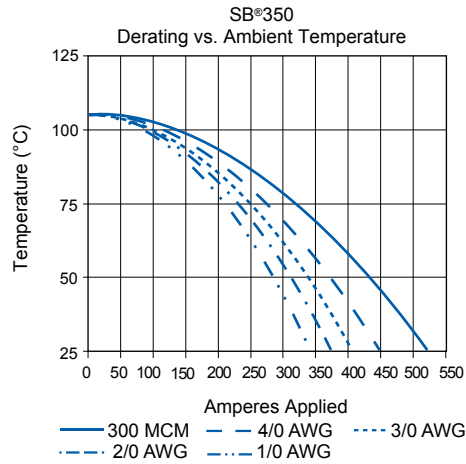
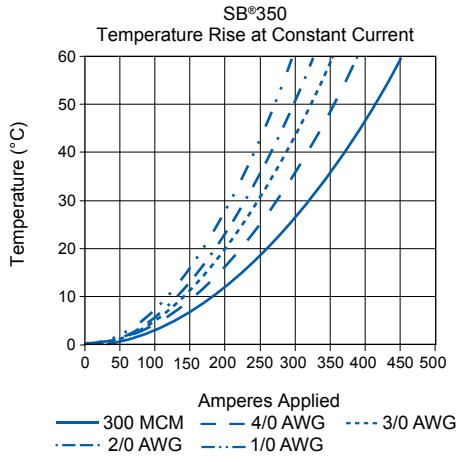

NOTE: Temperature rise charts are based on a 25°C ambient temperature.

| SB® 350 Accessories |

Cable Clamps

Durable metal cable clamps securely hold cables to prevent accidental strain or pulls from dislodging wire or contacts from the housing. Cable clamps are recommended for solder terminated wires.

Description	Cable Size		- Part Number -
	Min / Max Inches O.D.	Min / Max mm O.D.	
Minimum Quantity			10
Bolt On for Discrete Conductor	1.00 to 0.35	25.4 to 8.8	996G1
Discrete Conductor w/ Integral Handle	0.76 to 0.32	19.3 to 8.2	911

The given wire O.D. information is an estimate. Cable clamps should be evaluated for performance with the actual wire to be used.

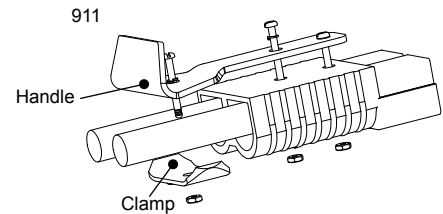
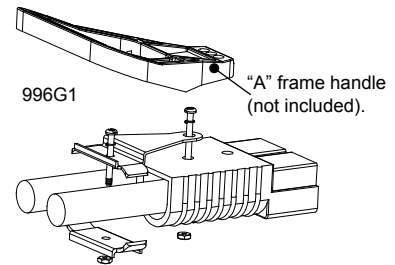

Handles

Handles are made out of durable PC plastic. Hardware to attach to connector body included in kits.

Description	----- Part Numbers -----	
Minimum Quantity	100	25 ...
Gray Handle Kit	995G2-APP	995G2
Red Handle Kit	995G4-APP	995G4
Handle Only, Gray	3-5074P1	-
Handle Only, Red	3-5074P3	-
Handle Only, Black	3-5074P5	-
Hardware Bag	-	106G7

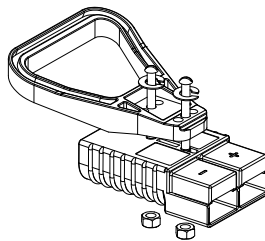

Dust Cover

Prevents dust and dirt from entering the mating interface of the connector when unmated. NOTE: Not a Hermetic Seal.

Description	----- Part Numbers -----	
Minimum Quantity	500	50 ...
Dust Cover with Lanyard Strap, Red	113890P3	134G3

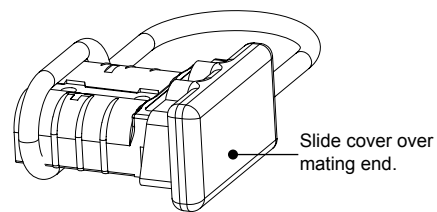

SECTION 3
SB® 350

SB®350 Lockout

Works with standard lockout - tagout equipment to prevent access to the mating interface of the connector. Made from durable PC plastic.

Description	----- Part Numbers -----	
Minimum Quantity	50	25
Red Lockout - Tagout Kit	GA-350	SB350-LOCKOUT

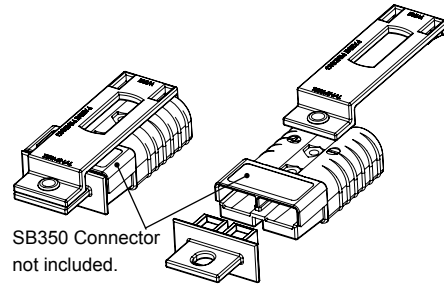

Manual Release Bracket - Mounting Side

Works with the Locking Side to ease mating and unmating connectors.

Description	----- Part Numbers -----		
Minimum Quantity	66	25	10 ...
Bracket and Hardware Kit	-	-	922G1
Bracket Only	B00229P1	-	-
Hardware Bag	-	106G6	-

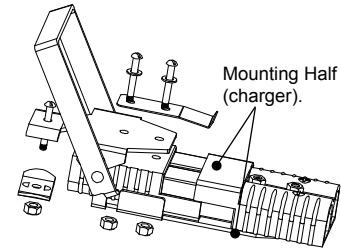

Manual Release Bracket - Locking Side with Cable Clamp

Works with the Mounting Side to ease mating and unmating connectors.

Description	Cable Size		- Part Numbers -
	Min / Max Inches O.D.	Min / Max mm O.D.	
Minimum Quantity			10
Bracket and Hardware Kit w/ Clamp Kit	0.94 to 0.61	23.7 to 15.5	919

The given wire O.D. information is an estimate. Cable clamps should be evaluated for performance with the actual wire to be used.

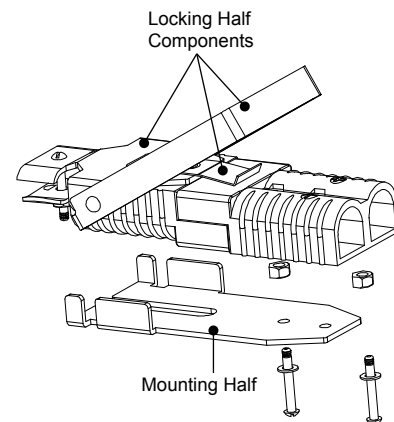

Manual Release Bracket - Locking Side no Cable Clamp

Works with the Battery side to ease mating and unmating connectors.

Description	- Part Numbers -
Minimum Quantity	10
Bracket and Hardware Kit No Clamp Kit	919G1

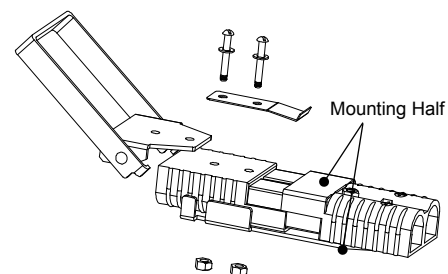

Reducing Bushings: for Use with Contact # 907

Use with contact part number 907-BK to allow a smaller wire to be used with the connector. Electrical capability is derated with smaller wire.

Contact Barrel Size	Wire Size	--- Part Numbers ---	
Minimum Quantity		500	100 ...
2/0 AWG [67.4 mm²]	1/0 AWG [53.5 mm²]	5918-BK	5918

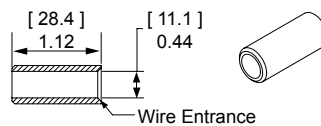

SB®

- Tooling Information

Wire Size		Loose Piece Part Numbers	Loose Piece Contact Crimp Tools				Reeled Part Numbers	Reeled Contact Crimp Tools			
AWG	mm²		Hand Tool or	Pneumatic Bench Tool	+ Die	+ Locator	Number of Crimps	Tin Plating	ATS Applicator	ATS Press	Air Feed Kit
SB50											
#6	13.3	1307 5900	1309G4	1387G1	1388G6	1389G6	Single	265G5	1385523-1	2-565435-2	692655-1
#8	8.4	5952			1388G7						
#10 / 12	5.3 / 3.3	5953 5915									
SB120											
#1	42.4	1323G1	1368	1387G1	1388G3	1389G4	Single	N/A		N/A	
#2	33.6	1319			1388G4						
#4	21.2	1319G4									
#6	13.3	1319G6									
SB175											
1/0	53.5	1382	1368	1387G2	1303G13	1304G32	Double	N/A		N/A	
#1	42.4	1347		1387G1	1388G3	1389G3	Single				
#2	33.6	1383		1387G2	1303G13	1304G32	Double				
#4	21.1	1384		1387G1	1388G3	1389G3	Single				
				1387G2	1303G13	1304G32	Double				
#6	13.3	1348		1387G1	1388G4	1389G3	Single				
SB350											
300mcm	152	910	1368	1387G2	N/A		Single	N/A		N/A	
4/0	107.2	908			1303G3						
3/0	85	916			1303G12	1304G31	Double				
2/0	67.4	907									
1/0	53.5	917									

NOTE: See website for the most current information.

| Scratch Pad |

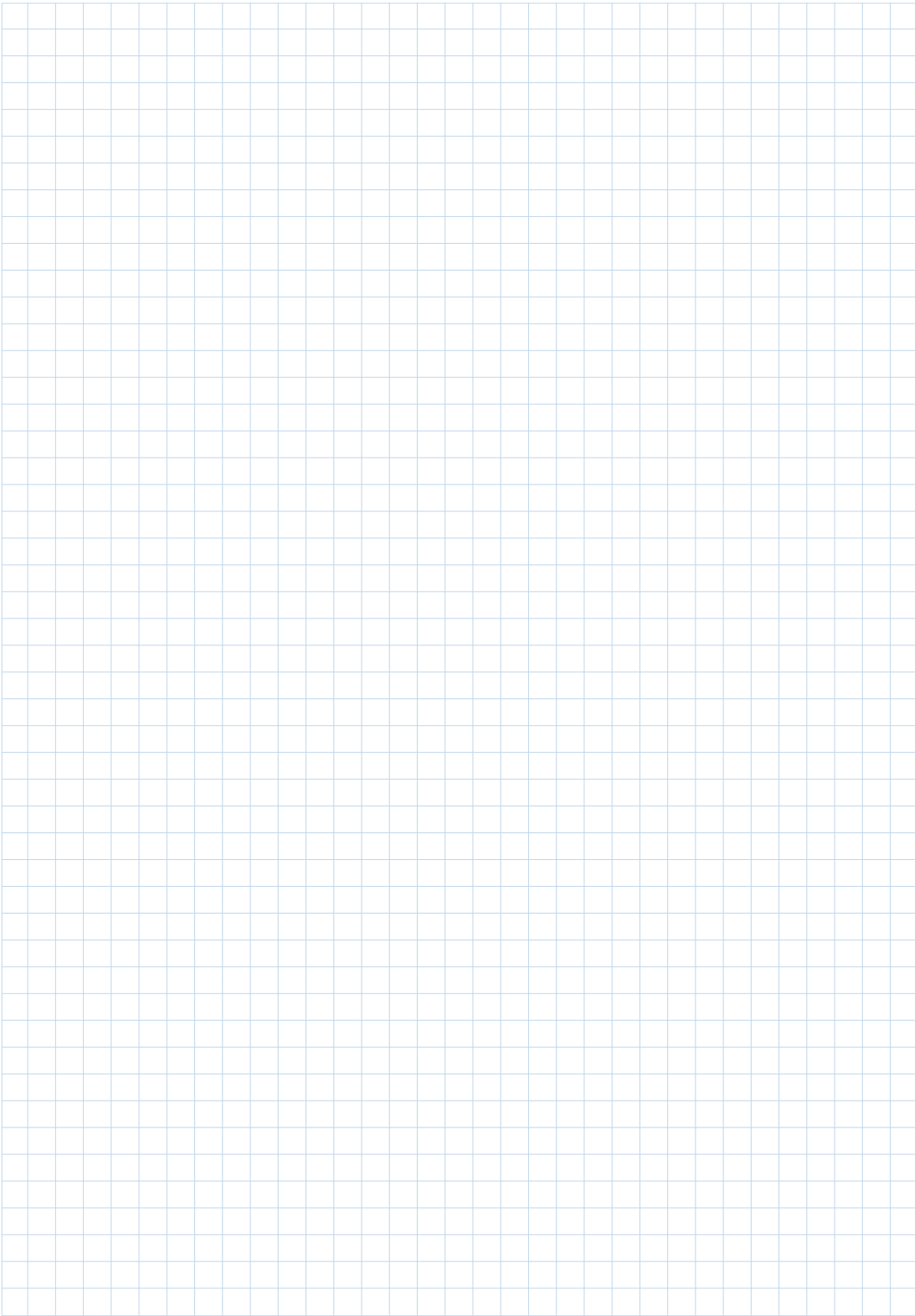

SECTION 3
SBE® 80 / SBO® 60

SBE®80 / SBO® 60 Connectors - up to 80 Amps



SBE® and SBO® connectors build on the capability of the two pole SB® connectors by offering up to 8 auxiliary power / signal contacts along with an IEC 60950 touch safe housing. The center of the main connector features a connector holder for either: two PP15-45, two PPMX, or APP's innovative 1x4 auxiliary connector.

- Touch Safe Interface**
Minimizes potential contact with live circuits per IEC 60950
- Up to 8 Last Mate / First Break Auxiliary's**
Enables intelligent power switching, CAN and interlock loop circuitry, as well as power up to 20 amps per pole
- Silver Plated Wire Contacts up to #4 (25 mm²)**
Allows UL rated currents up to 80 amps per pole

| SBE®80 / SBO®60 ORDERING INFORMATION |

SBE®80 / SBO®60 Housings

The smallest size of SBE®, X, O style housing. SBE® housings are molded from a chemical resistant PBT. SBO® housings are molded from PC. SBE®80 and SBO®60 housings of the same Voltage Color Code can be mated but is not recommended as it invalidates UL approvals. SBO®60 housings do not meet EN1175-1 requirements for industrial trucks.

Description	Voltage Color Code	----- SBE®80 Part Numbers -----		----- SBO®60 Part Numbers -----	
		400	25	400	25
Minimum Quantity		400	25	400	25
Yellow	12V	SBE80YEL-BK	SBE80YEL	SBO60YEL-BK	SBO60YEL
Orange	18V	SBE80ORN-BK	SBE80ORN	SBO60ORN-BK	SBO60ORN
Red	24V	SBE80RED-BK	SBE80RED	SBO60RED-BK	SBO60RED
Gray	36V	SBE80GRA-BK	SBE80GRA	N/A	N/A
White	144V	N/A	N/A	SBO60WHT-BK	SBO60WHT

SBE®80 / SBO®60 Silver Plated Primary Power Wire Contacts

Use two silver plated contacts per housing for the best electrical performance and durability up to 10,000 mating cycles.

AWG	mm ²	Mating Force	- Loose Piece Part Numbers -		Dimensions			
					- A -		- B -	
					inches	mm	inches	mm
Minimum Quantity			1,000	100				
4	25	Low	1339G4-BK	1339G4	0.28	7.11	0.35	9.0
6	16	High	1339G1-BK	1339G1	0.22	5.59	0.29	7.3

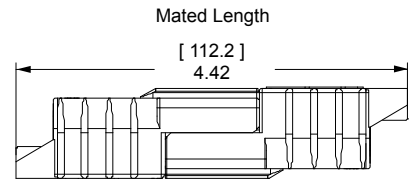
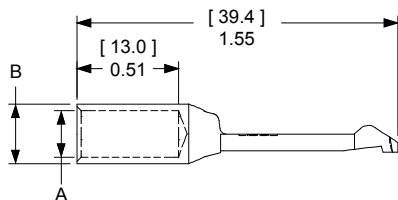

Side View

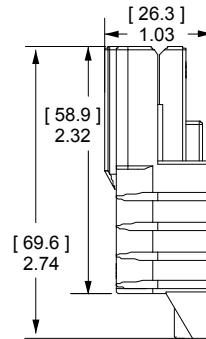

Top View

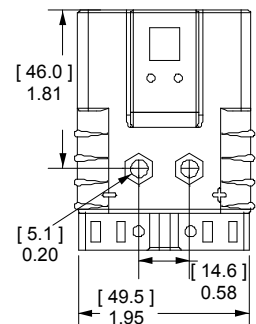

SECTION 3
SBE® 80 / SBO® 60

| SBE®80 / SBO®60 CONNECTOR SPECIFICATIONS |

Electrical

Current Rating Amperes ¹	SBO60	SBE80
Primary Power (6 AWG)	70	80
Powerpole® Auxiliary (12 AWG)	20	20
1x4 Auxiliary (12 AWG)	20	20
PPMX Auxiliary (20 AWG)	7 UL	5 CSA
Voltage Rating AC/DC		
	UL 1977	EN1175-1
Primary Power	600	150 ⁴
Powerpole® Auxiliary	600	150 ⁴
1x4 Auxiliary	200	
PPMX Auxiliary	300	
Dielectric Withstanding Voltage Primary Power		
Volts AC	2,200	
Avg. Mated Contact Resistance Milliohms ¹		
1 1/4" of #6 AWG wire	0.200	
Hot Plug Current Rating Amperes - 250 cycles at 120V DC		
Power	60A	
Powerpole® Auxiliary	30A	
1x4 Auxiliary	5A	

Materials

Housing	
SBO® and Powerpole® Plastic Resin	Polycarbonate
SBE® and 1x4 Auxiliary Housing	Polycarbonate / PBT blend
Contact Retention Spring	Stainless Steel
Housing Flammability Rating	
UL94	V-0
Power & Powerpole® Contact	
	Silver Plated Copper Alloy
1x4 Auxiliary Contacts	
Pin	Copper alloy, Au over Ni
Socket	BeCu, Au over Ni
Socket Body	Copper alloy, Sn bright over Ni
Retention Clip	Stainless Steel
PPMX Contacts	
	Gold Plated Copper Alloy
Contact Termination Methods	
Crimp ³	
Hand Solder	

Mechanical

Wire Size Range	AWG	mm ²
Power Contacts	16 to 6	1.3 to 13.3
Auxiliary Contacts	24 to 10	0.25 to 5.3
Max. Wire Insulation Diameter		
	in.	mm
Power Contacts	0.440	11.200
Powerpole® Auxiliary	0.175	4.450
1x4 Auxiliary	0.140	3.600
Operating Temperature ²		
	°F	°C
SBO® and SBE® Housings	-4° to 221°	-20° to 105°
Mating Cycles No Load by Plating		
	Silver (Ag)	Gold (Au)
Power Contacts	10,000	
Powerpole® Auxiliary	10,000	
1x4 Auxiliary		10,000
PPMX Auxiliary		5,000
Avg. Mating / Unmating Force		
	Lbf.	N
Main Connector Housing	16	70
Per Powerpole®	5	22
Per Contact in 1x4 Auxiliary	0.7	3.0
Per PPMX Housing	4.50	20.00
Min. Contact / Spring Retention Force		
	Lbf.	N
Power Standard Housing	50	222
Powerpole® Housing	25	111
1x4 Auxiliary Housing	10	44.5
PPMX Housing	12	53

Protection

Touch Safety Main Connector Housing	
IEC 60950	Pass
IEC 60529	IP20

¹ Based on: 105°C rated or better cable of the largest size, Properly calibrated APP® recommended tooling, and a 25°C ambient temperature. UL rating not to exceed the maximum operating temperature. CSA rating below a 30°C temperature rise.

² Limited by the thermal properties of the connector plastic housing.

³ Use APP® recommended tooling only. Alternate tools may adversely affect the performance of our connectors along with UL and CSA recognition.

⁴ Voltage capability of SBE® housings is identical to SBO®, but derated to meet EN1175-1 requirements.



| SBE®80 / SBO®60 CONNECTOR TEMPERATURE CHARTS |

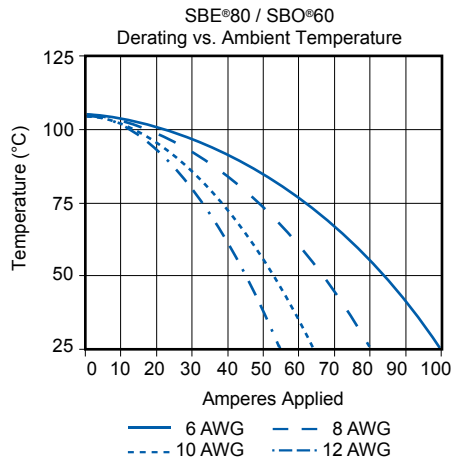
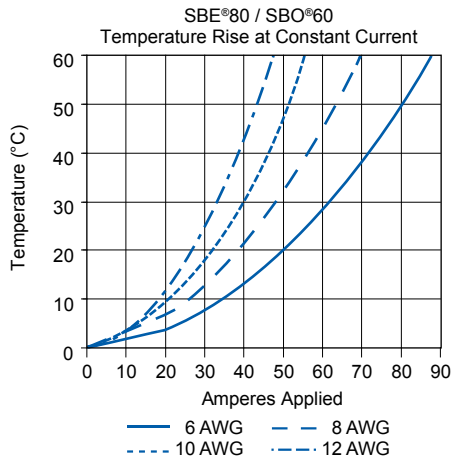

NOTE: Temperature rise charts are based on a 25°C ambient temperature.

| SBE®80 / SBO®60 Accessories |

Cable Clamps

Clamps are made out the same chemical resistant PBT material that is used in the SBE® housings. Clamp holds the cable between the clamp piece and the connector housing. Screws must be ordered separately for part numbers starting with "113".

Description	Part Numbers	
Minimum Quantity	100	25
Red Clamp and Hardware Kit	-	SBE80CLPRED or SBO60CLPRED
Red Clamp Only	113953P1	-
Screws (2 per clamp)	H1120P42 (Individual)	-

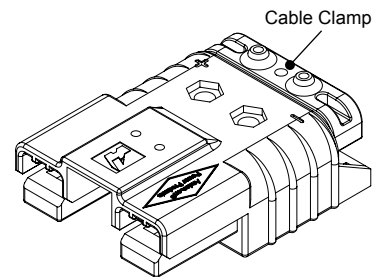

"T" Handle

Handles are made out the same chemical resistant PBT material that is used in the SBE® housings. (2) screws and (2) nuts are required to attach each handle.

Description	Part Numbers		
Minimum Quantity	500	100	25
Red Handle and Hardware Kit	-	-	SBE80HDLRED or SBO60HDLRED
Red Handle Only	113952P1	-	-
Hardware Bag	-	-	105G13
M5 x 35mm Screws	-	113715P4	-
M5 Nut	-	113716P3	-

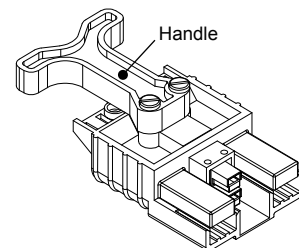

Powerpole® Auxiliary

Powerpole® auxiliary connectors are rated up to 30 amps 600 volts and can be used for auxiliary power, control or sensing. The auxiliary kit includes (1) each black and red Standard Powerpole® housing, (2) contacts, (2) zip cable straps, and (2) retaining pins.

Description	Part Numbers		
Minimum Quantity	200	100	25 ...
Powerpole® Auxiliary Kit	-	111822G1	6344
Black Powerpole® Housing	1327G6	-	-
Red Powerpole® Housing	1327	-	-
#16 to #12 Contact	1331	-	-
Retaining Pin	-	110G9	-

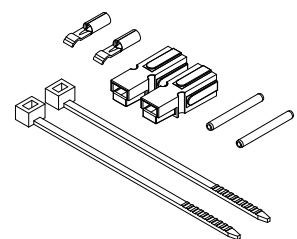

1x4 Auxiliary Connector

APP's unique 1x4 auxiliary connector allows up to 4 auxiliary circuits up to 20 amps 200 volts each in SBE®, SBO®, & SBX® housings. The genderless design holds two each of the gold plated pin & socket contacts. This innovation allows the very durable and cost effective design of SBE®, O, X connectors to substitute for DIN 43589-1 applications where 4 auxiliary contacts are required. Multiple pin lengths allow the further benefit of sequencing between circuits.

- (2) Retaining pins are required to hold the auxiliary housing in place. Auxiliary Kits include (1) Auxiliary Housing, (2) Standard Length Pin Contacts, and (2) Socket Contacts, (2) Retaining Pins and (1) Retaining Clip.

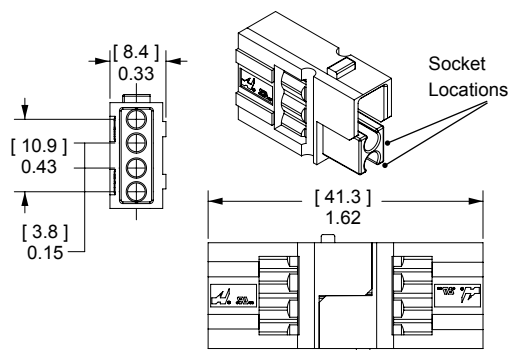

Description	AWG	mm ²	----- Part Numbers -----		
Minimum Quantity			1,000	250	25 ...
1x4 Auxiliary Kit	12	4	-	-	441G1
1x4 Auxiliary Kit	16 to 14	1.5 to 2.5	-	-	441G2
1x4 Auxiliary Kit	20 to 16	0.5 to 1.5	-	-	441G3
1x4 Auxiliary Housing	Contacts Sold Separately		3-5956P1	444G1	-

Pin Contacts for 1x4 Auxiliary Connector

Gold plated contacts are available in 4 lengths to allow sequencing of circuits.

Description	AWG	mm ²	----- Part Numbers -----	
Minimum Quantity			500	50
Standard Length 7.7mm	12	2.5	PM16P12S30	PM16P12S30-50
	16 to 14	1.0 to 1.5	PM16P1416S30	PM16P1416S30-50
	20 to 16	0.75 to 1.0	PM16P1620S30	PM16P1620S30-50
	24 to 20	0.50 to 0.75	PM16P2024S30	PM16P2024S30-50
Pre-Mate 9.3mm	12	2.5	PM16P12A30	PM16P12A30-50
	16 to 14	1.0 to 1.5	PM16P1416A30	PM16P1416A30-50
	20 to 16	0.75 to 1.0	PM16P1620A30	PM16P1620A30-50
	24 to 20	0.50 to 0.75	PM16P2024A30	PM16P2024A30-50
Pre-Mate 8.5mm	12	2.5	PM16P12B30	PM16P12B30-50
	16 to 14	1.0 to 1.5	PM16P1416B30	PM16P1416B30-50
	20 to 16	0.75 to 1.0	PM16P1620B30	PM16P1620B30-50
	24 to 20	0.50 to 0.75	PM16P2024B30	PM16P2024B30-50
Post-Mate 6.4mm	12	2.5	PM16P12C30	PM16P12C30-50
	16 to 14	1.0 to 1.5	PM16P1416C30	PM16P1416C30-50
	20 to 16	0.75 to 1.0	PM16P1620C30	PM16P1620C30-50
	24 to 20	0.50 to 0.75	PM16P2024C30	PM16P2024C30-50

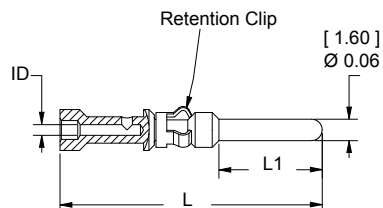

Auxiliary Pin Contact Lengths	- L -		- L1 -	
	in.	mm	in.	mm
Standard Length 7.7mm	0.77	19.6	0.30	7.7
Pre-Mate 9.3mm	0.83	21.2	0.37	9.3
Pre-mate 8.5mm	0.80	20.4	0.33	8.5
Post-Mate 6.6mm	0.72	18.3	0.25	6.4

Socket Contacts for 1x4 Auxiliary Connector

Selectively gold plated contacts offer low resistance and durability up to 10,000 mating cycles.

Description	AWG	mm ²	----- Part Numbers -----	
Minimum Quantity			500	50
Socket Contact	12	2.5	PM16S12S32	PM16S12S32-50
	16 to 14	1.0 to 1.5	PM16S1416S32	PM16S1416S32-50
	20 to 16	0.75 to 1.0	PM16S1620S32	PM16S1620S32-50
	24 to 20	0.50 to 0.75	PM16S2024S32	PM16S2024S32-50

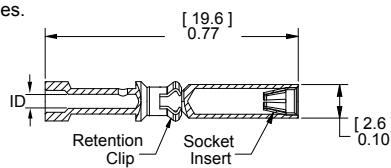

Auxiliary Socket Contacts Crimp Barrel ID		
Wire Gauge	in.	mm.
#24 / 20	0.04	1.1
#20 / 16	0.07	1.7
#16 / 14	0.08	2.1
#12	0.10	2.6

PPMX Auxiliary Connector

The PPMX auxiliary connector allows up to 8 auxiliary circuits to be used in the SBE®, SBO®, & SBX® housings. There are 4 auxiliary circuits per PPMX connector and two PPMX housings fit into the auxiliary port in the main connector housing. Rated up to 7 amps 300 volts per contact, the genderless design holds two each gold plated pin & socket contacts. This innovation allows the very durable and cost effective equipment design of SBE®, O, X connectors to be used for applications requiring up to 8 battery monitoring or vehicle communication circuits. (2) Retaining pins or (1) Retaining clip is required to hold the auxiliary housing in place.

Auxiliary Kits include (1) Auxiliary Housing, (2) Pin Contacts, and (2) Socket Contacts.

Description	AWG	mm ²	----- Part Numbers -----		
Minimum Quantity			1,000	100	25
PPMX Auxiliary Kit	24 to 20	0.50 to 0.25	-	4850G6	-
1x4 Auxiliary Housing	Contacts Sold Separately		4827G6-BK	-	4827G6

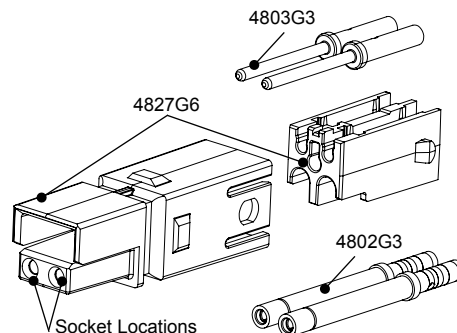

Pin & Socket Contacts for PPMX Auxiliary Connector

Gold plated contacts are ideal for signal or low power use with durability up to 5,000 mating cycles.

Description	AWG	mm ²	----- Part Numbers -----	
Minimum Quantity			2,000	50
Pin Contacts	24 to 20	0.50 to 0.25	4803G3-BK	4803G3
Socket Contacts	24 to 20	0.50 to 0.25	4802G3-BK	4802G3

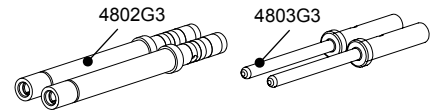

NOTE: Contacts sold individually, not sold as a set of two.

SBE® Air Tubes

Air tubes fit into SBE® housings to allow electrolyte circulation while charging the battery. Genderless tube design allows the same part to be used on both sides. (2) Retaining pins are required to hold the air tube in place. Retaining pins are included in Air Tube Kit.

Description	----- Part Numbers -----	
Minimum Quantity	500	25
Air Tube Kit, Black	-	6396G1
Air Tube Only	3-5798P1	-

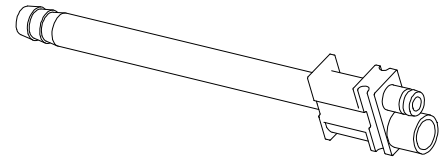

Retaining Pins

Retaining pins are used to hold accessories in the auxiliary port in SBE®, SBO®, & SBX® housings. Dimension "B" is +/- 0.015 in or 0.38 mm.

Description	--- Part Numbers ---		Dimensions			
	1,000	100	- A -		- B -	
			inches	mm	inches	mm
Minimum Quantity	1,000	100				
For SBE®80 & SBO®60	110G9-BK	110G9	0.093 / 0.103	2.36 / 2.62	1.000	38.100

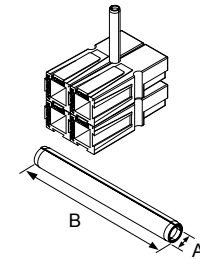

Zip Cable Straps

Zip cable straps are used to secure auxiliary wires to the side of the main power cables.

Description	-- Part Number --
Minimum Quantity	1,000
White	H1835P3

Use cable ties to secure auxiliary contact leads to one of the main cables.

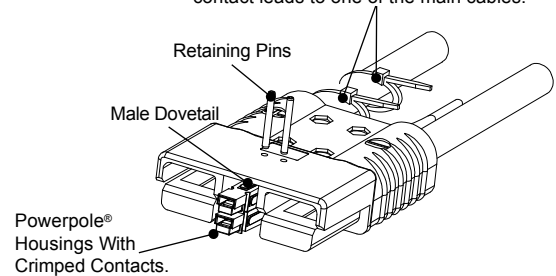

Reducing Bushings

Use with contact part number 1339G1 to allow a smaller wire to be used with the connector. Electrical capability is derated with smaller wire.

Contact Barrel Size	Wire Size	----- Part Numbers -----			Dimensions			
		3,000	1,000	100	- ID -		- Length -	
					inches	mm	Inches	mm
Minimum Quantity		3,000	1,000	100				
#6 AWG [13.3 mm ²]	#8 AWG [8.4 mm ²]	-	5912-BK	5912	0.18	4.57	0.45	11.43
#6 AWG [13.3 mm ²]	#12- 10 AWG [3.3- 5.3 mm ²]	5910-BK	-	5910	0.14	3.56	0.47	11.94
#6 AWG [13.3 mm ²]	#16- 14 AWG [1.3- 2.1 mm ²]	5913-BK	-	5913	0.09	2.29	0.47	11.94

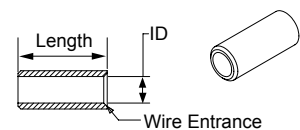

SBE®160 / SBX®175 Connectors - up to 175 Amps



SBX® and SBE® connectors can integrate up to 8 auxiliary power / signal contacts along with the two primary power circuits. SBE® connectors feature an IEC 60950 touch safe housing molded from a chemical resistant PBT/PC blend resin. SBX® are molded from a rugged PC resin and are rated IP20 per IEC 60529.

- Touch Safe Interface**
Minimizes potential contact with live circuits per IEC 60950 & IEC 60529
- Up to 8 Last Mate / First Break Auxiliary's**
Enables intelligent power switching, CAN and interlock loop circuitry, as well as power up to 20 amps per pole
- Color-coded Mechanical Voltage Keys**
Like all Multipole connectors, the SBE® and SBX® offer an easy way to identify circuits and protect against cross mating

| SBE®160 / SBX®175 ORDERING INFORMATION |

SBE®160 / SBX®175 Housings

The middle size of SBE®, X, O style housing. SBE® housings are molded from a chemical resistant PBT. SBX® housings are molded from PC. SBE®160 and SBX®175 housings of the same Voltage Color Code can be mated but is not recommended as it invalidates UL approvals. SBX®175 housings do not meet EN1175-1 requirements for industrial trucks.

Description	Voltage Color Code	- SBE®160 Part Numbers -		- SBX®175 Part Numbers -	
		Code			
Minimum Quantity		100	25	100	25
Yellow	12V	2-8170G4	E6383G1	2-7251G4	6383G1
Orange	18V	2-8170G3	E6382G1	2-7251G3	6382G1
Red	24V	2-8170G5	E6385G1	2-7251G5	6385G1
Gray	36V	2-8170G1	E6380G1	2-7251G1	6380G1
Blue	48V	2-8170G2	E6381G1	2-7251G2	6381G1
Green	72V	2-8170G7	E6390G1	2-7251G7	6390G1
Black	80V	2-8170G14	E6392G1	N/A	N/A

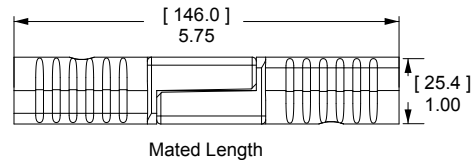
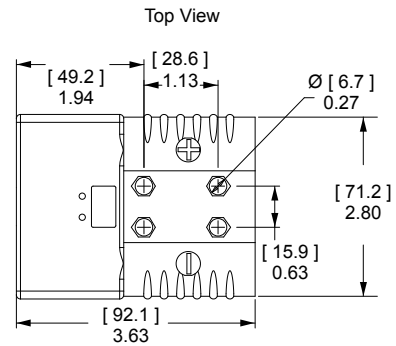

SBE®160 / SB®175 Silver Plated Primary Power Wire Contacts

Use two silver plated contacts per housing for the best electrical performance and durability up to 10,000 mating cycles.

AWG	mm ²	- Loose Piece Part Numbers -		Dimensions - A -	
				inches	mm
Minimum Quantity		500	50		
1/0	50	6384G1-BK	6384G1	0.44	11.1
2	35	6384G2-BK	6384G2	0.38	9.7

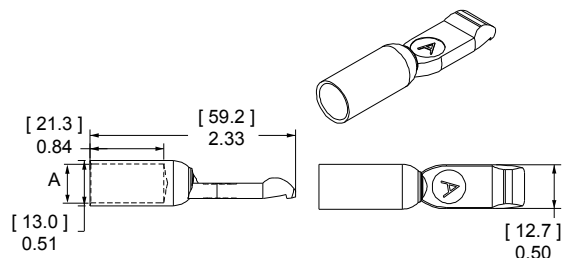

| SBE®160 / SBX®175 CONNECTOR SPECIFICATIONS |

Electrical

Current Rating Amperes ¹	SBX175	SBE160
Primary Power (1/0 AWG)	175	160
Powerpole® Auxiliary (12 AWG)	20	20
1x4 Auxiliary (12 AWG)	20	20
PPMX Auxiliary (20 AWG)	7 UL	5 CSA
Voltage Rating AC/DC		
	UL 1977	EN1175-1
Primary Power	600	150 ⁴
Powerpole® Auxiliary	600	150 ⁴
1x4 Auxiliary	200	
PPMX Auxiliary	300	
Dielectric Withstanding Voltage Primary Power		
Volts AC	2,200	
Avg. Mated Contact Resistance Milliohms¹		
6" of 1/0 AWG wire	0.100	
UL Hot Plug Current Rating Amperes - 250 cycles at 120V DC		
Power	75A	
Powerpole® Auxiliary	30A	
1x4 Auxiliary	5A	

Materials

Housing	
SBX® and Powerpole® Plastic Resin	Polycarbonate
SBE® and 1x4 Auxiliary Housing	Polycarbonate / PBT blend
Contact Retention Spring	Stainless Steel
Housing Flammability Rating	
UL94	V-0
Power & Powerpole® Contact	Silver Plated Copper Alloy
1x4 Auxiliary Contacts	
Pin	Copper alloy, Au over Ni
Socket	BeCu, Au over Ni
Socket Body	Copper alloy, Sn bright over Ni
Retention Clip	Stainless Steel
PPMX Contacts	Gold Plated Copper Alloy
Contact Termination Methods	
Crimp ³	
Hand Solder	

Mechanical

Wire Size Range	AWG	mm ²
Power Contacts	10 to 1/0	5.3 to 53.5
Auxiliary Contacts	24 to 10	0.25 to 5.3
Max. Wire Insulation Diameter		
	in.	mm
Power Contacts	0.440	11.200
Powerpole® Auxiliary	0.175	4.450
1x4 Auxiliary	0.140	3.600
Operating Temperature²		
SBX® and SBE® Housings	-4° to 221°	-20° to 105°
Mating Cycles No Load by Plating		
	Silver (Ag)	Gold (Au)
Power Contacts	10,000	
Powerpole® Auxiliary	10,000	
1x4 Auxiliary		10,000
PPMX Auxiliary		5,000
Avg. Mating / Unmating Force		
	Lbf.	N
Main Connector Housing	30	134
Per Powerpole®	5.00	22.00
Per Contact in 1x4 Auxiliary	0.70	3.00
Per PPMX Housing	4.50	20.00
Min. Contact / Spring Retention Force		
	Lbf.	N
Power Standard Housing	120	533.7
Powerpole® Housing	25	111
1x4 Auxiliary Housing	10	44.5
PPMX Housing	12	53

Protection

Touch Safety Main Connector Housing	
IEC 60950 SBE®160 Only	Pass
IEC 60529 SBX®175 Only	IP20

¹ Based on: 105°C rated or better cable of the largest size, Properly calibrated APP® recommended tooling, and a 25°C ambient temperature. UL rating not to exceed the maximum operating temperature. CSA rating below a 30°C temperature rise.

² Limited by the thermal properties of the connector plastic housing.

³ Use APP® recommended tooling only. Alternate tools may adversely affect the performance of our connectors along with UL and CSA recognition.

⁴ Voltage capability of SBE® housing is identical to SBX®, but derated to meet EN1175-1 requirements.



| SBE®160 / SBX®175 CONNECTOR TEMPERATURE CHARTS|

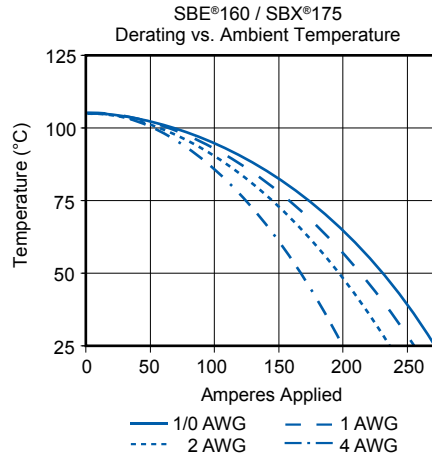
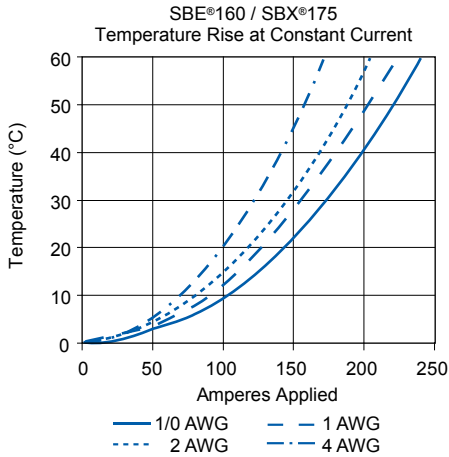

NOTE: Temperature rise charts are based on a 25°C ambient temperature.

| SBE®160 / SBX®175 Accessories |

Cable Clamps

Durable metal clamps adapt to a wide range of cable sizes.

Description	Cable Size		- Part Number -
	Min / Max Inches O.D.	Min / Max mm O.D.	
Minimum Quantity			25
Cable Clamp Kit	0.62 to 0.22	15.7 to 5.6	945G2

The given wire O.D. information is an estimate. Cable clamps should be evaluated for performance with the actual wire to be used.

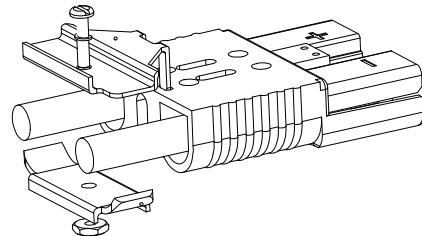

Handles

Handles are made out of durable PC plastic. Hardware to attach to connector body included in kits.

Description	----- Part Numbers -----	
Minimum Quantity	100	25 ..
Gray Handle Kit	995G1-APP	995G1
Red Handle Kit	995G3-APP	995G3
Handle Only, Gray	3-5074P1	-
Handle Only, Red	3-5074P3	-
Handle Only, Black	3-5074P5	-
Hardware Bag	-	105G8

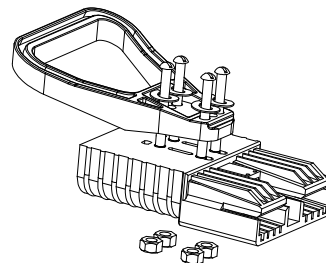

Powerpole® Auxiliary

Powerpole® auxiliary connectors are rated up to 30 amps 600 volts and can be used for auxiliary power, control or sensing. The auxiliary kit includes (1) each black and red Standard Powerpole® housing, (2) contacts, (2) zip cable straps, and (2) retaining pins. (1) Retaining clip can be substituted for (2) retaining pins.

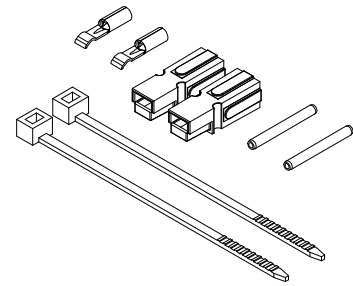

Description	----- Part Numbers -----		
Minimum Quantity	200	100	25 ...
Powerpole® Auxiliary Kit	-	111822G1	6344
Black Powerpole® Housing	1327G6	-	-
Red Powerpole® Housing	1327	-	-
#16 to #12 Contact	1331	-	-

1x4 Auxiliary Connector

APP®'s unique 1x4 auxiliary connector allows up to 4 auxiliary circuits up to 20 amps 150 volts each in SBE®, SBO®, & SBX® housings. The genderless design holds two each of the gold plated pin & socket contacts. This innovation allows the very durable and cost effective design of SBE®, O, X connectors to substitute for DIN 43589-1 applications where 4 auxiliary contacts are required. Multiple pin lengths allow the further benefit of sequencing between circuits. (2) Retaining pins or (1) Retaining clip is required to hold the auxiliary housing in place. Auxiliary Kits include (1) Auxiliary Housing, (2) Standard Length Pin Contacts, (2) Socket Contacts, (2) Retaining Pins and (1) Retaining Clip.

Description	AWG	mm ²	----- Part Numbers -----		
Minimum Quantity			1,000	250	25 ...
1x4 Auxiliary Kit	12	4	-	-	441G1
1x4 Auxiliary Kit	16 to 14	1.5 to 2.5	-	-	441G2
1x4 Auxiliary Kit	20 to 16	0.5 to 1.5	-	-	441G3
1x4 Auxiliary Housing	Contacts Sold Separately		3-5956P1	444G1	-

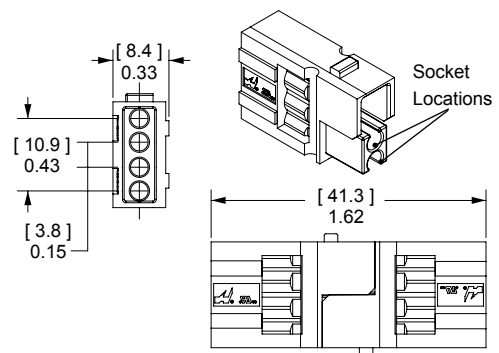

Pin Contacts for 1x4 Auxiliary Connector

Gold plated contacts are available in 4 lengths to allow sequencing of circuits.

Description	AWG	mm ²	----- Part Numbers -----	
Minimum Quantity			500	50
Standard Length 7.7mm	12	2.5	PM16P12S30	PM16P12S30-50
	16 to 14	1.0 to 1.5	PM16P1416S30	PM16P1416S30-50
	20 to 16	0.75 to 1.0	PM16P1620S30	PM16P1620S30-50
	24 to 20	0.50 to 0.75	PM16P2024S30	PM16P2024S30-50
Pre-Mate 9.3mm	12	2.5	PM16P12A30	PM16P12A30-50
	16 to 14	1.0 to 1.5	PM16P1416A30	PM16P1416A30-50
	20 to 16	0.75 to 1.0	PM16P1620A30	PM16P1620A30-50
	24 to 20	0.50 to 0.75	PM16P2024A30	PM16P2024A30-50
Pre-Mate 8.5mm	12	2.5	PM16P12B30	PM16P12B30-50
	16 to 14	1.0 to 1.5	PM16P1416B30	PM16P1416B30-50
	20 to 16	0.75 to 1.0	PM16P1620B30	PM16P1620B30-50
	24 to 20	0.50 to 0.75	PM16P2024B30	PM16P2024B30-50
Post-Mate 6.4mm	12	2.5	PM16P12C30	PM16P12C30-50
	16 to 14	1.0 to 1.5	PM16P1416C30	PM16P1416C30-50
	20 to 16	0.75 to 1.0	PM16P1620C30	PM16P1620C30-50
	24 to 20	0.50 to 0.75	PM16P2024C30	PM16P2024C30-50

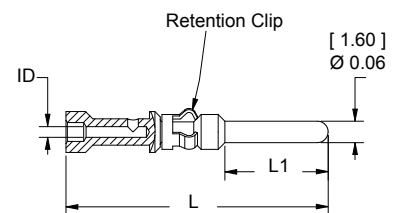

Auxiliary Pin Contact Lengths	- L -		- L1 -	
	in.	mm	in.	mm
Standard Length 7.7mm	0.77	19.6	0.30	7.7
Pre-Mate 9.3mm	0.83	21.2	0.37	9.3
Pre-mate 8.5mm	0.80	20.4	0.33	8.5
Post-Mate 6.6mm	0.72	18.3	0.25	6.4

Socket Contacts for 1x4 Auxiliary Connector

Selectively gold plated contacts offer low resistance and durability up to 10,000 mating cycles.

Description	AWG	mm ²	----- Part Numbers -----	
Minimum Quantity			500	50
Socket Contact	12	2.5	PM16S12S32	PM16S12S32-50
	16 to 14	1.0 to 1.5	PM16S1416S32	PM16S1416S32-50
	20 to 16	0.75 to 1.0	PM16S1620S32	PM16S1620S32-50
	24 to 20	0.50 to 0.75	PM16S2024S32	PM16S2024S32-50

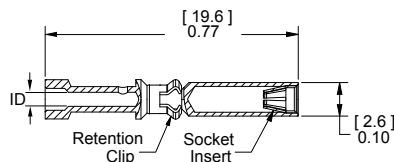

Auxiliary Socket Contacts Crimp Barrel ID		
Wire Gauge	in.	mm.
#24 / 20	0.04	1.1
#20 / 16	0.07	1.7
#16 / 14	0.08	2.1
#12	0.10	2.6

PPMX Auxiliary Connector

The PPMX auxiliary connector allows up to 8 auxiliary circuits to be used in the SBE®, SBO®, & SBX® housings. There are 4 auxiliary circuits per PPMX connector and two PPMX housings fit into the auxiliary port in the main connector housing. Rated up to 7 amps 300 volts per contact, the genderless design holds two each gold plated pin & socket contacts. This innovation allows the very durable and cost effective design of SBE®, O, X connectors to be used for applications requiring up to 8 battery monitoring or equipment vehicle communication circuits. (2) Retaining pins or (1) Retaining clip is required to hold the auxiliary housing in place.

Auxiliary Kits includes: (1) Auxiliary Housing, (2) Pin Contacts, and (2) Socket Contacts.

Description	AWG	mm ²	----- Part Numbers -----		
Minimum Quantity			1,000	100	25
PPMX Auxiliary Kit	24 to 20	0.50 to 0.25	-	4850G6	-
1x4 Auxiliary Housing	Contacts Sold Separately		4827G6-BK	-	4827G6

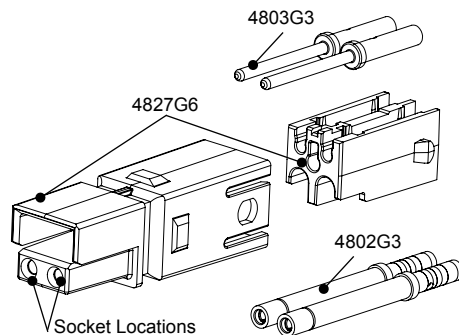

Pin & Socket Contacts for PPMX Auxiliary Connector

Gold plated contacts are ideal for signal or low power use with durability up to 5,000 mating cycles.

Description	AWG	mm ²	----- Part Numbers -----	
Minimum Quantity			2,000	50
Pin Contacts	24 to 20	0.50 to 0.25	4803G3-BK	4803G3
Socket Contacts	24 to 20	0.50 to 0.25	4802G3-BK	4802G3

SBE® Air Tubes

Air tubes fit into SBE® housings to allow electrolyte circulation while charging the battery. Genderless tube design allows the same part to be used on both sides. (2) Retaining pins or (1) Retaining clip is required to hold the air tube in place. Retaining pins are included in Air Tube Kit.

Description	----- Part Numbers -----	
Minimum Quantity	500	25
Air Tube Kit, Black	-	6396G1
Air Tube Only	3-5798P1	-

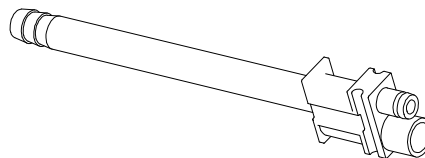

Retaining Clip

Retaining clips can be used in place of two retaining pins to hold auxiliary connectors or air tubes. Allows easier removal of auxiliary modules.

Description	- Part Number -
Minimum Quantity	100
For SBE®160 & SBX®175	2-8675P2

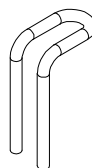

Retaining Pins

Retaining pins are used to hold accessories in the auxiliary port in SBE®, SBO®, & SBX® housings. Dimension "B" is +/- 0.015 in or 0.38 mm.

Description	--- Part Numbers ---		Dimensions			
			- A -		- B -	
			inches	mm	inches	mm
Minimum Quantity	1,000	100				
For SBE®160 & SBX®175	110G9-BK	110G9	0.093 / 0.103	2.36 / 2.62	1.000	38.100

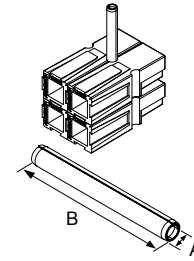

Zip Cable Straps

Zip cable straps are used to secure auxiliary wires to the side of the main power cables.

Description	- Part Number -
Minimum Quantity ..	1,000
White	H1835P3

Use cable ties to secure auxiliary contact leads to one of the main cables.

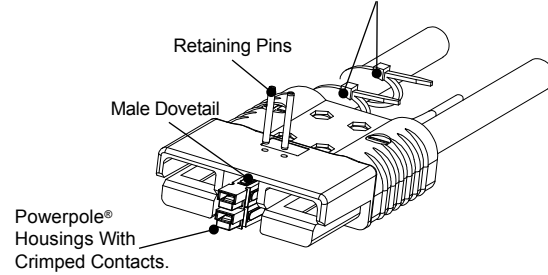

Manual Release - Battery Side

Works with the Charger / Truck side to ease mating and unmating connectors.

Description	--- Part Numbers ---	
Minimum Quantity	88	25 ...
Bracket and Hardware Kit	-	993G2
Battery Bracket Only	111961P2	-
Hardware Bag	-	105G1

Manual Release - Charger / Truck Side

Works with the Battery side to ease mating and unmating connectors.

Description	----- Part Numbers -----	
Minimum Quantity	60	25 ...
Bracket and Hardware Kit	-	994G2
Bracket / Lever Only	B00511G2	-
Hardware Bag	-	105G1

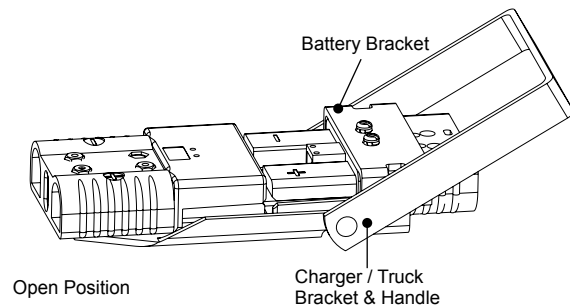

Reducing Bushings: for Use with Contact # 6384G1

Use with contact part number 6384G1-BK to allow a smaller wire to be used with the connector. Electrical capability is derated with smaller wire.

Contacts Barrel Size	Wire Size	----- Part Numbers -----				Dimensions - ID -	
		1,500	1,000	500	100	inches	mm
1/0 AWG [53.5 mm²]	#1 AWG [42.4 mm²]	-	-	5687-BK	5687	0.39	9.91
1/0 AWG [53.5 mm²]	#2 AWG [33.6 mm²]	5690-BK	-	-	5690	0.34	8.64
1/0 AWG [53.5 mm²]	#4 AWG [21.2 mm²]	-	5693-BK	-	5693	0.27	6.86
1/0 AWG [53.5 mm²]	#6 AWG [13.3 mm²]	-	5663-BK	-	5663	0.22	5.59
1/0 AWG [53.5 mm²]	#10 - 8 AWG [5.3 - 8.4 mm²]	5648-BK	-	-	5648	0.19	4.83

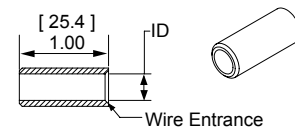

Reducing Bushings: for Use with Contact # 6384G2

Use with contact part number 6384G2-BK to allow a smaller wire to be used with the connector. Electrical capability is derated with smaller wire.

Contact Barrel Size	Wire Size	----- Part Numbers -----	
Minimum Quantity		1,000	100
35 mm²	16 mm²	5920-BK	5920

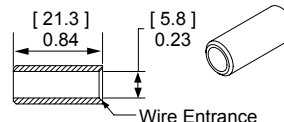

SBE®320 / SBX®350 Connectors

- up to 350 Amps



SBX® and SBE® connectors can integrate up to 8 auxiliary power / signal contacts along with the two primary power circuits. Sequencing within auxiliary positions is possible using the 4 pin lengths available in the 1x4 auxiliary connector. The SBE® touch safety rating is equivalent to that of the SBS® connector line.

- **Silver Plated Wire Contacts up to 300 mcm (152 mm²)**
Allows low resistance UL rated currents up to 350 amps per pole
- **Up to 8 Last-mate / First-break Auxiliary's**
Enables intelligent power switching, CAN and interlock loop circuitry, as well as power up to 20 amps per pole
- **Durable Housings and Contacts**
Like all Multipole connectors, the silver plated power contacts are rated up to 10,000 mating cycles

| SBE®320 / SBX®350 ORDERING INFORMATION |

SBE®320 / SBX®350 Housings

The largest size of SBE®, X, O style housing. SBE® housings are molded from a chemical resistant PBT. SBX® housings are molded from PC. SBE®320 and SBX®350 housings of the same Voltage Color Code cannot be mated. SBX®350 housings do not meet EN1175-1 requirements for industrial trucks.

Description	Voltage Color Code	- SBE®320 Part Numbers -		- SBX®350 Part Numbers -	
		Minimum Quantity	100	25	100
Yellow	12V	2-8171G6	E6362	2-7249G6	6362
Orange	18V	2-8171G7	E6339	2-7249G7	6339
Red	24V	2-8171G3	E6352	2-7249G3	6352
Gray	36V	2-8171G1	E6380G1	2-7249G1	6350
Blue	48V	2-8171G2	E6351	2-7249G2	6351
Green	72V	2-8171G4	E6353	2-7249G4	6353
Black	80V	2-8171G5	E6361	2-7249G5	6361
Brown	96V	2-8171G8	E6336	N/A	N/A
Purple	120V	2-8171G9	E6349	N/A	N/A

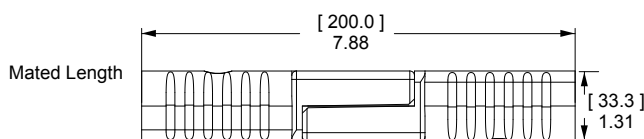
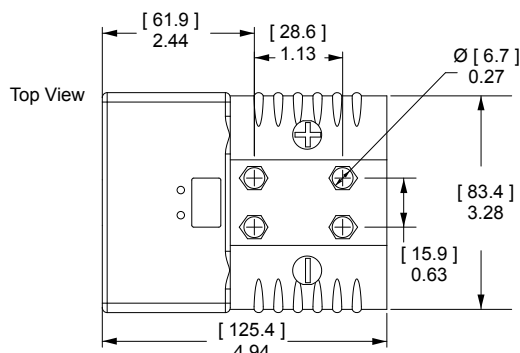

SBE®320 / SBX®350 Silver Plated Primary Power Wire Contacts

Silver plated contacts offer superior electrical performance and durability up to 10,000 mating cycles.

AWG	mm ²	- Loose Piece Part Numbers -		Dimensions								
				- A -		- B -		- C -		- D -		
Minimum Quantity		200	150	50	inches	mm	inches	mm	inches	mm	inches	mm
300 mcm	150	-	6358-BK	6358	3.03	76.96	0.88	22.35	0.75	19.05	0.88	22.35
4/0	120	6356-BK	-	6356	3.10	78.74	0.75	19.05	0.64	16.26	0.81	20.57
3/0	95	6355-BK	-	6355	3.10	78.74	0.70	17.78	0.58	14.73	0.81	20.57
2/0	70	6354-BK	-	6354	3.10	78.74	0.64	16.26	0.49	12.45	0.81	20.57
2	35	6394-BK	-	6394	3.03	76.96	0.51	12.95	0.38	9.65	0.81	20.57

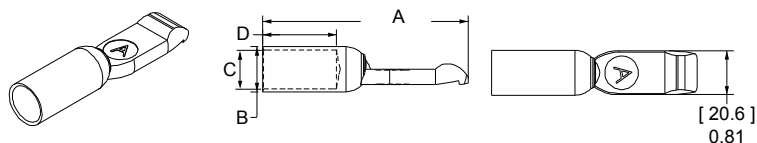

SECTION 3
SBE® 320 / SBX® 350

SBE®320 DIN Standard Silver Plated Primary Power Wire Contacts

Crimp barrel O.D. are compliant with DIN standard tooling. Will also fit into SBX®350 housings. Not recommended for cross mating with above typical contacts for SBE® & SBX®.

AWG	mm ²	Loose Piece ----- Part Numbers -----		Dimensions							
				- A -		- B -		- C -		- D -	
Minimum Quantity ...		200	50	inches	mm	inches	mm	inches	mm	inches	mm
3/0	95	1341G3-BK	1341G3	2.89	73.41	0.78	19.81	0.59	14.99	0.94	23.88
2/0	70	1341G2-BK	1341G2	2.74	69.60	0.68	17.27	0.51	12.95	0.79	20.07
1/0	50	1341G1-BK	1341G1	2.65	67.31	0.57	14.48	0.43	10.92	0.79	20.07

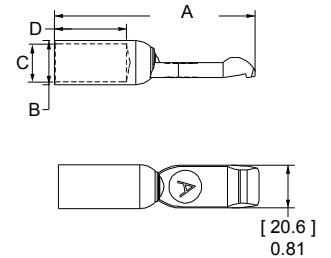

| SBE®320 / SBX®350 CONNECTOR SPECIFICATIONS |

Electrical

Current Rating Amperes¹	SBX350	SBE320
Primary Power (300 mcm)	350	320
Powerpole® Auxiliary (12 AWG)	20	20
1x4 Auxiliary (12 AWG)	20	20
PPMX Auxiliary (20 AWG)	7 UL	5 CSA
Voltage Rating AC/DC	UL 1977	EN1175-1
Primary Power	600	150 ⁴
Powerpole® Auxiliary	600	150 ⁴
1x4 Auxiliary	200	
PPMX Auxiliary	300	
Dielectric Withstanding Voltage Primary Power		
Volts AC	2,200	
Avg. Mated Contact Resistance Milliohms¹		
2 1/2" of 300mcm wire	0.050	
UL Hot Plug Current Rating Amperes - 250 cycles at 120V DC		
Power	100A	
Powerpole® Auxiliary	30A	
1x4 Auxiliary	5A	

Materials

Housing	
SBX® and Powerpole® Plastic Resin	Polycarbonate
SBE® and 1x4 Auxiliary Housing	Polycarbonate / PBT blend
Contact Retention Spring	Stainless Steel
Housing Flammability Rating	
UL94	V-0
Power & Powerpole® Contact	Silver Plated Copper Alloy
1x4 Auxiliary Contacts	
Pin	Copper alloy, Au over Ni
Socket	BeCu, Au over Ni
Socket Body	Copper alloy, Sn bright over Ni
Retention Clip	Stainless Steel
PPMX Contacts	Gold Plated Copper Alloy
Contact Termination Methods	
Crimp ³	
Hand Solder	

Mechanical

Wire Size Range	AWG	mm²
Power Contacts	1/0 to 300 mcm	53.5 to 152
Auxiliary Contacts	24 to 10	0.25 to 5.3
Max. Wire Insulation Diameter	in.	mm
Power Contacts	0.440	11.200
Powerpole® Auxiliary	0.175	4.450
1x4 Auxiliary	0.140	3.600
Operating Temperature²	°F	°C
SBX and SBE Housings	-4° to 221°	-20° to 105°
Mating Cycles No Load by Plating	Silver (Ag)	Gold (Au)
Power Contacts	10,000	
Powerpole® Auxiliary	10,000	
1x4 Auxiliary		10,000
PPMX Auxiliary		5,000
Avg. Mating / Unmating Force	Lbf.	N
Main Connector Housing	55	245
Per Powerpole®	5.00	22.00
Per Contact in 1x4 Auxiliary	0.70	3.00
Per PPMX Housing	4.50	20.00
Min. Contact / Spring Retention Force	Lbf.	N
Power Standard Housing	150	667.2
Powerpole® Housing	25	111
1x4 Auxiliary Housing	10	44.5
PPMX Housing	12	53

Protection

Touch Safety Main Connector Housing

IEC 60950 SBE®320 Only	Pass
IEC 60529 SBE®320 & SBX®350	IP20

¹ Based on: 105°C rated or better cable of the largest size, Properly calibrated APP® recommended tooling, and a 25°C ambient temperature. UL rating not to exceed the maximum operating temperature. CSA rating below a 30°C temperature rise.

² Limited by the thermal properties of the connector plastic housing.

³ Use APP® recommended tooling only. Alternate tools may adversely affect the performance of our connectors along with UL and CSA recognition.

⁴ Voltage capability of SBE® housings is identical to SBX®, but derated to meet EN1175-1 requirements.



| SBE®320 / SBX®350 CONNECTOR TEMPERATURE CHARTS|

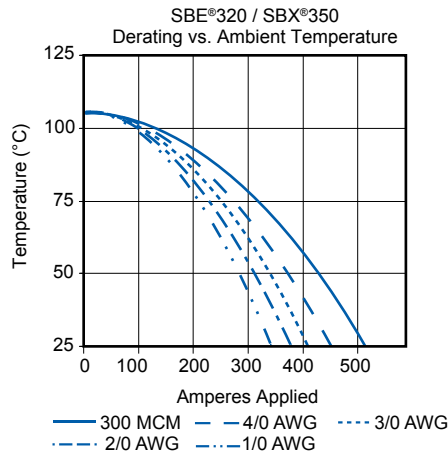
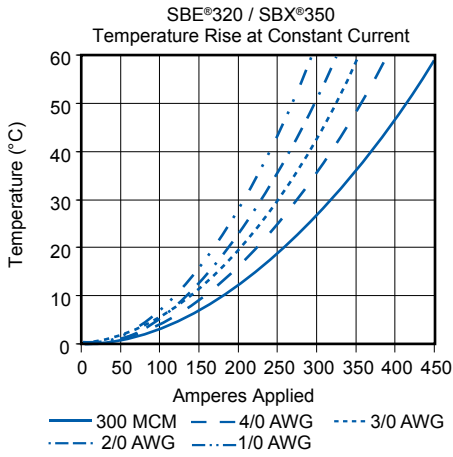

| SBE®320 / SBX®350 Accessories |

Cable Clamps

Durable metal clamps adapt to a wide range of cable sizes. Cable clamp kit includes Clamp Top and Bottom as well as the Hardware Bag.

Description	Cable Size		- Part Number -
	Min / Max Inches O.D.	Min / Max mm O.D.	
Minimum Quantity			25
Cable Clamp Kit	0.85 to 0.67	21.6 to 17.1	911G2

The given wire O.D. information is an estimate. Cable clamps should be evaluated for performance with the actual wire to be used.

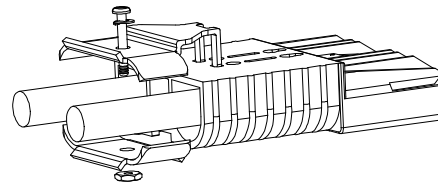

Handles

Handles are made out of durable PC plastic. Hardware to attach to connector body included in kits.

Description	----- Part Numbers -----	
Minimum Quantity	100	25 ...
Gray Handle Kit	995G2-APP	995G2
Red Handle Kit	995G4-APP	995G4
Handle Only, Gray	3-5074P1	-
Handle Only, Red	3-5074P3	-
Handle Only, Black	3-5074P5	-
Hardware Bag	-	106G7

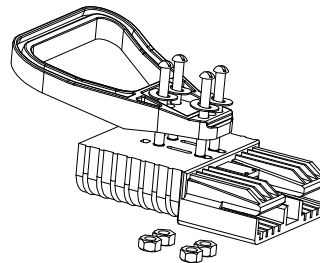

Powerpole® Auxiliary

Powerpole® auxiliary connectors are rated up to 30 amps 600 volts and can be used for auxiliary power, control or sensing. The auxiliary kit includes (1) each black and red Standard Powerpole® housing, (2) contacts, (2) zip cable straps, and (2) retaining pins. (1) Retaining clip can be substituted for (2) retaining pins.

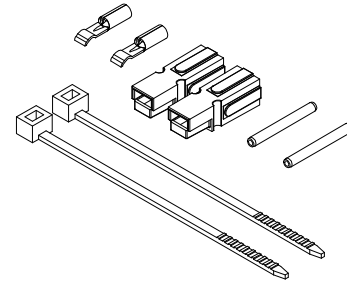

Description	----- Part Numbers -----		
Minimum Quantity	200	100	25 ...
Powerpole® Auxiliary Kit #16 to #12 Contact	-	114360G1	6305G1
Powerpole® Auxiliary Kit #20 to #16 Contact	-	-	6310G1
Black Powerpole® Housing	1327G6	-	-
Red Powerpole® Housing	1327	-	-
#16 to #12 Contact	1331	-	-
#20 to #16 Contact	1332	-	-

1x4 Auxiliary Connector

APP®'s unique 1x4 auxiliary connector allows up to 4 auxiliary circuits up to 20 amps 150 volts each in SBE®, SBO®, & SBX® housings. The genderless design holds two each of the gold plated pin & socket contacts. This innovation allows the very durable and cost effective design of SBE®, O,X connectors to substitute for DIN 43589-1 applications where 4 auxiliary contacts are required. Multiple pin lengths allow the further benefit of sequencing between circuits. (2) Retaining pins or (1) Retaining clip is required to hold the auxiliary housing in place. Auxiliary Kits include (1) Auxiliary Housing, (2) Standard Length Pin Contacts, (2) Socket Contacts, (2) Retaining Pins and (1) Retaining Clip.

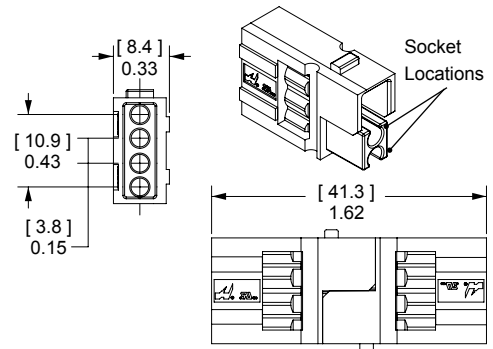

Description	AWG	mm ²	----- Part Numbers -----		
Minimum Quantity			1,000	250	25 ...
1x4 Auxiliary Kit	12	4	-	-	440G1
1x4 Auxiliary Kit	16 to 14	1.5 to 2.5	-	-	440G2
1x4 Auxiliary Kit	20 to 16	0.5 to 1.5	-	-	440G3
1x4 Auxiliary Housing	Contacts Sold Separately		3-5956P1	444G1	-

Pin Contacts for 1x4 Auxiliary Connector

Gold plated contacts are available in 4 lengths to allow sequencing of circuits.

Description	AWG	mm ²	----- Part Numbers -----	
Minimum Quantity			500	50
Standard Length 7.7mm	12	2.5	PM16P12S30	PM16P12S30-50
	16 to 14	1.0 to 1.5	PM16P1416S30	PM16P1416S30-50
	20 to 16	0.75 to 1.0	PM16P1620S30	PM16P1620S30-50
	24 to 20	0.50 to 0.75	PM16P2024S30	PM16P2024S30-50
Pre-Mate 9.3mm	12	2.5	PM16P12A30	PM16P12A30-50
	16 to 14	1.0 to 1.5	PM16P1416A30	PM16P1416A30-50
	20 to 16	0.75 to 1.0	PM16P1620A30	PM16P1620A30-50
	24 to 20	0.50 to 0.75	PM16P2024A30	PM16P2024A30-50
Pre-Mate 8.5mm	12	2.5	PM16P12B30	PM16P12B30-50
	16 to 14	1.0 to 1.5	PM16P1416B30	PM16P1416B30-50
	20 to 16	0.75 to 1.0	PM16P1620B30	PM16P1620B30-50
	24 to 20	0.50 to 0.75	PM16P2024B30	PM16P2024B30-50
Post-Mate 6.4mm	12	2.5	PM16P12C30	PM16P12C30-50
	16 to 14	1.0 to 1.5	PM16P1416C30	PM16P1416C30-50
	20 to 16	0.75 to 1.0	PM16P1620C30	PM16P1620C30-50
	24 to 20	0.50 to 0.75	PM16P2024C30	PM16P2024C30-50

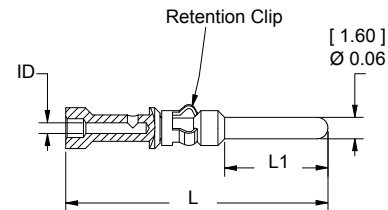

Auxiliary Pin Contact Lengths	- L -		- L1 -	
	in.	mm	in.	mm
Standard Length 7.7mm	0.77	19.6	0.30	7.7
Pre-Mate 9.3mm	0.83	21.2	0.37	9.3
Pre-mate 8.5mm	0.80	20.4	0.33	8.5
Post-Mate 6.6mm	0.72	18.3	0.25	6.4

Socket Contacts for 1x4 Auxiliary Connector

Selectively gold plated contacts offer low resistance and durability up to 10,000 mating cycles.

Description	AWG	mm ²	----- Part Numbers -----	
Minimum Quantity			500	50
Socket Contact	12	2.5	PM16S12S32	PM16S12S32-50
	16 to 14	1.0 to 1.5	PM16S1416S32	PM16S1416S32-50
	20 to 16	0.75 to 1.0	PM16S1620S32	PM16S1620S32-50
	24 to 20	0.50 to 0.75	PM16S2024S32	PM16S2024S32-50

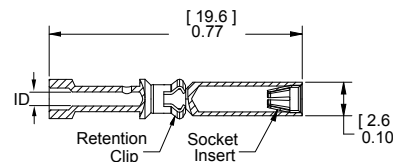

Auxiliary Socket Contacts Crimp Barrel ID		
Wire Gauge	in.	mm.
#24 / 20	0.04	1.1
#20 / 16	0.07	1.7
#16 / 14	0.08	2.1
#12	0.10	2.6

SBE® Air Tubes

Air tubes fit into SBE® housings to allow electrolyte circulation while charging the battery. Genderless tube design allows the same part to be used on both sides. (2) Retaining pins or (1) Retaining clip is required to hold the air tube in place. Retaining pins are included in Air Tube Kit.

Description	---- Part Numbers ----	
Minimum Quantity	500	25 ...
Air Tube Kit, Black	-	6396G1
Air Tube Only	3-5798P1	-

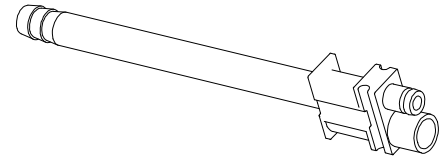

PPMX Auxiliary Connector

The PPMX auxiliary connector allows up to 8 auxiliary circuits to be used in the SBE®, SBO®, & SBX® housings. There are 4 auxiliary circuits per PPMX connector and two PPMX housings fit into the auxiliary port in the main connector housing. Rated up to 7 amps 300 volts per contact, the genderless design holds two each gold plated pin & socket contacts. This innovation allows the very durable and cost effective design of SBE®, O, X connectors to be used for applications requiring up to 8 battery monitoring or equipment vehicle communication circuits. (2) Retaining pins or (1) Retaining clip is required to hold the auxiliary housing in place.

Auxiliary Kits includes: (1) Auxiliary Housing, (2) Pin Contacts, and (2) Socket Contacts.

Description	AWG	mm ²	----- Part Numbers -----		
Minimum Quantity			1,000	100	25
PPMX Auxiliary Kit	24 to 20	0.50 to 0.25	-	4850G6	-
1x4 Auxiliary Housing	Contacts Sold Separately		4827G6-BK	-	4827G6

Pin & Socket Contacts for PPMX Auxiliary Connector

Gold plated contacts are ideal for signal or low power use with durability up to 5,000 mating cycles.

Description	AWG	mm ²	----- Part Numbers -----	
Minimum Quantity			2,000	50 ...
Pin Contacts	24 to 20	0.50 to 0.25	4803G3-BK	4803G3
Socket Contacts	24 to 20	0.50 to 0.25	4802G3-BK	4802G3

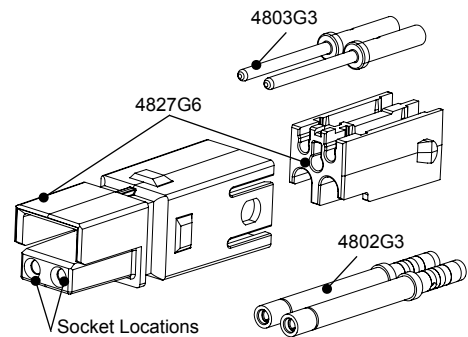

Retaining Clip

Retaining clips can be used in place of two retaining pins to hold auxiliary connectors or air tubes. Allows easier removal of auxiliary modules.

Description	-- Part Number --
Minimum Quantity	100
For SBE®320 & SBX®350	2-8675P1

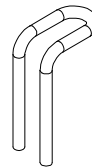

Retaining Pins

Retaining pins are used to hold accessories in the auxiliary port in SBE®, SBO®, & SBX® housings. Dimension "B" is +/- 0.015 in or 0.38 mm.

Description	- Part Number -	Dimensions			
		- A -		- B -	
		inches	mm	inches	mm
Minimum Quantity	1,000				
For SBE®320 & SBX®350	110G59-BK	0.093 / 0.103	2.36 / 2.62	1.000	38.100

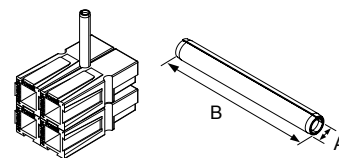

Zip Cable Straps

Zip cable straps are used to secure auxiliary wires to the side of the main power cables.

Description	--- Part Number ---
Minimum Quantity	1,000
White	H1835P3

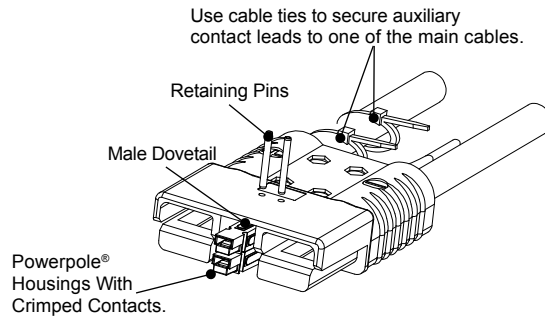

Manual Release - Battery Side

Works with the Charger / Truck side to ease mating and unmating connectors.

Description	---- Part Numbers ---
Minimum Quantity	72 25
Bracket and Hardware Kit	- 993G1
Battery Bracket Only	111961P1 -
Hardware Bag	- 106G6

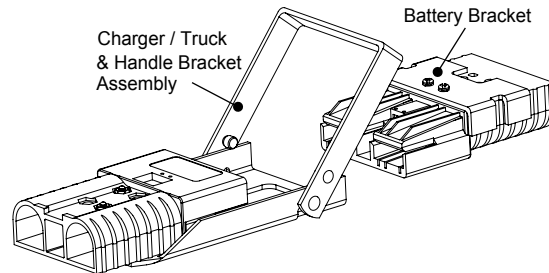

Manual Release - Charger/ Truck Side

Works with the Battery side to ease mating and unmating connectors.

Description	- Part Numbers -
Minimum Quantity	25
Bracket and Hardware Kit	994G1
Bracket / Lever Only	B00511G4
Hardware Bag	106G6

Reducing Bushings: for Use with Contact # 6354 and Bushing # 5918

Use with contact part number 6354-BK and bushing part number 5918-BK to allow a smaller wire to be used with the connector. Electrical capability is derated with smaller wire.

Bushings # 5918 Barrel Size Wire Size	----- Part Numbers -----				Dimensions - ID -	
	1,500	1,000	500	100	inches	mm
Minimum Quantity	1,500	1,000	500	100		
1/0 AWG [53.5 mm²] #1 AWG [42.4 mm²]	-	-	5687-BK	5687	0.39	9.91
1/0 AWG [53.5 mm²] #2 AWG [33.6 mm²]	5690-BK	-	-	5690	0.34	8.64
1/0 AWG [53.5 mm²] #4 AWG [21.2 mm²]	-	5693-BK	-	5693	0.27	6.86
1/0 AWG [53.5 mm²] #6 AWG [13.3 mm²]	-	5663-BK	-	5663	0.22	5.59
1/0 AWG [53.5 mm²] #10 - 8 AWG [5.3 - 8.4 mm²]	5648-BK	-	-	5648	0.19	4.83

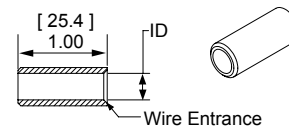

Reducing Bushings: for Use with Contact # 6354

Use with contact part number 6354-BK to allow a smaller wire to be used with the connector. Electrical capability is derated with smaller wire.

Contact Barrel Size Wire Size	--- Part Number ---
Minimum Quantity	500 100 ...
2/0 AWG [67.4 mm²] 1/0 AWG [53.5 mm²]	5918-BK 5918

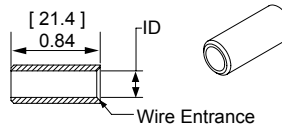

Reducing Bushings: for Use with Contact # 6394

Use with contact part number 6394-BK to allow a smaller wire to be used with the connector. Electrical capability is derated with smaller wire.

Contact Barrel Size Wire Size	-- Part Numbers --	Dimensions - ID -	
		inches	mm
Minimum Quantity	1,000 100		
35 mm² 16 mm²	5920-BK 5920	0.23	5.8

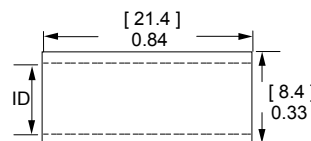

SBO® / SBE® / SBX®

- Tooling Information

Wire Size		Loose Piece Part Numbers	Loose Piece Contact Crimp Tool				
AWG	mm ²	Contacts	Pneumatic Bench Tool	+ Die	+ Locator	Number of Crimps	or Hand Tool
SBE 320 / SBX 350							
300 MCM	152	6358	N/A	N/A	N/A	N/A	1368
4/0 AWG	107.2	6356	1387G2	1303G12	1304G28	Double	
3/0 AWG	85	6355					
2/0 AWG	67.4	6354					
N/A	95 mm ²	1341G3	1387G2	1303G17	1304G35	Double	
N/A	70 mm ²	1341G2		1303G12	1304G34		
N/A	50 mm ²	1341G1		1303G8	1304G36		
SBE 160 / SBX 175							
1/0 AWG	53.5	6384G1	1387G2	1303G2	1304G2	Single	1368
#2	35 mm ²	6384G2	1387G1	1388G3	1389G3		
			1387G2	1303G2	1304G2		
SBO 60 / SBE 80							
#4	25	1339G4	1387G1	1388G7	1389G9	Single	N/A
#6	16	1339G1		1388G6			1309G4
Powerpole 15/45 Auxiliary Contacts **							
#16 / 20	1.3 / .52	1332	1367G1	N/A	N/A	Single	1309G2 or 1309G8
#12 / 16	3.3 / 1.3	1331					
PowerMod 1x4 Auxiliary Contacts							
#12 / 24	2.5 / .25	All Crimp Pins	TP0001*	N/A	TL0001	Single	TM0001*
		All Crimp Sockets			TL0002		PM1000G1
PPMX Auxiliary Contacts							
#20 / 24	0.50 / 0.25	4803G3	TP0001*	N/A	TL0005	Single	TM0001* or
		4802G3					PM1000G1

* TP0001 and TM0001 tools require locators to properly position contacts.

** See Powerpole® family tooling chart for other Powerpole® contacts

NOTE: See website for the most current information.

APP® Tooling

Why Use of APP® Recommended Crimp Tooling is so Important

APP® connectors are designed to achieve the highest levels of durability, reliability, and performance as shown on the connector data sheets. Crimp tooling is a critical link between the designed performance of an APP® connector and the realization of that performance by our customers.

As part of the connector design and testing process, APP® recommends a limited number of crimp solutions that have proven to deliver the intended connector performance in a process that is repeatable. Only these solutions tested by APP® are listed in the conditions of acceptability from safety agencies such as UL, CSA, and TUV.











Use of tooling solutions not tested by APP® can affect not only performance but safety agency approvals. Problems attributable to use of tools not recommended by APP® include:

Electrical and Thermal

- High electrical resistance
- Failure to realize designed current and voltage carrying capability
- Overheating
- Melting of connector housings

Mechanical

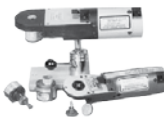
- Contacts not able to fit inside connector housings.
- Contacts not seated properly in connector housings causing: shorts, intermittent circuits, abnormally high or low mating and unmating force, & low retention force of the contact in the housing.

	PP15-45	SB®50 & PP75	SBS®	PP120, PP180, SB®, SBE®, SBX® & SBO®
<i>Detail tooling charts are available at the end of each connector family (Powerpole®, SB®, etc.).</i>				
 ATS Applicators	●	●		● SBE®, SBX® & SBO® Auxiliary
 1309 Series	●	●	●	● SBE®, SBX® & SBO® Auxiliary
 PM1000G1			● SBS®75 Auxiliary	● SBE®, SBX® & SBO® Auxiliary
 TM0001			● SBS®75 Auxiliary	● SBE®, SBX® & SBO® Auxiliary
 TP0001			● SBS®75 Auxiliary	● SBE®, SBX® & SBO® Auxiliary
 1387G1 & 1387G2		●	●	●
 1368				●

| 1387G1 & G2 Pneumatic Bench Tools |

Versatile & heavy duty tools manufactured by Pico Tools, use fixed depth dies and spring bottom locators designed specifically to crimp APP® contacts. Dies and locators are not interchangeable between the 1387G1 and the 1387G2. These pneumatic full cycle tools operate on clean and dry shop air pressures of 80 – 125 psi (5 – 8.6 BAR). See connector family tooling charts at the end of each section for the specific dies and locators recommended for crimping each contact. Dies and locators are available from Pico Tools for a variety of other terminal types including lugs, insulated terminals, and a variety of turned pin and socket contacts.

1387G1: #12 – 2/0 (4 – 70 mm²)
Pico Tools Model 400-BHD
Compatible with M22520/23
dies and locators

1387G2: #12 – 250 mcm (4 – 120 mm²)
Pico Tools Model: 500-D



1391G1: Foot Pedal Control

TA0002: Air regulator / filter for pneumatic tools.
Keeps air clean and dry for long lasting tool performance. Dial knob adjusts air pressure going to the tool.



| 1368 Series Hydraulic Tools |

The dieless 4 indent head crimps full cycle until a minimum hydraulic pressure is reached. Good for crimping nearly all APP® contacts for wire sizes #4 – 4/0, 300mcm. The dieless system offers a highly flexible crimping system that does not require the purchase of separate dies and locators. Pressure based crimp depth allows these tools to be adapted to a broad range of large wire crimping needs including lugs, ring terminals, and splices.

1368: Hubbell VC7 dieless 4 indent tool with attached manual hydraulic pump. Tool includes a custom turret locator for positioning of PP120, PP180, SB®120, SB®175, SB®350 contacts. The innovative design provides two separate crimp positions for the PP180, SB®175 and SB®350 contacts. Both the tool and locator ship in black plastic carrying cases.

1368-NL: Manufactured by DMC to APP® specifications, this 4 indent head with attached manual hydraulic pump offers the same crimping performance as the 1368, but with the cost savings of not having a custom turret locator. Includes black plastic carrying case.

1368-B: The same 4 indent head as the 1368-NL is mounted to a battery powered tool for effortless crimping. Includes 2 lithium-ion batteries and charger as well as a black plastic carrying case.



| 1309 Series Hand Tools |

High quality hand tools are designed for crimping #6 – 20 AWG (13.3 – 0.52 mm²) wires for Powerpole®, SB®, SBS®, and SBE® / SBO® connectors. The extra long bright yellow handles provide significant crimping force while minimizing operator fatigue. Full cycle ratchet mechanism makes sure every crimp is fully completed. All tools except 1309G4 include a plastic locator piece that ensures proper positioning of the contacts for crimping.

1309G2: For crimping PP15/45 loose piece strip contacts and individual contacts.
#16 – 20 AWG (1.3 – 0.5 mm²)
#12 – 20 AWG (3.3 – 1.3 mm²)

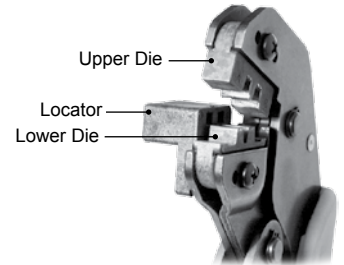

1309G3: For crimping PP15/45 loose piece strip contacts from #10 – 16 AWG (5.3 – 1.3 mm²)

1309G6: For crimping PP15/45 loose piece strip contacts from #10 – 14 AWG (6.0 – 2.1 mm²) including high strand count superflex wires.

1309G8: Includes 1 tool frame with the appropriate dies and locators to make the 1309G2, 1309G3, and 1309G6 tools. Dies and locators are color coded for easy identification and pairing. This combination allows the entire PP15/45 contact range to be crimped with one tool kit.

Open Barrel Contact

End of locator.



Correct

To far out from locator.

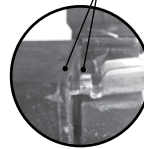

Not Correct

Closed Barrel Contact

End of locator.



Correct

To far out from locator.

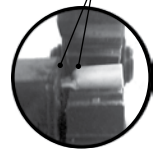

Not Correct

1309G4: For crimping PP75, SB®50, SBE®80, SBO®60, and SBS®50-75 power contacts. No locator included, follow crimp positioning specifications in assembly instructions. Tool is also used for crimping EBC auxiliary contacts.

| PM1000G1 Hand Tool |

Versatile 4 indent hand tool with built in multi-position turret locator. Adjustable indenter depth features 0.01 mm adjustment increments to define the perfect crimp depth for wire sizes 10 – 26 AWG (6 – 0.14 mm²). Full cycle ratchet mechanism makes sure every crimp is fully completed. Use to crimp PowerMod® contacts used as auxiliaries in SBS®75X and the 1x4 Auxiliary Connector as well as a wide range of other turned contacts including those for Power Drawer® and PPMX.



| Mil-Spec Hand & Bench Tools |

Manual hand tools and pneumatic bench tools are available in this tool series. The hand and pneumatic tools both use the same turret locators designed specifically for APP® contacts. The interchangeable nature of the turret locators allow easy upgrades from prototyping to production volumes. All tools feature adjustable indenter depths to cover #12 through 26 AWG (3.3 – 0.25 mm²) capability. Full cycle mechanism makes sure every crimp is fully completed. See tooling charts at the end of each connector section for the appropriate turret locator part numbers.

TM0001: Rugged hand tool is qualified to MIL-DTL-22520/1. DMC Model AF8. Accessories shown are purchased separately.

TP0001: Pneumatic full cycle bench tool operates on clean and dry shop air pressures of 80 – 120 psi (5 – 8.3 BAR). This DMC model WA27F is compatible with optional bench mount and foot pedal control to increase operator speed and efficiency.

TA0001: Foot pedal control for TP0001

TA0002: Air regulator / filter for pneumatic tools. Keeps air clean and dry for long lasting tool performance. Dial knob adjusts air pressure going to the tool.

TA0003: Adjustable bench mount for TP0001



TA0002

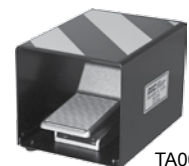

TA0001



TM0001

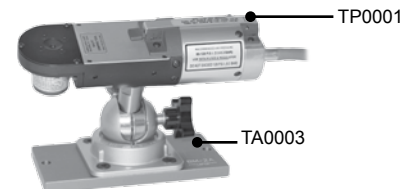

TP0001

TA0003

| Press and Applicator Tools |

Anderson Power Products®, in partnership with Application Tooling Solutions, has engineered a line of application tooling for APP®'s reeled contacts. All applicators have been designed to meet or exceed UL requirements. See connector family tooling charts at the end of each section for the specific press, air feed kit, and applicator recommended for crimping each contact.

- **Designed Specifically For APP® Contacts**
Provides crimps that meet or exceed UL requirements
- **World-Wide On-Site Service**
Provided through ATS's extensive field service network
- **Mini-Style Applicators Can Be Adapted To Most Existing Presses**
AMP, K & T presses, Kenco presses, and most other manufacturers
- **Contact ATS Directly to Purchase or Lease Tooling**

P.O. Box 6780, Harrisburg, PA 17112 USA
T:877-671-2955 F:717-810-2862
www.applicationtooling.com

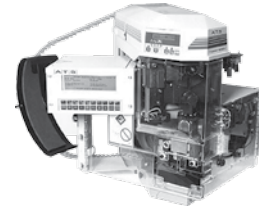

| Crimping Technical Reference |

Crimping, Soldering, and Assembly Best Practices. Instructions for proper assembly are available for each connector and should be followed. These best practices are for reference only.

Stripping Wire Insulation

Problems with cable harness and connector systems often begin with improper or accidental cutting of wire strands when stripping wire insulation. Each strand is important, and all of them must be included in the contact barrel to avoid unnecessary hot spots during later operation. When removing insulation, position a sharp blade at a right angle and apply a steady controlled pressure cutting only the cable insulation and not the copper wire strands. Wires should be stripped to the lengths specified in the specific connector assembly instruction.

Cleaning Copper Wire

Copper oxide, a non-conductive material accumulates on copper wires exposed to oxygen and moisture. Aged and badly tarnished copper wire needs to be thoroughly cleaned to realize the rated performance of the connector and wire. Heavy oxidation can be scraped off with a stiff wire brush that penetrates the entire bundle and cleans every strand. For light surface oxidation a 3M Scotch Bright™ pad is recommended. The wires are ready for insertion into the contact barrel when they are burnished to their original bright copper finish. Contact barrels are lined with silver or tin plating to assure consistently high conductivity which will be reduced if the barrel is crimped around aged or tarnished wire.

Crimping

APP® connectors are designed to achieve the highest levels of durability, reliability, and performance as shown on the connector data sheets. Crimp tooling is a critical link between the designed performance of an APP® connector and the realization of that performance by our customers.

As part of the connector design and testing process, APP® recommends a limited number of crimp solutions that have proven to deliver the intended connector performance in a process that is repeatable. Only these solutions tested by APP® are listed in the conditions of acceptability from safety agencies such as UL, CSA, and TUV.

Use of tooling solutions not tested by APP® can affect not only performance but also safety agency approvals. Problems attributable to use of tools not recommended by APP® include:

Electrical and Thermal

- High electrical resistance
- Failure to realize designed current and voltage carrying capability
- Overheating
- Melting of connector housings

Mechanical

- Contacts not able to fit inside connector housings.
- Contacts not seated properly in connector housings causing: shorts, intermittent circuits, abnormally high or low mating and unmating force, & low retention force of the contact in the housing

Soldering

The alternative to crimping is to solder all cable strands within the contact barrel. When using an open flame, make sure that you are not in an area where explosive gasses are present. The right proportion of solder is essential if this procedure is employed. Use a quality 60/40 solder (60 percent tin, 40 percent lead) in wire form with a rosin flux core. Cable strands should be separately fluxed with rosin paste, and the contact should be held in a vise with the barrel end facing up. Apply heat to the outside of the barrel while the solder flows in beside the wire strands.

Here are some things to avoid when soldering:

- A. Don't use too much solder, to the point that it flows out of the contact barrel.
- B. Don't allow flux or solder on the outside of the contact. This will interfere with contact mounting within the installation or with the contact connection to a mating connector.
- C. Don't overheat and cause excessive solder to "wick" up into the cable and stiffen it. This could interfere with contact flexibility when connectors are mated.
- D. Don't solder when contact is in the connector housing. Solder away from the housing and then insert the contact into the housing after it has cooled.

NOTE: Underwriters Laboratories (UL) requires the use of a cable clamp for soldered connections to unsupported wires.

| Determining If A Good Crimp Has Been Made |

1. Assure the correct wire size and type is used for the specific contact being crimped.
2. Follow the assembly instructions for the connector. Special attention should be paid to wire preparation and stripping.
3. Use the correct application tooling as recommended by Anderson Power Products® (tool, die, & locator).
4. Make several crimps "for testing, and record crimp dimensions in both "x" and "y" planes.
5. Test the electrical resistance across a mated pair of connectors to the standard of the information provided on the data sheet.
 - a. The electrical resistance values should be similar to (or less than) what we publish for that connector in our catalogs. Please see the "Avg. Mated Contact Resistance" on the data sheet for the specific connector.
6. Test the pull out strength per the table to the right.
 - a. To achieve the electrical performance published in our literature the pull out values at minimum should meet the UL 486A values for the wire size being used. The first column (lower value) pull out is the minimum per UL486A. The second column is what APP tries to achieve when designing our crimp solutions. Any force within this range is acceptable.
7. If crimps are within electrical and mechanical specifications then the crimp dimensions are suitable to be used as a secondary inspection criteria.

Wire Size AWG or MCM	Lbf Contact Retention Force Range	kgf Contact Retention Force Range
22	8 - 12	3.6 - 5.4
20	13 - 16	5.9 - 7.3
18	20 - 30	9.1 - 13.6
16	30 - 40	13.6 - 18.1
14	50 - 60	22.7 - 27.2
12	70 - 85	31.8 - 38.6
10	80 - 125	36.3 - 56.7
8	90 - 180	40.8 - 81.6
6	100 - 200	45.4 - 90.7
4	140 - 280	63.5 - 127
3	160 - 320	72.3 - 145.1
2	180 - 360	81.6 - 163.3
1	200 - 400	90.7 - 181.4
1/0	250 - 500	113.4 - 226.8
2/0	300 - 600	136.1 - 272.2
3/0	350 - 700	158.8 - 317.5
4/0	450 - 775	204.1 - 351.5
250	500 - 800	226.8 - 362.9
300	550 - 800	249.5 - 362.9

| Why Crimp Dimensions Are Not Suitable as Primary Inspection Criteria |

Crimp dimensions are not an adequate or reliable means to evaluate if a good crimp has been made. For this reason they should not be relied upon as a primary inspection method.

When you crimp a contact, the material is forced down to the size of the fully closed die. This die closure on most tools is a fixed dimension. When the die is released, the material (contact and wire) will expand back out when they are no longer restrained by the die. The amount that it expands outwards or “bounces back” is dependant on the resistance or force that the material in the contact and wire places against the crimp die. The resistance of the material to being formed by the crimp will vary with wire type and stranding, hardness of the metal (both contact and wire), as well as the temperature. It is for this reason that the crimp height is a variable and cannot be relied upon solely to determine if a crimp is good or not.

| Crimp Dimensions as Secondary Inspection Criteria |

Crimp dimensions should only be used as secondary inspection criteria due to the above variables. These variables make it impossible for Anderson Power Products to determine what the correct crimp dimension should be without evaluation of the specific instance. Accordingly harness manufacturers are responsible for determining the appropriate crimp dimensions to be used and only as a secondary inspection method. Crimp dimensions are an acceptable means of short interval inspection for determining homogeneity within a batch provided:

1. Electrical resistance and pull out strength are tested on samples from the batch to ensure the crimp dimensions are indicative of a good crimp.
2. The same tooling is used throughout the batch and operated in the same manner, at the same calibration level.
3. The same wire is used throughout the batch. (Wire can vary significantly by factors ranging from class to manufacturer).
4. Assembly instructions are closely followed, especially wire stripping and preparation.

| Other Critical Crimp Dimensions |

There are other critical crimp dimensions that impact if a crimp is good or not. All APP® contacts are designed to work with a specific crimping solution to minimize the distortion of crimping force on the critical geometries of the contact. If the incorrect crimp solution is used or the correct crimp solution is improperly used, then this will distort the intended geometries of the contact.

The geometry of the contact blade and its relative angle to the crimp barrel must be maintained after the contact is crimped. If these dimensions are not maintained the contact will not latch properly in the housing. This can impact how well the contact is secured in the housing as well as the normal force (measurement of the opposing force that pushes the contacts together) between the mating blades of two mating contacts. The normal force is directly related to the electrical properties of the connector and poor normal force can lead to higher electrical resistance, overheating, and reduced current capability. These geometries can only be assured by using the correct crimp tool, with proper die and locator.

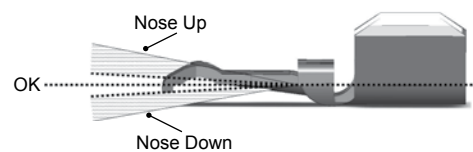

Part Number Page Reference

P/N	Page #	P/N	Page #	P/N	Page #	P/N	Page #
902	67	6355	88, 94	114555P8	29	1321G8	36
906	71	6356	88, 94	114555P9	29	1321G8-BK	36
907	72, 75	6358	88, 94	11536G2	74	1323G1	36, 43, 63, 75
908	72, 75	6361	88	115G1	24	1323G1-BK	36, 63
910	72, 75	6362	88	115G1-BK	24	1323G2	36, 43
911	73	6394	88	115G2	24	1323G2-BK	36
912	71	104G17	54, 60	115G2-BK	24	1327-BK	20
913	71	105G1	70, 87	115G3	24	1327FP	20
914	71	105G13	79	115G3-BK	24	1327FP-BK	20
916	72, 75	105G3	69	115G4	24	1327G16	20
917	72, 75	105G8	69, 84	115G4-BK	24	1327G16-BK	20
919	74	106G6	74, 93	115G7	24	1327G16FP	20
923	70	106G7	73, 90	115G7-BK	24	1327G16FP-BK	20
924	70	106G8	74	115G8	24	1327G17	20
931	71	110G10	24	115G8-BK	24	1327G17-BK	20
932	71	110G12	29	120BBS	63	1327G18	20
940	66	110G16	28	1303G12	43, 75, 94	1327G18-BK	20
941	66	110G17	28	1303G13	43, 75	1327G21	20
942	66	110G18	35, 42	1303G17	94	1327G21-BK	20
943	66	110G19	35, 38	1303G2	94	1327G22	20
945	69	110G20	38, 42	1303G3	75	1327G22-BK	20
949	66	110G21	29	1303G8	94	1327G23	20
990	55, 61	110G34	67	1304G2	94	1327G23-BK	20
992	57	110G50	25	1304G28	94	1327G5	20
1307	31, 43, 58, 75	110G51	25	1304G31	75	1327G5-BK	20
1309	95	110G54	31, 58, 63	1304G32	43, 75	1327G5FP	20
1319	36, 43, 63, 75	110G55	40, 67	1304G34	94	1327G5FP-BK	20
1321	36	110G56	40, 67	1304G35	94	1327G6	20, 79, 85, 91
1327	20, 79, 85, 91	110G59-BK	92	1304G36	94	1327G6-BK	20
1331	21, 43, 79, 85, 91, 94	110G68	29	1307-BK	31, 58	1327G6FP	20
1332	21, 43, 91, 94	110G73	72	1309G2	43, 94	1327G6FP-BK	20
1347	39, 43, 67, 75	110G9	24, 79, 81	1309G3	43	1327G7	20
1348	39, 43, 67, 75	110G9-BK	24, 81, 87	1309G4	43, 56, 75, 94	1327G7-BK	20
1368	43, 75, 94, 95	111812P5	28	1309G6	43	1327G7FP	20
1381	39	111812P6	35, 42	1309G8	43, 94	1327G7FP-BK	20
1382	39, 43, 67, 75	111812P7	35, 38	1317G1	21	1327G8	20
1383	39, 43, 67, 75	111812P8	38, 42	1317G11	21	1327G8-BK	20
1384	39, 43, 67, 75	111822G1	79, 85	1317G11-BK	21	1327G8FP	20
5648	42, 70, 87, 93	111961P1	93	1317G12	21	1327G8FP-BK	20
5663	42, 70, 87, 93	111961P2	87	1317G12-BK	21	1328G1	39, 43
5687	42, 70, 87, 93	113715P4	79	1317G13	21	1328G1-BK	39
5690	42, 70, 87, 93	113716P3	79	1317G13-BK	21	1328G2	39, 43
5693	42, 70, 87, 93	113890P1	55, 60	1317G1-BK	21	1328G2-BK	39
5900	31, 43, 58, 75	113890P2	69	1317G2	21	1331-BK	21
5905	55, 61	113890P3	73	1317G2-BK	21	1332-BK	21
5910	35, 56, 61, 81	113899P1	54, 60, 65	1317G3	21	1335G1	21
5912	35, 56, 61, 81	113952P1	79	1317G3-BK	21	1336G1	21
5913	35, 56, 61, 81	113953P1	79	1317G4	21	1337G1	21
5915	31, 43, 58, 75	114360G1	91	1317G4-BK	21	1339G1	77, 94
5916	30	114411P1	34	1319-BK	36, 63	1339G1-BK	77
5918	74, 93	114411P2	34	1319G4	36, 43, 63, 75	1339G2	51, 56
5919	38, 65	114411P3	34	1319G4-BK	36, 63	1339G2-BK	51
5920	38, 65, 87, 93	114555P1	29	1319G6	36, 43, 63, 75	1339G3	51, 56
5921	38, 65	114555P10	29	1319G6-BK	36, 63	1339G3-BK	51
5952	31, 43, 58, 75	114555P11	29	1321-BK	36	1339G4	77, 94
5953	31, 43, 58, 75	114555P12	29	1321G1	36	1339G4-BK	77
6339	88	114555P13	29	1321G1-BK	36	1339G5	51, 56
6344	79, 85	114555P14	29	1321G2	36	1339G5-BK	51
6350	88	114555P2	29	1321G2-BK	36	1340G1	51, 56
6351	88	114555P3	29	1321G3	36	1340G1-BK	51
6352	88	114555P4	29	1321G3-BK	36	1340G2	51, 56
6353	88	114555P6	29	1321G4	36	1340G2-BK	51
6354	88, 94	114555P7	29	1321G4-BK	36	1340G3	51, 56

P/N	Page #	P/N	Page #	P/N	Page #	P/N	Page #
1340G3-BK	51	1399G14-BK	28	200G1L	20, 43	2-8171G5	88
1341G1	89, 94	1399G17	28	200G1L-LPBK	20, 43	2-8171G6	88
1341G1-BK	89	1399G17-BK	28	200G2L	20, 43	2-8171G7	88
1341G2	89, 94	1399G1-BK	28	200G2L-LPBK	20, 43	2-8171G8	88
1341G2-BK	89	1399G2	28	200G3L	21, 43	2-8171G9	88
1341G3	89, 94	1399G20	34	200G3L-LPBK	21, 43	2-8675P1	92
1341G3-BK	89	1399G20-BK	34	200G4L	21, 43	2-8675P2	86
1347-BK	39, 67	1399G2-BK	28	200G4L-LPBK	43	3-5074P1	69, 73, 84, 90
1348-BK	39, 67	1399G6	28	201G1H	21, 43	3-5074P3	69, 73, 84, 90
134G1	55, 60	1399G6-BK	28	201G1H-LPBK	21, 43	3-5074P5	69, 73, 84, 90
134G2	69	1399G7	34	201G3H	21, 43	350BBS	72
134G3	73	1399G7-BK	34	201G3H-LPBK	43	3-54500-1	43, 75
134G4	65	1399G8	28	2-5048	67	354578-1	43, 75
1367G1	43, 94	1399G8-BK	28	2-5049	67	3-5798P1	81, 86, 92
1377G1	21	1399G9	28	2-565435-2	43, 75	3-5911P1	21
1377G11	21	1399G9-BK	28	26-01	25	3-5912P1	21
1377G11-BK	21	1424266-1	43, 75	261G1	20, 43	3-5913P1	21
1377G12	21	1441G1	29	261G1-LPBK	20, 43	3-5952P1	22
1377G12-BK	21	1442G1	29	261G2	20, 43	3-5956P1	80, 85, 91
1377G13	21	1460G1	23	261G2-LPBK	20, 43	440G1	91
1377G13-BK	21	1460G1-BK	23	261G3	21, 43	440G2	91
1377G1-BK	21	1460G2	23	261G3-LPBK	21, 43	440G3	91
1377G2	21	1460G2-BK	23	261G4	21, 43	441G1	80, 85
1377G2-BK	21	1460G3	23	261G4-LPBK	21, 43	441G2	80, 85
1377G3	21	1460G3-BK	23	262G1	20, 43	441G3	80, 85
1377G3-BK	21	1460G4	23	262G1-LPBK	20, 43	444G1	80, 85, 91
1377G4	21	1460G4-BK	23	262G2	21, 43	4802G3	81, 86, 92, 94
1377G4-BK	21	1461G1	23	262G2-LPBK	21, 43	4802G3-BK	81, 86, 92
1381-BK	39	1461G1-BK	23	265G5	31, 43, 58, 75	4803G3	81, 86, 92, 94
1381G1	39	1461G2	23	265G6	31, 43, 58, 75	4803G3-BK	81, 86, 92
1381G1-BK	39	1461G2-BK	23	269G1	20, 43	4827G6	80, 86, 92
1381G2	39	1461G3	23	269G1-LPBK	20, 43	4827G6-BK	80, 86, 92
1381G2-BK	39	1461G3-BK	23	269G2	20, 43	4850G6	80, 86, 92
1381G3	39	1462G1	28	269G2-LPBK	20, 43	5648-BK	42, 70, 87, 93
1381G3-BK	39	1462G2	28	269G3	20, 43	5663-BK	42, 70, 87, 93
1381G4	39	1462G3	28	269G3-LPBK	20, 43	5687-BK	42, 70, 87, 93
1381G4-BK	39	1463G1	35	27-01	25	5690-BK	42, 70, 87, 93
1382-BK	39, 67	1463G2	35	2-7249G1	88	5693-BK	42, 70, 87, 93
1383-BK	39, 67	1464G1	38	2-7249G2	88	5900-BK	31, 58
1384-BK	39, 67	1464G2	38	2-7249G3	88	5905-BK	55, 61
1385458-1	43	1465G1	42	2-7249G4	88	5910-BK	35, 56, 61, 81
1385460-1	43	1465G2	42	2-7249G5	88	5912-BK	35, 56, 61, 81
1385519-1	43	1466G1	54	2-7249G6	88	5913-BK	35, 56, 61, 81
1385520-1	43	1467G1	65	2-7249G7	88	5915-BK	31, 58
1385522-1	43, 75	1470G1	24	2-7250G8	71	5916-BK	30
1385523-1	43, 75	1470G1-BK	24	2-7251G1	82	5916G14	30
1387G1	43, 56, 75, 94, 95	1470G2	24	2-7251G2	82	5916G14-BK	30
1387G2	43, 75, 94, 95	1470G2-BK	24	2-7251G3	82	5916G15	30
1388G3	43, 75, 94	1470G3	24	2-7251G4	82	5916G15-BK	30
1388G4	43, 75	1470G3-BK	24	2-7251G5	82	5916G16	30
1388G6	43, 56, 75, 94	1470G4	24	2-7251G7	82	5916G16-BK	30
1388G7	43, 56, 75, 94	1470G4-BK	24	2-7252G11	66	5916G4	30
1389G20	56	1725900-2	43, 75	2-8170G1	82	5916G4-BK	30
1389G3	43, 75, 94	180BBS	40, 67	2-8170G14	82	5916G5	30
1389G4	43, 75	180BBS-BK	40, 67	2-8170G2	82	5916G5-BK	30
1389G6	43, 75	1827G1	20	2-8170G3	82	5916G6	30
1389G9	56, 94	1827G1-BK	20	2-8170G4	82	5916G6-BK	30
1399G1	28	1830G1	21, 43	2-8170G5	82	5916G7	30
1399G10	28	1830G1-LPBK	21, 43	2-8170G7	82	5916G7-BK	30
1399G10-BK	28	1830G2	21, 43	2-8171G1	88	5918-BK	74, 93
1399G13	28	1830G2-LPBK	21, 43	2-8171G2	88	5919-BK	38, 65
1399G13-BK	28	1836G1	22	2-8171G3	88	5920-BK	38, 65, 87, 93
1399G14	28	20-01	25	2-8171G4	88	5921-BK	38, 65

P/N	Page #	P/N	Page #	P/N	Page #	P/N	Page #
5952-BK	31, 58	931-BK	71	ASMFV45-2X1-KR	22	P992-BK	57
5953-BK	31, 58	932-BK	71	ASMFV45-2X1-RK	22	P992G1	57
6305G1	91	940-BK	66	ASMFV45-2X2-WEKR	22	P992G1-BK	57
6310G1	91	941-BK	66	ASMPP30-1X2-KR	22	P992G2	57
6354-BK	88	942-BK	66	ASMPP30-1X2-RK	22	P992G2-BK	57
6355-BK	88	943-BK	66	ASMPR45-1X2-KR	22	PC5930S	31, 58
6356-BK	88	945G2	84	ASMPR45-1X2-RK	22	PC5930S-BK	31, 58
6358-BK	88	945G3	69	ASMPV45-1X2-KR	22	PC5930T	31, 58
6380G1	82	945G3-BK	69	ASMPV45-1X2-RK	22	PC5930T-BK	31, 58
6381G1	82	946G1	69	B00229P1	74	PC5933S	32, 59
6382G1	82	946G1-BK	69	B00333P1	70	PC5933S-BK	32, 59
6383G1	82	949-BK	66	B00511G2	87	PC5933T	32, 59
6384G1	82, 94	981G1	65	B00511G4	93	PC5933T-BK	32, 59
6384G1-BK	82	981G2	65	B01956P4	31, 58	PC5934S	32, 58
6384G2	82, 94	990-BK	55, 61	B01997P1	63	PC5934S-BK	32, 58
6384G2-BK	82	990G1	55, 61	B01998P1	72	PC5934T	32, 58
6385G1	82	990G1-BK	55, 61	B02019P1	65	PC5934T-BK	32, 58
6390G1	82	990G2	55, 61	BMHSG-P	25	PC-HSG-PP	35
6394-BK	88	990G2-BK	55, 61	BMHSG-R	25	PC-HSG-PP-BK	35
6396G1	81, 86, 92	992-BK	57	BMPP10-45P	25	PC-HSG-SB	61
6810G1	62	992G1	57	BMPP10-45R	25	PC-HSG-SB-BK	61
6810G1-BK	62	992G1-BK	57	E6336	88	PCSTAPLE-1	35
6810G2	62	992G2	57	E6339	88	PCSTAPLE-2	35
6810G2-BK	62	992G2-BK	57	E6349	88	PM1000G1	56, 94, 95
6810G3	62	992G4	57	E6351	88	PM16P12A30	51, 80, 85, 91
6810G3-BK	62	992G4-BK	57	E6352	88	PM16P12A30-50	51, 80, 85, 91
6811G4	36, 63	992G5	57	E6353	88	PM16P12B30	51, 80, 85, 91
6811G4-BK	36	992G5-BK	57	E6361	88	PM16P12B30-50	51, 80, 85, 91
6811G4-BK	63	992G6	57	E6362	88	PM16P12C30	51, 80, 85, 91
6811G5	36, 63	992G6-BK	57	E6380G1	82, 88	PM16P12C30-50	51, 80, 85, 91
6811G5-BK	36, 63	992G7	57	E6381G1	82	PM16P12S30	51, 80, 85, 91
6811G6	36, 63	992G7-BK	57	E6382G1	82	PM16P12S30-50	51, 80, 85, 91
6811G6-BK	36, 63	993G1	93	E6383G1	82	PM16P1416A30	51, 80, 85, 91
692655-1	43, 75	993G2	87	E6385G1	82	PM16P1416A30-50	51, 80, 85, 91
75BBS	31, 58	994G1	93	E6390G1	82	PM16P1416B30	51, 80, 85, 91
75LOKBLK	31	994G2	87	E6392G1	82	PM16P1416B30-50	51, 80, 85, 91
75LOKBLK-BK	31	995G1	69, 84	GA-175	69	PM16P1416C30	51, 80, 85, 91
75LOKBLU	31	995G1-APP	69, 84	GA-350	74	PM16P1416C30-50	51, 80, 85, 91
75LOKBLU-BK	31	995G2	73, 90	H1120P41	54, 60	PM16P1416S30	51, 80, 85, 91
75LOKGRA	31	995G2-APP	73, 90	H1120P42	79	PM16P1416S30-50	51, 80, 85, 91
75LOKGRA-BK	31	995G3	69, 84	H1120P43	65	PM16P1620A30	51, 80, 85, 91
75LOKGRN	31	995G3-APP	69, 84	H1216P7	40, 67	PM16P1620A30-50	51, 80, 85, 91
75LOKGRN-BK	31	995G4	73, 90	H1216P8	31, 58, 63	PM16P1620B30	51, 80, 85, 91
75LOKRED	31	995G4-APP	73, 90	H1216P9	72	PM16P1620B30-50	51, 80, 85, 91
75LOKRED-BK	31	996G1	73	H1507P38	28	PM16P1620C30	51, 80, 85, 91
75LOKSMTBLU	34	ASMFP30-1X2-KR	22	H1835P3	81, 87, 93	PM16P1620C30-50	51, 80, 85, 91
75LOKSMTBLU-BK	34	ASMFP30-1X2-RK	22	P5916-BK	30	PM16P1620S30	51, 80, 85, 91
75LOKWHT	31	ASMFP30-1X3-KER	22	P5916G4-BK	30	PM16P1620S30-50	51, 80, 85, 91
75LOKWHT-BK	31	ASMFP30-1X3-KEW	22	P5916G5-BK	30	PM16P2024A30	51, 80, 85, 91
75LOKWNGBLU-BK	34	ASMFP30-2X1-KR	22	P5916G7-BK	30	PM16P2024A30-50	51, 80, 85, 91
75LOKWNGBLU-R-BK	34	ASMFP30-2X1-RK	22	P6810G1	62	PM16P2024B30	51, 80, 85, 91
906-BK	71	ASMFP30-2X2-KRWE	22	P6810G1-BK	62	PM16P2024B30-50	51, 80, 85, 91
907-BK	72	ASMFP30-2X2-WEKR	22	P6810G3	62	PM16P2024C30	51, 80, 85, 91
908-BK	72	ASMPR45-1X2-KR	22	P6810G3-BK	62	PM16P2024C30-50	51, 80, 85, 91
910-BK	72	ASMPR45-1X2-RK	22	P906	71	PM16P2024S30	51, 80, 85, 91
911G2	90	ASMPR45-1X3-KER	22	P906-BK	71	PM16P2024S30-50	51, 80, 85, 91
912-BK	71	ASMPR45-1X3-KEW	22	P913	71	PM16S12S32	51, 80, 85, 91
913-BK	71	ASMPR45-2X1-KR	22	P913-BK	71	PM16S12S32-50	51, 80, 85, 91
914-BK	71	ASMPR45-2X1-RK	22	P940	66	PM16S1416S32	51, 80, 86, 91
916-BK	72	ASMPR45-2X2-WEKR	22	P940-BK	66	PM16S1416S32-50	51, 80, 86, 91
917-BK	72	ASMFV45-1X2-KR	22	P949	66	PM16S1620S32	51, 80, 86, 91
919G1	74	ASMFV45-1X2-RK	22	P949-BK	66	PM16S1620S32-50	51, 80, 86, 91
922G1	74	ASMFV45-1X3-KEW	22	P992	57	PM16S2024S32	51, 80, 86, 91

P/N	Page #	P/N	Page #	P/N	Page #	P/N	Page #
PM16S2024S32-50	51, 80, 86, 91	SBS75GGRA-BK	50				
PSBS50BLK	49	SBS75GHDL-RED	55				
PSBS50BLK-BK	49	SBS75GPRBLK	50				
PSBS50BLU	49	SBS75GPRBLK-BK	50				
PSBS50BLU-BK	49	SBS75XBLK	50				
PSBS50BRN	49	SBS75XBLK-BK	50				
PSBS50BRN-BK	49	SBS75XBRN	50				
PSBS50GRA	49	SBS75XBRN-BK	50				
PSBS50GRA-BK	49	SBS75XCLP1-BK	55				
PSBS50GRN	49	SBS75XCLP2-BK	55				
PSBS50GRN-BK	49	SBS75XPRBLK	50				
PSBS50RED	49	SBS75XPRBLK-BK	50				
PSBS50RED-BK	49	TL0001	56,94				
PSBS75XBLK	50	TL0002	56,94				
PSBS75XBLK-BK	50	TL0005	94				
PSBS75XGRN	50	TM0001	56, 94, 95				
PSBS75XGRN-BK	50	TP0001	56, 94, 95				
SB120-HDL-RED	65						
SB175-LOCKOUT	69						
SB350-LOCKOUT	74						
SB50-HDL-RED	60						
SBE80CLPRED	79						
SBE80GRA	77						
SBE80GRA-BK	77						
SBE80HDLRED	79						
SBE80ORN	77						
SBE80ORN-BK	77						
SBE80RED	77						
SBE80RED-BK	77						
SBE80YEL	77						
SBE80YEL-BK	77						
SBO60CLPRED	79						
SBO60HDLRED	79						
SBO60ORN	77						
SBO60ORN-BK	77						
SBO60RED	77						
SBO60RED-BK	77						
SBO60WHT	77						
SBO60WHT-BK	77						
SBO60YEL	77						
SBO60YEL-BK	77						
SBS50BLK	49						
SBS50BLK-BK	49						
SBS50BLU	49						
SBS50BLU-BK	49						
SBS50BRN	49						
SBS50BRN-BK	49						
SBS50GRA	49						
SBS50GRA-BK	49						
SBS50GRN	49						
SBS50GRN-BK	49						
SBS50-HDL-RED	54						
SBS50RED	49						
SBS50RED-BK	49						
SBS50WHT	49						
SBS50WHT-BK	49						
SBS75GBLK	50						
SBS75GBLK-BK	50						
SBS75GBLU	50						
SBS75GBLU-BK	50						
SBS75GBRN	50						
SBS75GBRN-BK	50						
SBS75GGRA	50						

This page is blank.

Environmentally Sealed SPEC Pak® Connectors

Featuring Powerpole® Connector Technology



- Environmentally Sealed, IP68, Shells
- UV and Chemical Resistant Ruggedized Shells
- 15 to 310 Amps per Contact
- Utilizes Powerpole® 15 - 180 Connectors
- Latching and Locking Features
- Customer Configurable

Additional APP® Products

Saf-D-Grid®



- Touch Safe Plug and Receptacle
- Integral Latch
- IEC320 C14 Drop In Replacement

PowerMod®HP



- Touch Safe Female Side
- Hot Pluggable, Low Resistance
- Latching, Panel Mount and Busbar

EBC / DIN



- "E" Series For Euro Norm Compliance and Metric Cables
- "A" Series For UL and CSA Approvals With AWG Cables

HEADQUARTERS

Anderson Power Products®
13 Pratts Junction Road
Sterling, MA 01564-2305 USA
T: 978-422-3600
F: 978-422-0128

EUROPE

Anderson Power Products® Ltd.
Unit 3 Europa Court
Europa Boulevard
Westbrook, Warrington
Cheshire, WA5 7TN United Kingdom
T: +44 (0) 1925 428390
F: +44 (0) 1925 520203

ASIA / PACIFIC

IDEAL Anderson Asia Pacific Ltd.
Unit 922-928, Topsail Plaza
11 On Sum Street
Shatin N.T., Hong Kong
T: +(852) 2636 0836
F: +(852) 2635 9036

CHINA

IDEAL Anderson Technologies (Shenzhen) Ltd.
Block A8, Tantou Western Industrial Park
Songgang, Baoan District
Shenzhen, P.R. China 518105
T: +(86) 755 2768 2118/3393 2388
F: +(86) 755 2768 2218

TAIWAN

IDEAL Anderson Asia Pacific Ltd.
Taiwan Branch, 4F.-2, No.116
Dadun 20th St., Situn District
Taichung City 407, Taiwan (R.O.C.)
T: +(886) 4 2310 6451
F: +(886) 4 2310 6460



VISIT US AT WWW.ANDERSONPOWER.COM

15221 CAT-PPMP REV 03

APP
Anderson Power Products®