

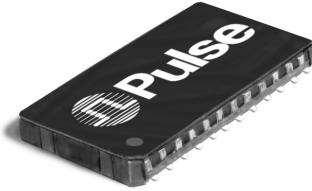





1000BASE-T MAGNETICS MODULE

Designed to Support Gigabit Transceivers



-  Designed for Long-haul Gigabit Ethernet (10/100/1000Base-T) applications
-  Cable interface for isolation and low common mode emissions
-  Smallest footprint to minimize board space
-  Compliant with IEEE 802.3ab standard
-  Compliant with RoHS Directive with peak solder rating of 245°C

Electrical Specifications @ 25°C — Operating Temperature 0°C to 70°C

Part Number	Insertion Loss (dB MAX)	Return Loss (dB MIN @ 100Ω)					Differential to Common Mode Rejection (dB MIN)			Crosstalk (dB MIN)			Hipot (Vrms MIN)
		1-100 MHz	1-30 MHz	40-50 MHz	60-80 MHz	100 MHz	30 MHz	60 MHz	100 MHz	30 MHz	60 MHz	100 MHz	
H5120NL ¹	1.0	-18	-16	-12	-10	-43	-37	-33	-45	-40	35	1500	

1. Add "T" to the end of the part number for Tape & Reel option. For example, H5120NL becomes H5120NLT.

Mechanical

H5120NL

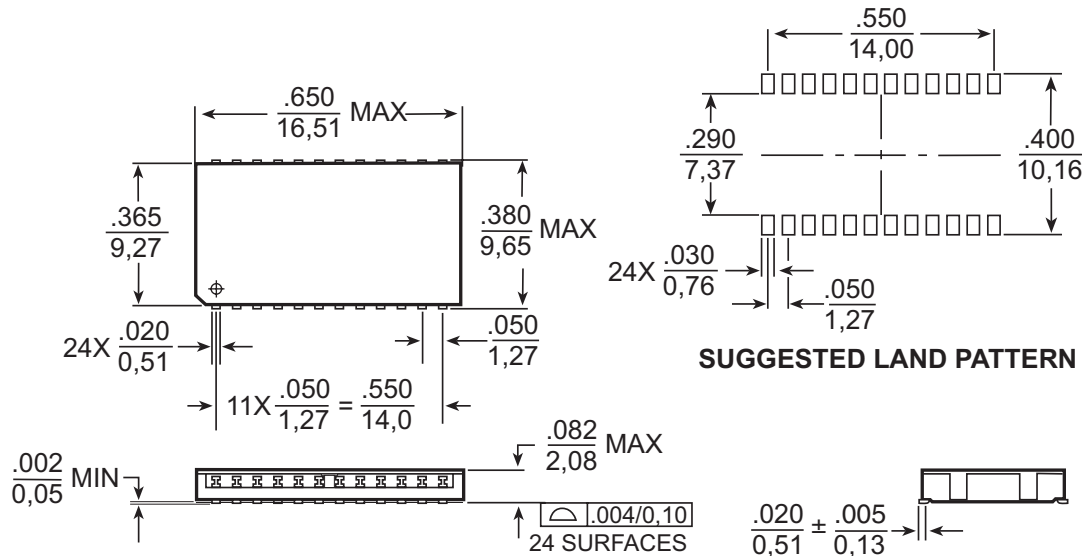

Weight 0.54 grams
Tape & Reel 1000
Tube 30

Dimensions: $\frac{\text{Inches}}{\text{mm}}$ Unless otherwise specified, all tolerances are $\pm \frac{.010}{.025}$

1000BASE-T MAGNETICS MODULE

Designed to Support Gigabit Transceivers



Schematic

H5120NL

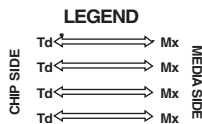
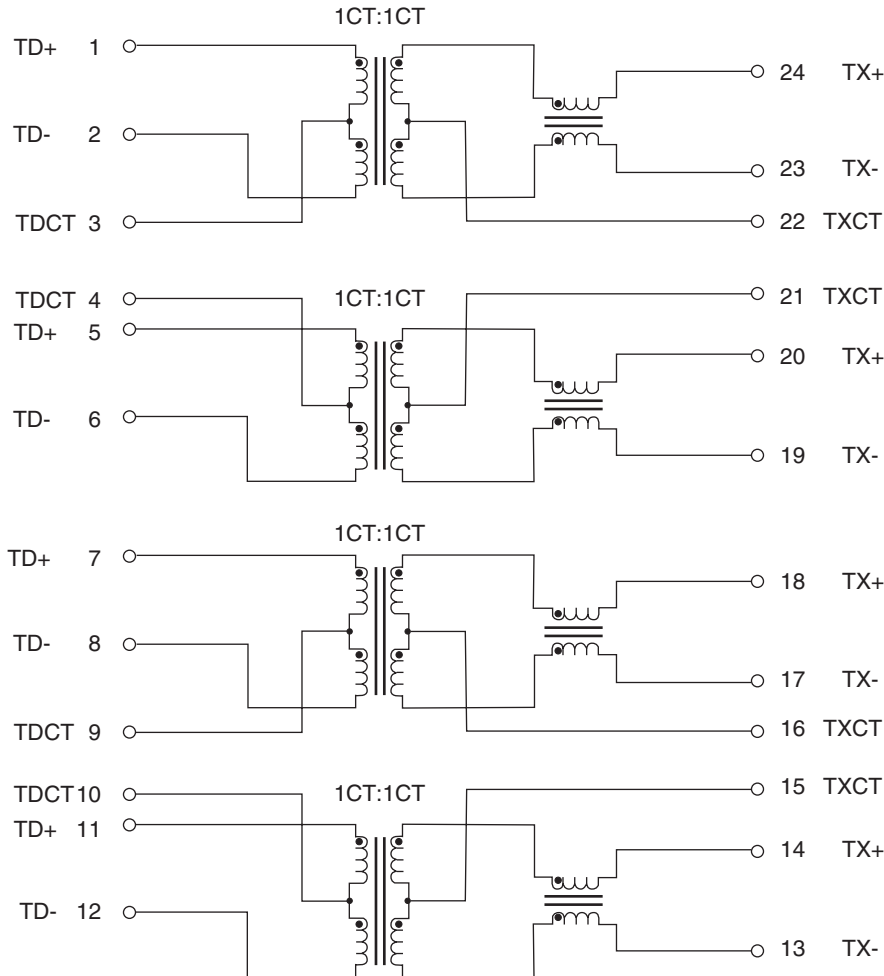

For More Information:

Pulse Worldwide Headquarters
12220 World Trade Drive
San Diego, CA 92128
U.S.A.
www.pulseeng.com
TEL: 858 674 8100
FAX: 858 674 8262

Pulse Northern Europe
3 Huxley Road
Surrey Research Park
Guildford, Surrey GU2 5RE
United Kingdom
TEL: 44 1483 401700
FAX: 44 1483 401701

Pulse Southern Europe
Zone Industrielle
F-39270
Orgelet
France
TEL: 33 3 84 35 04 04
FAX: 33 3 84 25 46 41

Pulse China Headquarters
No. 1
Industrial District
Changan, Dongguan
China
TEL: 86 769 85538070
FAX: 86 769 85538070

Pulse North China
Room 1503
XinYin Building
No. 888 YiShan Road
Shanghai 200233
China
TEL: 86 21 54643211/2
FAX: 86 21 54643210

Pulse South Asia
135 Joo Seng Rd.
#03-02
PM Industrial Bldg.
Singapore 368363
TEL: 65 6287 8998
FAX: 65 6280 0080

Pulse North Asia
No. 26
Kao Ching Road
Yang Mei Chen
Taoyuan Hsien
Taiwan, R. O. C.
TEL: 886 3 4641811
FAX: 886 3 4641911

This is a "Preliminary" product data sheet. Products mentioned on this data sheet are in development and in the process of being qualified. These products are not fully released nor are they in production. Features, specifications and performance of products offered are subject to change without notice. Other brand and product names mentioned herein may be products and/or registered trademarks of their respective owners. For current information on this product, please contact the Pulse office nearest you and ask for the "LAN Applications Engineer."

© Copyright, 2006. Pulse Engineering, Inc. All rights reserved.

www.pulseeng.com

H550.Q (1/09)