



SPECIFICATION

- Part No. : **MA603.A.ABK.001**
- Product Name : Spartan Antenna 3in1 MA603
Low Profile Screw-Mount (Permanent Mount)
GPS/GLONASS/Cellular/915MHz combination antenna
- Features : Cellular
- 850/900/1700/1800/2100MHz
 - GSM/CDMA/UMTS/HSPA
- GPS/GLONASS -1575~1602MHz 5dBiC
915MHz (902MHz~928 MHz) 3dBi (incl. 3m cable)
IP67 Waterproof
High Efficiency / Peak Gain Outdoor Antenna
Advanced RF Design and Materials
Heavy Duty – Integrated Metal Base/ Ground-plane
Standard 3 meters low loss cables
Custom cables and connectors available
- RoHS Compliant



1. Introduction

The Spartan MA603 antenna is a low profile, heavy-duty, fully IP67 waterproof external M2M antenna for use in telematics, transportation and remote monitoring applications.

The Spartan MA603 antenna is unique in the market because it combines 3in1 GPS/GLONASS, Cellular (2G and 3G) and 915MHz antennas in a heavy-duty structure with high efficiency in a low profile compact format at 35mm(1.38”) profile Height. The antenna screws down permanently onto a roof or metal panel and can be pole or wall-mounted.

For industries such as commercial vehicle telematics, remote monitoring, smart meter systems, construction equipment, at only 35mm high, the Spartan provides an unobtrusive, robust, rugged antenna that is durable even in extreme environments.

Custom designed integrated wall mounted and pole mounted brackets are available for the Spartan antennas. These patent pending mounts allow for 180 degrees freedom of movement of the antennas for ease of positioning while also preventing access to the cables so they cannot be cut by vandals or thieves and also protecting the cables from long term weather exposure. The removal of unsightly cables also leads to a cleaner more professional installation and look, and makes the antenna less identifiable and more unobtrusive. Customized cable sleeves can be supplied for extra protection where required.

2. Specification

GPS-GLONASS						
Centre Frequency	1575.42MHz / 1602MHz					
Bandwidth	10MHz					
Radiation Efficiency	50(without cable)					
Passive Gain @ Zenith	4.0 typ(with $\psi=140\text{mm}$ ground)					
VSWR	2					
Impedance	50 Ω					
DC Power Input Range	3 ~ 5V					
DC input	3.3V		4.0V		5.5V	
MHz	1575.42	1602	1575.42	1602	1575.42	1602
VSWR	2	2	2	2	2	2
LNA Gain	29.2	29	31	31	32.3	32
Noise Figure	3.1	3.1	3.2	3.2	3.4	3.4
Power Consumption	7.5	7.5	9.4	9.4	15	15
Band Attenuation	1520MHz: -20dB 1642MHz: -20dB		1520MHz: -20dB 1642MHz: -20dB		1520MHz: -20dB 1642MHz: -20dB	
Cable	3m RG-174 standard, fully customizable					
Connector	SMA(M) standard, fully customizable					

CELLULAR					
Frequency (GHz)	824 ~ 896	880 ~ 960	1710 ~ 1880	1850 ~ 1990	1710 ~ 2170
Peak Gain (dBi)	2.1	-0.2	2.9	3.0	5.1
Average (dBi)	-4.7	-7.5	-2.7	-3.1	-3.1
Efficiency	35%	20%	51%	49%	49%
Impedance	50 Ω				
Polarization	Linear				
Radiation Pattern	Omni				
Cable	3m CFD200 standard, fully customizable				
Connector	SMA(M) standard, fully customizable				



ELECTRICAL – 915Mhz			
Frequency (MHz)	902MHz	915MHz	929MHz
Gain (dBi) *	3.2	2.3	2.7
Efficiency (%) *	49	44	42
VSWR	1.92 Max		
*Including 3 meters cable loss			
Cable	3m CFD200 standard, fully customizable		
Connector	SMA(M) standard, fully customizable		

MECHANICAL	
Antenna Dimensions	Height 35.1mm(1.38”) x Diameter 145.6mm(5.73”)
Housing	UV resistant ABS
Base and thread	Zinc
Waterproof	IP67
ENVIRONMENTAL	
Operating Temperature	-40°C to 85°C
Storage Temperature	-40°C to 80°C
Humidity	Non-condensing 65°C 95% RH



3. GPS/GLONASS Antenna Characteristics

3.1 Block diagram

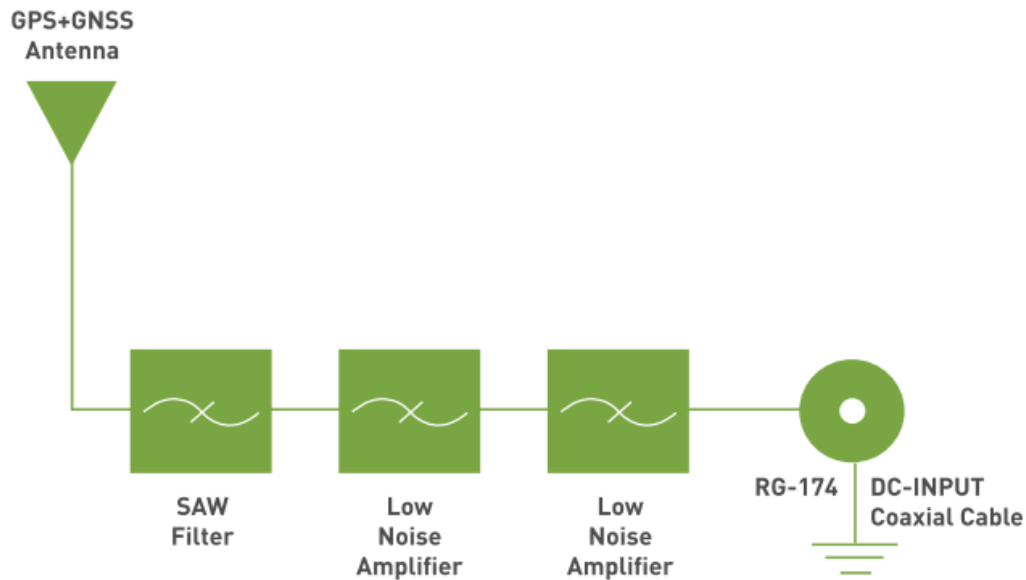

3.2 Return Loss

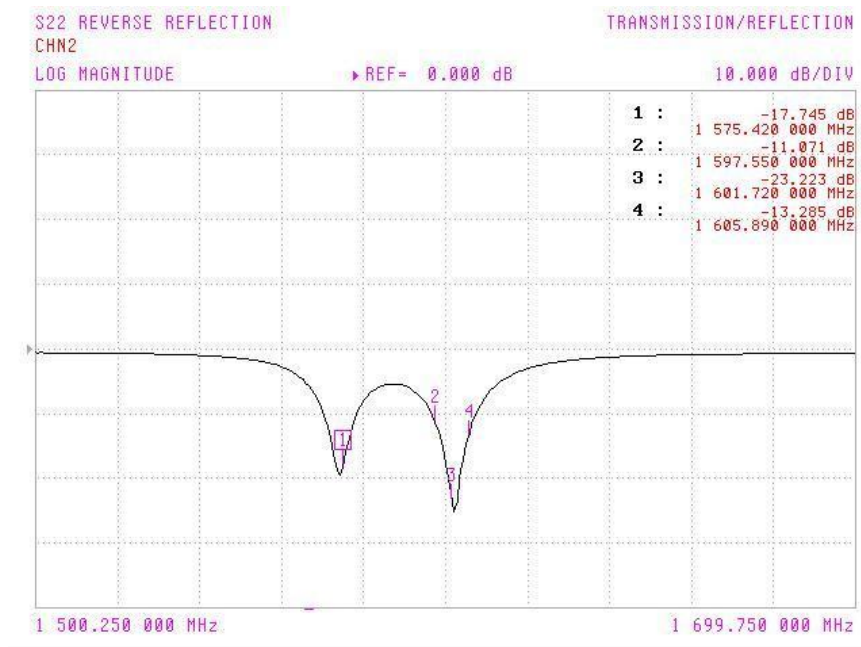

3.3 GPS/GLONASS Antenna Radiation Pattern

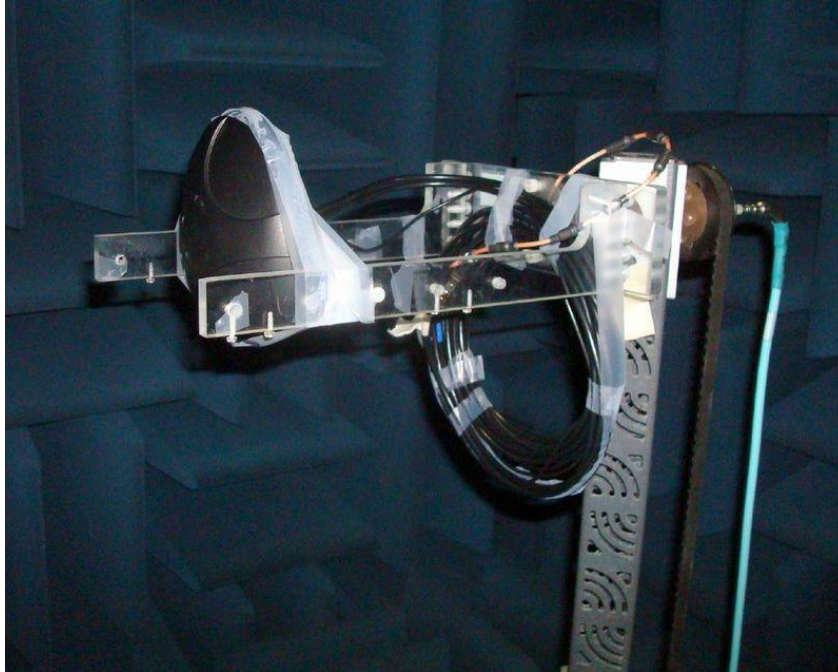

MA.600 tested in CTIA approved 3D chamber

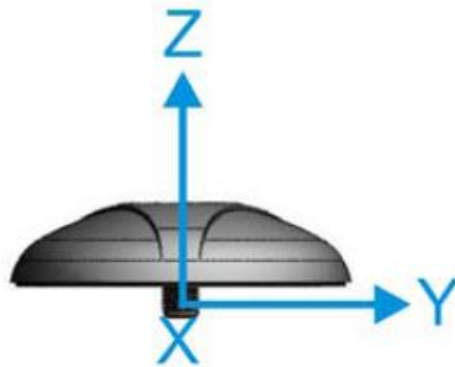

XYZ co-ordinate for reference.



3.4 Radiation Pattern

XZ-plane Free Space @1575.42MHz

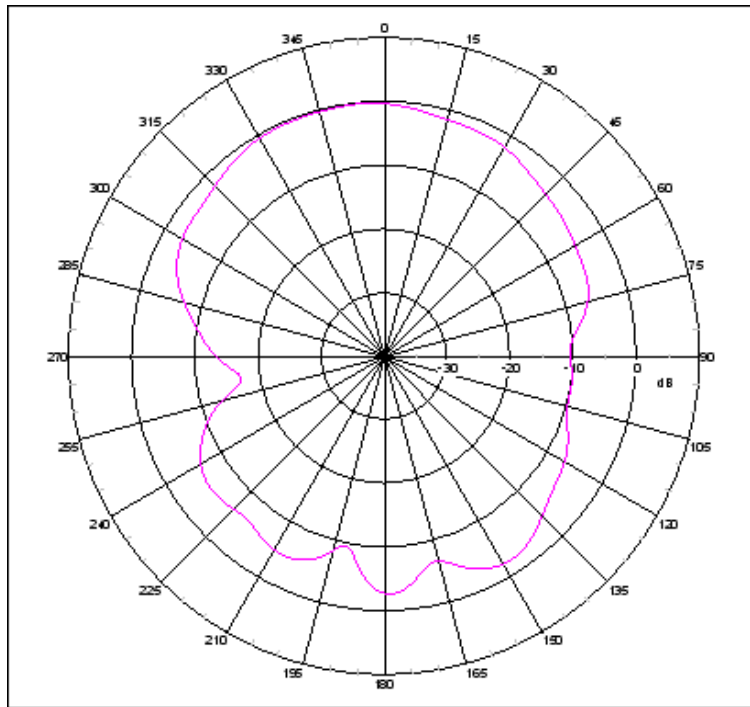

YZ-plane Free Space @1575.42MHz

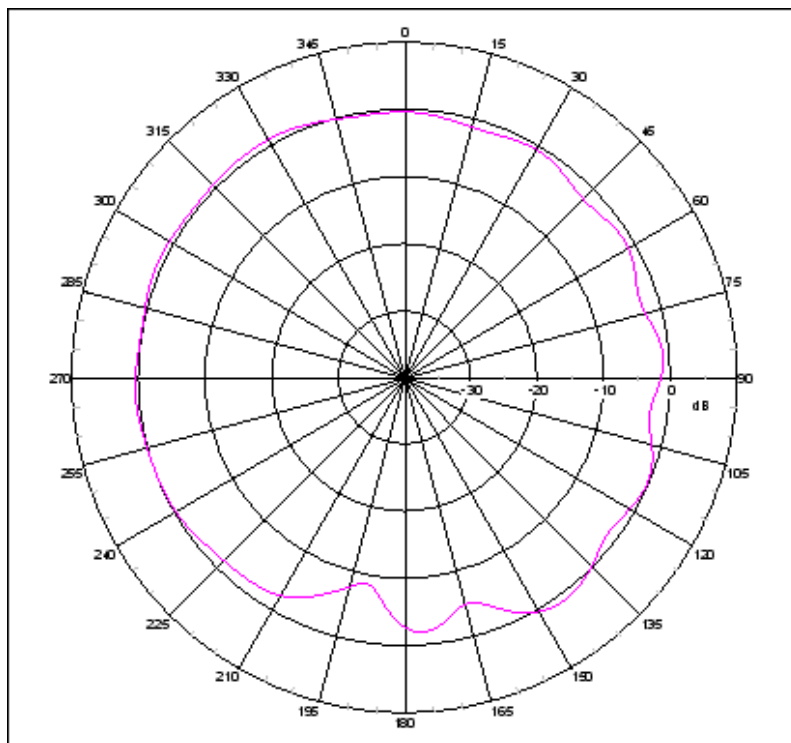



XZ-plane Free Space @1602MHz

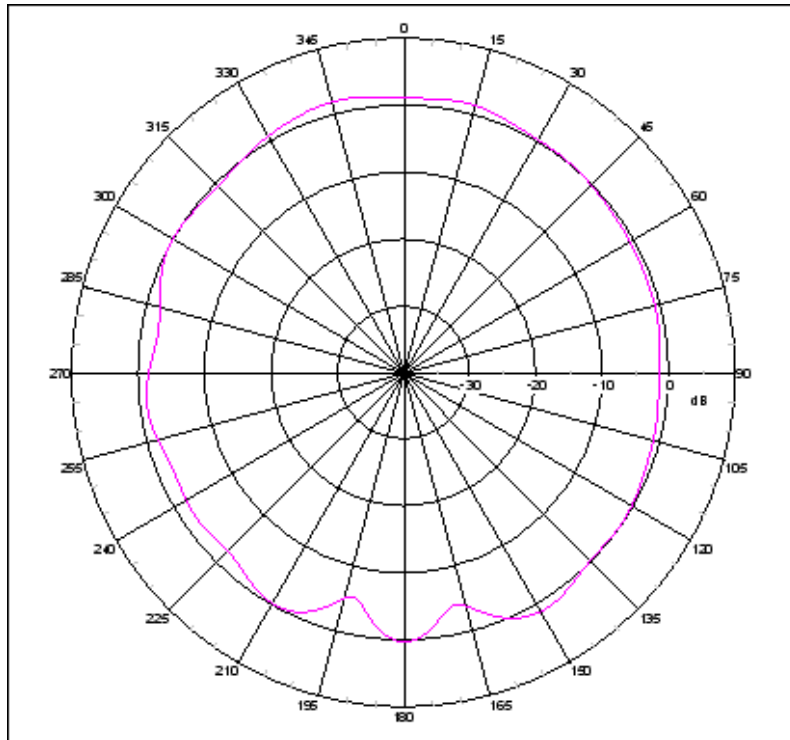

YZ-plane Free Space @1602MHz

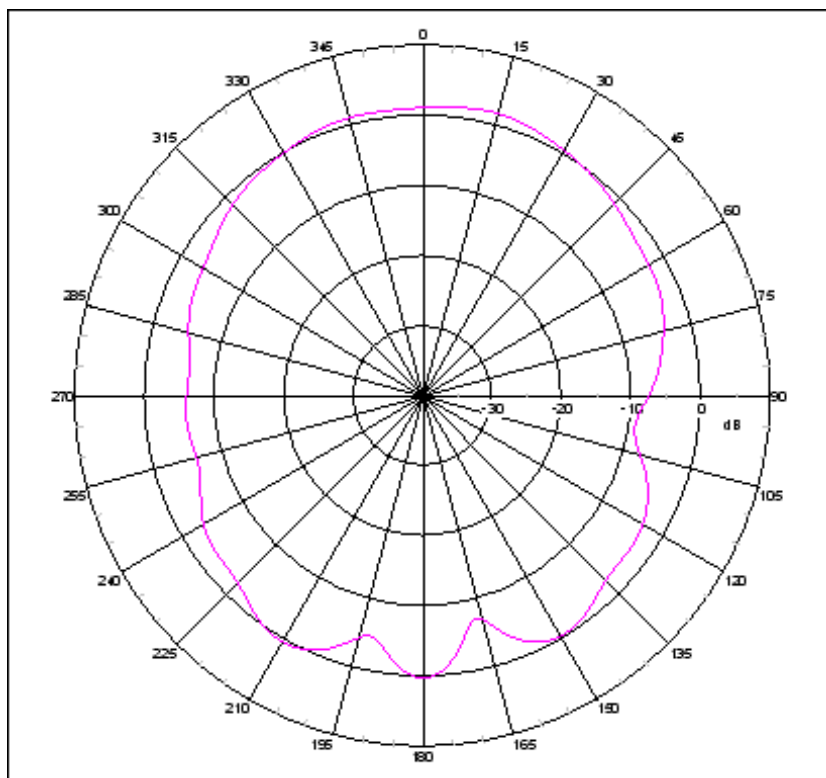



3.5 GPS/GLONASS LNA

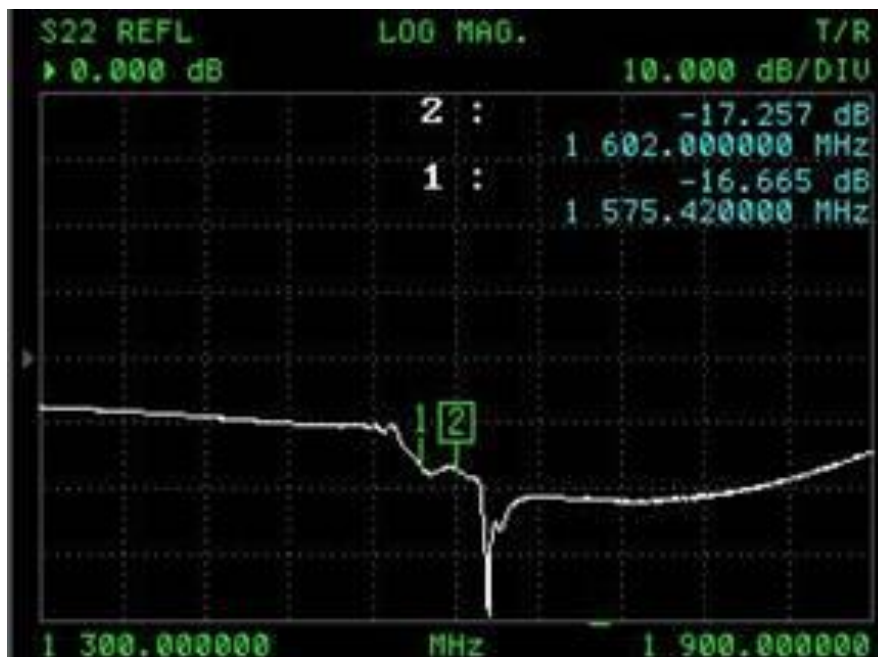
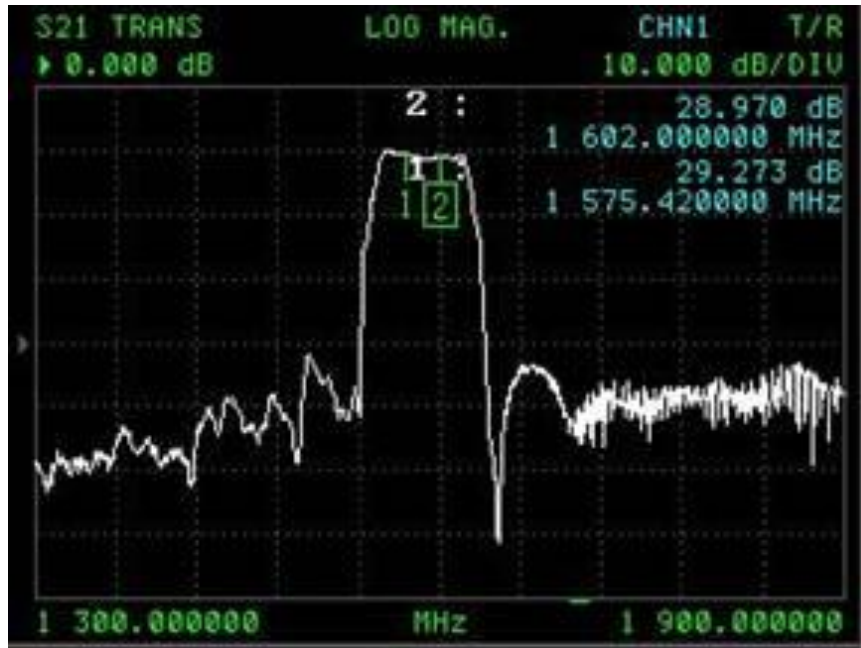

4. Cellular Antenna Characteristics

4.1 Return Loss

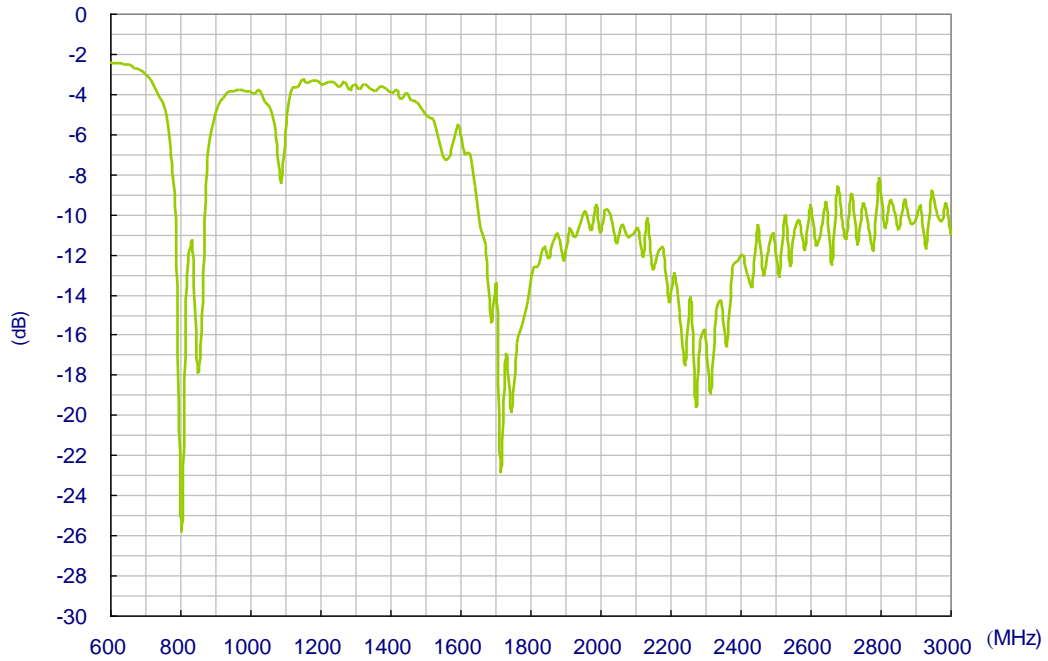

4.2 VSWR

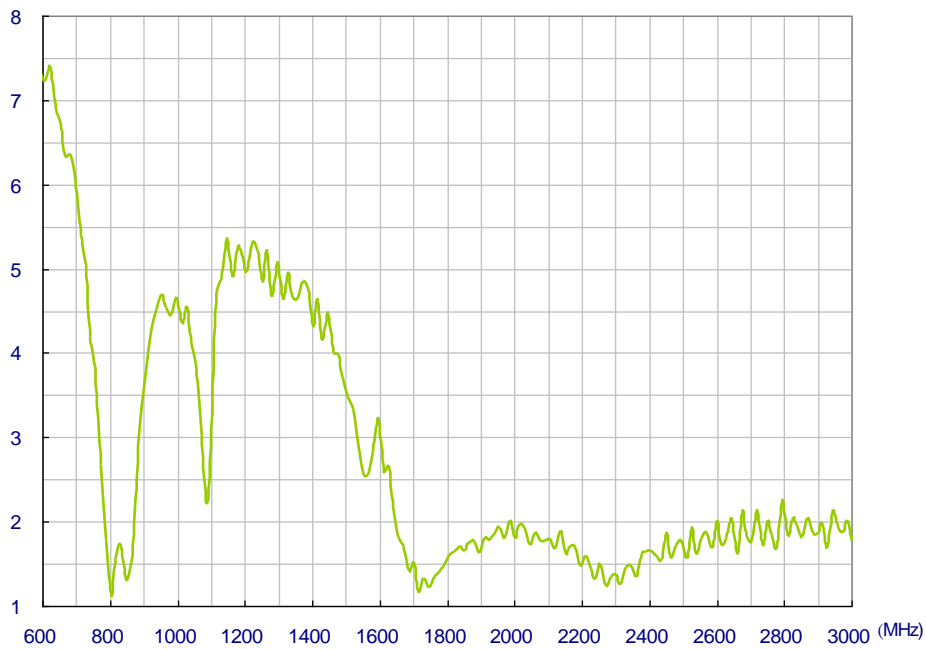

4.3 Cellular Antenna Efficiency

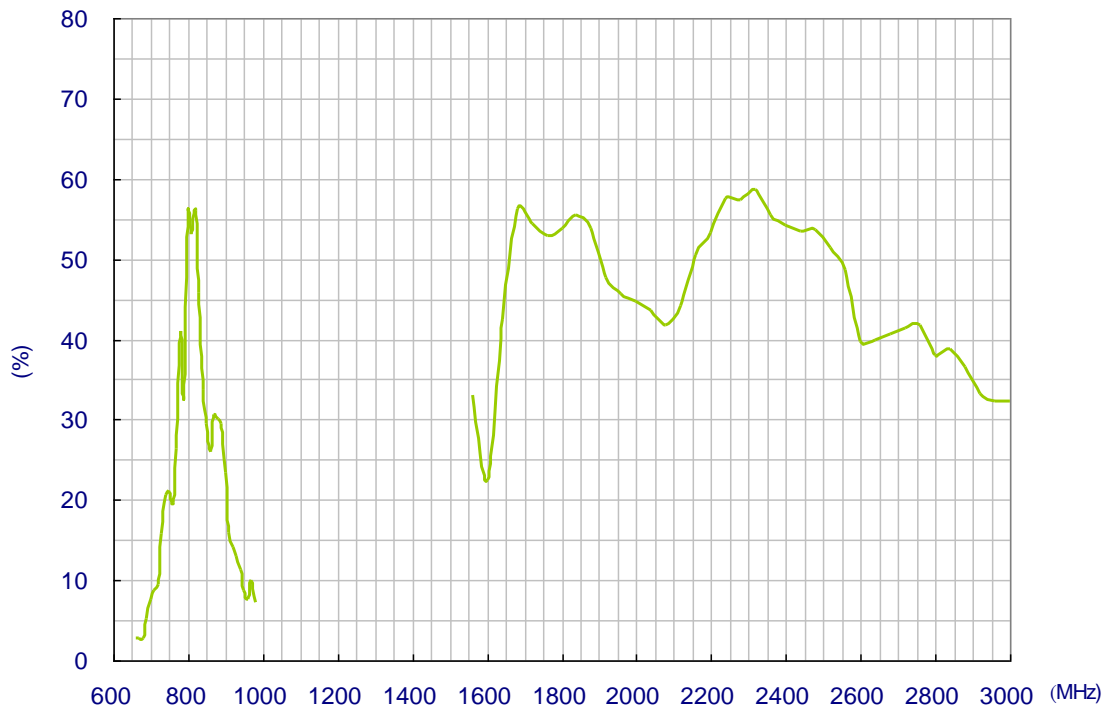

4.4 Cellular Antenna Peak Gain

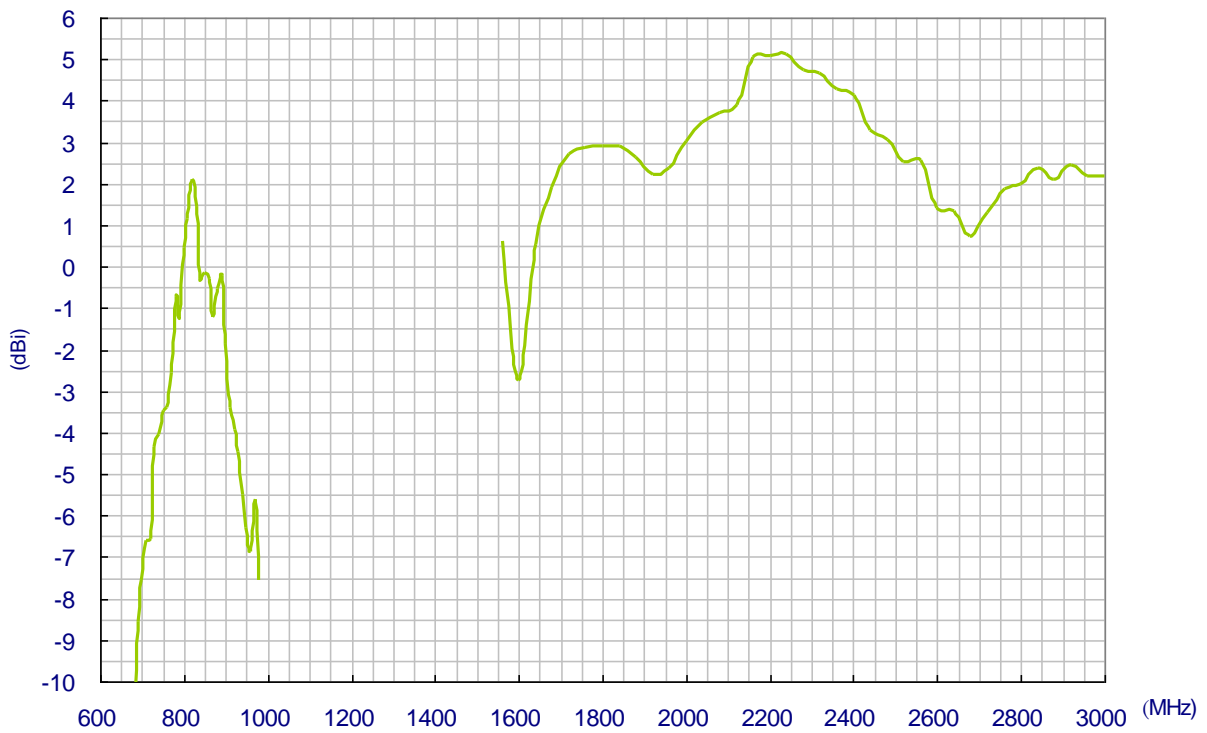

4.5 Cellular Antenna 3D Average Gain

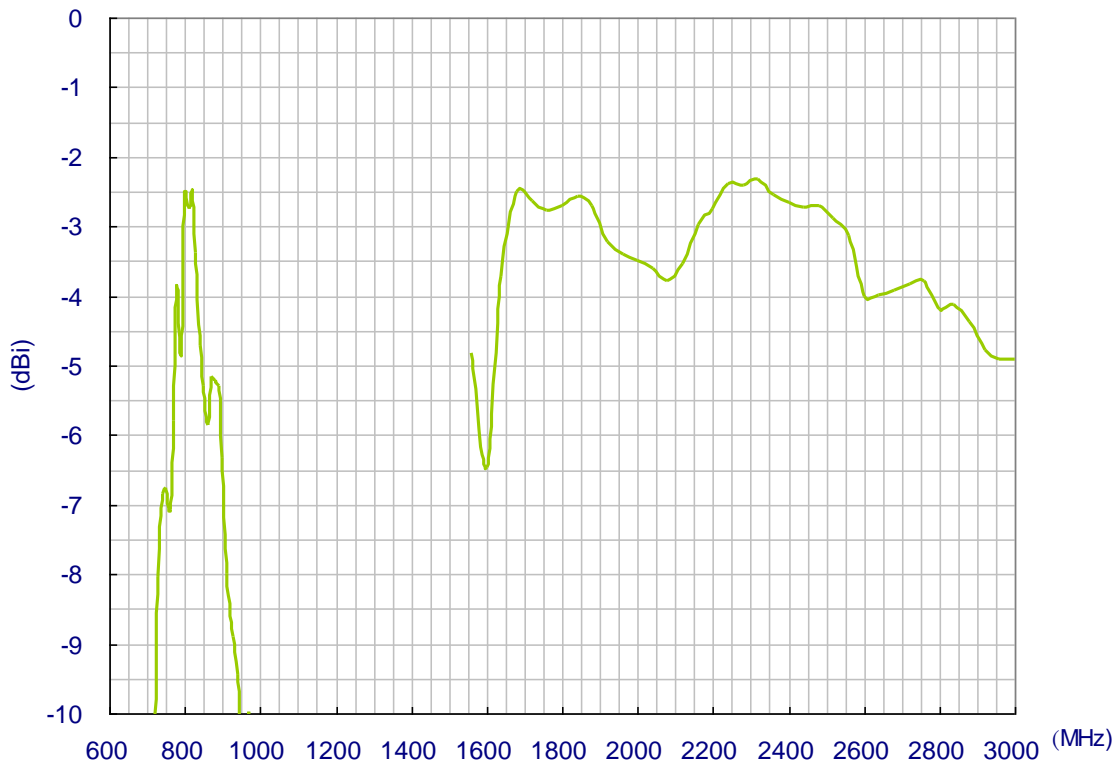

5. Cellular Antenna Radiation Pattern

5.1 XY-plane

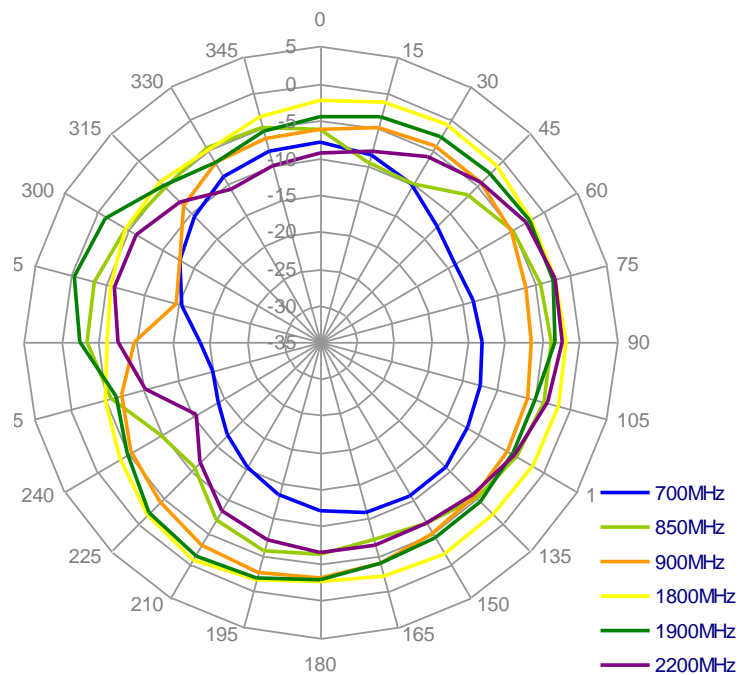



5.2 XZ-plane

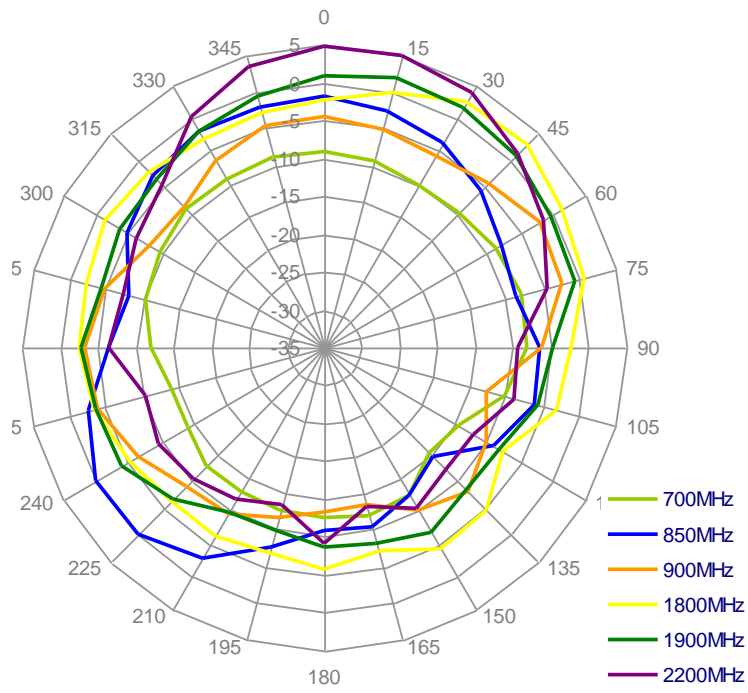

6. 915MHz Antenna

6.1 Return Loss

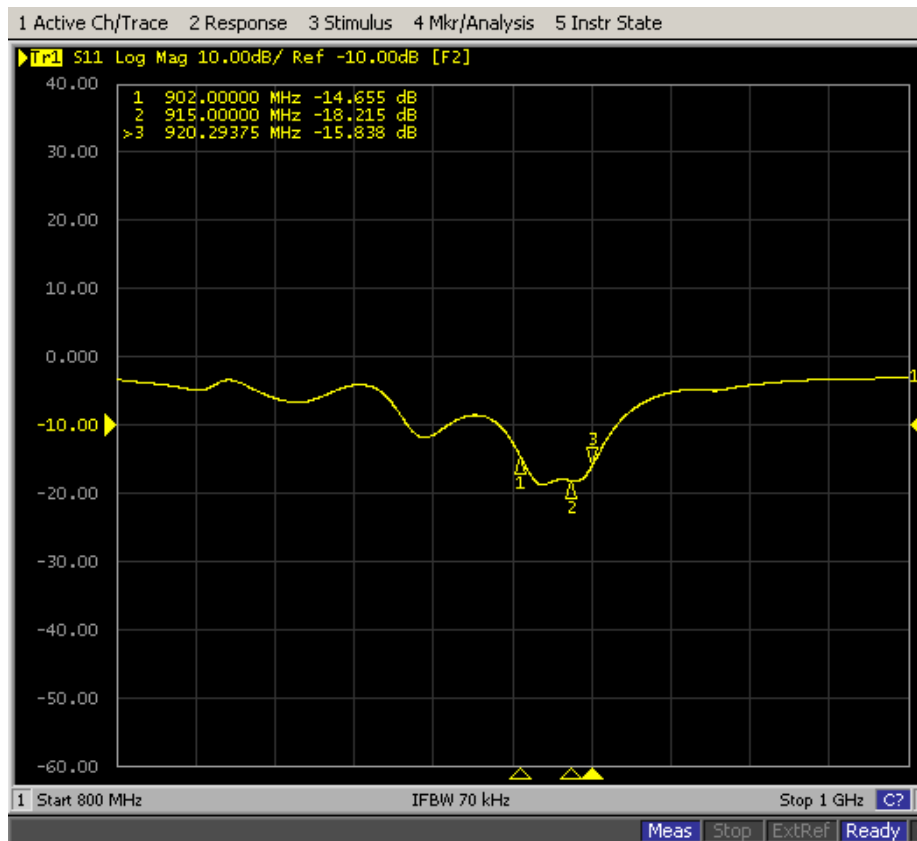

6.2 Antenna Radiation Patterns - Freespace

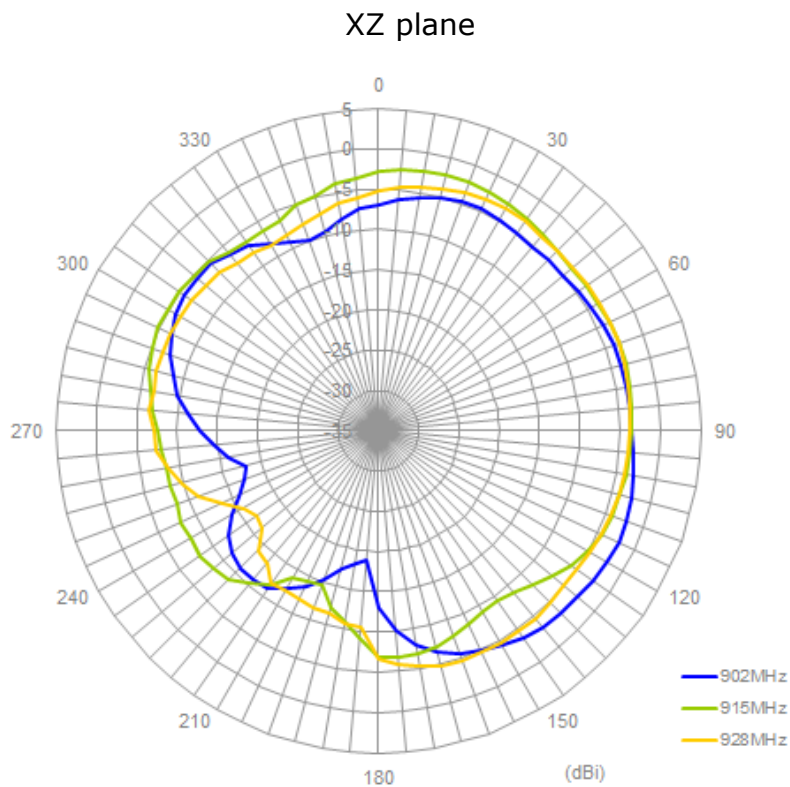
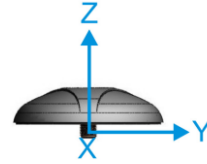
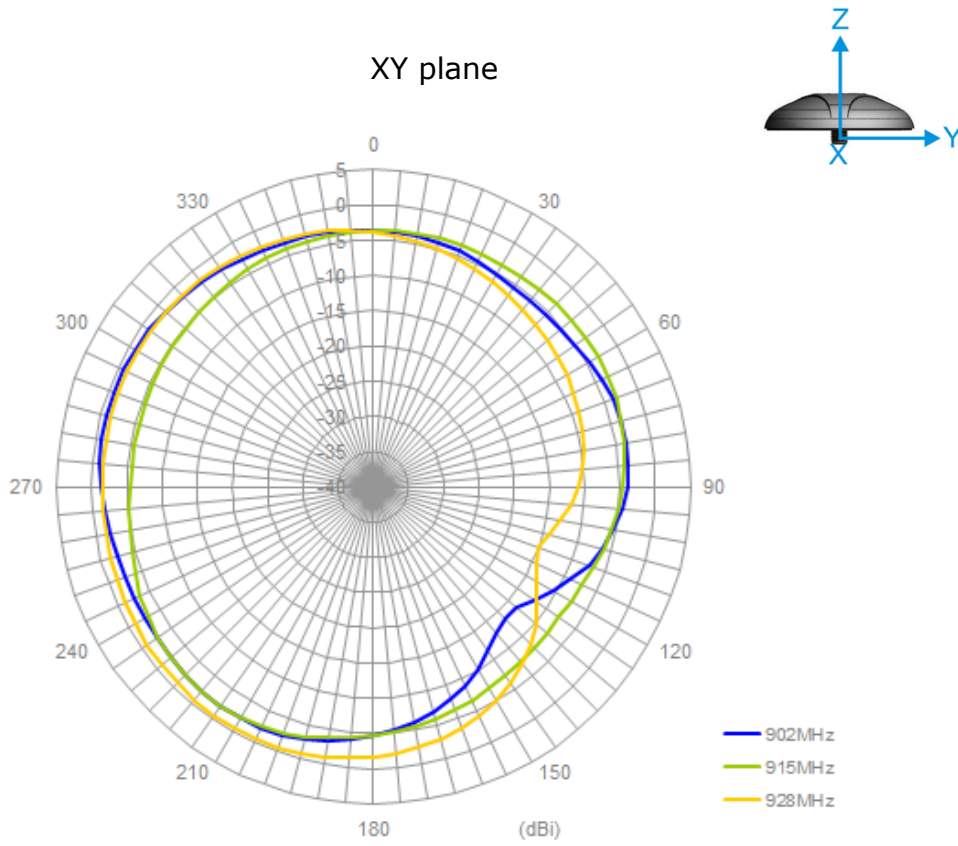



6.3 915MHz Antenna – on metal ground plane

XY plane

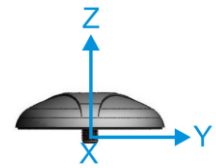
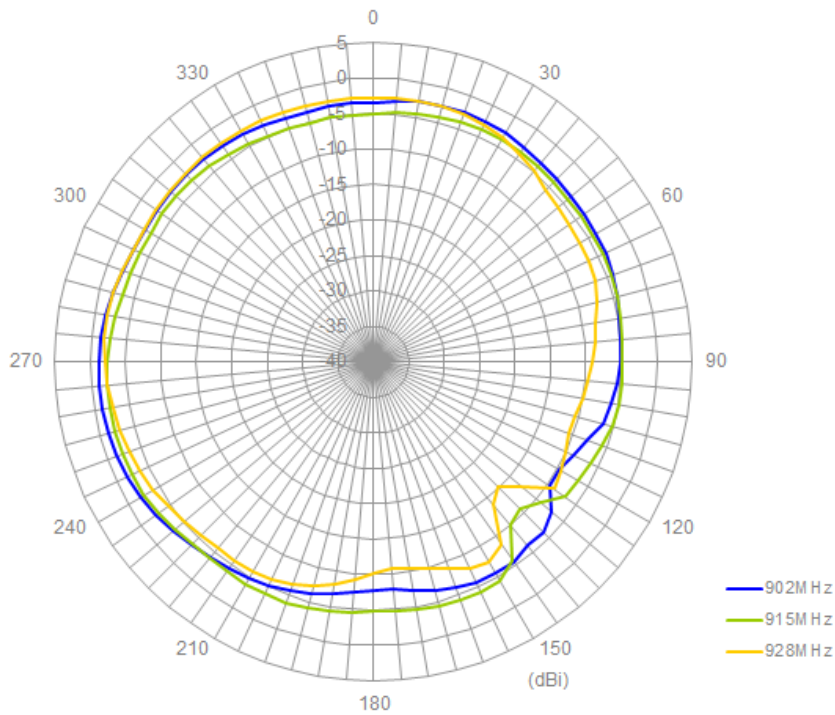

XZ plane

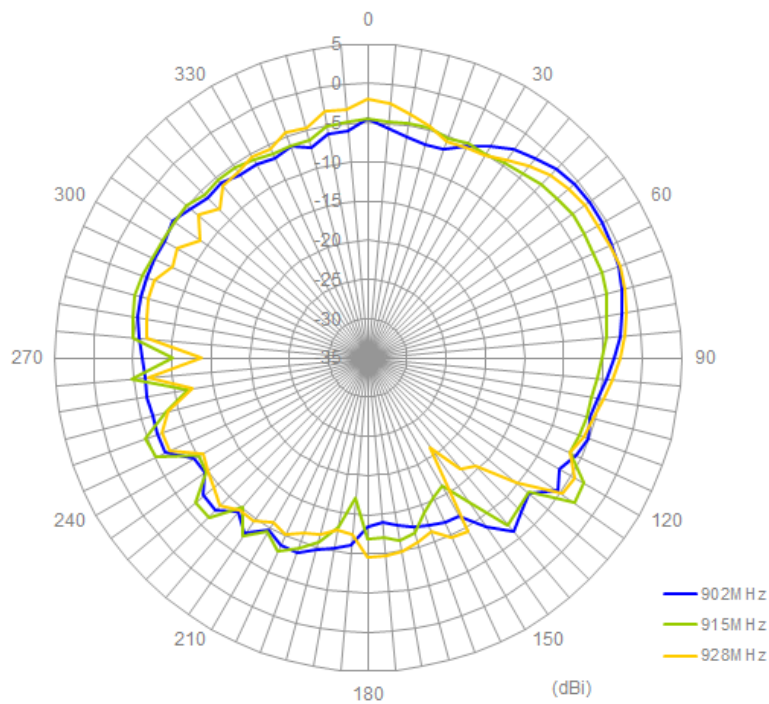



7. Mechanical Drawing

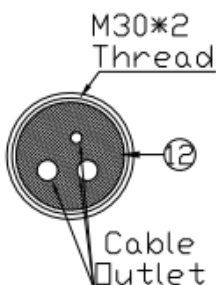
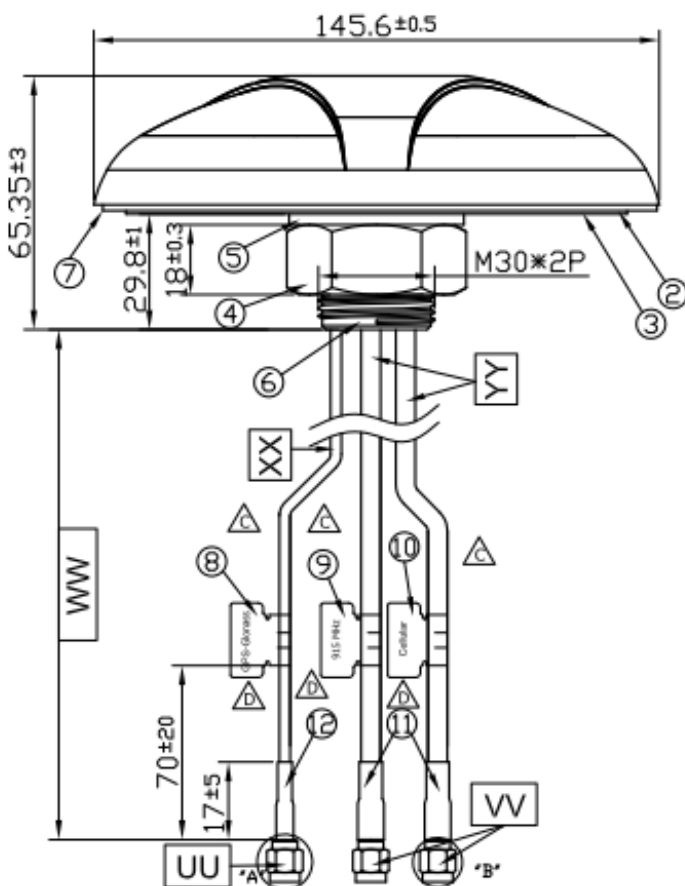
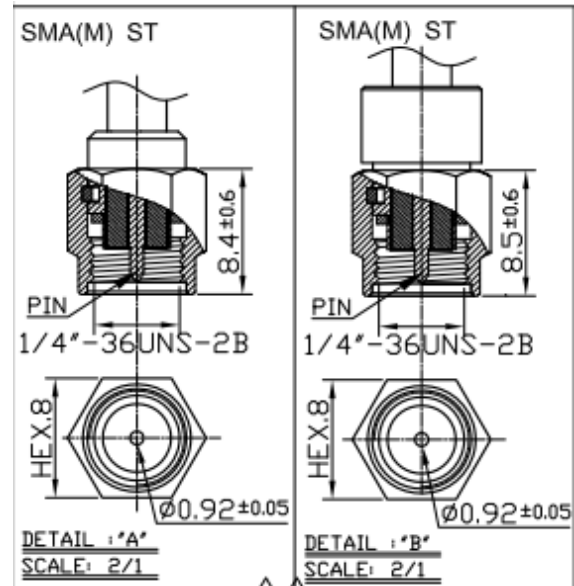
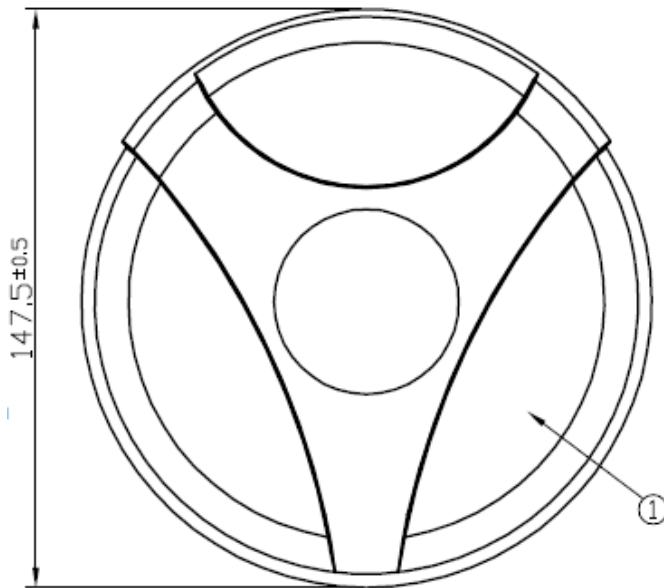

	Name	Material	Finish	QTY
1	Housing	PC 540	Black	1
2	Closed Cell Foam	CR 4305	Black	1
3	3M Double Adhesive	3M 9448 HK	White Liner	1
4	M30 Nut	Steel AISI 1215	Ni Plated	1
5	Washer	Steel AISI 1215	Ni Plated	1
6	M30x 2 Thread 32L	Zinc Alloy	Ni Plated	1
7	Waterproof Rubber	Silicon	Black	1
8	GPS-Glonass Label $\triangle C$	Gloss Silver PET	Orange	1
9	915 MHz Label $\triangle C$	Gloss Silver PET	Olive Drab	1
10	Cellular Label $\triangle C$	Gloss Silver PET	Blue	1
11	Heat Shrink Tube(CFD200)	PE	Black	2
12	Heat Shrink Tube(RG174)	PE	Black	1

	Name	Spec	Finish	QTY
UU	Connector Type	SMA(M) ST	Gold	1
VV	Connector Type	SMA(M) ST	Gold	2
WW	Cable Length	3000±120mm		1
XX	Cable Type	RG174	Black	1
YY	Cable Type	CFD 200	Black	2



8. Packaging

