



SOT-223



Pin Definition:

- 1. Input
- 2. Ground
- 3. Output

SOT-89



Pin Definition:

- 1. Ground
- 2. Input
- 3. Output

General Description

The TS9005 series is a positive voltage regulator developed utilizing CMOS technology featured low quiescent current, low dropout voltage and high output voltage accuracy. Built in low on-resistor provides low dropout voltage and large output current. A 2.2 μ F or greater can be used as an output capacitor.

The TS9005 series are prevented device failure under the worst operation condition with both thermal shutdown and current fold-back. These series are recommended for configuring portable devices and large current application, respectively.

Features

- Dropout voltage typically 0.53V @ 600mA load (3.3V)
- Output current up to 600mA
- Low quiescent current
- Output voltage trimmed before assembly
- Internal current limit
- Only need output & input capacitor

Ordering Information

Part No.	Package	Packing
TS9005 \underline{x} CW RP	SOT-223	2.5Kpcs / 13" Reel
TS9005 \underline{x} CY RM	SOT-89	1Kpcs / 7" Reel

Note: Where \underline{x} denotes voltage option, available are

D=1.8V

K=2.5V

S=3.3V

Contact factory for additional voltage options.

Applications

- PDA, Palmtops and Notebook
- Personal communication devices
- Bluetooth portable radios
- PC peripherals
- CD-ROM
- Digital signal camera

Block Diagram

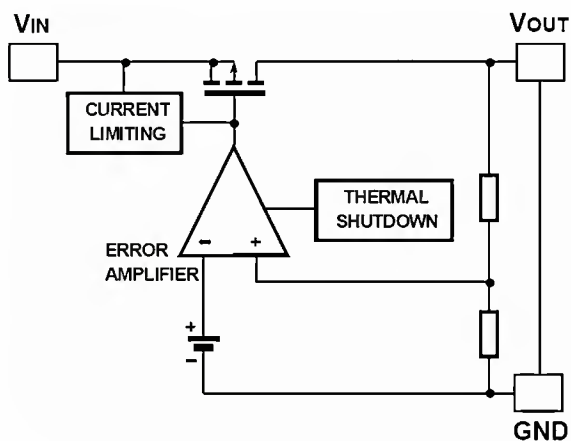

Typical Application Circuit

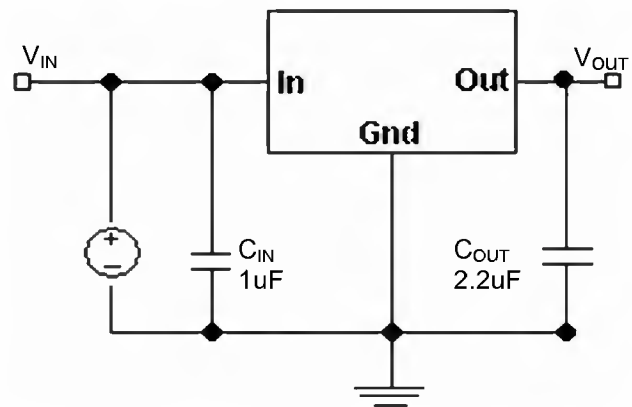

Absolute Maximum Rating

Parameter	Symbol	Limit	Unit
Supply Voltage	V_{IN}	-0.3V ~ +7	V
Input Supply Voltage (Recommended)	V_{OPR}	+2 ~ +6	V
Output Current	I_o	-0.3 to ($V_{in}+0.3$)	V
Power Dissipation	SOT-89	0.5	W
	SOT-223	0.625	
Thermal Resistance	SOT-89	180	°C /W
	SOT-223	160	
Junction Temperature Range	T_J	+150	°C
Storage Temperature Range	T_{STG}	-65 ~ +150	°C

Electrical Characteristics (Ta = 25°C unless otherwise noted.)

Parameter	Conditions	Min	Typ	Max	Unit
Output Voltage	$I_o=10mA$,	0.98 Vo	--	1.02 Vo	V
Output Voltage Temperature Coefficient		--	40	--	ppm/°C
Line Regulation	$V_{IN}=(V_o+1V)$ to 6V, $I_o=10mA$	--	0.4	--	%
Load Regulation	$1mA \leq I_L \leq 600mA$	--	1.7	--	%
Dropout Voltage	$V_{OUT}=3.3V$, $I_o=600mA$	--	530	--	mV
	$V_{OUT}=2.5V$, $I_o=600mA$	--	600	--	
	$V_{OUT}=1.8V$, $I_o=600mA$	--	850	--	
Ground Current	$I_o=0mA$	--	100	160	uA
Short Circuit Current	$V_{OUT} < 0.4V$	--	420	--	mA
Power Supply Rejection Ratio	f=1KHz, $I_o=10mA$	--	43	--	dB
	f=1KHz, $I_o=10mA$	--	43	--	
	f=1KHz, $I_o=10mA$	--	42	--	
Thermal Shutdown		--	160	--	°C

Notes:

a. The drop out voltage varies depending on output voltage selection

Dropout is defined as $V_{IN} - V_{OUT}$ when V_{OUT} is 100mV below V_{OUT} where $V_{IN} = V_{OUT} + 1V$ for nominal V_{OUT}

b. Time needed for V_{OUT} to reach 90% of final value

Application Information

Input / Output Capacitor

It is recommended to use a 0.47 μ F capacitor on the TS9005/A input and a 0.47 μ F capacitor on the output. For high regulation performance, larger input capacitor values and lower ESRs provide better noise rejection and line-transient response. The output noise, load-transient response, stability, and power-supply rejection can be improved by using large output capacitors. Low ESR ceramic capacitors provide optimal performance and save space.

Power Supply Rejection and Transient Response

The PSRR and transient response can be improved by increasing the values of the input and output bypass capacitors, and through passive filtering techniques

Function Description

Description

The TS9005/A is an ultra-low-noise, low-quiescent current, low-dropout linear regulator. It is supplied in a SOT-25 package for difference applications. This device can supply loads up to 600mA. As shown in the functional block diagram, the TS9005/A consists of a reference and noise bypass circuit, error amplifier, output drive transistor, internal feedback voltage divider, thermal sensor, and short circuit current limiter. The internal reference is connected to the error amplifier's inverting input. The error amplifier compares this reference with the feedback voltage and amplifies the difference. If the feedback voltage is lower than the reference voltage, the pass transistor gate is pulled low. This allows more current to pass to the output and increases the output voltage.

Stability

The TS9005/A is a high performance LDO emphasizing stability with low output capacitance. It is able to maintain stability with an output capacitor can also be increased to optimize performance. The TS9005/A will remain stable and in regulation with no load, unlike many other voltage regulators.

Internal P-Channel Pass Transistor

The TS9005/A features a low impedance P-channel MOSFET pass transistor. This provides several advantages over similar designs using a PNP pass transistor, including low operating power and longer battery life. The TS9005/A consumes only 100 μ A of quiescent current under most conditions.

Output Short-Circuit Current Limit

The TS9005/A includes a current limiter, which monitors and controls the pass transistor's gate voltage, limiting the output current to about 420mA, for example, in a short-circuit output situation.

Shutdown

The TS9005/A also features a low-power active shutdown mode. It has a switch that turns off the device when disabled. This allows the output capacitor and load to discharge and de-energize the load. In the shutdown mode, the internal functional blocks, such as voltage reference and the error amplifier, are turned off completely, and the quiescent current is less than 1 μ A.

Thermal Protection Shutdown

The thermal protection shutdown function protects the device from operating in over temperature condition. When the junction temperature exceeds +160 $^{\circ}$ C, the thermal sensor signals the shutdown logic, turning off the pass transistor and allowing the IC to cool down. The thermal sensor turns the pass transistor on again after the IC's junction temperature drops to +140 $^{\circ}$ C.

Soft-Start Circuitry

The TS9005/A includes a soft-start circuitry to limit inrush current at turn-on. During power up, the output capacitor and output load are charged with a reduce output current. Shortly after the initial power up, the soft-start feature is terminated and normal operation is resumed.

Electrical Characteristics Curve

Dropout Voltage vs. Load Current

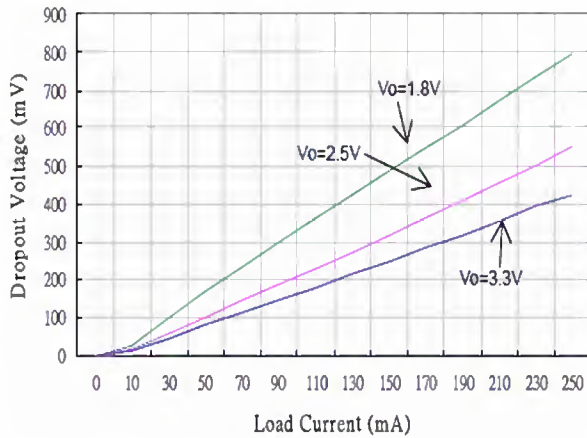

Dropout Voltage vs. Temperature

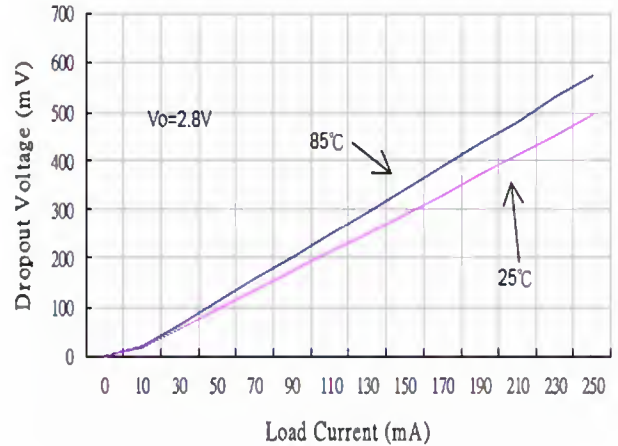

Ground Current vs. Input Voltage

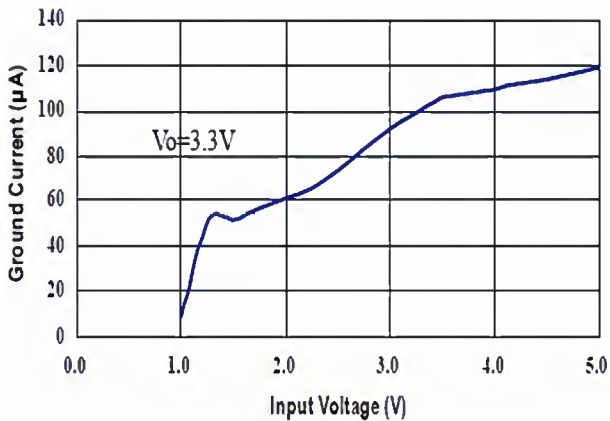

Output Voltage vs. Temperature

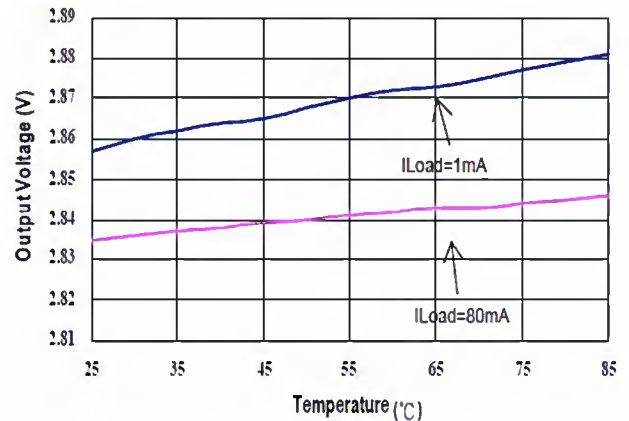

PSRR vs. Frequency

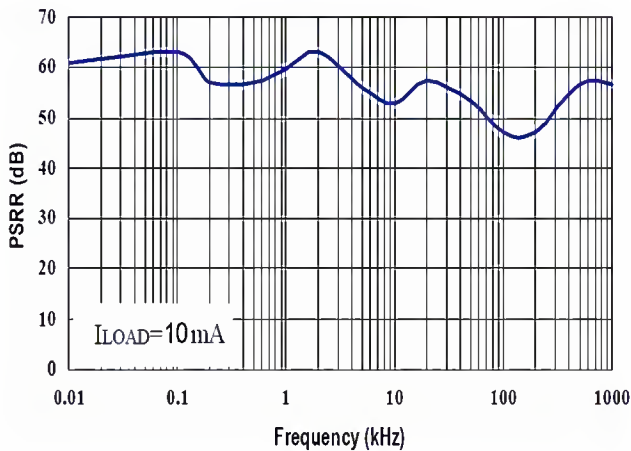

PSRR vs. Frequency

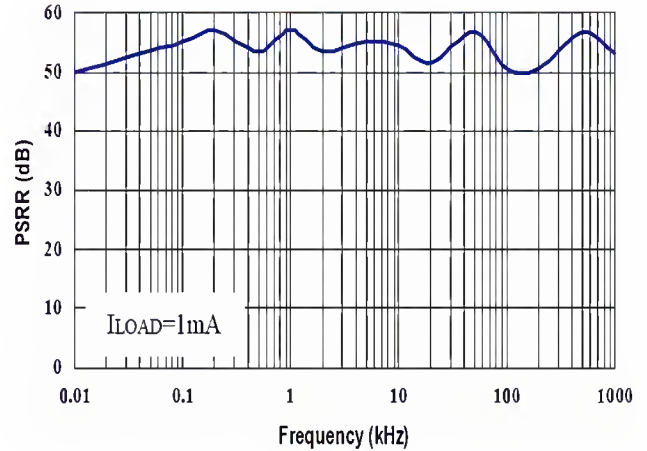

SOT-223 Mechanical Drawing

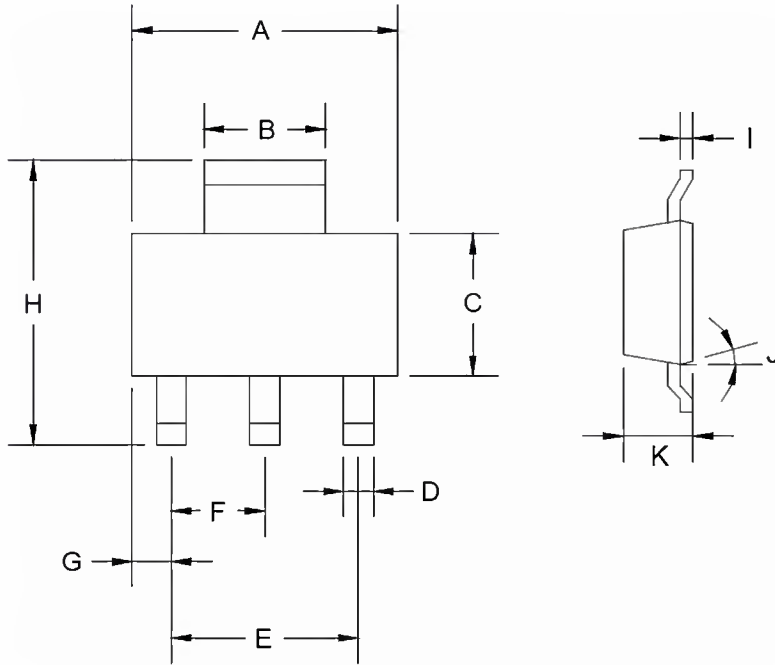

DIM	SOT-223 DIMENSION			
	MILLIMETERS		INCHES	
	MIN	MAX	MIN	MAX
A	6.350	6.850	0.250	0.270
B	2.900	3.100	0.114	0.122
C	3.450	3.750	0.136	0.148
D	0.595	0.635	0.023	0.025
E	4.550	4.650	0.179	0.183
F	2.250	2.350	0.088	0.093
G	0.835	1.035	0.032	0.041
H	6.700	7.300	0.263	0.287
I	0.250	0.355	0.010	0.014
J	10°	16°	10°	16°
K	1.550	1.800	0.061	0.071

Marking Diagram

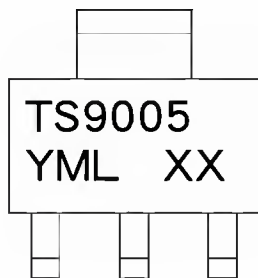

- A** = Device Code
- Y** = Year Code
- M** = Month Code
(**A**=Jan, **B**=Feb, **C**=Mar, **D**=Apr, **E**=May, **F**=Jun, **G**=Jul, **H**=Aug, **I**=Sep, **J**=Oct, **K**=Nov, **L**=Dec)
- L** = Lot Code
- XX** = Fixed Output Voltage Code
D=1.8V, **K**=2.5V, **S**=3.3V

SOT-89 Mechanical Drawing

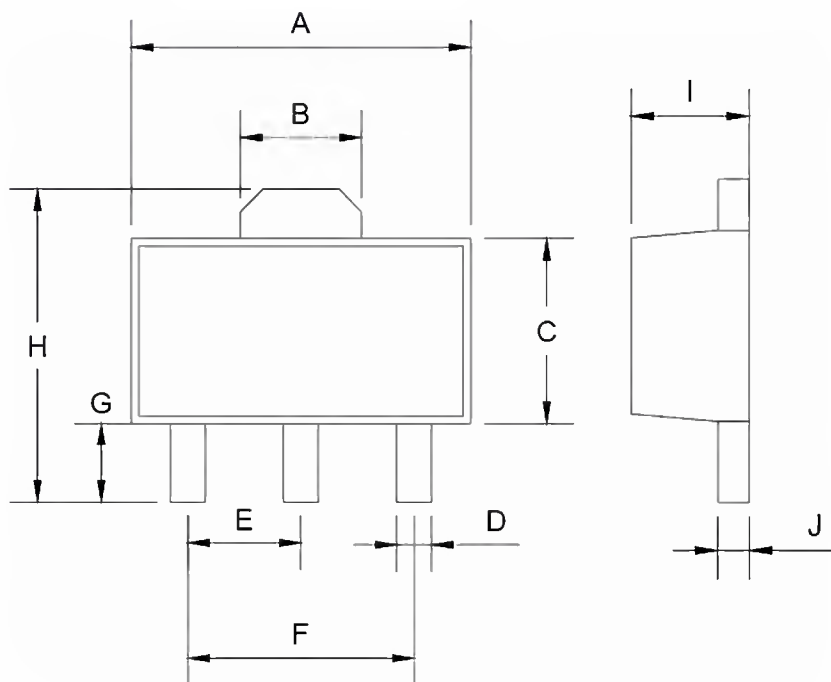

SOT-89 DIMENSION				
DIM	MILLIMETERS		INCHES	
	MIN	MAX	MIN	MAX
A	4.40	4.60	0.173	0.181
B	1.50	1.7	0.059	0.070
C	2.30	2.60	0.090	0.102
D	0.40	0.52	0.016	0.020
E	1.50	1.50	0.059	0.059
F	3.00	3.00	0.118	0.118
G	0.89	1.20	0.035	0.047
H	4.05	4.25	0.159	0.167
I	1.4	1.6	0.055	0.068
J	0.35	0.44	0.014	0.017

Marking Diagram

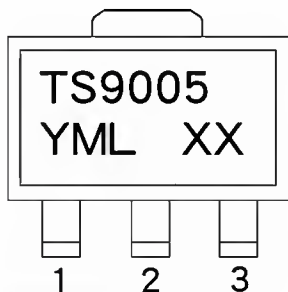

- A** = Device Code
- Y** = Year Code
- M** = Month Code
 (A=Jan, B=Feb, C=Mar, D=Apl, E=May, F=Jun, G=Jul, H=Aug, I=Sep, J=Oct, K=Nov, L=Dec)
- L** = Lot Code
- XX** = Fixed Output Voltage Code
 D=1.8V, K=2.5V, S=3.3V

Notice

Specifications of the products displayed herein are subject to change without notice. TSC or anyone on its behalf, assumes no responsibility or liability for any errors or inaccuracies.

Information contained herein is intended to provide a product description only. No license, express or implied, to any intellectual property rights is granted by this document. Except as provided in TSC's terms and conditions of sale for such products, TSC assumes no liability whatsoever, and disclaims any express or implied warranty, relating to sale and/or use of TSC products including liability or warranties relating to fitness for a particular purpose, merchantability, or infringement of any patent, copyright, or other intellectual property right.

The products shown herein are not designed for use in medical, life-saving, or life-sustaining applications. Customers using or selling these products for use in such applications do so at their own risk and agree to fully indemnify TSC for any damages resulting from such improper use or sale.