

30V P-Channel Logic Level Enhancement Mode MOSFET

MTF44P03N3

BV_{DSS}	-30V
$R_{DSON(Max)}$	44m Ω
I_D	-4A

Features

- Lower gate charge
- Pb-free lead plating and Halogen-free package

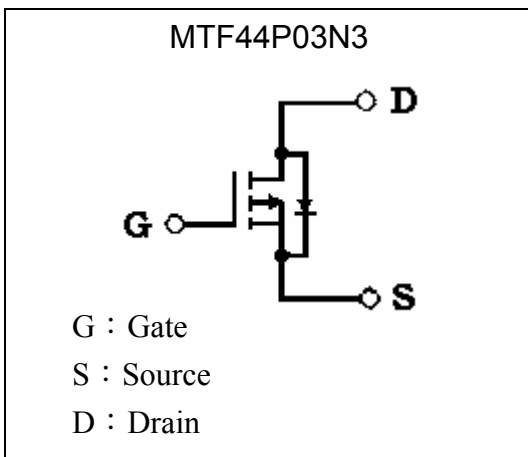
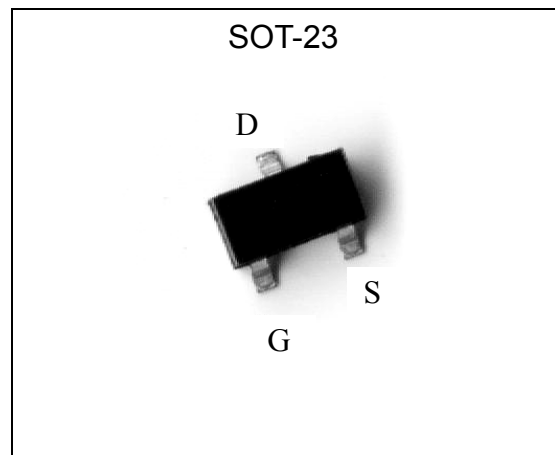
Equivalent Circuit

Outline

Absolute Maximum Ratings ($T_c=25^\circ\text{C}$, unless otherwise noted)

Parameter	Symbol	Limits	Unit	
Drain-Source Voltage	V_{DS}	-30	V	
Gate-Source Voltage	V_{GS}	± 12	V	
Continuous Drain Current	I_D	$T_A=25^\circ\text{C}$	-4	A
		$T_A=70^\circ\text{C}$	-3	
Pulsed Drain Current	I_{DM}	-16 (Note 1 & 2)	A	
Power Dissipation	P_D	$T_A=25^\circ\text{C}$	1.5 (Note 3)	W
		$T_A=70^\circ\text{C}$	1 (Note 3)	
Thermal Resistance, Junction to Ambient	$R_{th, j-a}$	100 (Note 3)	$^\circ\text{C/W}$	
Operating Junction and Storage Temperature	T_j, T_{stg}	-55 ~ +175	$^\circ\text{C}$	

Note : 1. Pulse width limited by maximum junction temperature

 2. Duty cycle $\leq 1\%$

 3. Surface mounted on 1 in² copper pad of FR4 board; 270 $^\circ\text{C/W}$ when mounted on min. copper pad



Electrical Characteristics ($T_A=25^{\circ}\text{C}$, unless otherwise specified)

Symbol	Min.	Typ.	Max.	Unit	Test Conditions
Static					
BV_{DSS}	-30	-	-	V	$V_{GS}=0, I_D=-250\mu\text{A}$
$V_{GS(th)}$	-0.3	-0.75	-1.2	V	$V_{DS}=V_{GS}, I_D=-250\mu\text{A}$
I_{GSS}	-	-	± 100	nA	$V_{GS}=\pm 12\text{V}, V_{DS}=0$
I_{DSS}	-	-	-1	μA	$V_{DS}=-24\text{V}, V_{GS}=0$
	-	-	-10	μA	$V_{DS}=-20\text{V}, V_{GS}=0, T_j=125^{\circ}\text{C}$
I_{DON}^1	-4	-	-	A	$V_{DS}=-5\text{V}, V_{GS}=-4.5\text{V}$
$*R_{DS(ON)}^1$	-	32	38	m Ω	$I_D=-4.5\text{A}, V_{GS}=-10\text{V}$
	-	39	44		$I_D=-4\text{A}, V_{GS}=-4.5\text{V}$
	-	60	75		$I_D=-3\text{A}, V_{GS}=-2.5\text{V}$
$*G_{FS}^1$	-	13	-	S	$V_{DS}=-5\text{V}, I_D=-4\text{A}$
Dynamic					
C_{iss}	-	1079	-	pF	$V_{DS}=-15\text{V}, V_{GS}=0, f=1\text{MHz}$
C_{oss}	-	116	-		
C_{rSS}	-	93	-		
$*t_{d(ON)}^{1\ 2}$	-	6	-	ns	$V_{DS}=-15\text{V}, I_D=-1\text{A}, V_{GS}=-4.5\text{V}, R_G=6\Omega$
$*t_r^{1\ 2}$	-	7	-		
$*t_{d(OFF)}^{1\ 2}$	-	45	-		
$*t_f^{1\ 2}$	-	15	-		
$*Q_g^{1\ 2}$	-	10	-	nC	$V_{DS}=-15\text{V}, I_D=-4\text{A}, V_{GS}=-4.5\text{V}$
$*Q_{gs}^{1\ 2}$	-	1.5	-		
$*Q_{gd}^{1\ 2}$	-	3.5	-		
Source-Drain Diode					
I_S	-	-	-2	A	
I_{SM}^3	-	-	-8		
V_{SD}^1	-	-	-1.2	V	$I_F=I_S, V_{GS}=0\text{V}$

¹ Pulse test : Pulse width $\leq 300\mu\text{s}$, Duty cycle $\leq 2\%$

² Independent of operating temperature

³ Pulse width limited by maximum junction temperature

Ordering Information

Device	Package	Shipping	Marking
MTF44P03N3	SOT-23 (Pb-free)	3000 pcs / Tape & Reel	26

Characteristic Curves

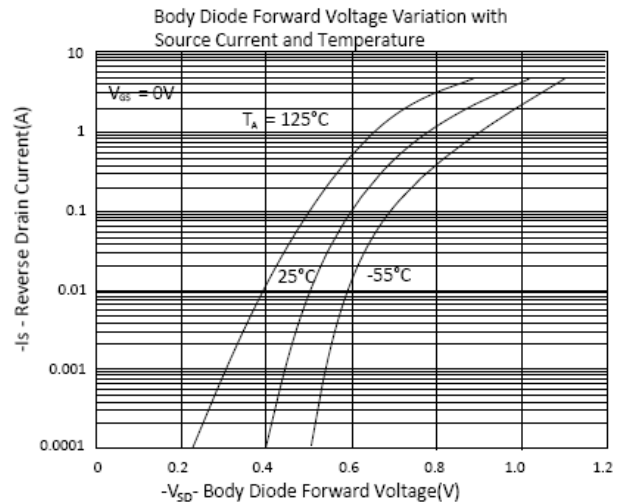
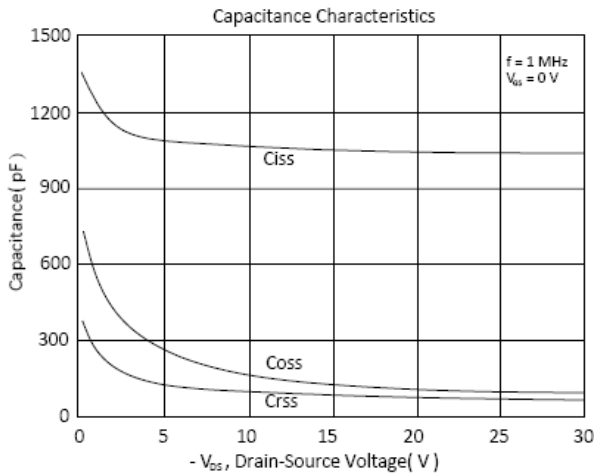
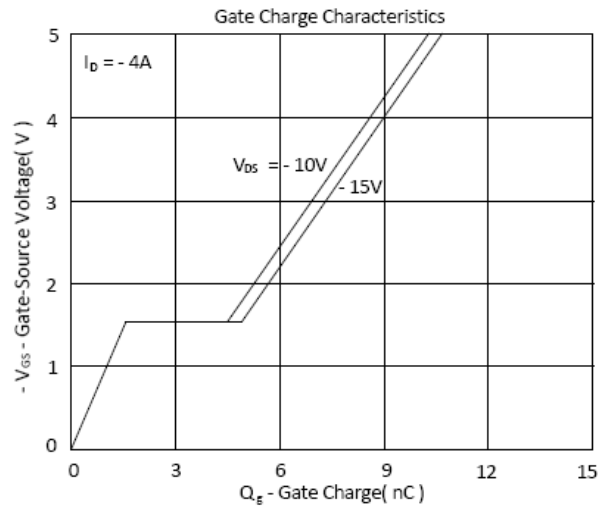
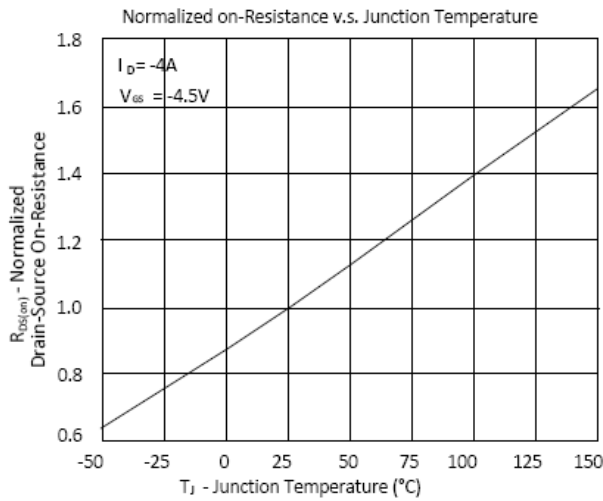
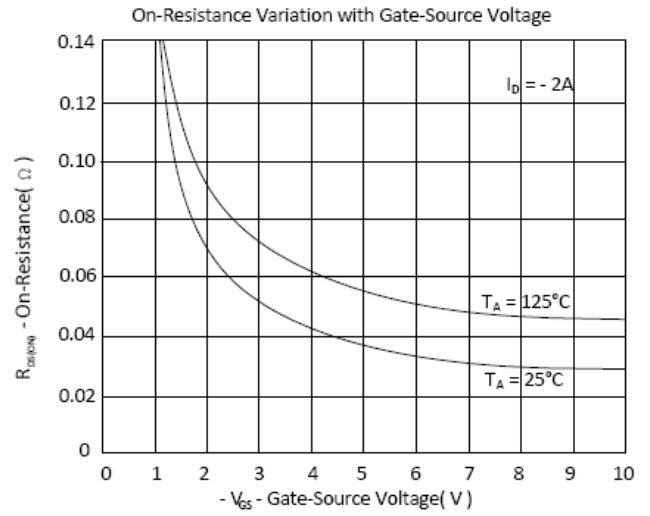
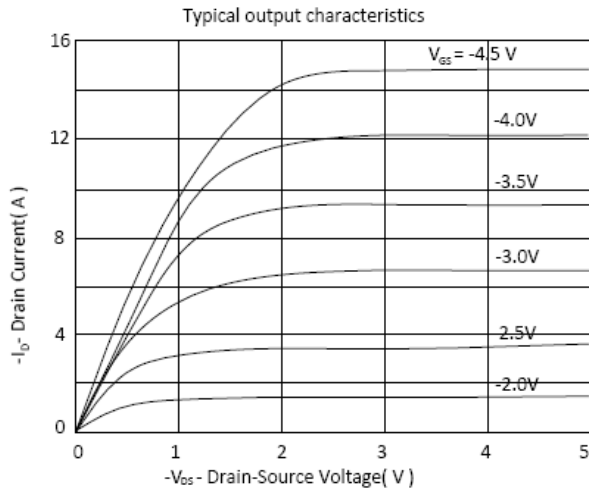



Characteristic Curves(Cont.)

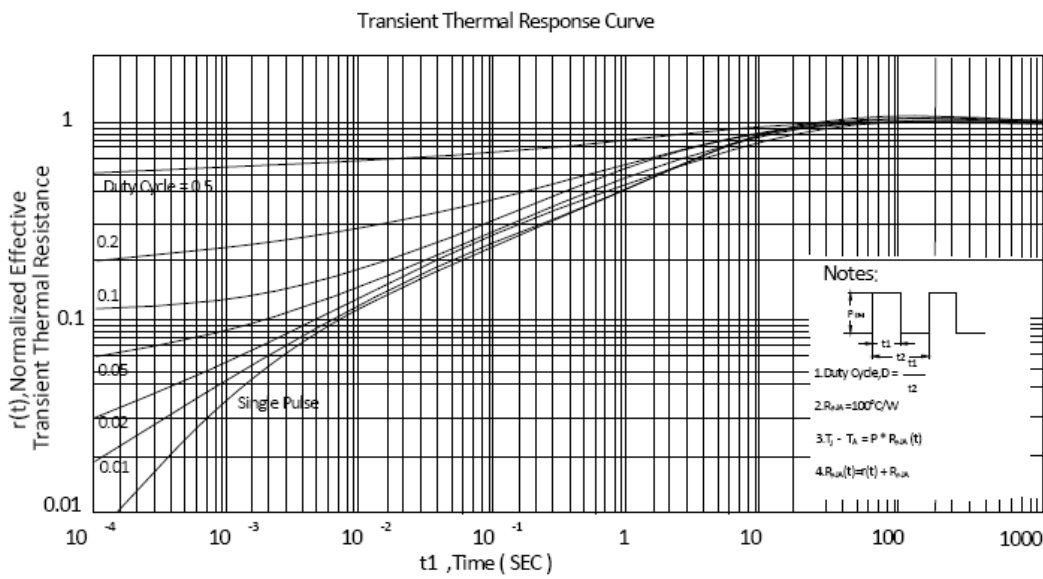
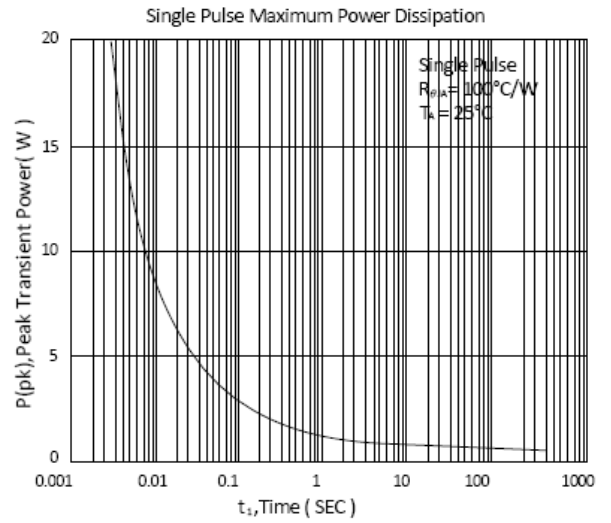
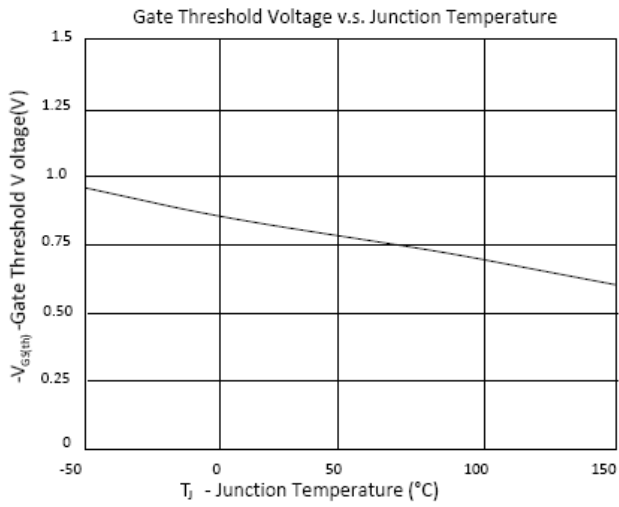

Reel Dimension

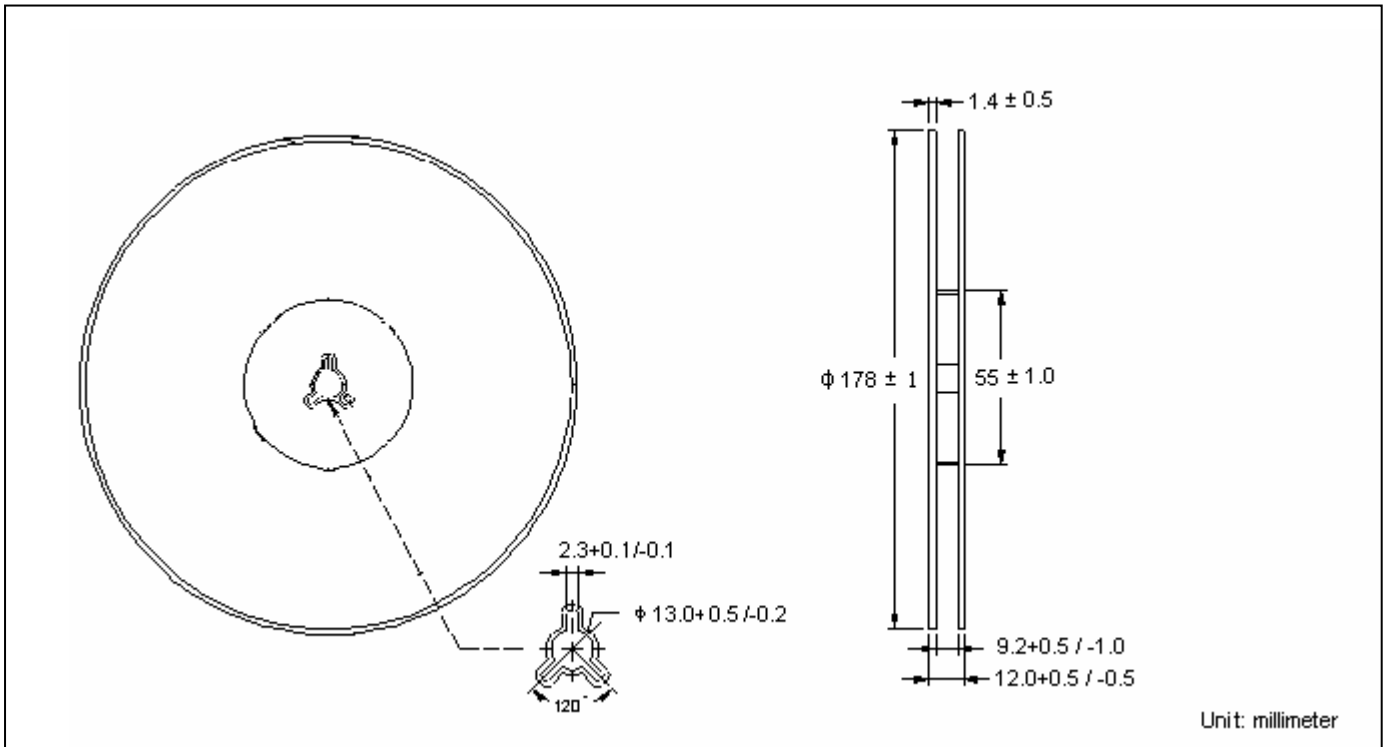

Carrier Tape Dimension

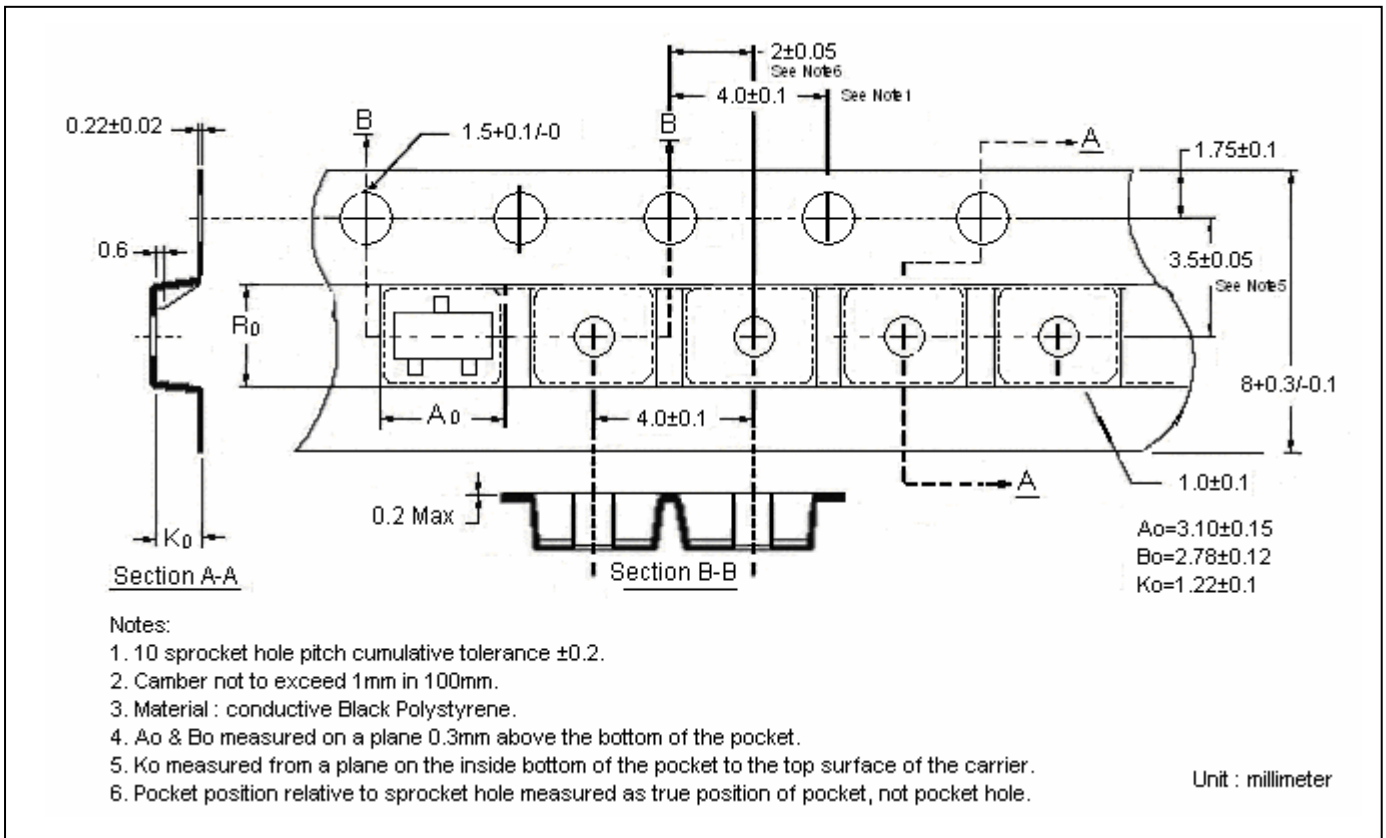

Recommended wave soldering condition

Product	Peak Temperature	Soldering Time
Pb-free devices	260 +0/-5 °C	5 +1/-1 seconds

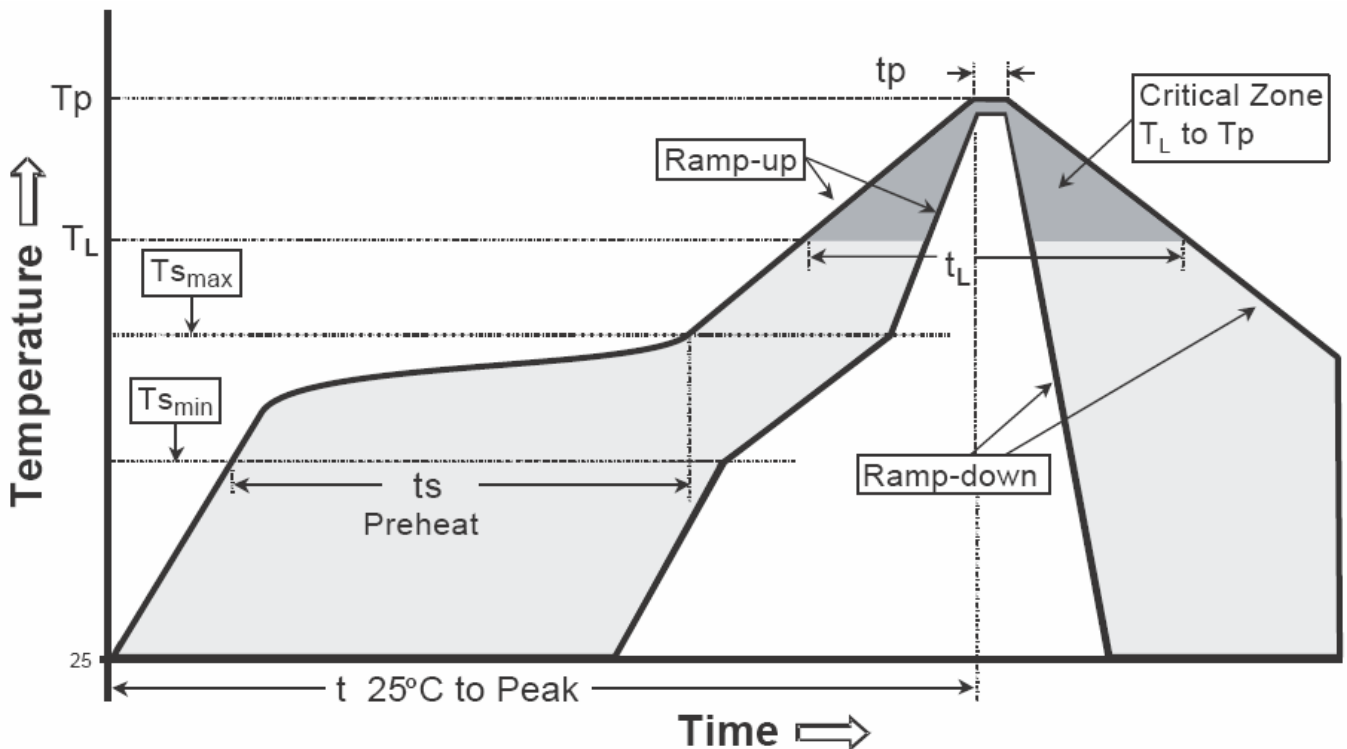
Recommended temperature profile for IR reflow

Profile feature	Sn-Pb eutectic Assembly	Pb-free Assembly
Average ramp-up rate (T _{smax} to T _p)	3°C/second max.	3°C/second max.
Preheat		
-Temperature Min(T _{s min})	100°C	150°C
-Temperature Max(T _{s max})	150°C	200°C
-Time(t _{s min} to t _{s max})	60-120 seconds	60-180 seconds
Time maintained above:		
-Temperature (T _L)	183°C	217°C
- Time (t _L)	60-150 seconds	60-150 seconds
Peak Temperature(T _P)	240 +0/-5 °C	260 +0/-5 °C
Time within 5°C of actual peak temperature(t _p)	10-30 seconds	20-40 seconds
Ramp down rate	6°C/second max.	6°C/second max.
Time 25 °C to peak temperature	6 minutes max.	8 minutes max.

Note : All temperatures refer to topside of the package, measured on the package body surface.

SOT-23 Dimension

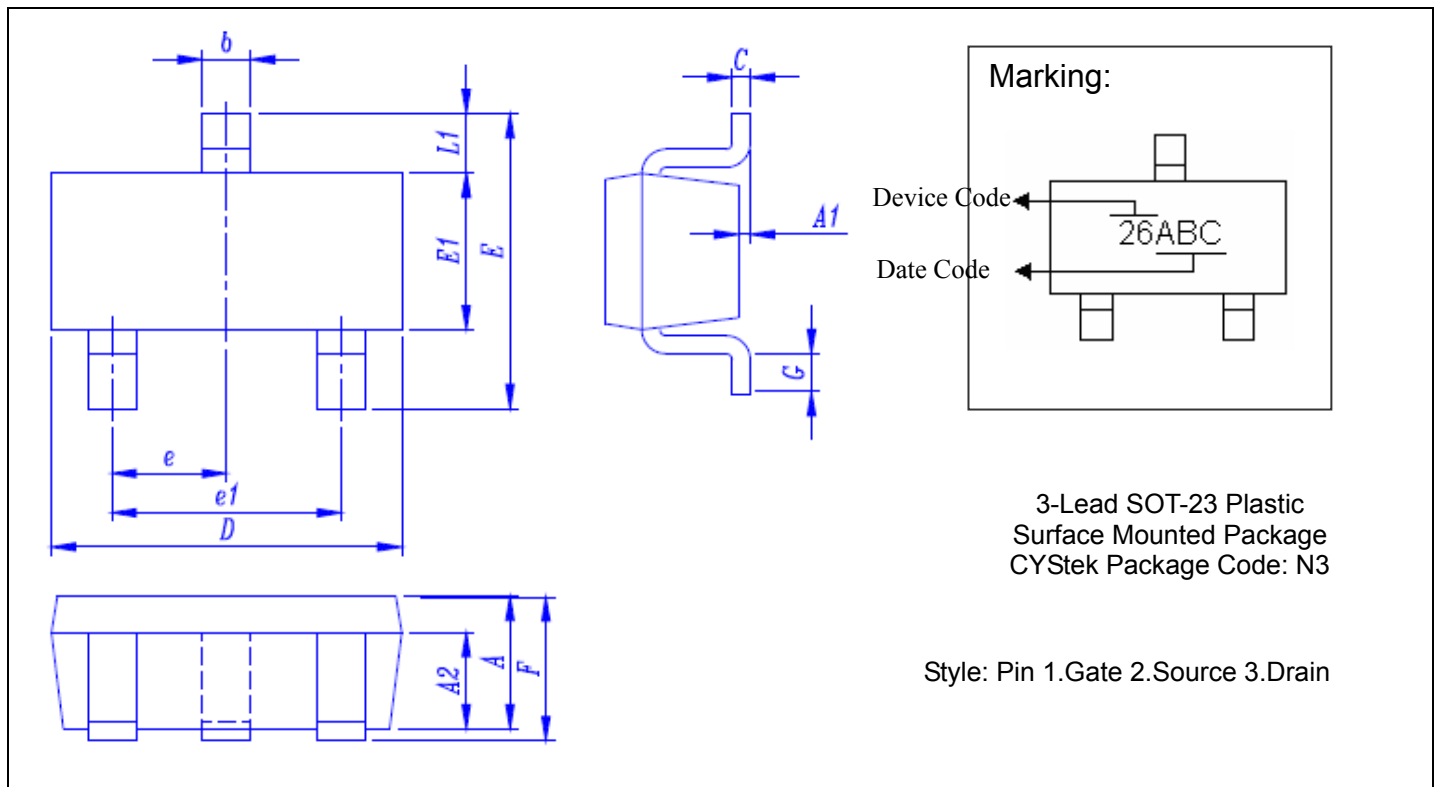

*: Typical

DIM	Inches		Millimeters		DIM	Inches		Millimeters	
	Min.	Max.	Min.	Max.		Min.	Max.	Min.	Max.
A	0.0335	0.0492	0.85	1.25	E1	0.0532	0.0709	1.35	1.80
A1	0.0000	0.0051	0.00	0.13	e	0.0374*		0.95*	
A2	0.0315*		0.80*		e1	0.0748*		1.90*	
b	0.0118	0.0197	0.30	0.50	F	0.0335	0.0543	0.85	1.38
C	0.0032	0.0079	0.08	0.20	G	0.0079	0.0236	0.20	0.60
D	0.1083	0.1220	2.75	3.10	L1	0.0138	0.0295	0.35	0.75
E	0.0906	0.1063	2.30	2.70					

Notes: 1.Controlling dimension: millimeters.
 2.Maximum lead thickness includes lead finish thickness, and minimum lead thickness is the minimum thickness of base material.
 3.If there is any question with packing specification or packing method, please contact your local CYStek sales office.

Material:

- Lead: Pure tin plated.
- Mold Compound: Epoxy resin family, flammability solid burning class: UL94V-0.

Important Notice:

- All rights are reserved. Reproduction in whole or in part is prohibited without the prior written approval of CYStek.
- CYStek reserves the right to make changes to its products without notice.
- CYStek **semiconductor products are not warranted to be suitable for use in Life-Support Applications, or systems.**
- CYStek assumes no liability for any consequence of customer product design, infringement of patents, or application assistance.