

76mm**San Ace B76**20mm thick
30mm thick**General Specifications**

- Material Frame: Plastics (Flammability: UL94V-0),
Impeller: Plastics (Flammability: UL94V-0)
- Expected Life Refer to specifications (L10:Survival rate: 90% at 60°C ,
rated voltage, and continuously run in a free air state)
- Lead Wire ⊕red ⊖black (Sensor) yellow
- Storage Temperature -30°C to +70°C (Non-condensing)

76mm×20mm (Mass : 58g)**Specifications** The following nos. **have pulse sensors.**

Model No.	Rated Voltage [V]	Operating Voltage Range [V]	Rated Current [A]	Rated Input [W]	Rated Speed [min ⁻¹]	Max. Air Flow [m ³ /min] [CFM]	Max. Static Pressure [Pa] [inchH ₂ O]	SPL [dB(A)]	Operating Temperature [°C]	Expected Life ⁽¹⁾ [h]
9BD12SC6-1	12	5 to 13.8	0.28	3.36	4,500	0.29 10.2	300 1.20	43	-20 to +70	40,000/60°C (70,000/40°C)
9BD12HC6-1			0.21	2.52	4,200	0.27 9.5	230 0.92	41		
9BD12FC6-1		5.5 to 13.8	0.18	2.16	3,900	0.25 8.8	200 0.80	39		
9BD24SC6-1	24	10 to 27.6	0.14	3.36	4,500	0.29 10.2	300 1.20	43		
9BD24HC6-1			0.12	2.88	4,200	0.27 9.5	230 0.92	41		
9BD24FC6-1			0.10	2.4	3,900	0.25 8.8	200 0.80	39		

Note: Expected life at 40°C ambient is just reference value.

- Available options: ⇒ **Without Sensor**

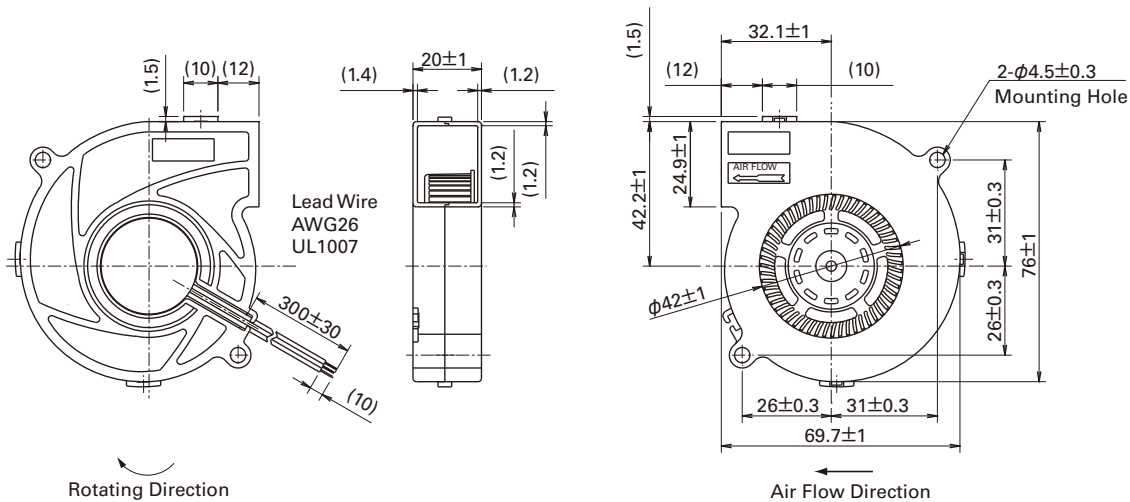
Dimensions (Unit : mm)

Air Flow - Static Pressure Characteristics

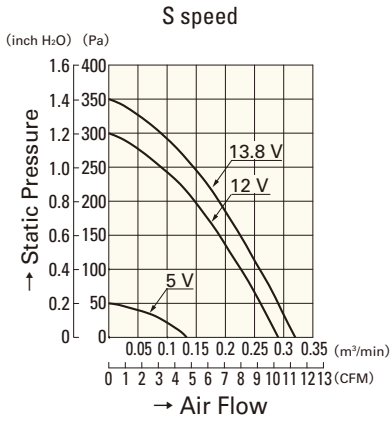

9BD12SC6-1

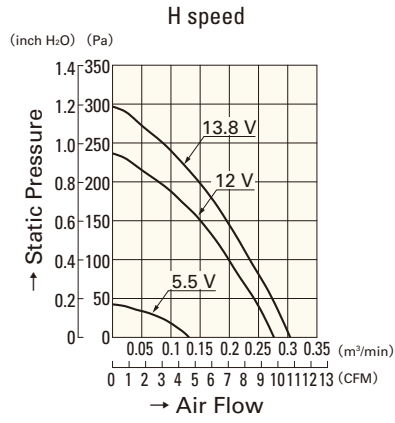

9BD12HC6-1

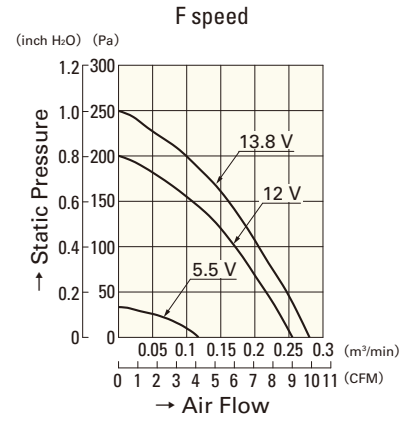

9BD12FC6-1

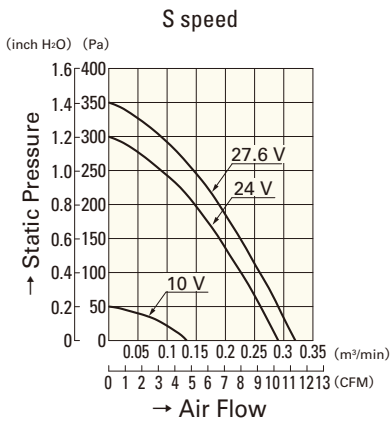

9BD24SC6-1

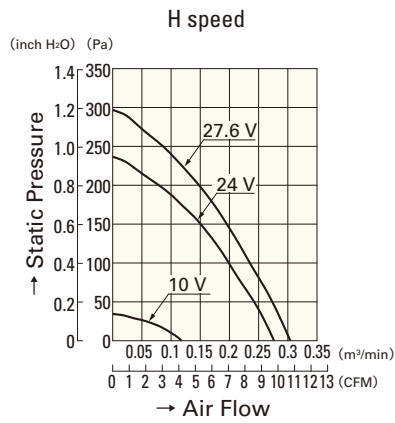

9BD24HC6-1

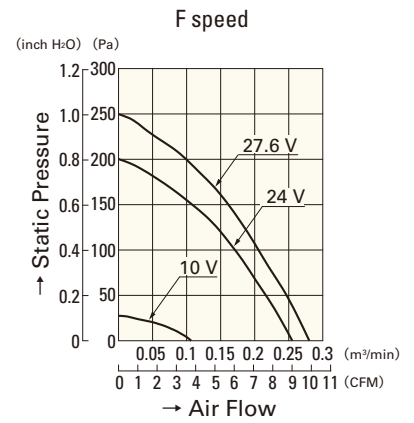

9BD24FC6-1

Blower 76mm