

## Applications

- Power amplifier application
- High current switching application

## Features

- Low saturation voltage  
:  $V_{CE(sat)} = -0.15V$  Typ. @  $I_C = -1A$ ,  $I_B = -50mA$
- Large collector current capacity:  $I_C = -3A$
- TO-220F-3L DIP type package

## Ordering Information

Type NO.	Marking	Package Code
STA3350PI	STA3350	TO-220F-3L

## PIN Connection

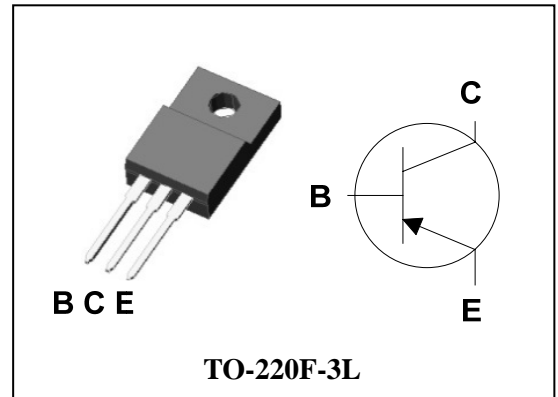

## Absolute Maximum Ratings

[Ta=25°C]

Characteristic	Symbol	Rating	Unit
Collector-base voltage	$V_{CBO}$	-50	V
Collector-emitter voltage	$V_{CEO}$	-50	V
Emitter-base voltage	$V_{EBO}$	-6	V
Collector current	$I_C$	-3	A(DC)
	$I_{CP}^*$	-6	A(Pulse)
Collector Power dissipation( $T_C = 25^\circ C$ )	$P_C$	10	W
Junction temperature	$T_J$	150	°C
Storage temperature range	$T_{stg}$	-55 ~ 150	°C

 \* : Single pulse,  $t_p = 300 \mu s$ 

## Electrical Characteristics

[Ta=25°C]

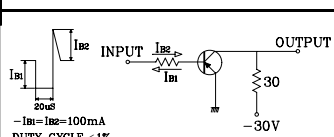
Characteristic	Symbol	Test Condition	Min.	Typ.	Max.	Unit	
Collector-emitter breakdown voltage	$BV_{CEO}$	$I_C = -1mA$ , $I_B = 0$	-50	-	-	V	
Collector cut-off current	$I_{CBO}$	$V_{CB} = -50V$ , $I_E = 0$	-	-	-1	$\mu A$	
Emitter cut-off current	$I_{EBO}$	$V_{EB} = -6V$ , $I_C = 0$	-	-	-1	$\mu A$	
DC current gain	$h_{FE}$	$V_{CE} = -2V$ , $I_C = -0.5A^*$	120	-	240		
	$h_{FE}$	$V_{CE} = -2V$ , $I_C = -2A^*$	40	-	-		
Collector-emitter saturation voltage	$V_{CE(sat)}$	$I_C = -1A$ , $I_B = -0.05A^*$	-	-	-0.35	V	
Base-emitter saturation voltage	$V_{BE(sat)}$	$I_C = -2A$ , $I_B = -0.1A^*$	-	-0.97	-1.2	V	
Transition frequency	$f_T$	$V_{CE} = -10V$ , $I_C = -0.05A$	-	250	-	MHz	
Collector output capacitance	$C_{ob}$	$V_{CB} = -10V$ , $I_E = 0$ , $f = 1MHz$	-	28	-	pF	
Switching Time	Turn-on Time	$t_{on}$		-	100	-	ns
	Storage Time	$t_{stg}$		-	300	-	
	Fall Time	$t_f$		-	50	-	

 \* : Pulse test :  $t_p \leq 300 \mu s$ , Duty cycle  $\leq 2\%$

Electrical Characteristic Curves

Fig. 1  $P_C - T_a$

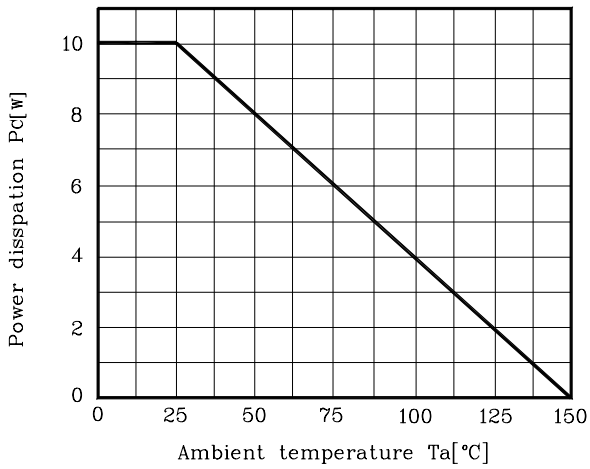

Fig. 2  $I_C - V_{BE}$

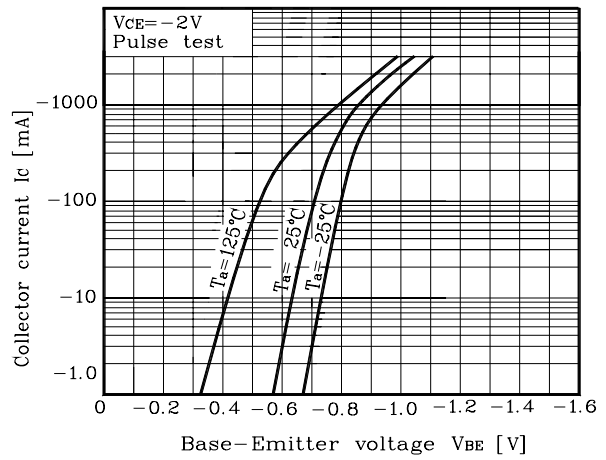

Fig. 3  $I_C - V_{CE}$

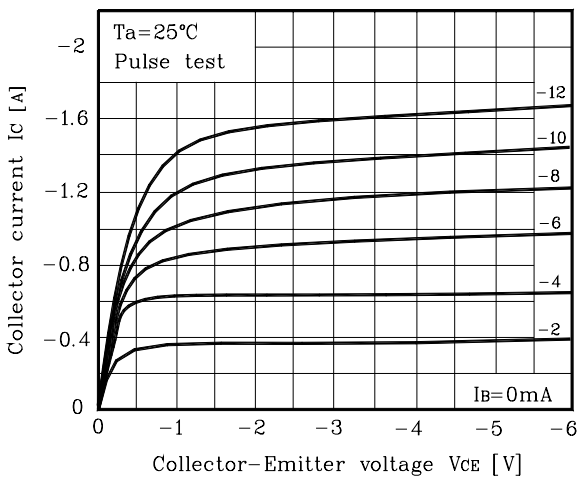

Fig. 4  $h_{FE} - I_C$

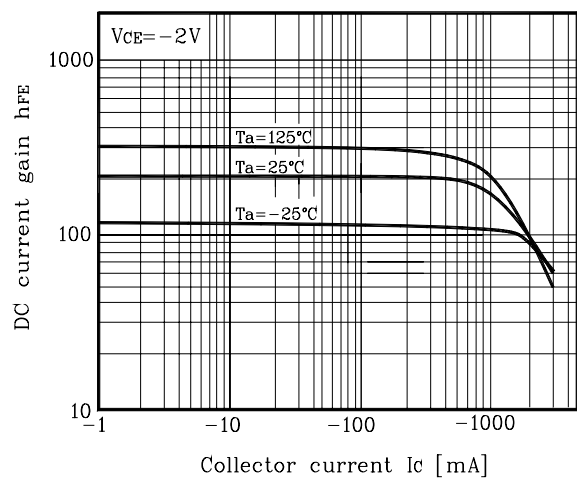

Fig. 5  $V_{CE(sat)} - I_C$

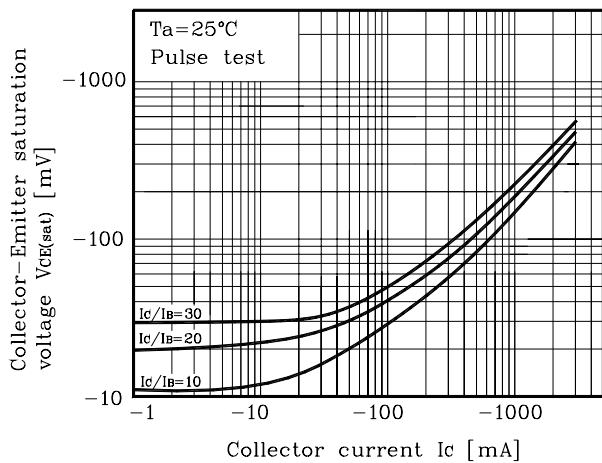
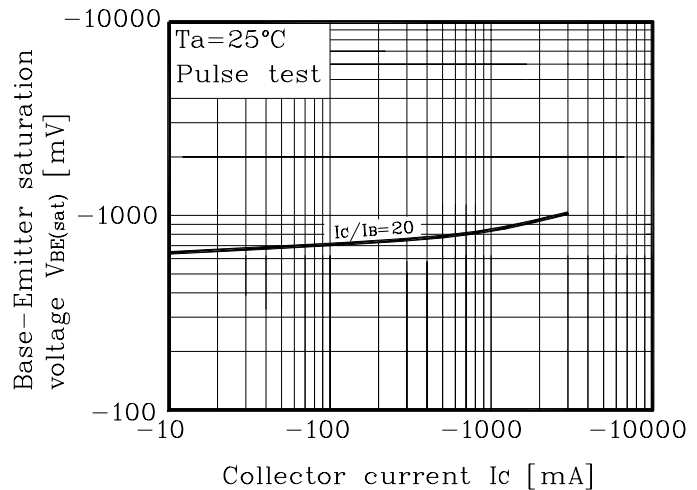

Fig. 6  $V_{BE(sat)} - I_C$



Electrical Characteristic Curves

Fig. 7  $C_{ob} - V_{CB}$

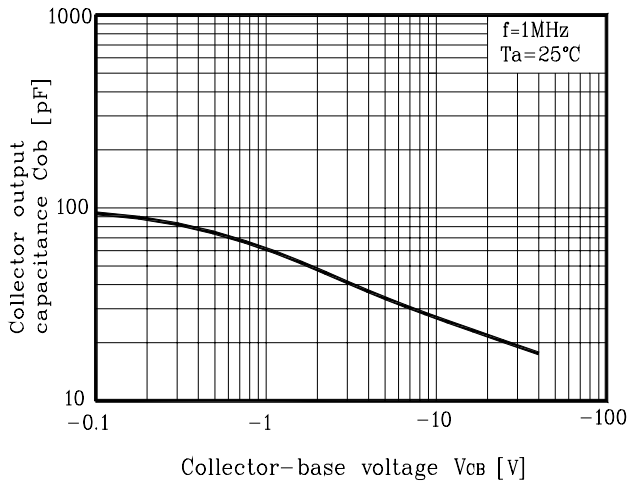
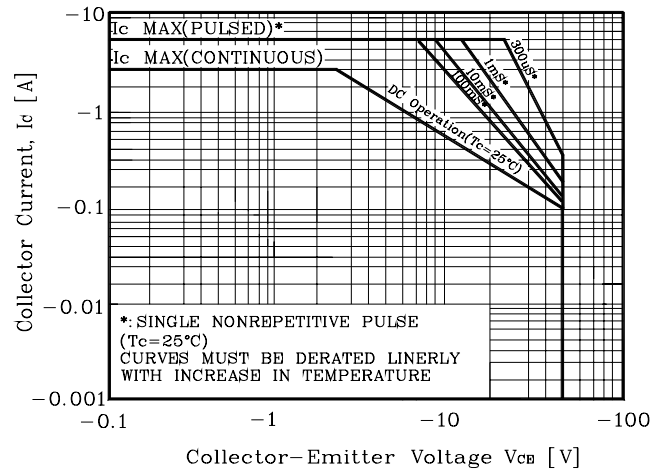
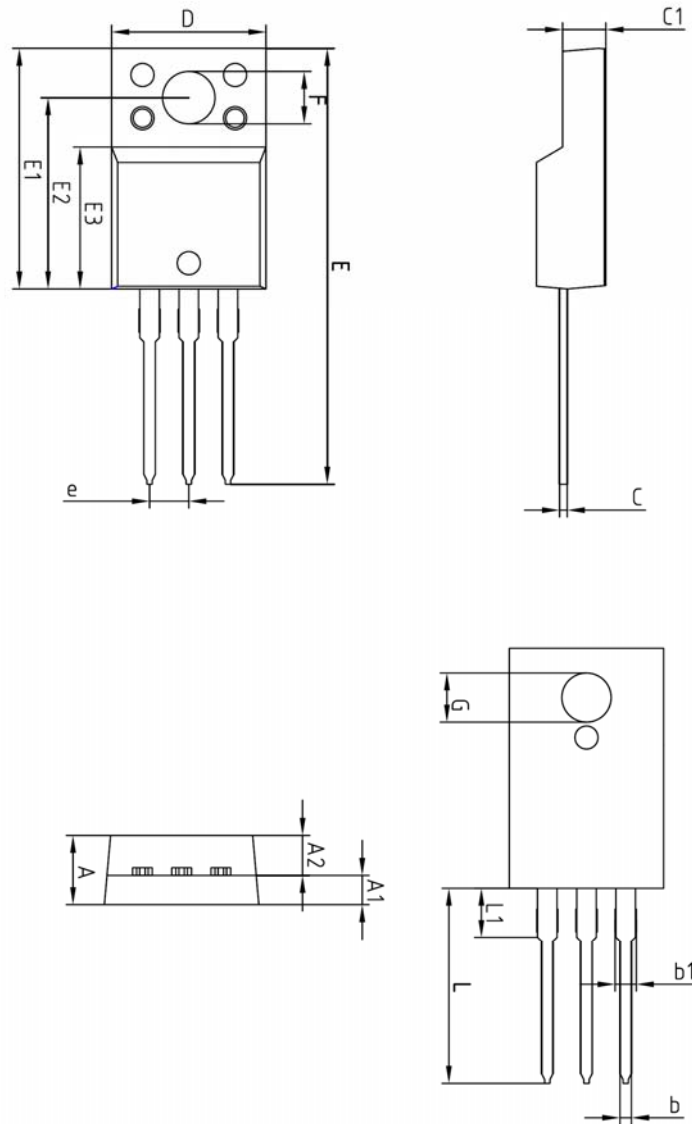

Fig. 8 Safe Operating Area



## Outline Dimension



SYMBOL	MILLIMETERS			NOTE
	MINIMUM	NOMINAL	MAXIMUM	
A	-	-	4.60	
A1	2.45	2.50	2.55	
A2	1.95	2.00	2.05	
b	0.65	0.75	0.85	
b1	1.07	1.27	1.47	
C	0.40	0.50	0.60	
C1	2.70	2.80	2.90	
D	9.90	10.00	10.10	
E	28.00	-	28.60	
E1	15.50	15.60	15.70	
E2	12.30	12.40	12.50	
E3	9.15	9.20	9.25	
F	3.30	3.40	3.50	
G	3.10	3.20	3.30	
e	2.54 BSC			
L	12.40	-	13.00	
L1	3.46 BSC			

**The AUK Corp. products are intended for the use as components in general electronic equipment (Office and communication equipment, measuring equipment, home appliance, etc.).**

**Please make sure that you consult with us before you use these AUK Corp. products in equipments which require high quality and / or reliability, and in equipments which could have major impact to the welfare of human life(atomic energy control, airplane, spaceship, transportation, combustion control, all types of safety device, etc.). AUK Corp. cannot accept liability to any damage which may occur in case these AUK Corp. products were used in the mentioned equipments without prior consultation with AUK Corp..**

**Specifications mentioned in this publication are subject to change without notice.**