

HYBRID-HIGH RELIABILITY RADIATION HARDENED DC-DC CONVERTER

M3G-SERIES 28V Input, Triple Output



Description

The M3G-Series of DC-DC converters are radiation hardened, high reliability converters designed for extended operation in hostile environments. Their small size and low weight make them ideal for applications such as geostationary earth orbit satellites and deep space probes. They exhibit a high tolerance to total ionizing dose, single event effects and environmental stresses such as temperature extremes, mechanical shock, and vibration.

The converters incorporate a fixed frequency single ended forward topology with magnetic feedback and an internal EMI filter that utilizes multilayer ceramic capacitors that are subjected to extensive lot screening for optimum reliability. These converters are capable of meeting the conducted emissions and conducted susceptibility requirements of MIL-STD-461C without any additional components. External inhibit and synchronization input and output allow these converters to be easily incorporated into larger power systems. They are enclosed in a hermetic 3" x 2" x 0.475" package constructed of an Aluminum-Silicon-Carbide (AlSiC) base and an Alloy 48 ring frame and they weigh less than 110 grams. The package utilizes rugged ceramic feed-through copper core pins and is sealed using parallel seam welding.

Manufactured in a facility fully qualified to MIL-PRF-38534, these converters are fabricated utilizing DLA Land and Maritime qualified processes. For available screening options, refer to device screening table in the data sheet.

Non-flight versions of the M3G-Series converters are available for system development purposes. Variations in electrical specifications and screening to meet custom requirements can be accommodated.

Features

- Total Dose > 200 krad(Si), typically usable to > 300 krad(Si)
- SEE Hardened up to 82 MeV·cm²/mg
- Internal EMI filter; Converter Capable of meeting MIL-STD-461C CE03
- Low Weight, < 110 grams
- Magnetically Coupled Feedback
- 18V to 50V DC Input Range
- Up to 40W Output Power
- Triple Output Models Include +5V and ±12V or ±15V
- Main Output Isolated from Dual Outputs
- High Efficiency - to 80%
- -55°C to +125°C Operating Temperature Range
- 100MΩ @ 500VDC Isolation
- Under-Voltage Lockout
- Synchronization Input and Output
- Short Circuit and Overload Protection
- Output Over Voltage Limiter
- External Inhibit
- > 5,000,000 Hour MTBF
- Standard Microcircuit Drawings Available

Applications

- Geostationary Earth Orbit Satellites (GEO)
- Deep Space Satellites / Probes
- Strategic Weapons and Communication Systems

M3G-SERIES (28V Input, Triple Output)

International
IR Rectifier

Circuit Description

The M3G-Series converters utilize a single-ended forward topology with resonant reset. The nominal switching frequency is 500kHz. Electrical isolation and tight output regulation are achieved through the use of a magnetically coupled feedback. Voltage feed-forward with duty factor limiting provides high line rejection and protection against output over voltage in the event of an internal control loop failure. This mechanism limits the maximum output voltage to approximately 20% over the nominal regardless of the line voltage.

An internal EMI filter allows the converter to meet the conducted emissions requirements of MIL-STD-461C on the input power leads. A two-stage output filter reduces the typical output ripple to less than 20mV peak-to-peak.

The main (+5 volt) output is regulated by the control loop and typically exhibits better than 1% regulation. The auxiliary (± 12 volt or ± 15 volt) outputs are maintained through tight coupling in the power transformer and main output filter inductor and typically exhibit better than 5% regulation. The main output and auxiliary outputs are isolated from each other.

Output power is limited under any load fault condition to approximately 125% of rated. An overload condition causes the converter output to behave like a constant current source with the output voltage dropping below nominal. The converter will resume normal operation when the load current is reduced below the current limit point. This protects the converter from both overload and short circuit conditions. The current limit point exhibits a slightly negative temperature coefficient to reduce the possibility of thermal runaway.

An under-voltage lockout circuit prohibits the converter from operating when the line voltage is too low to maintain the output voltage. The converter will not start until the line voltage rises to approximately 16.5 volts and will shut down when the input voltage drops below 15.5 volts. The one volt of hysteresis reduces the possibility of line noise interfering with the converter's start-up and shut down.

An external inhibit port is provided to control converter operation. The nominal threshold relative to the input return (pin 2) is 1.4V. If 2.0 volts or greater are applied to the Inhibit pin (pin 3) then the converter will operate normally. A voltage of 0.8V or less will cause the converter to shut-down. The pin may be left open for normal operation and has a nominal open circuit voltage of 4.0V.

Synchronization input and output allow multiple converters to operate at a common switching frequency. Converters can be synchronized to one another or to an externally provided clock. This can be used to eliminate beat frequency noise or to avoid creating noise at certain frequencies for sensitive systems.

Design Methodology

The M3G-Series was developed using a proven conservative design methodology which includes selecting radiation tolerant and established reliability components and fully derating to the requirements of MIL-STD-975 and MIL-STD-1547 except for the CDR type ceramic capacitors, a capacitor with 50V rating is used for in-circuit voltage stress of less than 10V. Careful sizing of decoupling capacitors and current limiting resistors minimizes the possibility of photo-current burn-out. Heavy derating of the radiation hardened power MOSFET virtually eliminates the possibility of SEGR and SEB. A magnetic feedback circuit is utilized instead of opto-couplers to minimize temperature, radiation and aging sensitivity. PSpice and RadSpice were used extensively to predict and optimize circuit performance for both beginning and end-of-life. Thorough design analyses include Radiation Susceptibility (TREE), Worst Case, Stress, Thermal, Failure Modes and Effects (FMEA) and Reliability (MTBF).

Specifications

| Absolute Maximum Ratings | | Recommended Operating Conditions | |
|--------------------------|-----------------------|------------------------------------|------------------|
| Input voltage range | -0.5Vdc to +80Vdc | Input voltage range | +18Vdc to +60Vdc |
| Output power | Internally limited | Input voltage range ¹ | +18Vdc to +50Vdc |
| Lead temperature | +300°C for 10 seconds | Output power | 0 to Max. Rated |
| Operating temperature | -55°C to +135°C | Operating temperature ² | -55°C to +125°C |
| Storage temperature | -55°C to +135°C | Operating temperature ¹ | -55°C to +70°C |

¹ Meets derating per MIL-STD-975

² For operation at +125°C see table note 14

Electrical Performance Characteristics

| Parameter | Group A Subgroup | Conditions -55°C ≤ T _c ≤ +85°C V _{IN} = 28V DC ± 5%, C _L = 0 unless otherwise specified | Limits | | | Unit |
|---|------------------|---|--------------------------|--------------------------|--------------------------|------|
| | | | Min | Nom | Max | |
| Input Voltage | 1,2,3 | Note 2 | 18 | 28 | 50 | V |
| Output Voltage (V _{OUT}) (main) M3G280512T (aux.) M3G280515T (aux.) | 1 | I _{OUT} = 100% rated load, Note 5 | 4.98 ±11.50 ±14.60 | 5.00 ±11.80 ±14.90 | 5.02 ±12.10 ±15.20 | V |
| (main) M3G280512T (aux.) M3G280515T (aux.) | 2,3 | | 4.93 ±11.30 ±14.40 | | 5.07 ±12.30 ±15.40 | |
| Output power (P _{OUT}) | 1,2,3 | V _{IN} = 18, 28, 50 Volts, Note 2 | 0 | | 40 | W |
| Output current (I _{OUT}) (main) M3G280512T (aux.) M3G280515T (aux.) | 1,2,3 | V _{IN} = 18, 28, 50 Volts, Notes 2,3,4,5 | 400 83 67 | | 4000 ±833 ±667 | mA |
| Line regulation (V _{R,LINE}) (main) M3G280512T (aux.) M3G280515T (aux.) | 1,2,3 | V _{IN} = 18, 28, 50 Volts I _{OUT} = 10, 50%, 100% rated Note 5 | -10 -120 -150 | | 10 120 150 | mV |
| Load regulation (V _{R,LOAD}) (main) M3G280512T (aux.) M3G280515T (aux.) | 1,2,3 | I _{OUT} = 10%, 50%, 100% rated V _{IN} = 18, 28, 50 Volts Notes 5,13 | -50 -400 -500 | | 50 400 500 | mV |
| Cross regulation (V _{R,CROSS}) (main) M3G280512T (aux.) M3G280515T (aux.) | 1,2,3 | V _{IN} = 18, 28, 50 Volts I _{OUT} = 2.5A to 1A and 2.5 to 4A on main and ±half rated on aux. outputs | -3.5 -3.0 | | 3.5 3.0 | % |
| Input current (I _{IN}) | 1,2,3 | I _{OUT} = 0, Pin 3 open | | | 80 | mA |
| | | Pin 3 shorted to pin 2 | | | 5.0 | |

For Notes to Specifications, refer to page 5

Electrical Performance Characteristics (continued)

| Parameter | Group A Subgroup | Conditions -55°C ≤ T _C ≤ +85°C V _{IN} = 28V DC ± 5%, C _L = 0 unless otherwise specified | Limits | | | Unit |
|--|------------------|---|--------------------------------|----------------|--------------------------|----------------------------|
| | | | Min | Nom | Max | |
| Output ripple (V _{RIP}) (main) M3G280512T (aux.) M3G280515T (aux.) | 1,2,3 | V _{IN} = 18, 28, 50 Volts I _{OUT} = 100% rated load, Notes 5, 6 | | 25 30 30 | 50 60 75 | mV p-p |
| Switching frequency (F _S) | 1,2,3 | Sync. Input (Pin 4) open | 450 | 500 | 550 | KHz |
| Efficiency (E _{FF}) | 1,2,3 | I _{OUT} = 100% rated load Note 5 | 75 | 79 | | % |
| Inhibit Input open circuit voltage drive current (sink) voltage range | | Note 1 | 3.0 -0.5 | | 5.0 100 50 | V μA V |
| Synchronization Input frequency range pulse high level pulse low level pulse transition time pulse duty cycle | | Ext. Clock on Sync. Input (Pin 4) Note 1 | 450 4.0 -0.5 40 20 | | 600 10.0 0.5 80 | KHz V V V/μs % |
| Current Limit Point Expressed as a percentage of full rated output power | 1,2 3 | V _{out} = 90% of Nominal, Note 5 | | | 135 150 | % |
| Power dissipation, load fault (P _D) | 1,2,3 | Short Circuit, Overload, Note 8 | | | 20 | W |
| Output response to step load changes (V _{TLD}) | 4,5,6 | Half Load to/from Full Load, Notes 5,9 | -300 | | 300 | mV pk |
| Recovery time, step load changes (T _{TLD}) | 4,5,6 | Half Load to/from Full Load, Note 5,9,10 | | | 200 | μs |
| Output response to step line changes (V _{TLN}) | | 18V to/from 50V I _{OUT} = 100% rated load, Notes 1,5,11 | -300 | | 300 | mV pk |
| Recovery time, step line changes (T _{TLN}) | | 18V to/from 50V I _{OUT} = 100% rated load, Notes 1,5,10,11 | | | 200 | μs |
| Turn-on Response Overshoot (V _{OS}) (main) (aux.) Turn-on Delay (T _{DLY}) | 4,5,6 | No Load, Full Load, Notes 5,12 10% of Nominal | | | 500 10 5.0 | mV % ms |
| Capacitive Load (CL) (main) (Each aux. output) | | I _{OUT} = 100% rated load, No effect on DC performance, Notes 1, 5, 7 | | | 1000 200 | μF |

For Notes to Specifications, refer to page 5

Electrical Performance Characteristics (continued)

| Parameter | Group A Subgroup | Conditions -55°C ≤ T _C ≤ +85°C V _{IN} = 28V DC ± 5%, C _L = 0 unless otherwise specified | Limits | | | Unit |
|----------------|------------------|---|---------------------|-----|-----|------|
| | | | Min | Nom | Max | |
| Line Rejection | | I _{OUT} = 100% rated load DC to 50KHz, Notes 1,5 | 40 | 60 | | dB |
| Isolation | 1 | Input to Output or any pin to case Except pin 10, test @500VDC | 100 | | | MΩ |
| Device Weight | | | | | 110 | g |
| MTBF | | MIL-HDBK-217F2, SF, 35°C | 5 x 10 ⁶ | | | Hrs |

Notes: Electrical Performance Characteristics

1. Parameter is tested as part of design characterization or after design changes. Thereafter, parameter shall be guaranteed to the limits specified.
2. Parameter verified during line and load regulation tests.
3. Although operation with no load is permissible, light loading on the main (+5 volt) output may cause the output voltage of the auxiliary outputs (±12 volt or ±15 volt) to drop out of regulation. It is therefore recommended that at least 200 mA or 20 percent of the total output power, whichever is greater, be taken from the main (+5 volt) output.
4. Although operation with no load is permissible, heavy loading on the main (+5 volt) output may cause the output voltage of the auxiliary outputs (±12 volt or ±15 volt) to rise out of regulation. It is therefore recommended that at least 50 mA or 20 percent of the total output power, whichever is greater, be taken from the auxiliary (±12 volt or ±15 volt) outputs.
5. Unless otherwise specified, "Rated" load is 20W on the main (+5 volt) output and 10 watts each on the auxiliary (±12 volt or ±15 volt) outputs. Load currents of up to 5A and ±1A on the main and auxiliary outputs respectively are acceptable as long as the total output power does not to exceed 40 watts.
6. Guaranteed for a D.C. to 20MHz bandwidth. Tested using a 20KHz to 10MHz bandwidth.
7. Capacitive load may be any value from 0 to the maximum limit without compromising dc performance. A capacitive load in excess of the maximum limit may interfere with the proper operation of the converter's overload protection, causing erratic behavior during turn-on.
8. Overload power dissipation is defined as the device power dissipation with the load set such that V_{OUT} = 90% of nominal.
9. Load step transition time ≥ 10 μs.
10. Recovery time is measured from the initiation of the transient to where V_{OUT} has returned to within ±1% of its steady state value.
11. Line step transition time ≥ 100 μs.
12. Turn-on delay time from either a step application of input power or a logic low to a logic high transition on the inhibit pin (pin 3) to the point where V_{OUT} = 90% of nominal.
13. Load is varied for output under test while the remaining outputs are loaded at 50% of rated. Regulation relative to output voltage at 50% rated load.
14. Although operation at temperatures between +85°C and +125°C is guaranteed, no parametric limits are specified.

Radiation Performance Characteristics

| Test Inspection | Method | Min | Typ | Unit |
|---|---|-------------|------|--------------------------|
| Total Ionizing Dose (Gamma) | MIL-PRF-883, Method 1019 Operating bias applied during exposure, Full Rated Load, $V_{IN} = 28V$ | 200 | 300 | Krads(Si) |
| Dose Rate (Gamma Dot) Temporary Saturation Survival | MIL-STD-883, Method 1023 Operating bias applied during exposure, Full Rated Load, $V_{IN} = 28V$ | 1E8 4E10 | 1E11 | Rads(Si)/sec |
| Neutron Fluence | MIL-STD-883, Method 1017 | 8E12 | 1E13 | Neutrons/cm ² |
| Single Event Effects SEU, SEL, SEGR, SEB | Heavy Ions (LET) Operating bias applied during exposure, Full Rated Load, $V_{IN} = 28V$ Test lab: Brookhaven National Laboratory, Tandem Van de Graaff Generator | 82 | | MeV·cm ² /mg |

International Rectifier currently does not have a DLA Land and Maritime certified Radiation Hardness Assurance Program.

Figure 1. Block Diagram - Triple Output

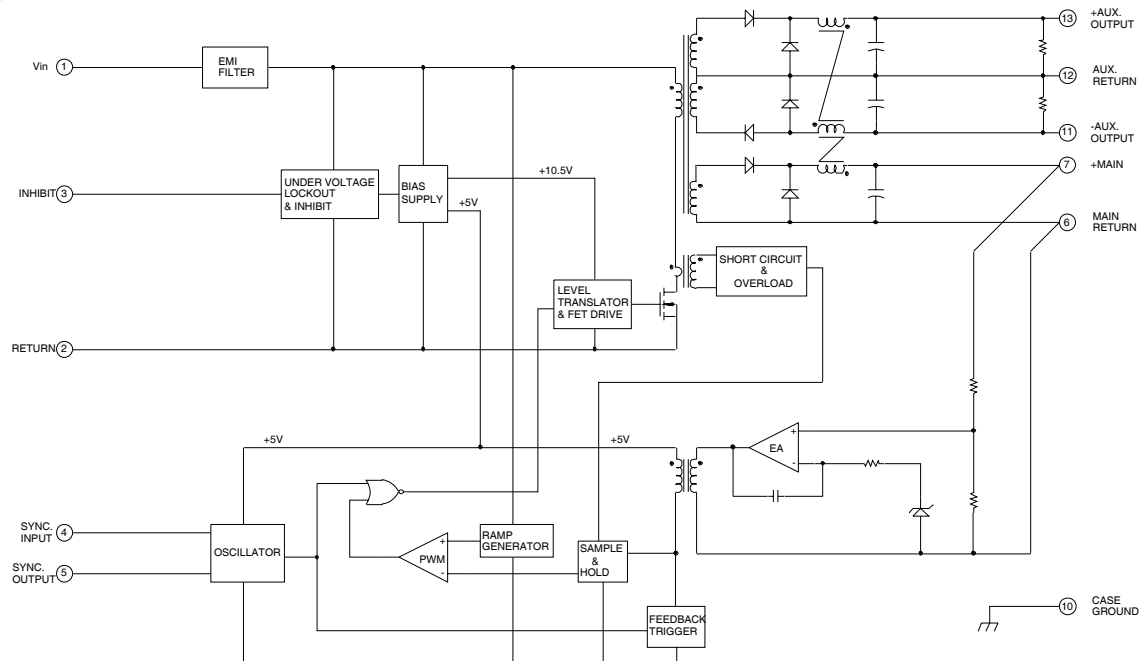

Figure 2. $\pm 12V$ Load Regulation vs 5V Load

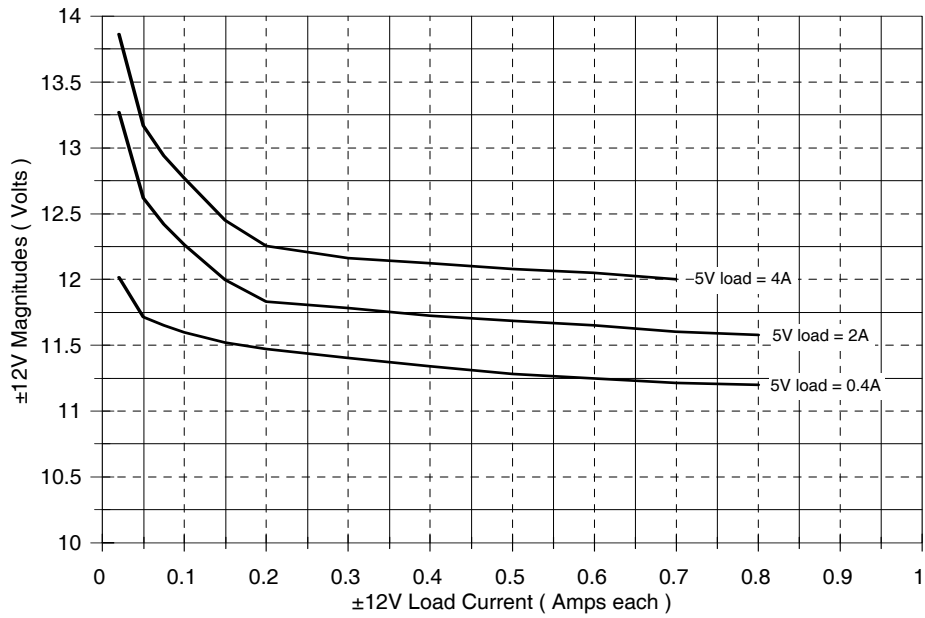

Figure 3. $\pm 15V$ Load Regulation vs 5V Load

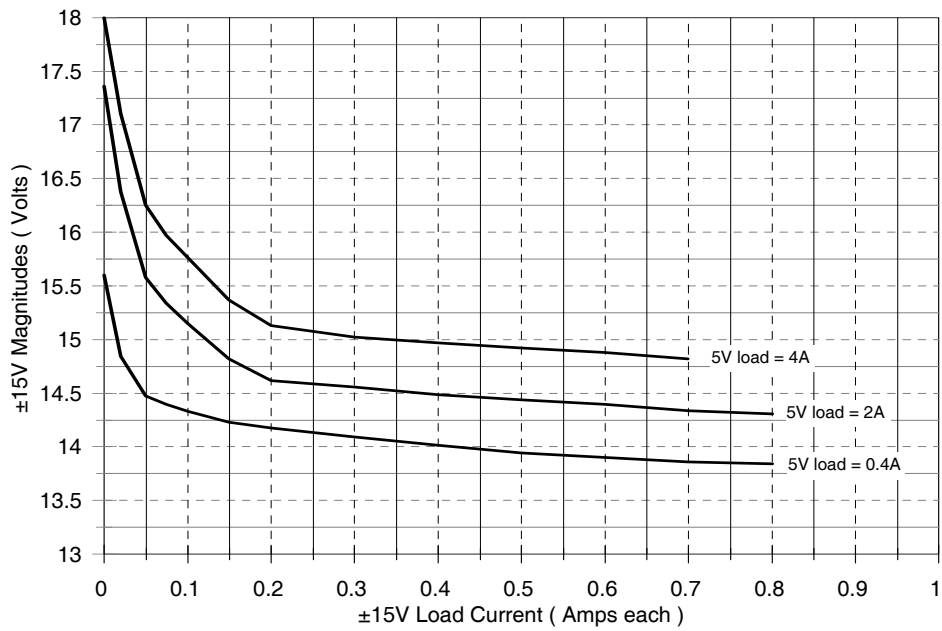

Figure 4. M3G280512T Efficiency vs Line and Load

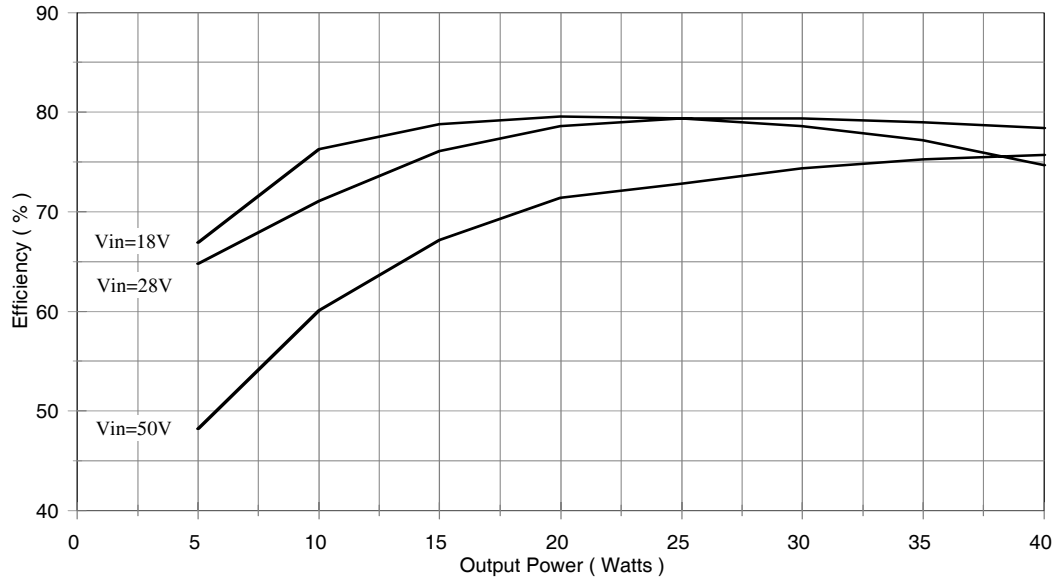

Figure 5. M3G280515T Efficiency vs Line and Load

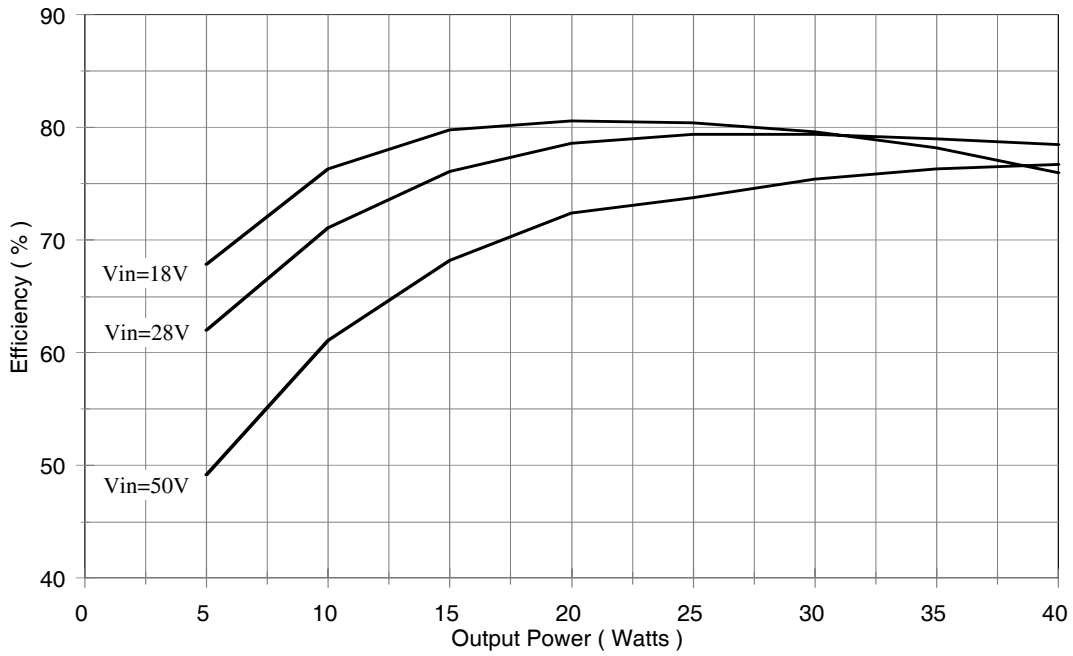

Figure 6. Conducted Emissions, Positive Lead

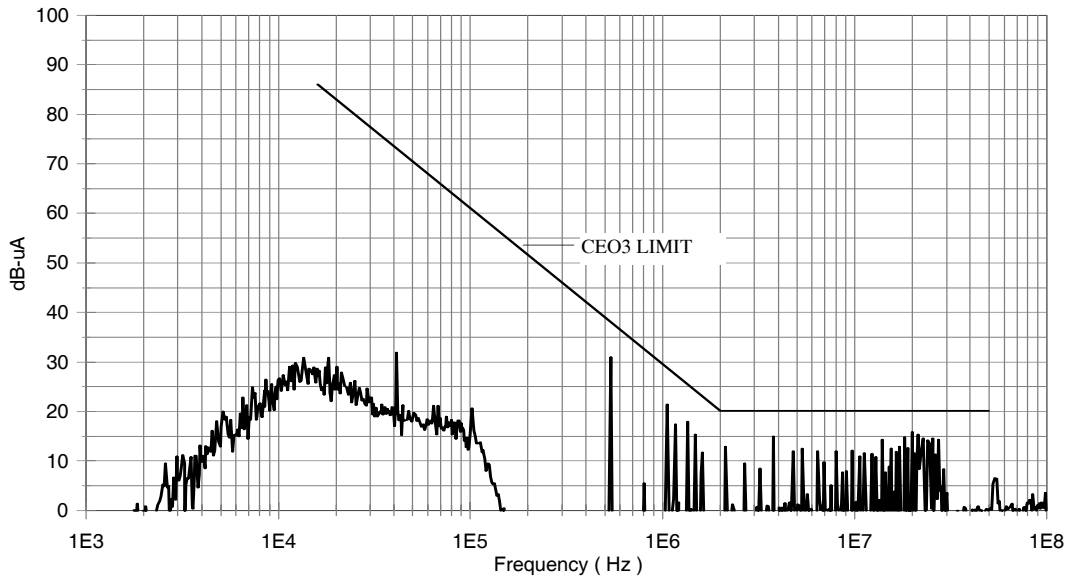

Figure 7. Conducted Emissions, Return Lead

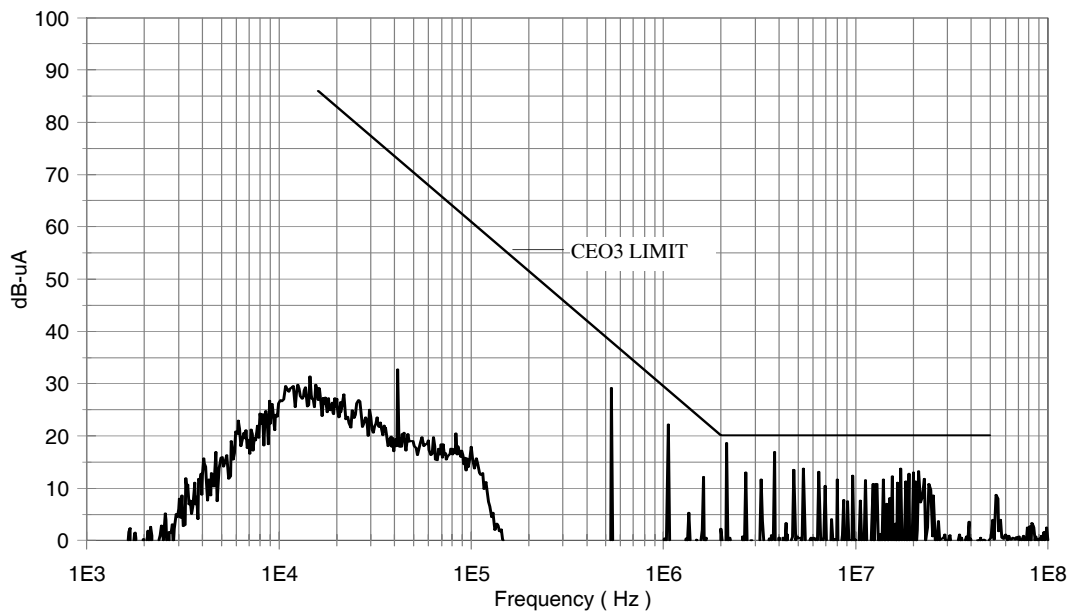
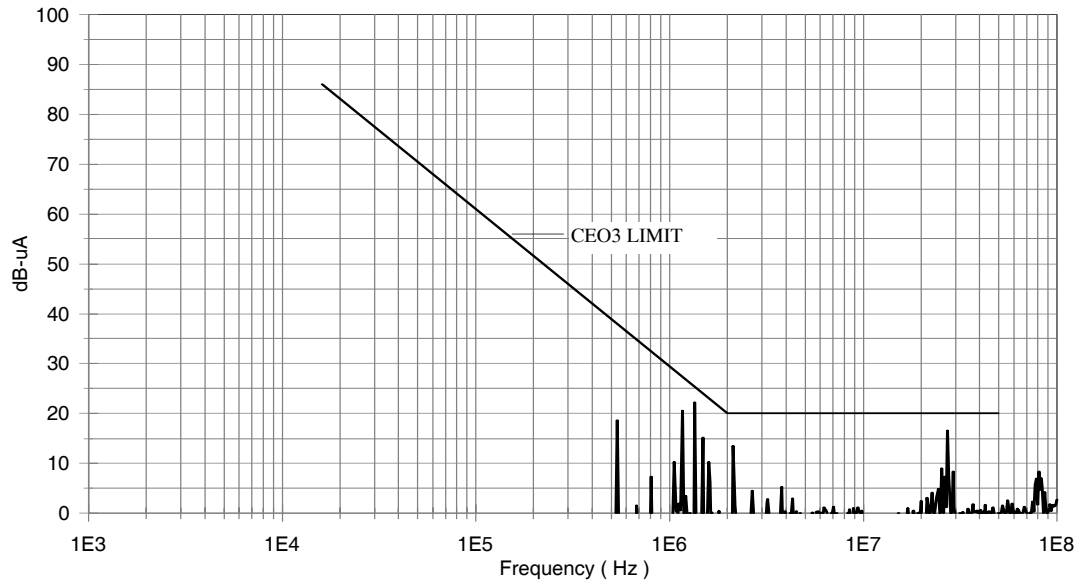

Figure 8. Conducted Emissions, Common Mode



Application Note:

A) Attachment of the Converter

The following procedure is recommended for mounting the converter for optimum cooling and to circumvent any potential damage to the converter.

Ensure that flatness of the plate where M3G converter to be mounted is no greater than 0.003" per linear inch. It is recommended that a thermally conductive gasket is used to promote the thermal transfer and to fill any voids existing between the two surfaces. IR recommends Sil-Pad 2000 with the thickness of 0.010". The shape of the gasket should match the footprint of the converter including the mounting flanges. The gasket is available from IR. The M3G-series converter requires either M3 or 4-40 size screws for attachment purposes.

The procedure for mounting the converter is as follows:

1. Check the mounting surfaces and remove foreign material, burrs if any or anything that may interfere with the attachment of the converter.
2. Place the gasket on the surface reserved for the converter and line it up with the mounting holes.
3. Place the converter on the gasket and line both up with mounting holes.
4. Install screws using appropriate washers and tighten by hand (~ 4 in·oz) in the sequence shown below.

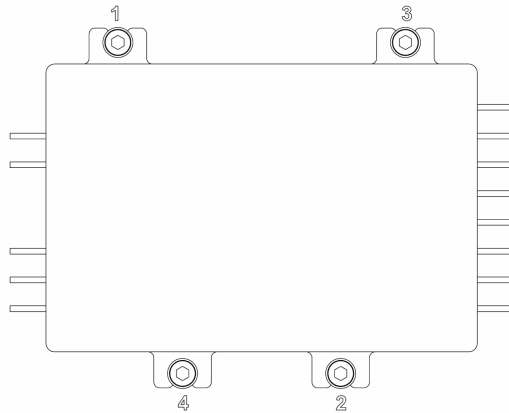

5. Tighten the screws with an appropriate torque driver. Torque the screws up to 6 in·lb in the sequence shown above.

M3G-SERIES
(28V Input, Triple Output)

Mechanical Diagram

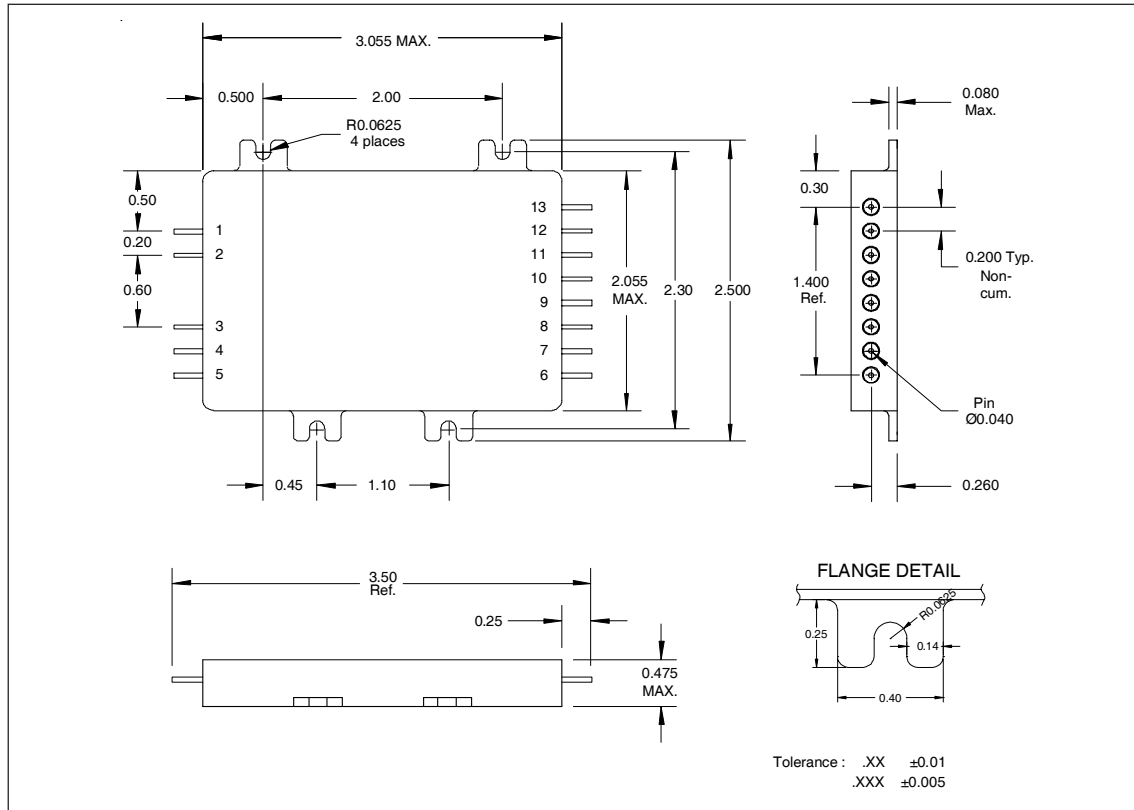

Pin Designation (Triple Output)

| Pin # | Designation | Pin # | Designation |
|-------|---------------|-------|--------------------|
| 1 | + Input | 8 | NC |
| 2 | Input Return | 9 | NC |
| 3 | Inhibit | 10 | Case Ground |
| 4 | Sync. Input | 11 | - Aux. Output |
| 5 | Sync. Output | 12 | Aux. Output Return |
| 6 | Main Return | 13 | +Aux. Output |
| 7 | + Main Output | | |

Standard Microcircuit Drawing Equivalence Table

| Standard Microcircuit Drawing Number | IR Standard Part Number |
|--------------------------------------|-------------------------|
| 5962-03226 | M3G280512T |
| 5962-03227 | M3G280515T |

Device Screening

| Requirement | MIL-STD-883 Method | No Suffix ② | CK ② | EM |
|---------------------------------|----------------------------------|------------------------------------|------------------------------------|------------------------|
| Temperature Range | — | -55°C to +85°C | -55°C to +85°C | -55°C to +85°C |
| Element Evaluation | MIL-PRF-38534 | Class K | Class K | N/A |
| Non-Destructive Bond Pull | 2023 | Yes | Yes | N/A |
| Internal Visual | 2017 | Yes | Yes | ① |
| Temperature Cycle | 1010 | Cond C | Cond C | Cond C |
| Constant Acceleration | 2001, Y1 Axis | 3000 Gs | 3000 Gs | 3000 Gs |
| PIND | 2020 | Cond A | Cond A | N/A |
| Burn-In | 1015 | 320 hrs @ 125°C (2 x 160 hrs) | 320 hrs @ 125°C (2 x 160 hrs) | 48 hrs @ 125°C |
| Final Electrical (Group A) | MIL-PRF-38534 & Specification | -55°C, +25°C, +85°C | -55°C, +25°C, +85°C | -55°C, +25°C, +85°C |
| PDA | MIL-PRF-38534 | 2% | 2% | N/A |
| Seal, Fine and Gross | 1014 | Cond A, C | Cond A, C | Cond A |
| Radiographic | 2012 | Yes | Yes | N/A |
| External Visual | 2009 | Yes | Yes | ① |

Notes:

① Best commercial practice.

② CK is a DLA Land and Maritime (formerly DSCC) part marking used to designate a Class K compliant hybrid.
 The CK marking does not indicate the hybrid is radiation certified.

No Suffix is a radiation rated device but not available as a DLA Land and Maritime qualified SMD per MIL-PRF-38534.
 International Rectifier currently does not have a DLA Land and Maritime certified Radiation Hardness Assurance Program.

Part Numbering

