



# IQS213/A Datasheet

## IQSwitch® - ProxSense® Series

### 3-Channel Capacitive Touch/Swipe Function Controller

## Overview

### Unparalleled Features

- Sub 5µA\* current consumption (“Zero-Power” electronic switch).
- Internal Capacitor Implementation (ICI) – Reference capacitor on-chip
- Automatic Tuning Implementation (ATI) - Automatic tuning for optimal operation in various environments & compensation against sensitivity reducing objects
- **IQS213A advised for applications with high load-capacitances and high sensitivity requirements.**

The **IQS213(A)** ProxSense® IC is a fully integrated two or three channel capacitive swipe function sensor with market leading sensitivity and automatic tuning of the sense electrodes. The **IQS213(A)** provides a minimalist implementation requiring few external components, with OTP-option settings and an I<sup>2</sup>C-compatible interface that allow configuration for numerous applications.

### Main Features

- 2 or 3 Channel (Projected or Self Capacitance) Input device
- Swipe Function or Differentiated Touch and Distributed Proximity Electrode Implementation
- Variable User Interface with Adjustable Swipe Function Configuration
- Auto-Off and Advanced Auto-Off Warning Function
- Supply voltage: 1.8V to 3.6V
- Internal voltage regulator and reference capacitor
- Advanced on-chip digital signal processing
- OTP (One Time Programmable) options available
- I<sup>2</sup>C compatible interface
- Low Power Modes (sub 4µA\*)
- Variable Proximity & Touch Thresholds
- Small outline MSOP-10 package

### Applications

- Sanitary ware, toys, office equipment
- Flashlights, headlamps, keychain lights
- Splash- / waterproof devices
- Swipe-to-Unlock / Wake from Standby applications
- Replacement for electro-mechanical switches

### Advantages

- Prevents accidental activation of conventional touch sensors
- Improved digital filtering to reduce external noise
- High immunity against aqueous substances
- Highly adjustable device with continuous data or event driven I<sup>2</sup>C communication

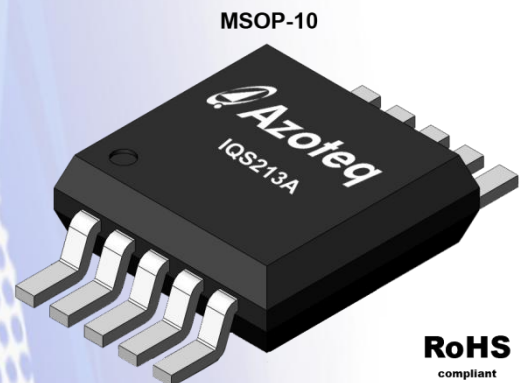

### Available options

| T <sub>A</sub> | MSOP10           |
|----------------|------------------|
| -40°C to 85°C  | IQS213A / IQS213 |

\*Current consumption dependant on selected Low Power settings.



## Contents

|  |           |   |   |    |
|--|-----------|---|---|----|
| <b>OVERVIEW</b> .....                          | <b>1</b>  | 8.3   | SELF- OR PROJECTED CAPACITANCE .....            | 26 |
| <b>1 FUNCTIONAL OVERVIEW</b> .....             | <b>3</b>  | 8.4   | RATE OF CHARGE CYCLES.....                      | 27 |
| 1.1 APPLICABILITY .....                        | 3         | 8.4.1                                       | Normal Power rate.....                          | 27 |
| <b>2 ANALOGUE FUNCTIONALITY</b> .....          | <b>3</b>  | 8.4.2                                       | Low Power rates.....                            | 27 |
| <b>3 DIGITAL FUNCTIONALITY</b> .....           | <b>3</b>  | 8.5   | TOUCH REPORT RATE.....                          | 27 |
| <b>4 HARDWARE CONFIGURATION</b> .....          | <b>4</b>  | 8.6   | ACTIVE CHANNELS .....                           | 27 |
| 4.1 IQS213A (IQS213) - MSOP10 PIN-OUT .....    | 4         | 8.7   | LONG TERM AVERAGE (LTA) .....                   | 28 |
| 4.2 REFERENCE DESIGN .....                     | 5         | 8.8   | DETERMINE TOUCH OR PROX.....                    | 28 |
| 4.2.2 Power Supply and PCB Layout .....        | 5         | 8.9   | ATI .....                                       | 28 |
| 4.2.3 Design Rules for Harsh EMC               |           | 8.9.1                                       | ATI Sensitivity.....                            | 28 |
| Environments .....                             | 6         | 8.9.2                                       | ATI Target.....                                 | 28 |
| 4.2.4 High Sensitivity.....                    | 6         | 8.9.3                                       | ATI Base (MULTIPLIER) .....                     | 28 |
| <b>5 USER CONFIGURABLE OPTIONS</b> .....       | <b>7</b>  | 8.9.4                                       | Re-ATI .....                                    | 29 |
| 5.1 CONFIGURING OF DEVICES .....               | 7         | 8.10  | RF DETECTION.....                               | 29 |
| 5.2 USER SELECTABLE CONFIGURATION OPTIONS..    | 8         | 8.10.1                                      | RF detector sensitivity.....                    | 29 |
| 5.3 IQS213A (IQS213) SETUP EXAMPLES.....       | 14        | <b>9 COMMUNICATION</b> .....                | <b>30</b>                                       |    |
| 5.3.1 Example 1: 3-Channel Self Capacitive,    |           | 9.1   | EVENT MODE .....                                | 30 |
| Active Low Logic Output, SwipeSwitch with      |           | 9.2   | I <sup>2</sup> C SPECIFIC COMMANDS.....         | 30 |
| Auxiliary Touch Output. ....                   | 14        | 9.2.1                                       | IC Reset indication .....                       | 30 |
| 5.3.2 Example 2: 3-Channel Projected           |           | 9.2.2                                       | WDT .....                                       | 30 |
| Capacitive, Active High Logic Output,          |           | 9.3   | I <sup>2</sup> C READ AND WRITE SPECIFICS ..... | 30 |
| SwipeSwitch with Auxiliary Swipe Pulse Output. | 15        | <b>10 IQS213A (IQS213) MEMORY MAP</b> ..... | <b>31</b>                                       |    |
| 5.3.3 Example 3: Normal Mode Operation ....    | 16        | 10.1  | MEMORY REGISTERS .....                          | 31 |
| <b>6 DESCRIPTION OF USER SELECTABLE</b>        |           | 10.2  | MEMORY REGISTERS DESCRIPTION .....              | 33 |
| <b>OPTIONS</b> .....                           | <b>18</b> | 10.2.1                                      | Device Information .....                        | 33 |
| 6.1 IQS213A (IQS213) IC TYPE .....             | 18        | 10.2.2                                      | Device Specific Data .....                      | 34 |
| 6.2 SELF- / PROJECTED CAPACITANCE .....        | 18        | 10.2.3                                      | Current Sample (CS) or Count Data.              | 35 |
| 6.2.1 Capacitive Sense Electrode Design        |           | 10.2.4                                      | Device Settings .....                           | 37 |
| Samples .....                                  | 19        | <b>11 ELECTRICAL SPECIFICATIONS – ALL</b>   |   |    |
| 6.3 FLOAT RX.....                              | 19        | <b>PRELIMINARY</b> .....                    | <b>40</b>                                       |    |
| 6.4 OUTPUT LOGIC SELECT.....                   | 19        | 11.1  | ABSOLUTE MAXIMUM SPECIFICATIONS .....           | 40 |
| 6.5 HALT TIME .....                            | 20        | 11.2  | GENERAL CHARACTERISTICS (MEASURED AT            |    |
| 6.6 LOW POWER MODES .....                      | 20        | 25°C) 40                                    | TIMING CHARACTERISTICS .....                    | 42 |
| 6.7 PROXIMITY THRESHOLD .....                  | 21        | <b>12 PACKAGING INFORMATION</b> .....       | <b>43</b>                                       |    |
| 6.8 TOUCH THRESHOLDS.....                      | 21        | FIGURE 12.1 MSOP-10 BACK VIEW. ....         | 43  |    |
| 6.9 IQS213A (IQS213) SWIPE UI .....            | 22        | FIGURE 12.2 MSOP-10 SIDE VIEW. ....         | 43  |    |
| 6.10 ZERO STATES ALLOWED .....                 | 22        | FIGURE 12.3 MSOP-10 TOP VIEW.....           | 43  |    |
| 6.11 END ON ZERO STATE .....                   | 22        | FIGURE 12.4 MSOP-10 FOOTPRINT. ....         | 43  |    |
| 6.12 STATE TIMES .....                         | 22        | <b>13 DEVICE MARKING</b> .....              | <b>44</b>                                       |    |
| 6.12.1 Minimum State Time .....                | 22        | 13.1  | TOP MARKING .....                               | 44 |
| 6.12.2 Maximum State Time .....                | 23        | 13.2  | BOTTOM MARKING .....                            | 44 |
| 6.12.3 Overall State Time .....                | 23        | <b>14 ORDERING INFORMATION</b> .....        | <b>45</b>                                       |    |
| 6.13 TOUCH/SWIPE (PIN7) OUTPUT.....            | 23        | 14.1  | GENERAL PART ORDER NUMBER .....                 | 45 |
| 6.14 AC FILTER.....                            | 23        | <b>15 CONTACT INFORMATION</b> .....         | <b>46</b>                                       |    |
| 6.15 ATI METHOD.....                           | 23        |   |   |    |
| 6.16 BASE VALUE .....                          | 23        |   |   |    |
| 6.17 ATI TARGET VALUE .....                    | 23        |   |   |    |
| 6.18 AUTO-OFF / ADVANCED AUTO-OFF WARNING      | 24        |   |   |    |
| 6.18.1 Advanced Auto-Off Warning (AAOW)        | 24        |   |   |    |
| 6.18.2 AAOW Clear / Reset .....                | 24        |   |   |    |
| 6.19 I <sup>2</sup> C DEBUG .....              | 24        |   |   |    |
| <b>7 ADDITIONAL FEATURES</b> .....             | <b>24</b> |   |   |    |
| 7.1 NOISE DETECTION .....                      | 24        |   |   |    |
| 7.1.1 Notes for layout: .....                  | 24        |   |   |    |
| <b>8 PROXSENSE® MODULE</b> .....               | <b>26</b> |   |   |    |
| 8.1 CHARGE TRANSFER CONCEPTS .....             | 26        |   |   |    |
| 8.2 PROXSENSE® MODULE SETUP.....               | 26        |   |   |    |



## 1 Functional Overview

The **IQS213A (IQS213)** is a two or three channel capacitive proximity and touch sensor with variable swipe function configurations. Additional features include internal voltage regulation and reference capacitor ( $C_S$ ), which enables cost efficient and minimal component designs. The device offers flexible design approaches by allowing the connection of two or three sense antennas in either surface or projected capacitance configurations.

For swipe function applications the device has a single logic output to indicate swipe actions and one complementary output for consecutive swipe/touch activities. The device can also be configured to operate with individual touch outputs, with an additional proximity output when implementing surface capacitance sense electrodes.

Full control by a master device is achieved by configuring the logic outputs in a serial data ( $I^2C$ ) communication option on TO0 (SCL), TO1 (SDA) and TO2 (RDY).

The device automatically tracks slow varying environmental changes via various filters, detects noise and has an Automatic Tuning Implementation (**ATI**) to tune the device for optimal sensitivity.

### 1.1 Applicability

All specifications, except where specifically mentioned otherwise, provided by this datasheet are applicable to the following ranges:

- Temperature:  $-40^{\circ}C$  to  $+85^{\circ}C$
- Supply voltage ( $V_{DDHI}$ ): 1.8V to 3.6V

## 2 Analogue Functionality

For self-capacitance configured sense electrodes the analogue circuitry measures the capacitance of the sense antennas attached to the  $C_X$  pins through a charge transfer process that is periodically initiated

by the digital circuitry. For projected-capacitance configurations the capacitance is measured between the transmit (TX) and receive (CRX) pins. The measuring process is referred to as a conversion and consists of the discharging of  $C_S$  and  $C_X$ , the charging of  $C_X$  and then a series of charge transfers from  $C_X$  to  $C_S$  until a trip voltage is reached. The number of charge transfers required to reach the trip voltage is referred to as the Count (CS) Value.

The capacitance measurement circuitry makes use of an internal  $C_S$  and voltage reference ( $V_{REG}$ ).

The analogue circuitry further provides functionality for:

- Power on reset (POR) detection.
- Brown out detection (BOD).

## 3 Digital Functionality

The digital processing functionality is responsible for:

- Device setup from OTP settings after POR.
- Management of BOD and WDT events.
- Initiation of conversions at the selected rate.
- Processing of CS and execution of algorithms.
- Monitoring and automatic execution of the ATI algorithm.
- Signal processing and digital filtering.
- Detection of PROX and TOUCH events.
- Managing outputs of the device.
- Managing serial communications.
- Manage programming of OTP options.

## 4 Hardware Configuration

### 4.1 IQS213A (IQS213) - MSOP10 Pin-Out

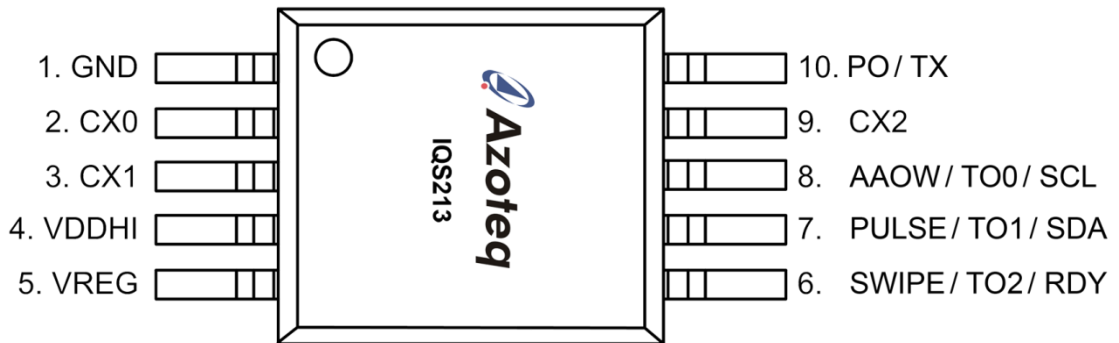

Figure 4.1 : Pin-out of IQS213 Surface package

Table 4.1 : IQS213 Pin-out

| IQS213 Pin-out |               |                              |   |
|----------------|---------------|------------------------------|---|
| Pin            | Name          | Type                         | Function  |
| 1              | GND           | Supply Input                 | Ground Reference  |
| 2              | CX0 (CRX0)    | Analogue                     | Sense Electrode 0   |
| 3              | CX1 (CRX1)    | Analogue                     | Sense Electrode 1   |
| 4              | VDDHI         | Supply Input                 | Supply Voltage Input                                      |
| 5              | VREG          | Analogue Output              | Internal Regulator Pin (Connect 1µF bypass capacitor)     |
| 6              | SWIPE/TO2/RDY | Digital Output               | Swipe Output/Touch Output/I <sup>2</sup> C: RDY Output    |
| 7              | PULSE/T01/SDA | Digital Output               | Pulse Output/Touch Output/I <sup>2</sup> C: SDA Output    |
| 8              | AAOW/TO0/SCL  | Digital I/O                  | Auto-Off Warning/Touch Output/I <sup>2</sup> C: SCL Input |
| 9              | CX2 (CRX2)    | Analogue                     | Sense Electrode 2   |
| 10             | PO/TX         | Digital Output / Transmitter | Proximity Output/ Projected Sense Electrode               |



## 4.2 Reference Design (IQS213A, Self-Capacitance, Active-Low Output)

**\*For IQS213, use C3 = 470nF.**

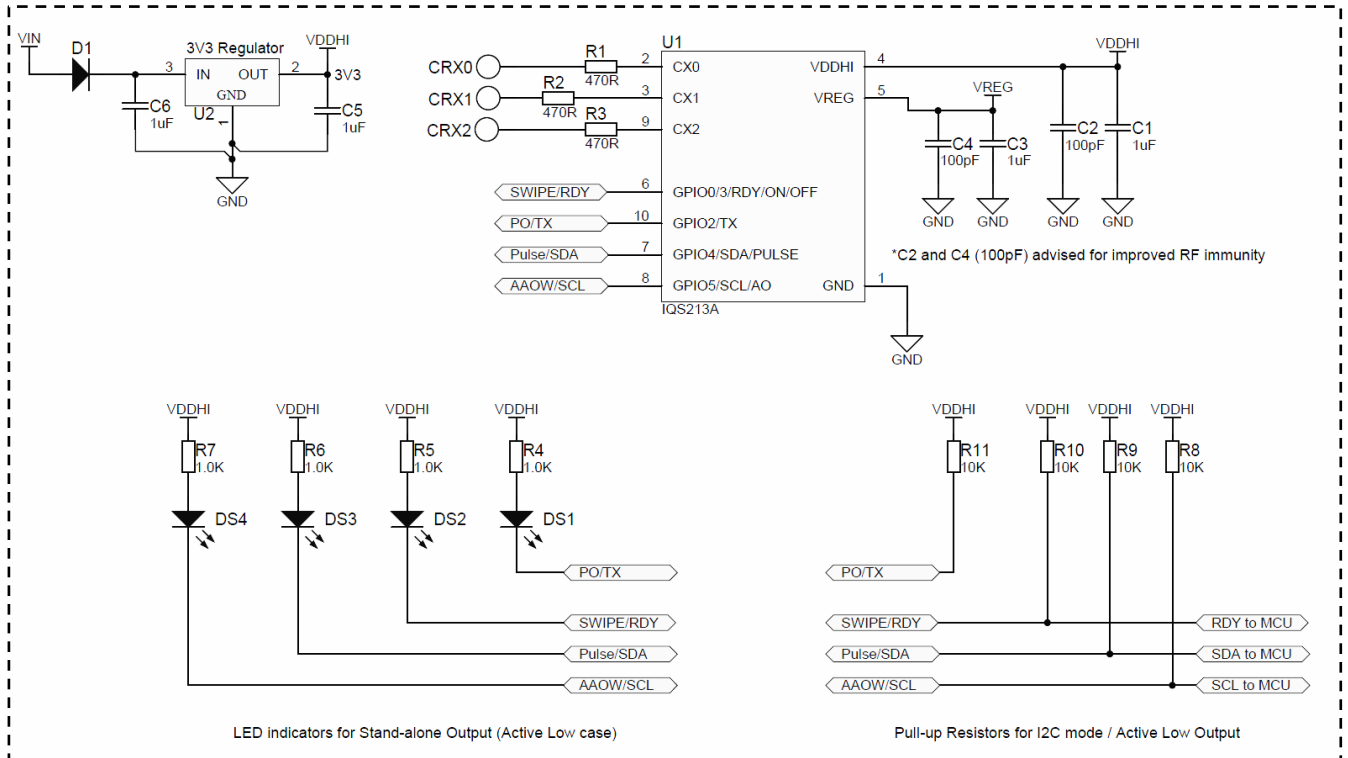

Figure 4.2 : IQS213A Reference Design (Self-Capacitance, Active-Low)

### 4.2.2 Power Supply and PCB Layout

Azoteq IC's provide a high level of on-chip hardware and software noise filtering and ESD protection (refer to application note "**AZD013 – ESD Overview**"). Designing PCB's with better noise immunity against EMI, FTB and ESD in mind, it is always advisable to keep the critical noise suppression components like the de-coupling capacitors and series resistors in **Figure 4.2** as close as possible to the IC. Always maintain a good ground connection and ground pour underneath the IC. For more guidelines please refer to the relevant application notes as mentioned in **Section 4.2.3**.

### 4.2.3 Design Rules for Harsh EMC Environments

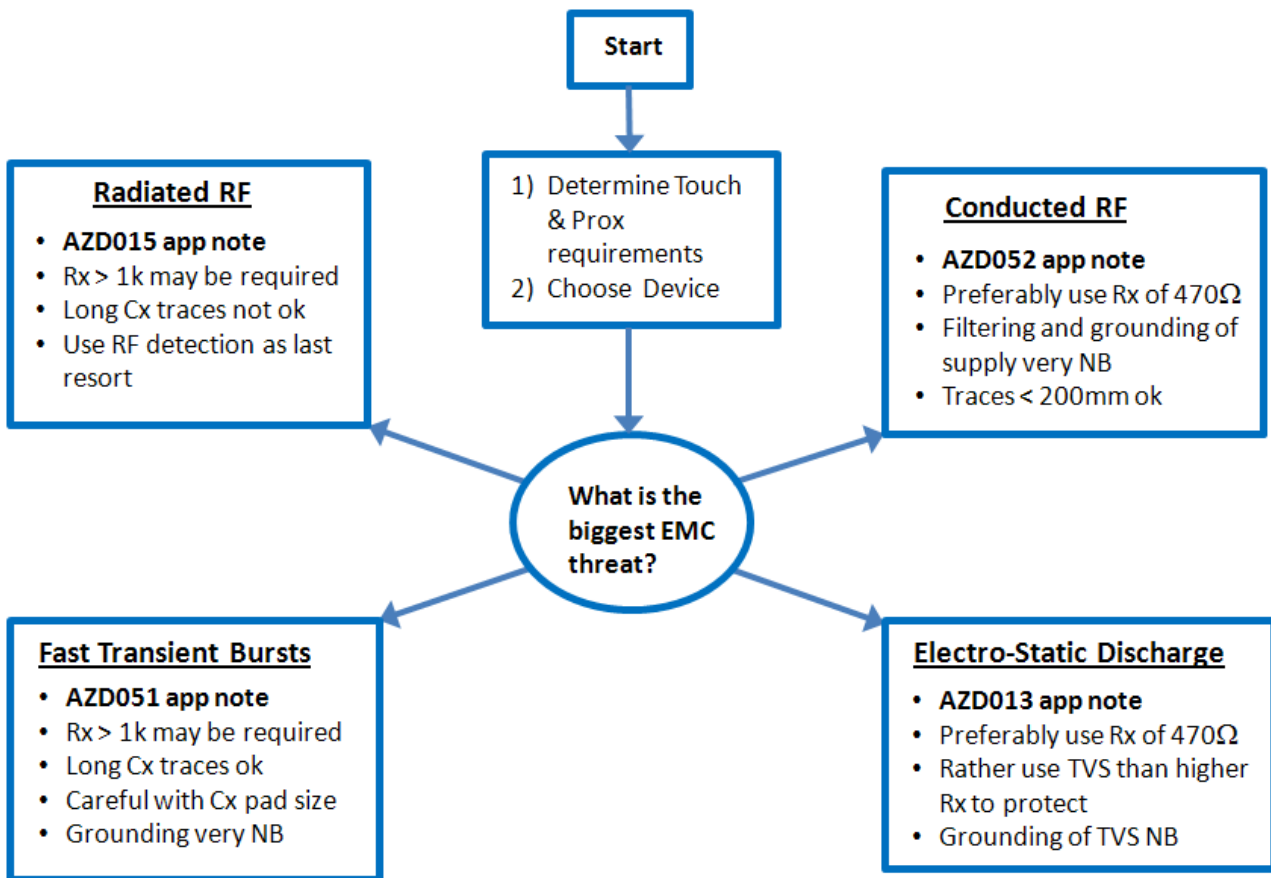

Figure 4.3 : EMC Design Rules

➤ **Applicable application notes: AZD013, AZD015, AZD051, AZD052.**

### 4.2.4 High Sensitivity

Through patented design and advanced signal processing, the device is able to provide extremely high sensitivity to detect proximity. This enables designs to detect proximity at distances that cannot be equaled by most other products. When the device is used in environments where high levels of noise exist, a reduced proximity threshold is proposed to ensure reliable functioning of the sensor.

When the capacitance between the sense antenna and ground becomes too large the sensitivity of the device may be influenced. For more guidelines on layout, please refer to application note **AZD008**, available on the Azoteq web page: [www.azoteq.com](http://www.azoteq.com).



## 5 User Configurable Options

The **IQS213A (IQS213)** provides **One Time Programmable (OTP)** user options (each option can be modified only once). However, with the use of Azoteq's IQS213(A) GUI software, the **IQS213A** can enter streaming mode in a start-up state (*Test Mode*) where the OTP options can be configured and evaluated, before programming.

The device is fully functional in the default (un-configured) state, as a 2-Channel Self-capacitive SwipeSwitch IC.

The configuration of the device can be done on packaged devices or in-circuit. In-circuit configuration may be limited by the type and/or values of external components chosen.

Please see **Section 5.3** for **IQS213A** device setup and output configuration examples.

### 5.1 Configuring of Devices

Azoteq offers a Configuration Tool (CT210 or later) and associated software (USBProg.exe) that can be used to program the OTP user options for prototyping purposes. More details regarding the configuration of the device with the USBProg program can be found in "**AZD007 - USBProg Overview**" available on the Azoteq website.

For further enquiries regarding this subject, please contact your local distributor or submit enquiries to Azoteq at: [ProSenseSupport@azoteq.com](mailto:ProSenseSupport@azoteq.com)



## 5.2 User Selectable Configuration Options

Table 5.1 : User Selectable Configuration Options : Bank 0

| bit7   | Bank 0 |       |          |      |          |          | bit0     |
|--------|--------|-------|----------|------|----------|----------|----------|
| THALT1 | THALT0 | LOGIC | FLOAT RX | PROJ | IC TYPE2 | IC TYPE1 | IC TYPE0 |

|                      |   |                    |
|----------------------|---|--------------------|
| <b>Bank0: bit7:6</b> | <b>THALT1:THALT0: LTA Halt Time</b>   | <b>Section 6.5</b> |
|                      | 00 = 2.5s<br>01 = 20s<br>10 = 60s<br>11 = Never   |                    |
| <b>Bank0: bit5</b>   | <b>LOGIC: Output Logic</b>  | <b>Section 6.4</b> |
|                      | 0 = Active Low <sup>1</sup><br>1 = Active High  |                    |
| <b>Bank0: bit4</b>   | <b>FLOAT RX: Float Sense Electrodes</b>   | <b>Section 6.8</b> |
|                      | 0 = No<br>1 = Yes   |                    |
| <b>Bank0: bit3</b>   | <b>PROJ: Capacitive Technology</b>  | <b>Section 6.2</b> |
|                      | 0 = Self Capacitance<br>1 = Projected Capacitance   |                    |
| <b>Bank0: bit2:0</b> | <b>IC TYPE: Select IC type</b>  | <b>Section 6.1</b> |
|                      | 000 = 1zz 12z z2z                      - 2CH SWIPE<br>001 = 1zz x2x zz3                        - 3CH SWIPE (Thresholds * 2)<br>010 = 1zz z2z zz3                        - 3CH SWIPE<br>011 = 1zz 12z z2z z23 zz3               - 3CH SWIPE<br>100 = 2CH Normal                         - 2 Channel Touch Sensor<br>101 = 3CH Normal                         - 3 Channel Touch Sensor<br>110 = 1zz 1xz x2x zx3 zz3               - 3CH SWIPE<br>111 = 1zz, x2x, zz3                        - 3CH SWIPE |                    |

<sup>1</sup> Active Low configurations are software open-drain (**SW OD**).

**Note:** The proximity output on the PO/TX-pin (pin 10) is multiplexed with the transmit signal (TX) for projected capacitance electrodes, and is Active High ONLY for Projected configurations.





Table 5.2 : User Selectable Configuration Options : Bank 1

| bit7     | Bank 1   |                  |                  |         |         |     | bit0 |
|----------|----------|------------------|------------------|---------|---------|-----|------|
| CH2 TTH1 | CH2 TTH0 | CH1, CH3<br>TTH1 | CH1, CH3<br>TTH0 | TTH ALT | PTH DIV | LP1 | LP0  |

|                         |   |                    |                    |            |                    |            |                    |            |                    |         |         |  |
|-------------------------|---|--------------------|--------------------|------------|--------------------|------------|--------------------|------------|--------------------|---------|---------|--|
| <b>Bank1: bit7:6</b>    | <b>CH2 TTH1:CH2 TTH0: Channel 2 Touch Threshold</b>   | <b>Section 6.8</b> |                    |            |                    |            |                    |            |                    |         |         |  |
|                         | <table style="width: 100%; border-collapse: collapse;"> <tr> <td style="width: 50%;"><i>TTH ALT = 0</i></td> <td style="width: 50%;"><i>TTH ALT = 1</i></td> </tr> <tr> <td>00 = 4</td> <td>00 = 22</td> </tr> <tr> <td>01 = 8</td> <td>01 = 28</td> </tr> <tr> <td>10 = 12</td> <td>10 = 36</td> </tr> <tr> <td>11 = 16</td> <td>11 = 48</td> </tr> </table> | <i>TTH ALT = 0</i> | <i>TTH ALT = 1</i> | 00 = 4     | 00 = 22            | 01 = 8     | 01 = 28            | 10 = 12    | 10 = 36            | 11 = 16 | 11 = 48 |  |
| <i>TTH ALT = 0</i>      | <i>TTH ALT = 1</i>  |                    |                    |            |                    |            |                    |            |                    |         |         |  |
| 00 = 4                  | 00 = 22   |                    |                    |            |                    |            |                    |            |                    |         |         |  |
| 01 = 8                  | 01 = 28   |                    |                    |            |                    |            |                    |            |                    |         |         |  |
| 10 = 12                 | 10 = 36   |                    |                    |            |                    |            |                    |            |                    |         |         |  |
| 11 = 16                 | 11 = 48   |                    |                    |            |                    |            |                    |            |                    |         |         |  |
| <b>Bank1: bit5:bit4</b> | <b>CH1, CH3 TTH: Ch 1 &amp; Ch 3 Touch Threshold</b>  | <b>Section 6.8</b> |                    |            |                    |            |                    |            |                    |         |         |  |
|                         | <table style="width: 100%; border-collapse: collapse;"> <tr> <td style="width: 50%;"><i>TTH ALT = 0</i></td> <td style="width: 50%;"><i>TTH ALT = 1</i></td> </tr> <tr> <td>00 = 4</td> <td>00 = 22</td> </tr> <tr> <td>01 = 8</td> <td>01 = 28</td> </tr> <tr> <td>10 = 12</td> <td>10 = 36</td> </tr> <tr> <td>11 = 16</td> <td>11 = 48</td> </tr> </table> | <i>TTH ALT = 0</i> | <i>TTH ALT = 1</i> | 00 = 4     | 00 = 22            | 01 = 8     | 01 = 28            | 10 = 12    | 10 = 36            | 11 = 16 | 11 = 48 |  |
| <i>TTH ALT = 0</i>      | <i>TTH ALT = 1</i>  |                    |                    |            |                    |            |                    |            |                    |         |         |  |
| 00 = 4                  | 00 = 22   |                    |                    |            |                    |            |                    |            |                    |         |         |  |
| 01 = 8                  | 01 = 28   |                    |                    |            |                    |            |                    |            |                    |         |         |  |
| 10 = 12                 | 10 = 36   |                    |                    |            |                    |            |                    |            |                    |         |         |  |
| 11 = 16                 | 11 = 48   |                    |                    |            |                    |            |                    |            |                    |         |         |  |
| <b>Bank1: bit3</b>      | <b>TTH ALT: Alternative Touch Thresholds</b>  | <b>Section 6.8</b> |                    |            |                    |            |                    |            |                    |         |         |  |
|                         | 0 = No<br>1 = Yes   |                    |                    |            |                    |            |                    |            |                    |         |         |  |
| <b>Bank1: bit2</b>      | <b>PTH: Proximity Threshold Selection</b>   | <b>Section 6.7</b> |                    |            |                    |            |                    |            |                    |         |         |  |
|                         | 0 = 3 Counts    ( <i>IQS213: PTH = CH1 TTH / 2</i> )<br>1 = 8 Counts    ( <i>IQS213: PTH = CH1 TTH / 4</i> )  |                    |                    |            |                    |            |                    |            |                    |         |         |  |
| <b>Bank1: bit1:0</b>    | <b>LP1:LP0: Low Power Selection</b>   | <b>Section 6.6</b> |                    |            |                    |            |                    |            |                    |         |         |  |
|                         | <table style="width: 100%; border-collapse: collapse;"> <tr> <td style="width: 50%;">00 = NP</td> <td style="width: 50%;">- Normal Power</td> </tr> <tr> <td>01 = 128ms</td> <td>- Low Power Mode 1</td> </tr> <tr> <td>10 = 256ms</td> <td>- Low Power Mode 2</td> </tr> <tr> <td>11 = 512ms</td> <td>- Low Power Mode 3</td> </tr> </table>                 | 00 = NP            | - Normal Power     | 01 = 128ms | - Low Power Mode 1 | 10 = 256ms | - Low Power Mode 2 | 11 = 512ms | - Low Power Mode 3 |         |         |  |
| 00 = NP                 | - Normal Power  |                    |                    |            |                    |            |                    |            |                    |         |         |  |
| 01 = 128ms              | - Low Power Mode 1  |                    |                    |            |                    |            |                    |            |                    |         |         |  |
| 10 = 256ms              | - Low Power Mode 2  |                    |                    |            |                    |            |                    |            |                    |         |         |  |
| 11 = 512ms              | - Low Power Mode 3  |                    |                    |            |                    |            |                    |            |                    |         |         |  |



**Table 5.3 : User Selectable Configuration Options : Bank 2**

| bit7 | Bank 2: SWIPE IC |         |           |          |            |           | bit0      |
|------|------------------|---------|-----------|----------|------------|-----------|-----------|
| ACF  | Pin7_OUT         | CHG_FRQ | Min_State | Zero_End | Zero_State | SWIPE UI1 | SWIPE UI0 |

|                          |   |                     |
|--------------------------|---|---------------------|
| <b>Bank2: bit7</b>       | <b>ACF: AC Filter Selection</b>   | <b>Section 6.14</b> |
|                          | 0 = Disabled<br>1 = Enabled   |                     |
| <b>Bank2: bit6</b>       | <b>Pin7_OUT: SWIPE IC Pin 7 Output Selection</b>  | <b>Section 6.13</b> |
|                          | 0 = Touch<br>1 = Pulse  |                     |
| <b>Bank2: bit5</b>       | <b>CHG_FRQ: Charge Transfer Frequency</b>   | <b>Section 8.3</b>  |
|                          | 0 = 0.5MHz / 1.0MHz (Self - / Projected Capacitance)<br>1 = 1.0MHz / 2.0 MHz (Self - / Projected Capacitance) |                     |
| <b>Bank2: bit4</b>       | <b>Min_State: Minimum State Time</b>  | <b>Section 6.12</b> |
|                          | 0 = 1 Sample<br>1 = 2 Samples   |                     |
| <b>Bank2: bit3</b>       | <b>Zero_End: End Swipe on Zero State (zzz)</b>  | <b>Section 6.11</b> |
|                          | 0 = Disabled<br>1 = Enabled   |                     |
| <b>Bank2: bit 2</b>      | <b>Zero_State: Allow Zero States In Swipe Sequence</b>  | <b>Section 6.10</b> |
|                          | 0 = Disabled<br>1 = Enabled   |                     |
| <b>Bank2: bit 1:bit0</b> | <b>SWIPE UI1: SWIPE UI0: Swipe UI Selection</b>   | <b>Section 6.9</b>  |
|                          | 00 = Single Direction<br>01 = Bi-Directional<br>10 = Directional<br>11 = Dual Swipe                           |                     |



Table 5.4 : User Selectable Configuration Options : Bank 2

| bit7 | Bank 2: Normal Touch IC |         |  |  |            |            | bit0       |
|------|-------------------------|---------|--|--|------------|------------|------------|
| ACF  |                         | CHG_FRQ |  |  | Toggle CH3 | Toggle CH2 | Toggle CH1 |

|                     |   |                     |
|---------------------|---|---------------------|
| <b>Bank2: bit7</b>  | <b>ACF: AC Filter Selection</b>   | <b>Section 6.14</b> |
|                     | 0 = Disabled<br>1 = Enabled   |                     |
| <b>Bank2: bit6</b>  |   |                     |
| <b>Bank2: bit5</b>  | <b>CHG_FRQ: Charge Transfer Frequency</b>   | <b>Section 8.3</b>  |
|                     | 0 = 0.5MHz / 1.0MHz (Self - / Projected Capacitance)<br>1 = 1.0MHz / 2.0 MHz (Self - / Projected Capacitance) |                     |
| <b>Bank2: bit4</b>  |   |                     |
| <b>Bank2: bit3</b>  |   |                     |
| <b>Bank2: bit 2</b> | <b>Toggle CH3: Channel 3 Touch Output = Toggle</b>  |                     |
|                     | 0 = Disabled<br>1 = Enabled   |                     |
| <b>Bank2: bit 1</b> | <b>Toggle CH2: Channel 2 Touch Output = Toggle</b>  |                     |
|                     | 0 = Disabled<br>1 = Enabled   |                     |
| <b>Bank2: bit 0</b> | <b>Toggle CH1: Channel 1 Touch Output = Toggle</b>  |                     |
|                     | 0 = Disabled<br>1 = Enabled   |                     |



Table 5.5 : User Selectable Configuration Options : Bank 3

| bit7 | Bank 3 |  |  |         |     |            | bit0     |
|------|--------|--|--|---------|-----|------------|----------|
|      |        |  |  | AAO_CLR | AAO | ATI_Target | ATI_Base |

| <b>Bank3: bit7</b>  | <b>System Use</b>  |                     |                  |              |     |     |     |     |     |     |  |
|---------------------|--|---------------------|------------------|--------------|-----|-----|-----|-----|-----|-----|--|
| <b>Bank3: bit6</b>  | <b>System Use</b>  |                     |                  |              |     |     |     |     |     |     |  |
| <b>Bank3: bit5</b>  | <b>System Use</b>  |                     |                  |              |     |     |     |     |     |     |  |
| <b>Bank3: bit4</b>  | <b>System Use</b>  |                     |                  |              |     |     |     |     |     |     |  |
| <b>Bank3: bit3</b>  | <b>AAO_CLR: Clear Auto-Off Timer On Event</b>  | <b>Section 6.18</b> |                  |              |     |     |     |     |     |     |  |
|                     | 0 = Touch Event<br>1 = Proximity Event   |                     |                  |              |     |     |     |     |     |     |  |
| <b>Bank3: bit 2</b> | <b>AAO: Advanced Auto-Off Function Selection</b>   | <b>Section 6.18</b> |                  |              |     |     |     |     |     |     |  |
|                     | 0 = Enabled<br>1 = Disabled  |                     |                  |              |     |     |     |     |     |     |  |
| <b>Bank3: bit 1</b> | <b>ATI_Target: ATI Target Value</b>  | <b>Section 6.17</b> |                  |              |     |     |     |     |     |     |  |
|                     | <table style="margin-left: auto; margin-right: auto;"> <thead> <tr> <th></th> <th style="text-align: center;"><i>Proximity</i></th> <th style="text-align: center;"><i>Touch</i></th> </tr> </thead> <tbody> <tr> <td>0 =</td> <td style="text-align: center;">320</td> <td style="text-align: center;">160</td> </tr> <tr> <td>1 =</td> <td style="text-align: center;">640</td> <td style="text-align: center;">320</td> </tr> </tbody> </table> |                     | <i>Proximity</i> | <i>Touch</i> | 0 = | 320 | 160 | 1 = | 640 | 320 |  |
|                     | <i>Proximity</i>   | <i>Touch</i>        |                  |              |     |     |     |     |     |     |  |
| 0 =                 | 320  | 160                 |                  |              |     |     |     |     |     |     |  |
| 1 =                 | 640  | 320                 |                  |              |     |     |     |     |     |     |  |
| <b>Bank3: bit 0</b> | <b>ATI_Base: ATI Base Value (All Channels)</b>   | <b>Section 6.16</b> |                  |              |     |     |     |     |     |     |  |
|                     | 0 = 75     ( <i>IQS213: 0 = 50</i> )<br>1 = 100    ( <i>IQS213: 1 = 100</i> )  |                     |                  |              |     |     |     |     |     |     |  |



Table 5.6 : User Selectable Configuration Options : Bank 4

| bit7 | Bank 4 |  |  |                        |  |  | bit0 |
|------|--------|--|--|------------------------|--|--|------|
|      |        |  |  | I <sup>2</sup> C Debug |  |  |      |

|                     |  |
|---------------------|--|
| <b>Bank4: bit7</b>  | <b>System Use</b>  |
| <b>Bank4: bit6</b>  | <b>System Use</b>  |
| <b>Bank4: bit5</b>  | <b>System Use</b>  |
| <b>Bank4: bit4</b>  | <b>System Use</b>  |
| <b>Bank4: bit3</b>  | <b>I<sup>2</sup>C Debug: I<sup>2</sup>C Interface (Default = Event-Mode)</b> <span style="float: right;"><b>Section 6.19</b></span><br>0 = Disabled<br>1 = Enabled |
| <b>Bank4: bit 2</b> | <b>System Use</b>  |
| <b>Bank4: bit 1</b> | <b>System Use</b>  |
| <b>Bank4: bit 0</b> | <b>System Use</b>  |



## 5.3 IQS213A (IQS213) Setup Examples

### 5.3.1 Example 1: 3-Channel Self Capacitive, Active Low Logic Output, SwipeSwitch with Auxiliary Touch Output.

Example 1 (see **Figure 5.1**) illustrates the user interface (UI) and device outputs for a **3-Channel Self Capacitive SwipeSwitch** (output on pin 6), in an active low configuration with the Directional UI and Auxiliary **Touch** Output on pin 7.

#### 5.3.1.1 Selected User Configuration Options (Example 1):

| bit7   | Bank 0 |       |          |      |          |          | bit0     |
|--------|--------|-------|----------|------|----------|----------|----------|
| THALT1 | THALT0 | LOGIC | FLOAT RX | PROJ | IC TYPE2 | IC TYPE1 | IC TYPE0 |
| 0      | 0      | 0     | N/A      | 0    | *        | *        | *        |

\*\*\* The IC TYPE can be any 3-Channel SwipeSwitch™ option, e.g. 001,110 or 111.

THALT1:0 = 00 – 2.5s Halt time selected for this example.

| bit7     | Bank 1   |               |               |         |         |     | bit0 |
|----------|----------|---------------|---------------|---------|---------|-----|------|
| CH2 TTH1 | CH2 TTH0 | CH1, CH3 TTH1 | CH1, CH3 TTH0 | TTH ALT | PTH DIV | LP1 | LP0  |
| N/A      | N/A      | N/A           | N/A           | N/A     | N/A     | N/A | N/A  |

| bit7 | Bank 2: SWIPE IC |         |           |          |            |           | bit0      |
|------|------------------|---------|-----------|----------|------------|-----------|-----------|
| ACF  | Pin7_OUT         | CHG_FRQ | Min_State | Zero_End | Zero_State | SWIPE UI1 | SWIPE UI0 |
| N/A  | 0                | N/A     | N/A       | N/A      | N/A        | 1         | 0         |

| bit7 | Bank 4 |  |  |                        |  |  | bit0 |
|------|--------|--|--|------------------------|--|--|------|
|      |        |  |  | I <sup>2</sup> C Debug |  |  |      |
|      |        |  |  | 0                      |  |  |      |

#### 5.3.1.2 Device outputs (Directional SwipeSwitch™ UI)

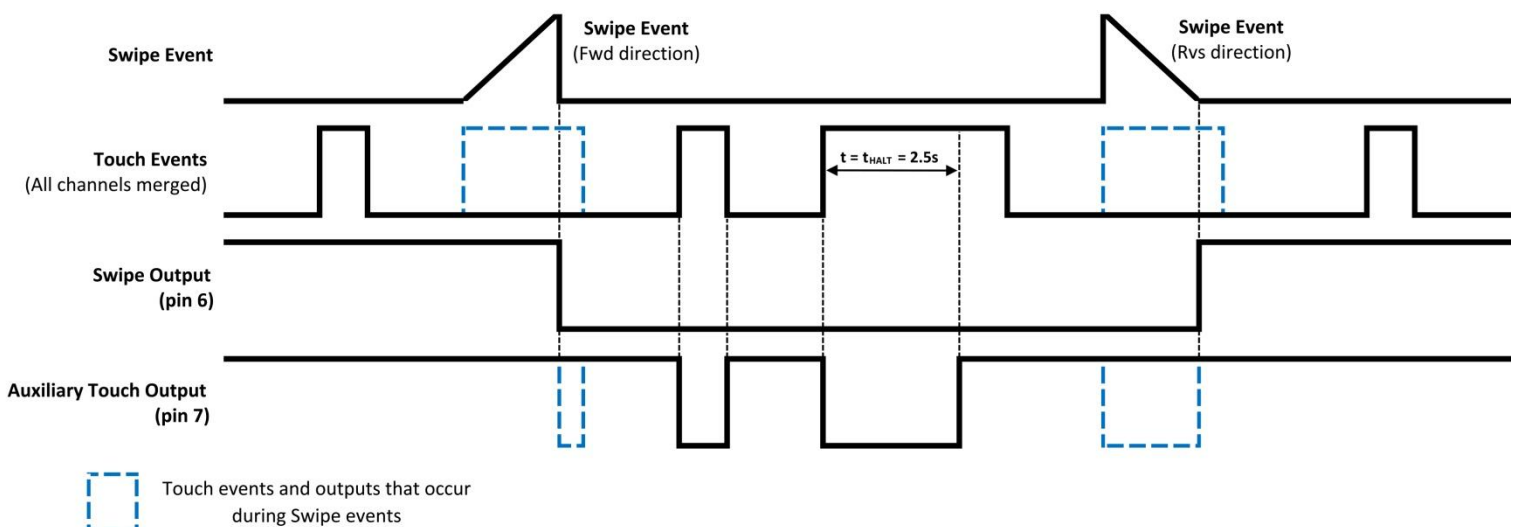

Figure 5.1 : IQS213A (IQS213) setup example 1



### 5.3.2 Example 2: 3-Channel Projected Capacitive, Active High Logic Output, SwipeSwitch with Auxiliary Swipe Pulse Output.

Example 2 (see **Figure 5.2**) illustrates the user interface (UI) and device outputs for a **3-Channel Projected Capacitive SwipeSwitch** (output on pin 6), in an active high configuration with the Bi-Directional UI and Auxiliary **Swipe Pulse** Output on pin 7.

#### 5.3.2.1 Selected User Configuration Options (Example 2):

| bit7   | Bank 0 |       |          |      |          |          | bit0     |
|--------|--------|-------|----------|------|----------|----------|----------|
| THALT1 | THALT0 | LOGIC | FLOAT RX | PROJ | IC TYPE2 | IC TYPE1 | IC TYPE0 |
| N/A    | N/A    | 1     | N/A      | 1    | *        | *        | *        |

\*\*\* The IC TYPE can be any 3-Channel SwipeSwitch option, e.g. 001,110 or 111.

| bit7     | Bank 1   |               |               |         |         |     | bit0 |
|----------|----------|---------------|---------------|---------|---------|-----|------|
| CH2 TTH1 | CH2 TTH0 | CH1, CH3 TTH1 | CH1, CH3 TTH0 | TTH ALT | PTH DIV | LP1 | LP0  |
| N/A      | N/A      | N/A           | N/A           | N/A     | N/A     | N/A | N/A  |

| bit7 | Bank 2: SWIPE IC |         |           |          |            |           | bit0      |
|------|------------------|---------|-----------|----------|------------|-----------|-----------|
| ACF  | Pin7_OUT         | CHG_FRQ | Min_State | Zero_End | Zero_State | SWIPE UI1 | SWIPE UI0 |
| N/A  | 1                | N/A     | N/A       | N/A      | N/A        | 0         | 1         |

Pin7\_OUT = 1 : The output on pin 7 will be a pulse signal \*(within a 2-second window), of which the pulse length depends on the direction of the swipe event. See Section 6.13. \*The 2-second window is reset after each swipe event.

| bit7 | Bank 4 |  |  |                        |  |  | bit0 |
|------|--------|--|--|------------------------|--|--|------|
|      |        |  |  | I <sup>2</sup> C Debug |  |  |      |
|      |        |  |  | 0                      |  |  |      |

#### 5.3.2.2 Device outputs (Bi-Directional SwipeSwitch UI)

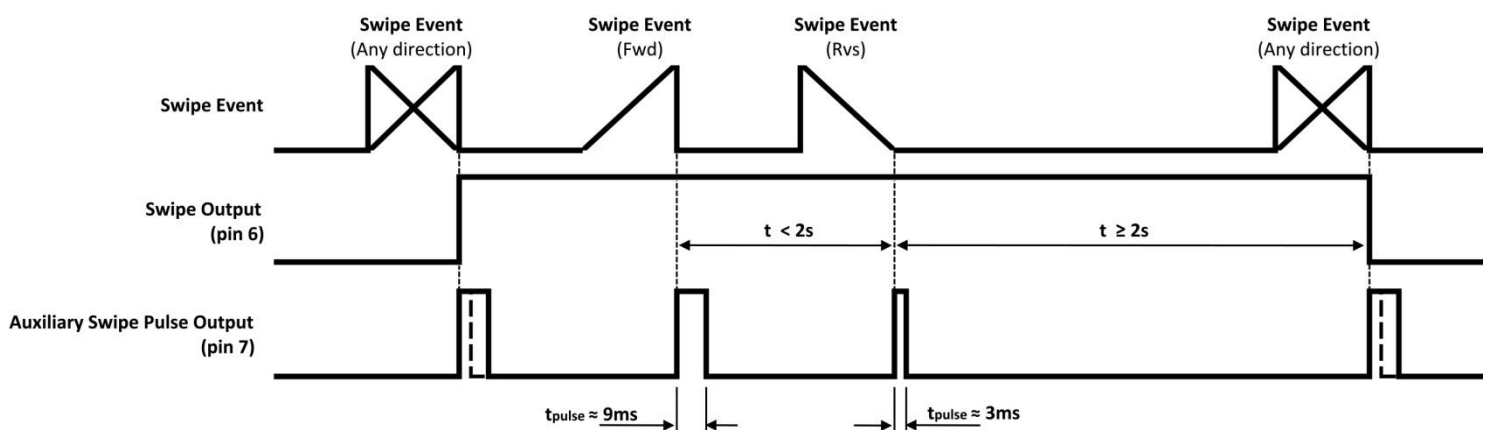

**Figure 5.2 : IQS213A (IQS213) Setup example 2**



### 5.3.3 Example 3: Normal Mode Operation

Example 3 illustrates the user interface (UI) and device outputs for a **2- or 3-Channel Normal Mode (TOUCH) Device**, with optional toggle state outputs. Note that the lower three bits of Bank2 are reserved for Toggle options, when the IC TYPE is selected in a Normal Mode configuration. The Normal Mode (i.e Touch) device can be either Self- or Projected Capacitive with either Active High or Active Low (Logic) outputs.

#### 5.3.3.1 Example 3.1: 2-Channel Normal Mode – No Toggle Active, Active Low Logic

| bit7   | Bank 0 |       |          |      |          |          | bit0     |
|--------|--------|-------|----------|------|----------|----------|----------|
| THALT1 | THALT0 | LOGIC | FLOAT RX | PROJ | IC TYPE2 | IC TYPE1 | IC TYPE0 |
| N/A    | N/A    | 0     | N/A      | N/A  | 1        | 0        | 0        |

| bit7 | Bank 2: Normal Touch IC |         |  |  |            |            | bit0       |
|------|-------------------------|---------|--|--|------------|------------|------------|
| ACF  |                         | CHG_FRQ |  |  | Toggle CH3 | Toggle CH2 | Toggle CH1 |
| N/A  |                         | N/A     |  |  | 0          | 0          | 0          |

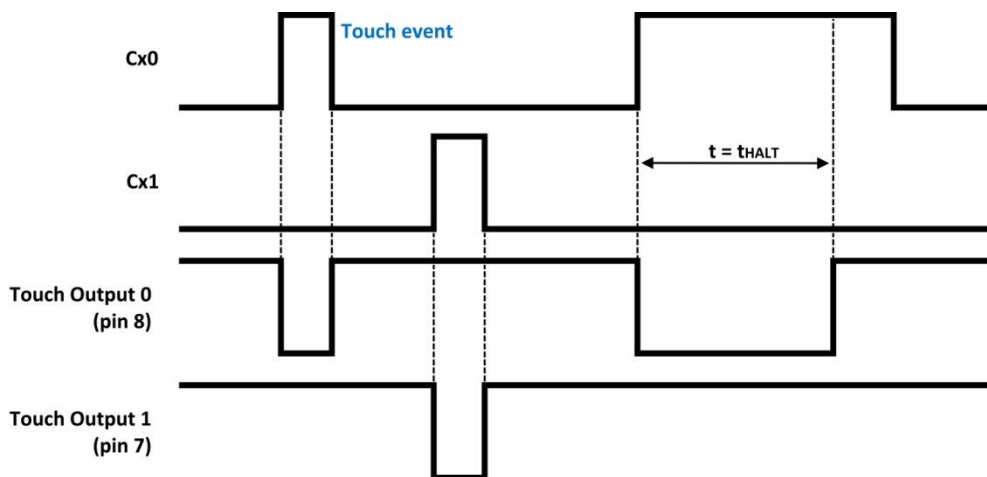

Figure 5.3 : IQS213A (IQS213) Setup example 3.1

#### 5.3.3.2 Example 3.2: 3-Channel Normal Mode – All Toggles Active, Active High Logic

| bit7   | Bank 0 |       |          |      |          |          | bit0     |
|--------|--------|-------|----------|------|----------|----------|----------|
| THALT1 | THALT0 | LOGIC | FLOAT RX | PROJ | IC TYPE2 | IC TYPE1 | IC TYPE0 |
| N/A    | N/A    | 1     | N/A      | N/A  | 1        | 0        | 1        |

| bit7 | Bank 2: Normal Touch IC |         |  |  |            |            | bit0       |
|------|-------------------------|---------|--|--|------------|------------|------------|
| ACF  |                         | CHG_FRQ |  |  | Toggle CH3 | Toggle CH2 | Toggle CH1 |
| N/A  |                         | N/A     |  |  | 1          | 1          | 1          |



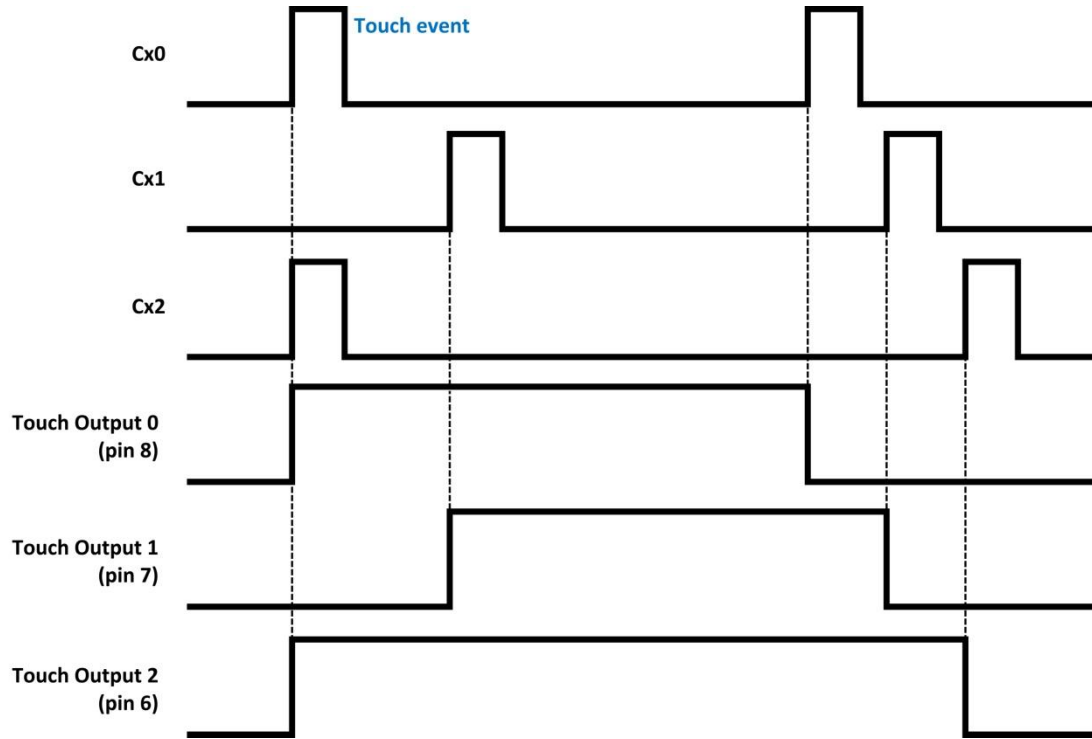

Figure 5.4 : IQS213A (IQS213) Setup example 3.2



## 6 Description of User Selectable Options

This section briefly describes the individual user programmable options of the **IQS213A (IQS213)**, with additional information and detailed descriptions being provided in **Section 8**.

Thresholds and other settings can also be evaluated in Test Mode streaming without programming the OTP options. For the appropriate software, please visit: [www.azoteq.com](http://www.azoteq.com)

### 6.1 IQS213A (IQS213) IC Type

The **IQS213(A)** has 6 selectable SwipeSwitch setup configurations, allowing the user maximum freedom in the design of the intended application. The device type configuration specifies the required user input, which is identified by a sequence of a combination of input states, where a *[number]* (e.g. 1, 2 or 3) indicates a touch condition/state on that specific channel, a *[z-character]* indicates a zero condition/state and a *[x-character]* indicates a “don't care” condition/state (i.e. a number or zero condition is acceptable). The input states related to sequences accepting x-character conditions are also referred to as relaxed states.

- **2CH SWIPE - 1zz 12z z2z** :  
2-Channel swipe switch operation.
- **3CH SWIPE – 1zz x2x zz3 (TH\*2)** :  
3-Channel swipe switch operation.
- **3CH SWIPE - 1zz z2z zz3** :  
3-Channel swipe switch operation.
- **3CH SWIPE - 1zz 12z z2z z23 zz3** :  
3-Channel swipe switch operation.
- **3CH SWIPE - 1zz 1xz x2x zx3 zz3** :  
3-Channel swipe with relaxed states.
- **3CH SWIPE - 1zz x2x zz3** :  
3-Channel swipe with relaxed states.

The **IQS213(A)** also has 2 selectable normal setup configurations, which allows the user to implement standard touch and proximity sensing features.

- **2CH Normal Mode** :  
2-Channel Normal Touch operation.
- **3CH Normal Mode** :  
3-Channel Normal Touch operation.

With the device setup in either 2-channel or 3-channel Normal Mode, touch events corresponding to the different sense electrodes will be output on TO0 (pin 8), TO1 (pin 7) and TO2 (pin 6), with a proximity output available on PO (pin 10).

During Normal Mode operation, setting the different “Toggle\_CHX” bits in Bank 2, will enable the touch output signals to toggle.

### 6.2 Self- / Projected Capacitance

Enabling the projected capacitance option, will cause the measurement of the sense electrode capacitance between the transmit (TX) and receive (CRX) pins.

The proximity output on the PO/TX-pin (pin 10) is multiplexed with the transmit signal (TX) for projected capacitance electrodes, and is Active High ONLY for such configurations.

The implementation of a projected capacitance sense electrode will result in a higher charge frequency (i.e.  $f_{cm} = 1\text{MHz}$ ) compared to that of a self capacitance configuration (i.e.  $f_{cs} = 500\text{kHz}$ ). Setting bit5 in Bank2 will double the charge frequency for both projected- and self capacitance configurations (i.e.  $f_{cm} / f_{cs} = 2\text{MHz} / 1\text{MHz}$ ).

A higher charge frequency selection is preferred for increased immunity against aqueous substances when used in most projected capacitance configurations.

## 6.2.1 Capacitive Sense Electrode Design Samples

### 6.2.1.1 Self Capacitance Electrodes

#### 2-Channel Self Capacitance Electrode



#### 3-Channel Self Capacitance Electrode



Figure 6.1 : Self Capacitance Swipe Switch Sample Electrodes.

### 6.2.1.2 Projected Capacitance Electrodes

#### 2-Channel Projected Capacitance Electrode

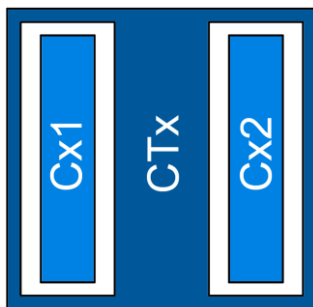

#### 3-Channel Projected Capacitance Electrode

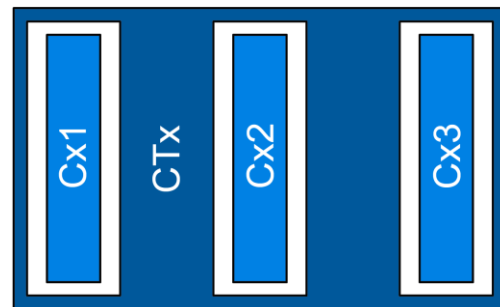

Figure 6.2 : Projected Capacitance Swipe Switch Sample Electrodes.

## 6.3 Float Rx

During the charge transfer process (see **Figure 8.1**) the channels that are not being processed during the current cycle, is effectively grounded to decrease the effects of noise-coupling between the sense electrodes. Selecting the "Float RX" option (Bank0 bit4), will thus result in the non-current channels to float (i.e. not grounded) during the charge cycle of the current channel.

## 6.4 Output Logic Select

The **IQS213(A)** can be set to sink or source current in stand-alone mode (I<sup>2</sup>C Debug =

Disabled), by setting the logic output Active High (Push-Pull) or Active Low (SW OD).

For Active Low operation, the device output pins are set in a software open-drain (SW OD) configuration, which requires the use of external pull-up resistors on the output pins.

The proximity output on the PO/TX-pin (pin 10) is multiplexed with the transmit signal (TX) for projected capacitance electrodes, and is Active High ONLY for Projected configurations. Thus for self capacitance configurations, the proximity output on PO (pin10) depends on the selected output logic (Bank0 bit5).



## 6.5 Halt Time

The Halt Timer is started when a proximity or touch event occurs and is restarted when that event is removed or reoccurs. When a proximity condition occurs on any of the channels, the LTA (Long-Term Average) value for that channel will be "halted", thus its value will be kept fixed, until the proximity event is cleared, or the halt timer reaches the halt time. The halt timer will count to the selected halt time ( $t_{\text{HALT}}$ ), which can be configured in the user selectable options (i.e.

Bank0 bit7:6), and if the timer expires, all outputs will be cleared.

It is possible that the CS (Count) value could be outside the ATI band (ATI Target  $\pm$  12.5%) when the timer expires, which will cause the device to perform a re-ATI event.

The designer needs to select a halt timer value ( $t_{\text{HALT}}$ ) to best accommodate the required application:

- **2.5 seconds** : Halt LTA for 2.5 seconds after the last proximity or touch event.
- **20 seconds** : Halt LTA for 20 seconds after the last proximity or touch event.
- **60 seconds** : Halt LTA for 60 seconds after the last proximity or touch event.
- **Never** : Never halt LTA

\* *With the 'Never' option, the detection of a proximity or touch event will not halt the LTA and the LTA will adjust towards the CS value until the CS value is reached. The touch and proximity output of a channel will thus be cleared automatically when the difference between the LTA and CS is less than the specified threshold value.*

## 6.6 Low Power Modes

The **IQS213(A)** IC has three low power modes specifically designed to reduce current consumption for battery applications.

The power modes are implemented around the occurrence of a charge cycle every  $t_{\text{SAMPLE}}$  seconds (refer to **Table 6.1**). Lower sampling frequencies typically yield significant lower power consumption (but also decreases the response time).

During normal operation charge cycles are initiated approximately every 2.6ms in the stand-alone setup and 3.9ms in the I<sup>2</sup>C debug setup. This is referred to as Normal Power Mode (NP). The **IQS213(A)** by default charges in Normal Power Mode.

While in any low power mode, only Channel 0 is active and the device will zoom to NP whenever the CS value indicates a possible proximity or touch event on CH0 (refer to **Figure 6.3**). This improves the response time. The device will remain in NP for  $t_{\text{ZOOM}}$  seconds and then return to the selected low power mode. The Zoom function allows reliable detection of events with the current samples being produced at the NP rate. Please see **Section 8.4** or refer to "**Application Note AZD079 – IQS213 Touch response rate**" for more information.

Table 6.1 : Low Power Mode Timing ( $t_{LP}$ )

| Power Mode   | $t_{SAMPLE}$<br>(Stand-alone) | $t_{SAMPLE}$<br>(I <sup>2</sup> C) |
|--------------|-------------------------------|------------------------------------|
| NP (Default) | 2.6 ms                        | 3.9ms                              |
| LP1          | 128 ms                        | 128ms                              |
| LP2          | 256 ms                        | 256ms                              |
| LP3          | 512 ms                        | 512ms                              |

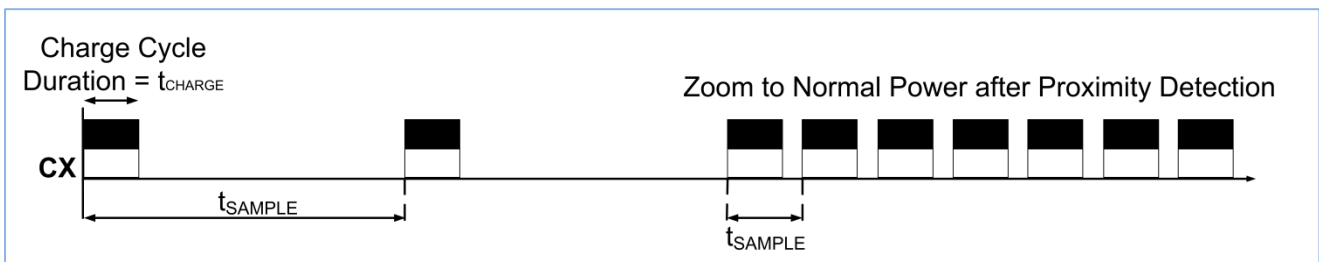

Figure 6.3 : LP Modes – Charge Cycles

## 6.7 Proximity Threshold

The **IQS213A** has 2 proximity threshold ( $P_{TH}$ ) settings. The proximity threshold is selected by the designer to obtain the desired sensitivity and noise immunity. The proximity event is triggered based on the selected proximity threshold, which is either 3 or 8 counts.

(For **IQS213**,  $P_{TH}$  is calculated by dividing the selected touch threshold value of channel 1 ( $CH1_{TTH}$ ) with the value corresponding to the  $PROX_{DIV}$  bit (i.e. either 2 or 4). The proximity threshold is expressed in terms of counts, the same as the CS value)

For proximity events, the difference between the LTA and CS (in counts) of the proximity channel should be greater than  $P_{TH}$  for at least 4 consecutive samples, unless the CS delta is greater than the touch threshold of any active channel. (See **Section 8.8**)

## 6.8 Touch Thresholds

The **IQS213(A)** has 8 touch threshold settings. The touch threshold is selected by the designer to obtain the desired touch sensitivity.

The touch event is triggered based on the selected touch threshold, which is expressed as a fraction of the LTA, given by:

$$T_{TH} = x/255 \times LTA. \text{ (See Section 8.8)}$$

For a touch event, the difference between LTA and CS (counts) of the touch channel should be greater than the selected touch threshold for at least 2 consecutive samples.

On the **IQS213(A)** device, the touch threshold settings are grouped for channels 1 and 3 ( $CH1,3_{TTH}$ ) and is separate for channel 2 ( $CH2_{TTH}$ ).

The **IQS213(A)** device is by default setup without the alternative threshold settings. The alternative threshold values can be selected by setting the  $TTH\_ALT$  bit (i.e. bit3 in Bank1).



If for specific applications the designer requires larger touch threshold values than the available selections, they may select the “3CH SWIPE – 1zz x2x zz3 (TH\*2)” IC TYPE in Bank0 of the user configurable options.

This selection is for a three channel sense electrode configuration only and will automatically multiply the threshold selections by two.

## 6.9 IQS213A (IQS213) SWIPE UI

The **IQS213(A)** has 4 selectable swipe switch user interface (UI) configurations. The swipe UI specifies the required event(s) to activate the outputs of the device:

- **Single Direction:**

The device only acknowledges swipe events in the direction of **CH1>CH2** for a 2-channel and **CH1>CH2>CH3** for a 3-channel device setup.

- **Bi-Directional:**

The device acknowledges swipe events in both the forward (**CH1>CH2>...**) and reverse (**...>CH2>CH1**) directions.

- **Directional:**

A swipe event in the forward (**CH1>CH2>...**) direction will enable the swipe output (ON) and a swipe in the reverse (**...>CH2>CH1**) direction will disable the output (OFF).

- **Dual Swipe:**

This UI requires a swipe event in one direction, followed by a swipe event in the opposite direction within 1 second, to enable the swipe output (ON). Thereafter, a single swipe in any direction will subsequently disable the swipe output again (OFF).

## 6.10 Zero States Allowed

Setting the **Zero\_State** bit in Bank2, will allow the occurrence of zero or "no touch" conditions between the different state combinations in each sequence of the selected IC type (refer to **Section 6.1** for IC types).

This grants the designer a certain degree of freedom in the selected device sensitivity and implemented sense electrode.

If for example the IC type is selected to be “**3CH SWIPE - 1zz zzz zz3**”, then the sequence ‘**1zz zzz zzz zz3**’ of state combinations will also be acknowledged as a valid swipe event.

## 6.11 End on Zero State

Setting the **Zero\_End** bit in Bank2, will append an additional zero or "no touch" state to the required sequence of state combinations.

If for example the IC type is selected to be “**3CH SWIPE - 1zz zzz zz3**”, then the sequence ‘**1zz zzz zz3 zzz**’ of state combinations will be acknowledged as a valid swipe event ONLY.

## 6.12 State Times

The minimum, maximum and overall swipe state times controls the effective period during which a successful swipe event can be recognized. The state times are defined in swipe state samples, where each sample period  $t_{STATE}$  is equal to 4 charge transfer periods. For stand-alone device operation this results in a state sample time of approximately  $t_{STATE} = 10.4ms$ .

The state time values can also be set up or changed in I<sup>2</sup>C debug mode.

### 6.12.1 Minimum State Time

The minimum state time ( $t_{MIN}$ ) defines the minimum period (in multiples of  $t_{STATE}$ ) for which each combination of states (e.g. 1zz) must be present during processing of the current sequence of the state combination.



Selecting shorter minimum state times will effectively allow faster swipe events.

### 6.12.2 Maximum State Time

The maximum state time defines the maximum period for which each combination of states (e.g. 1zz) may be present during processing of the current sequence of the state combination.

This value is fixed at  $t_{MAX} = 45 * t_{STATE}$  by default, but is accessible in I<sup>2</sup>C debug mode. Selecting longer maximum state times will effectively allow slower swipe events.

### 6.12.3 Overall State Time

The overall state time is the total allowable time for performing a swipe event and is by default set to 1 second. This value can also be changed in I<sup>2</sup>C debug mode in steps of 250ms.

## 6.13 Touch/Swipe (Pin7) Output

The IQS213(A) has one complementary output on pin 7 of the IC. This pin can be configured to output either touch events or pulses upon swipe events, after the swipe output (pin 6) has been enabled.

By default the IQS213(A) will output a logic signal for touch events on any of the three sense electrodes. If the **Pin7\_Out** bit in Bank2 is set, the device will output a short pulse for every consecutive swipe event within 2 seconds after the first swipe event.

The generated pulses have different pulse widths ( $t_{PULSE}$ ), depending on the direction of the swipe event:

- **Long Pulse:** A long pulse ( $t_{PULSE} \approx 9ms$ ) will be output for swipes in the forward (**CH1**□**CH2**...) direction.
- **Short Pulse:** A short pulse ( $t_{PULSE} \approx 3ms$ ) will be output for swipes in the reverse (...□**CH2**□**CH1**) direction.

## 6.14 AC Filter

The AC filter can be implemented to provide better stability of the proximity channel's count

(CS) measurements in electrically noisy environments by setting the **ACF** bit in Bank2.

The AC filter also enforces a longer minimum sample time for detecting proximity events, which may result in a slower response rate when the device enters low power modes.

## 6.15 ATI Method

In the stand-alone configuration the IQS213(A) is automatically set up in Full ATI to set up the device for optimal sensitivity.

In the I<sup>2</sup>C debug configuration, the IQS213(A) can be set up to start in two ways, Full ATI and Partial ATI. In Full ATI mode, the device automatically selects the multipliers through the ATI algorithm to setup the IQS213(A) as close as possible to its default sensitivity for the environment where it was placed. The designer can, however, select Partial ATI, and set the multipliers to a pre configured value. This will cause the IQS213(A) to only calculate the compensation (not the compensation and multipliers as in Full ATI), which allows the freedom to make the IQS213(A) more or less sensitive for its intended environment of use. (Please refer to **Section 8.9.**)

## 6.16 Base Value

The IQS213(A) has the option to change the base value of all channels during the ATI algorithm. Depending on the application, this provides the user with another option to select the sensitivity of the IQS213(A) without changes in the hardware (CX sizes and routing, etc). By setting the **ATI\_Base** bit in Bank3, the base value can be set to be 75 (IQS213 = 50) or 100. A lower base value will typically result in a higher sensitivity of the device. (Refer to **Section 8.9**)

## 6.17 ATI Target Value

The default target counts of the IQS213(A) are 320 for the proximity channel, and 160 for the touch channels.



However, for some applications, a more sensitive device and higher target is required. Therefore, the **ATI\_Target** bit in Bank3 can be set, changing the targets to 640 for the proximity channel, and 320 for the touch channels. (See **Section 8.9**)

## 6.18 Auto-Off / Advanced Auto-Off Warning

To prevent battery drainage in the unlikely event of a false activation of the output load, the **IQS213(A)** is equipped with an Auto-Off functionality. The Auto-Off (AAO) feature can be disabled by setting the **AAO** bit in Bank3.

### 6.18.1 Advanced Auto-Off Warning (AAOW)

In stand-alone operation the Advanced Auto-Off Warning (AAOW) timer is set for 10 minutes. After the first warning, a second warning will be given after 30s. Another 30s after the second warning, the device will switch off automatically (i.e. disable all outputs).

In I<sup>2</sup>C operation the Auto-Off (AAO) and Advanced Auto-Off Warning (AAOW) timers can be set to any value in multiples of 30s.

### 6.18.2 AAOW Clear / Reset

The AAO timer is by default cleared (reset) on a touch event on any channel. Setting the **AAO\_CLR** bit in Bank3, the AAO timer will be reset upon a proximity event.

## 6.19 I<sup>2</sup>C Debug

A streaming option is available that allows for serial data communication on the **IQS213(A)**. Data streaming is done via an I<sup>2</sup>C compatible 3-wire interface, which consist of a data (**SDA**), clock (**SCL**) and ready (**RDY**) line (for **IQS213(A)** pin-out refer to **Figure 4.1**).

The **IQS213(A)** can only function as a slave device on the bus, and will only acknowledge on address **0x44H**.

The RDY line is to be used by the host controller as an indication of when to start communication to the device. The RDY line will

be active low when it is ready for communication, and it will go high when it is doing conversions. The **IQS213(A)** will not acknowledge (ACK) on its address while the RDY line is high (i.e. while the **IQS213(A)** is doing conversions).

## 7 Additional Features

### 7.1 Noise Detection

The **IQS213(A)** has advanced integrated immunity to RF noise sources such as GSM cellular telephones, DECT, Bluetooth and WIFI devices. Design guidelines should however be followed to ensure the best noise immunity. (Please see **Section 8.10**)

#### 7.1.1 Notes for layout:

- A ground plane should be placed under the IC, except under the CX lines.
- Place the sensor IC as close as possible to the sense electrodes.
- All the tracks on the PCB must be kept as short as possible.
- The capacitor between VDDHI and GND as well as between VREG and GND must be placed as close as possible to the IC.
- A 100 pF capacitor can be placed in parallel with the 1uF capacitor between VDDHI and GND. Another 100 pF capacitor can be placed in parallel with the 1uF capacitor between VREG and GND.
- When the device is too sensitive for a specific application a parasitic capacitor (max 5pF) can be added between the CX line and ground.
- Proper sense antenna and button design principles must be followed.
- Unintentional coupling of sense antenna to ground and other circuitry must be limited by increasing the distance to these sources.





- In some instances a ground plane some distance from the device and sense antenna may provide significant shielding from undesirable interference.
  - \* However, if after proper layout, interference from an RF noise source persists, see application note **AZD015**.



## 8 ProxSense® Module

The **IQS213(A)** contains a ProxSense® module that uses patented technology to provide detection of PROX/TOUCH on numerous sensing lines.

The ProxSense® module is a combination of hardware and software, based on the principles of charge transfer measurements.

For I<sup>2</sup>C communication related data registers, please refer to the **IQS213(A)** Memory Map in **Section 10**.

### 8.1 Charge Transfer Concepts

Capacitance measurements are taken with a charge transfer process that is periodically initiated.

Self capacitance sensing measures the capacitance between the sense electrode (Cx) relative to ground.

Projected capacitance sensing measures the capacitance between 2 electrodes referred to as the transmitter (CTX) and receiver (CRX).

The measuring process is referred to as a charge transfer cycle and consists of the following:

- Discharging of an internal sampling capacitor (Cs) and the antenna capacitors (self: Cx or projected: CTX & CRX) on a channel.
- charging of Cx's / CTX's connected to the channel
- and then a series of charge transfers from the Cx's / CRX's to the internal sampling capacitors (Cs), until the trip voltage is reached.

The number of charge transfers required to reach the trip voltage on a channel is referred to as the Count or CS value.

The device continuously repeats charge transfers on the sense electrodes connected to the Cx pin. For each channel a Long Term Average (**LTA**) is calculated (12 bit unsigned integer values). The CS values (12 bit

unsigned integer values) are processed and compared to the LTA to detect Touch and Proximity events.

For more information regarding capacitive sensing, refer to the application note: "**AZD004 – Azoteq Capacitive Sensing**".

**Please note: Attaching scope probes to the Cx/CTX/CRX pins will influence the capacitance of the sense electrodes and therefore the related CS values of those channels. This will have an instant effect on the CS measurements.**

### 8.2 ProxSense® Module Setup

The **IQS213(A)** samples its channels in 4 time slots, with one internal Cs capacitor. The charge sequence is illustrated in **Fig. 8.1**.

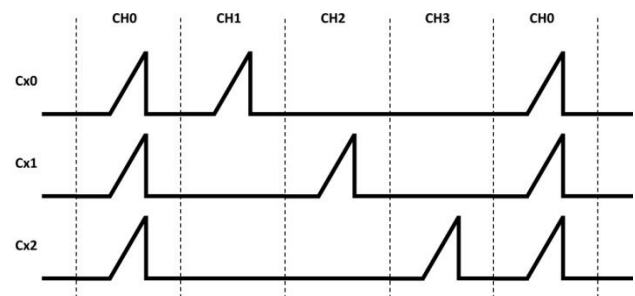

**Figure 8.1 IQS213(A) Charge Transfers**

The **IQS213(A)** charges its four channels, **CH0** (Distributed Proximity Channel) and three Touch Channels (**CH1**, **CH2** and **CH3**) independently during the four time slots. During these time slots, the non-current channels can either be grounded or set to float.

### 8.3 Self- or Projected Capacitance

The **IQS213(A)** IC can be used in either self- or projected capacitance configurations. The IC is default in a 2-channel self capacitance setup. This can be changed to a projected capacitance configuration in the user



selectable options (Bank0 bit3). The technology enabled on the IC will be reported in the SYSFLAGS register.

The **IQS213(A)** has two selectable charge transfer frequencies. For projected capacitance sense electrodes the charge frequency is by default set at  $f_{cm} = 1\text{MHz}$ , and for self capacitance configurations  $f_{cs} = 500\text{kHz}$ . Setting the **CHG\_FRQ** bit in Bank2 will double the charge frequency for both projected- and self capacitance configurations (i.e.  $f_{cm} / f_{cs} = 2\text{MHz} / 1\text{MHz}$ ).

A higher charge frequency selection is preferred for increased immunity against aqueous substances when used in most projected capacitance electrode configurations.

## 8.4 Rate of Charge Cycles

### 8.4.1 Normal Power rate

With the **IQS213(A)** in Normal Power (NP) mode, the sense channels are charged at a fixed sampling frequency ( $f_{\text{SAMPLE}}$ ) per channel. This is done to ensure regular samples for processing of results. It is calculated as each sample having a time ( $t_{\text{SAMPLE}} = \text{charge period} (t_{\text{CHARGE}}) + \text{computation time}$ ) of approximately 2.6ms, thus the time between consecutive samples on a channel ( $t_{\text{CHANNEL}}$ ) will optimally be  $t_{\text{SAMPLE}} = 4 * t_{\text{SAMPLE}} \approx 10.4\text{ms}$  (or 96Hz). The charge sequence and timings are illustrated in **Figure 8.2**.

If a channel is thus disabled, the sampling rate on the remaining channels will reduce with approximately 2.6ms.

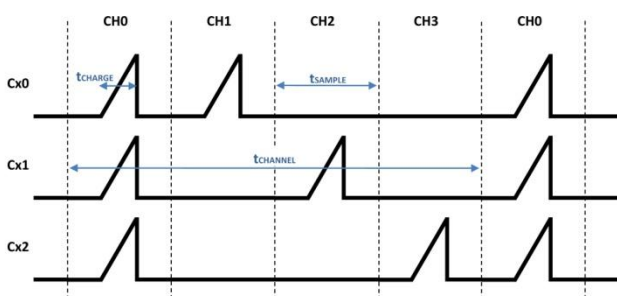

**Figure 8.2** Signals on CX's / CRX's during Normal Power Mode.

### 8.4.2 Low Power rates

Low current consumption charging modes are available. In any Low Power (LP) mode, there will be an applicable low power time ( $t_{LP}$ ). This is determined by the LP\_PERIOD register. The value written into this register multiplied by 16ms will yield the LP time ( $t_{LP}$ ).

Please note that this time is only applicable from value 03h and higher loaded into the LP\_PERIOD register. The values 01h and 02h will have a different time. See **Table 6.1** for all timings.

With the detection of an undebounced proximity event the IC will zoom to NP mode, allowing a very fast reaction time for further possible touch / proximity events. All active channels will be consecutively charged every  $T_{LP}$ .

If a LP rate is selected through register LP\_Period and charging is not in the zoomed in state (NP mode), the LP\_Active bit (SYSFLAGS register) will be set.

## 8.5 Touch Report Rate

During Normal Mode operation, the touch report rate of the **IQS213** device depends on the charge transfer frequency, the number of channels enabled and the length of communications performed by the master device.

### 8.6 Active channels

The user has the option to enable the third channel (CH3) during I<sup>2</sup>C operation. This can be done in the SWIPE\_SETTINGS register (SET\_3CH bit). Only two channels (CH1 and CH2) are default enabled.

Note: During Low Power (LP) modes only CH0 is active.



## 8.7 Long Term Average (LTA)

The LTA filter can be seen as the baseline or reference value. The LTA is calculated to continuously adapt to any environmental drift. The LTA filter is calculated from the CS value for each channel. The LTA filter allows the device to adapt to environmental (slow moving) changes/drift. Actuation (Touch or Prox) decisions are made by comparing the CS value with the LTA reference value.

The 12bit LTA value is contained in the LTA\_H and LTA\_L registers.

Please refer to Section 6.5 for LTA Halt Times.

## 8.8 Determine Touch or Prox

An event is determined by comparing the CS with the LTA. Since the CS reacts differently when comparing the self- with the projected capacitance technology, the user should consider only the conditions for the technology used.

An event is recorded if:

- Self: CS < LTA – **Threshold**
- Projected: CS > LTA + **Threshold**

**Threshold** can be either a Proximity or Touch threshold, depending on the current channel being processed.

Please refer to **Section 6.7** and **6.8** for proximity and touch threshold selections.

## 8.9 ATI

The **Automatic Tuning Implementation (ATI)** is a sophisticated technology implemented on the new ProxSense® series devices. It allows for optimal performance of the devices for a wide range of sense electrode capacitances, without modification or addition of external components.

The ATI allows the tuning of two parameters, an ATI Multiplier and an ATI Compensation, to adjust the sample value for an attached sensing antenna.

ATI allows the designer to optimize a specific design by adjusting the sensitivity and stability of each channel through the adjustment of the ATI parameters.

The **IQS213(A)** has an automated ATI function. The auto-ATI function is default enabled, but can be disabled by setting the ATI\_OFF and ATI\_Partial bits in the PROX\_SETTINGS registers.

The ATI\_Busy bit in the SYSFLAGS register will be set while an ATI event is busy.

### 8.9.1 ATI Sensitivity

In I<sup>2</sup>C mode, the designer can specify the global BASE value for all channels and the TARGET values for the proximity (CH0) and touch (CH1,CH2,CH3) channels. A rough estimation of sensitivity can be calculated as:

$$Sensitivity = \frac{TARGET}{BASE}$$

As can be seen from this equation, the sensitivity can be increased by either increasing the Target value or decreasing the Base value. It should, however, be noted that a higher sensitivity will yield a higher noise susceptibility.

### 8.9.2 ATI Target

The target is reached by adjusting the COMPENSATION bits for each channel.

The target value is written into the respective channel's TARGET registers. The value written into these registers multiplied by 8 will yield the new target value.

### 8.9.3 ATI Base (MULTIPLIER)

The following parameters will influence the base value:

- CS\_SIZE<sup>i</sup>: Size of sampling capacitor.
- PROJ\_BIAS bits: Adjusts the biasing of some analogue parameters in the projected

<sup>i</sup> Changing CS\_SIZE if ATI\_OFF = 0 will change CS



capacitive operated IC. (Only applicable in projected capacitance mode.)

- MULTIPLIER bits.

The base value used for the ATI function can be implemented in 2 ways:

1. ATI\_PARTIAL = 0. ATI automatically adjusts MULTIPLIER bits to reach a selected base value<sup>ii</sup>. Base values are available in the BASE\_VALUE register.
2. ATI\_PARTIAL = 1. The designer can specify the multiplier settings. These settings will give a custom base value from where the compensation bits will be automatically implemented to reach the required target value.

#### 8.9.4 Re-ATI

An automatic re-ATI event will occur if the CS is outside its re-ATI limits. The re-ATI limit is calculated as the target value divided by 8. For example:

Target = 320

Re-ATI will occur if CS is outside 320±40.

During I<sup>2</sup>C operation, a re-ATI event can also be issued by the master by setting the REDO\_ATI bit. It will clear automatically after the ATI event was started.

## 8.10 RF Detection

In cases of extreme RF interference, the on-chip RF detection is suggested. This detector can be enabled by setting the Noise\_Detect bit in the PROX\_SETTINGS1 register. By connecting a suitable antenna to the RF pin, it allows the device to detect RF noise and notify the master of possible corrupt data.

Noise affected samples are not allowed to influence the LTA filter, and also do not contribute to proximity or touch detection. With

the detection of noise, the NOISE\_FOUND bit in SYSFLAGS will be set.

### 8.10.1 RF detector sensitivity

The sensitivity of the RF detector can be selected by setting an appropriate RF detection voltage through the RF\_TRIM bits. Please see application note **AZD015** for further details regarding this option.

---

<sup>ii</sup> ATI function will use user selected CS\_SIZE and PROJ\_BIAS (if applicable) and will only adjust the MULTIPLIER bits to reach the base values.



## 9 Communication

The **IQS213(A)** can communicate on the I<sup>2</sup>C compatible bus structure. It uses a 3-wire serial interface bus which is I<sup>2</sup>C compatible and comprise of a data (**SDA**), clock (**SCL**) and optional ready (**RDY**) line (for **IQS213(A)** pin-out refer to **Figure 4.1**).

The **IQS213(A)** has one available I<sup>2</sup>C address, **I<sup>2</sup>C address = 0x44H**.

The maximum I<sup>2</sup>C compatible communication speed for the **IQS213(A)** is 400kbit/s.

### 9.1 Event Mode

The **IQS213(A)** will by default be configured to only communicate with the master if a change in an event occurs. For this reason, it would be highly recommended to use the RDY line when communicating with the **IQS213(A)**, especially in Low Power (LP) modes. These communication requests are referred to as Event Mode triggering (only changes in events are reported).

Event mode can be disabled by setting the **EVENT\_MODE\_OFF** bit.

The events responsible for resuming communication can be chosen through the **EVENT\_MASK** register. By default all events are enabled.

The device can also communicate on polling basis, using only the SDA and SCL lines.

### 9.2 I<sup>2</sup>C Specific commands

#### 9.2.1 IC Reset indication

**SHOW\_RESET** can be read to determine whether a reset occurred on the device. This bit will be a '1' after a reset. The value of **SHOW\_RESET** can be cleared to '0' by writing a '1' in the **ACK\_RESET** bit.

#### 9.2.2 WDT

The WDT is used to reset the IC if a problem (for example a voltage spike) occurs during

communication. The WDT will time-out after  $t_{WDT}$ , if no valid communication occurs for this time.

### 9.3 I<sup>2</sup>C Read and Write specifics

For more details, please refer to the **IQS213** Memory Map (**Section 10**) for device memory register descriptions and application note: "**AZD066: IQS213 Communication Interface Guideline**" document available at: [www.azoteq.com](http://www.azoteq.com).



## 10 IQS213A (IQS213) Memory Map

### 10.1 Memory Registers

**Table 10.1 : IQS213(A) Memory Registers**

| Register Address | Register Name         | Description                                    |                      |
|------------------|-----------------------|--|----------------------|
| 00H              | Product Number        | 'D43' / '2BH'                                  | Device Information   |
| 01H              | Version Number        | '02' (IQS213 = '01')                           |                      |
| 10H              | Sys_flags0            | System Flags - <b>See Table 10.2</b>           | Device Specific Data |
| 11H              | Swipe Flags           | Swipe Switch Flags - <b>See Table 10.2</b>     |                      |
| 35H              | Touch CHs             | Channels Touched - <b>See Table 10.2</b>       | Count Data           |
| 3DH              | Chan_num              | Number of Currently Processed Channel          |                      |
| 42H              | CS High               | Count (CS) value [high byte]                   |                      |
| 43H              | CS Low                | Count (CS) value [low byte]                    |                      |
| 83H              | LTA High              | Long Term Average [high byte]                  |                      |
| 84H              | LTA Low               | Long Term Average [low byte]                   |                      |
| C4H              | Current Sate          | Swipe Engine Current State                     |                      |
| C5H              | Measured State        | Current Measured State (Acc. to Touches)       |                      |
| C6H              | Next State            | Swipe Engine Next Expected State               |                      |
| C7H              | Swipe States          | Combination of States Required for Swipe       |                      |
| C8H              | Swipe Min Timer       | Minimum timer counts – swipe periods           |                      |
| C9H              | Swipe Max Timer       | Maximum Overall timer – 250ms periods          |                      |
| CAH              | Swipe Max State Timer | Maximum Per State timer – swipe periods        |                      |
| CBH              | Swipe Settings        | <b>IQS213 Set Up - See Table 10.2</b>          | Device Settings      |
| CCH              | Prox Settings 0       | <b>IQS213 Set Up - See Table 10.2</b>          |                      |
| CDH              | Prox Settings 1       | <b>IQS213 Set Up - See Table 10.2</b>          |                      |
| CEH              | Prox Settings 2       | <b>IQS213 Set Up - See Table 10.2</b>          |                      |
| CFH              | ATI Target CH0        | (Target CH0) *8 = Channel 0 Target Value       |                      |
| D0H              | ATI Target CH1-CH3    | (Target CH1-CH3) *8 = Channel 1-3 Target Value |                      |
| D1H              | Prox Threshold        | Proximity Threshold Value (In Counts)          |                      |
| D2H              | Touch Threshold 1     | Channel 1 Touch Threshold [In Counts]          |                      |



| Register Address | Register Name       | Description   |                 |
|------------------|---------------------|---|-----------------|
| D3H              | Touch Threshold 2   | Channel 2 Touch Threshold [In Counts]                         | Device Settings |
| D4H              | Touch Threshold 3   | Channel 3 Touch Threshold [In Counts]                         |                 |
| D5H              | Base Value          | ATI Base Value [0-256 - In Counts]                            |                 |
| D6H              | Event Mask          | Events Allowed - <b>See Table 10.2</b>                        |                 |
| D7H              | Mirror_CH0          | Mirror – lower 6 bits – NN PPP                                |                 |
| D8H              | Mirror_CH1          | Mirror – lower 6 bits – NN PPP                                |                 |
| D9H              | Mirror_CH2          | Mirror – lower 6 bits – NN PPP                                |                 |
| DAH              | Mirror_CH3          | Mirror – lower 6 bits – NN PPP                                |                 |
| DBH              | PCC0                | CH0 Compensation  |                 |
| DCH              | PCC1                | CH1 Compensation  |                 |
| DDH              | PCC2                | CH2 Compensation  |                 |
| DEH              | PCC3                | CH3 Compensation  |                 |
| DFH              | AAOW Timer          | (AAOW Timer)*30s = Auto-Off Warning time                      | Device Settings |
| E0H              | AO Timer            | (AO Timer)*30s = Auto-Off time                                |                 |
| E1H              | Swipe Min Samples   | Set minimum samples per state [x+1]                           |                 |
| E2H              | Swipe Max Samples   | Set maximum samples per state [x+1]                           |                 |
| E3H              | Swipe Overall Limit | Set Overall Swipe Length Limit [*250ms]                       |                 |
| E4H              | LP Period           | (LP Period)*16ms = Low Power Charge Timing (t <sub>LP</sub> ) |                 |
| E5H              | Touch States 0      | Swipe Engine Configuration                                    |                 |
| E6H              | Touch States 1      | Swipe Engine Configuration                                    |                 |
| E7H              | Touch States 2      | Swipe Engine Configuration                                    |                 |
| E8H              | Touch States 3      | Swipe Engine Configuration                                    |                 |
| E9H              | Touch States 4      | Swipe Engine Configuration                                    |                 |
| EAH              | Touch States 5      | Swipe Engine Configuration                                    |                 |
| EBH              | Touch States6       | Swipe Engine Configuration                                    |                 |
| ECH              | Touch States 7      | Swipe Engine Configuration                                    |                 |
| EDH              | Default Comms       | Default Comms pointer   |                 |





Table 10.2 : IQS213(A) Memory Register bits

|                        | bit7             | bit6           | bit5           | bit4               | bit3            | bit2         | bit1           | bit0             |
|------------------------|------------------|----------------|----------------|--------------------|-----------------|--------------|----------------|------------------|
| <b>Prox Settings 0</b> | Show Reset       | ACK Reset      | Reseed         | Redo ATI           | ATI Partial     | Float CX     | THALT1         | THALT0           |
| <b>Prox Settings 1</b> | Comms WDT OFF    | Event Mode OFF | Debug I2C      | AO Clear Prox      | AO OFF          | ACF OFF      | ATI OFF        | Noise Detect OFF |
| <b>Prox Settings 2</b> |                  |                |                |                    | IO_OUT          | CS_Cap       | Proj_B1        | Proj_B0          |
| <b>Swipe Settings</b>  | Set_3CH          | Touches/Pulses | Swipe UI       | Swipe UI           | End_Zero        | Zero_State   | States Relaxed | Swipe Active     |
| <b>Swipe Flags</b>     | Swipe Pulse Flag | Time Out Flag  | Slide Occurred | DualSwipe Active   | Swipe Direction | AO Triggered | Final State    | Start State      |
| <b>Event Mask</b>      |                  |                |                | Noise Event        | ATI Event       | Swipe Event  | Touch Event    | Prox Event       |
| <b>Sys_flags0</b>      | System Use       | LP Active      | Active High    | Projected CapSense | Filter Halt     | ATI Busy     | Noise Found    | Zoom             |
| <b>Touch CHs</b>       | Swipe Output     |                |                |                    | CH3             | CH2          | CH1            | CH0/Prox         |

## 10.2 Memory Registers Description

### 10.2.1 Device Information

| 00H    |       | Product Number (Prod_NR) |   |   |   |   |   |   |   |
|--------|-------|--------------------------|---|---|---|---|---|---|---|
| Access | Bit   | 7                        | 6 | 5 | 4 | 3 | 2 | 1 | 0 |
| R      | Value | 43 (Decimal)             |   |   |   |   |   |   |   |

| 01H    |       | Version Number (Ver_NR) |   |   |   |   |   |   |   |
|--------|-------|-------------------------|---|---|---|---|---|---|---|
| Access | Bit   | 7                       | 6 | 5 | 4 | 3 | 2 | 1 | 0 |
| R      | Value | Ver_NR                  |   |   |   |   |   |   |   |

- **[00H] PROD\_NR :** The product number for the IQS213(A) is 43 (decimal).
- **[01H] VER\_NR :** Device ROM software version number can be read in this byte.



## 10.2.2 Device Specific Data

| 10H    |      | System Flags (Sys_flags0) |           |             |                    |             |          |             |      |
|--------|------|---------------------------|-----------|-------------|--------------------|-------------|----------|-------------|------|
| Access | Bit  | 7                         | 6         | 5           | 4                  | 3           | 2        | 1           | 0    |
| R      | Name | System Use                | LP Active | Active High | Projected CapSense | Filter Halt | ATI Busy | Noise Found | Zoom |

- **[10H] Sys\_flags0:**
  - bit7: System Use
  - bit6: LP Active – Indicates if device is in a Low Power Mode.
  - bit5: Active High – Bit is set if Output Logic is Active High.
  - bit4: Projected CapSense – Bit is set if Projected Capacitance technology is used.
  - bit3: Filter Halt – Indicates if LTA filters are halted.
  - bit2: ATI Busy – Indicates if ATI algorithm is being performed.
  - bit1: Noise Found – Bit is set if RF noise is detected. (RF Detection must be enabled)
  - bit0: Zoom – Indicates if device is zoomed to Normal Power.

| 11H    |      | Swipe Switch Flags (Swipe Flags) |               |                |                  |                 |              |             |             |
|--------|------|----------------------------------|---------------|----------------|------------------|-----------------|--------------|-------------|-------------|
| Access | Bit  | 7                                | 6             | 5              | 4                | 3               | 2            | 1           | 0           |
| R/W    | Name | Swipe Pulse Flag                 | Time Out Flag | Slide Occurred | DualSwipe Active | Swipe Direction | AO Triggered | Final State | Start State |

- **[11H] Swipe Flags:**
  - bit7: Swipe Pulse Flag – Bit is set if Pin7 Output = Pulses
  - bit6: Time Out Flag – Bit is set if Max State Timer is exceeded.
  - bit5: Slide Occurred – Bit is set if Swipe event has occurred.  
**(Note: Bit must be cleared manually)**
  - bit4: DualSwipe Active – Bit is set if Swipe UI = Dual Swipe.
  - bit3: Swipe Direction – 0 = Forward direction, 1 = Reverse direction.
  - bit2: AO Triggered – Bit is set if Auto-Off Warning has been set.
  - bit1: Final State – Bit is set if Swipe Engine is in Final State.
  - bit0: Start State – Bit is set if Swipe Engine is in Start State.



### 10.2.3 Current Sample (CS) or Count Data

| 35H    |      | Touch/Output Data (Touch CHs) |   |   |   |     |     |     |          |
|--------|------|-------------------------------|---|---|---|-----|-----|-----|----------|
| Access | Bit  | 7                             | 6 | 5 | 4 | 3   | 2   | 1   | 0        |
| R      | Name | Swipe Output                  |   |   |   | CH3 | CH2 | CH1 | CH0/Prox |

- **[35H] Touch CHs:**
  - bit7: Swipe Output – Bit is toggled on Swipe Events. (**Note:** This bit corresponds to the IC swipe output (Pin6) and is UI dependent.)
  - bit6: Not used.
  - bit5: Not used.
  - bit4: Not used.
  - bit3: CH3 – Bit is set if a Touch is present on this channel.
  - bit2: CH2 – Bit is set if a Touch is present on this channel.
  - bit1: CH1 – Bit is set if a Touch is present on this channel.
  - bit0: CH0/Prox – Bit is set if a Proximity Event is present.

| 3DH    |      | Channel Number (Chan_num)             |   |   |   |   |   |   |   |
|--------|------|---------------------------------------|---|---|---|---|---|---|---|
| Access | Bit  | 7                                     | 6 | 5 | 4 | 3 | 2 | 1 | 0 |
| R      | Name | Variable: Value between 0x00 and 0x03 |   |   |   |   |   |   |   |

- **[3DH] Chan\_num:** bit7:0: The Chan\_Num byte indicates which channel's data is currently available in the CS and LTA bytes:
  - 0 = Ch0 (Distributed PROX channel)
  - 1 = Ch1 (CRX0)
  - 2 = Ch2 (CRX1)
  - 3 = Ch3 (CRX2)



|        |       |                                      |   |   |   |   |   |   |   |
|--------|-------|--------------------------------------|---|---|---|---|---|---|---|
| 42H    |       | Count (CS) Value High byte (CS High) |   |   |   |   |   |   |   |
| Access | Bit   | 7                                    | 6 | 5 | 4 | 3 | 2 | 1 | 0 |
| R      | Value | Variable (High byte)                 |   |   |   |   |   |   |   |

- **[42H] CS High:** bit7:0: Count (CS) Value High Byte of currently processed channel. (See Channel Number.)

|        |       |                                    |   |   |   |   |   |   |   |
|--------|-------|------------------------------------|---|---|---|---|---|---|---|
| 43H    |       | Count (CS) Value Low byte (CS Low) |   |   |   |   |   |   |   |
| Access | Bit   | 7                                  | 6 | 5 | 4 | 3 | 2 | 1 | 0 |
| R      | Value | Variable (Low byte)                |   |   |   |   |   |   |   |

- **[43H] CS Low:** bit7:0: Count (CS) Value Low Byte of currently processed channel. (See Channel Number.)

|        |       |  |   |   |   |   |   |   |   |
|--------|-------|--|---|---|---|---|---|---|---|
| 83H    |       | Long Term Average High byte (LTA High) |   |   |   |   |   |   |   |
| Access | Bit   | 7                                      | 6 | 5 | 4 | 3 | 2 | 1 | 0 |
| R      | Value | Variable (High byte)                   |   |   |   |   |   |   |   |

- **[83H] LTA High:** bit7:0: Long Term Average (LTA) value High Byte of currently processed channel. (See Channel Number.)

|        |       |                                      |   |   |   |   |   |   |   |
|--------|-------|--------------------------------------|---|---|---|---|---|---|---|
| 84H    |       | Long Term Average Low byte (LTA Low) |   |   |   |   |   |   |   |
| Access | Bit   | 7                                    | 6 | 5 | 4 | 3 | 2 | 1 | 0 |
| R      | Value | Variable (Low byte)                  |   |   |   |   |   |   |   |

- **[84H] LTA Low:** bit7:0: Long Term Average (LTA) value Low Byte of currently processed channel. (See Channel Number.)



## 10.2.4 Device Settings

| CBH    |      | SwipeSwitch Settings (Swipe Settings) |                |           |           |          |            |                |              |
|--------|------|---------------------------------------|----------------|-----------|-----------|----------|------------|----------------|--------------|
| Access | Bit  | 7                                     | 6              | 5         | 4         | 3        | 2          | 1              | 0            |
| R/W    | Name | Set_3CH                               | Touches/Pulses | Swipe UI1 | Swipe UI0 | End_Zero | Zero_State | States Relaxed | Swipe Active |

- **[CBH] Swipe Settings:**

- bit7: Set\_3CH – R/W bit. Set bit to enable 3<sup>rd</sup> channel (CRX2).
- bit6: Touches/Pulses – Bit indicates/set output on IC pin 7.
- bit5:4: Swipe UI – Bits indicate/set selected swipe user interface (UI).
- bit3: End\_Zero – R/W bit. (See **Section 6.11**)
- bit2: Zero\_State – R/W bit. (See **Section 6.10**)
- bit1: States Relaxed – R/W bit. (See **Section 6.1**)
- bit0: Swipe Active – Bit indicates/set selection of Swipe/Normal Mode IC TYPE. (See **Section 6.1**)

| CCH    |      | ProxSense® Module Settings 0 (Prox Settings 0) |           |        |          |             |          |        |        |
|--------|------|--|-----------|--------|----------|-------------|----------|--------|--------|
| Access | Bit  | 7  | 6         | 5      | 4        | 3           | 2        | 1      | 0      |
| R/W    | Name | Show Reset                                     | ACK Reset | Reseed | Redo ATI | ATI Partial | Float CX | THALT1 | THALT0 |

- **[CCH] Prox Settings 0:**

- bit7: Show Reset – Bit is set if device was reset.
- bit6: ACK Reset – Set bit to acknowledge device reset (Setting this bit will clear Show Reset bit).
- bit5: Reseed – Set bit to reseed LTA filter values.
- bit4: Redo ATI – Set bit to perform ATI algorithm.
- bit3: ATI Partial – R/W bit. (See **Section 8.9**)
- bit2: Float CX – R/W bit. (See **Section 6.3**)
- bit1:0: THALT1:THALT0 – Bits indicate/set LTA halt period. (See **Section 6.5**)



| CDH    |      | ProxSense® Module Settings 1 (Prox Settings 1) |                |           |               |        |         |         |                  |
|--------|------|--|----------------|-----------|---------------|--------|---------|---------|------------------|
| Access | Bit  | 7  | 6              | 5         | 4             | 3      | 2       | 1       | 0                |
| R/W    | Name | Comms WDT OFF                                  | Event Mode OFF | Debug I2C | AO Clear Prox | AO OFF | ACF OFF | ATI OFF | Noise Detect OFF |

▪ **[CDH] Prox Settings 1:**

- bit7: Comms WDT OFF – R/W bit. (See **Section 9.2**)
- bit6: Event Mode OFF – Set bit to disable Event Mode I<sup>2</sup>C.
- bit5: Debug I<sup>2</sup>C – Bit is set during I<sup>2</sup>C operation. (Do not clear)
- bit4: AO Clear Prox – Set bit to clear Auto-OFF timer on Prox.
- bit3: AO OFF – Set bit to disable Auto-OFF function.
- bit2: ACF OFF – Bit is set if AC Filter is Disabled. (R/W)
- bit1: ATI OFF – Set bit to disable Auto-ATI functionality. (See **Section 8.9**)
- bit0: Noise Detect OFF – Set bit to disable RF detection.

| CEH    |      | ProxSense® Module Settings 2 (Prox Settings 2) |   |   |   |        |        |         |         |
|--------|------|--|---|---|---|--------|--------|---------|---------|
| Access | Bit  | 7  | 6 | 5 | 4 | 3      | 2      | 1       | 0       |
| R/W    | Name |  |   |   |   | IO_OUT | CS_Cap | Proj_B1 | Proj_B0 |

▪ **[CEH] Prox Settings 2:**

- bit7: Not used.
- bit6: Not used.
- bit5: Not used.
- bit4: Not used.
- bit3: IO\_OUT – Set bit to enable/disable additional output on PO/TX pin (IC pin 10) during I<sup>2</sup>C operation.
- bit2: \*CS\_Cap – R/W bit for selection of Internal Reference Capacitor size. (0 =29.9pF; 1= 59.8pF)
- bit1:0 \*Proj\_B1:Proj\_B0 – R/W bits for selection of internal bias current for projected capacitance configurations.

**\*Please Note:** It is **not recommended** to adjust the settings of the internal reference capacitor (Cs) and bias current (i.e. bit2:0) of the *ProxSense® Module Settings 2* register.



| D6H    |      | I <sup>2</sup> C Debug – Event Mode Event Mask (Event Mask) |   |   |             |           |             |             |            |
|--------|------|---|---|---|-------------|-----------|-------------|-------------|------------|
| Access | Bit  | 7   | 6 | 5 | 4           | 3         | 2           | 1           | 0          |
| R/W    | Name |   |   |   | Noise Event | ATI Event | Swipe Event | Touch Event | Prox Event |

- **[D6H] Event Mask:**
  - bit7: Not used.
  - bit6: Not used.
  - bit5: Not used.
  - bit4: Noise Event – Set bit to mask RF Noise events during Event Mode I<sup>2</sup>C comms. (Requires RF-detection = Enabled.)
  - bit3: ATI Event – Set bit to mask ATI events during Event Mode I<sup>2</sup>C comms.
  - bit2: Swipe Event – Set bit to mask Swipe events during Event Mode I<sup>2</sup>C comms.
  - bit1: Touch Event – Set bit to mask Touch events during Event Mode I<sup>2</sup>C comms.
  - bit0: Prox Event – Set bit to mask Proximity events during Event Mode I<sup>2</sup>C comms.



## 11 Electrical Specifications – All Preliminary

### 11.1 Absolute Maximum Specifications

**Note:** Exceeding these maximum specifications may cause damage to the device.

|  |                   |
|--|-------------------|
| Operating temperature                      | -40°C to 85°C     |
| Supply Voltage ( $V_{DDHI} - V_{SS}$ )     | 3.6V              |
| Maximum pin voltage                        | $V_{DDHI} + 0.5V$ |
| Maximum continuous current (specific pins) | 2mA               |
| Pin voltage (Cx)                           | $V_{REG}$         |
| Minimum pin voltage                        | $V_{SS} - 0.5V$   |
| Minimum power-on slope                     | 100V/s            |
| ESD protection (Human Body Model)          | ±4kV              |
| Maximum pin temperature during soldering   | 350°C (5 seconds) |
| Maximum load capacitance – Cx to GND       | 100pF             |
| Maximum Rx-Tx Mutual capacitance (Cm)      | 9pF               |

### 11.2 General Characteristics (Measured at 25°C)

Table 11.1 IQS213(A) General Operating Conditions (a)

| DESCRIPTION  | Conditions                     | PARAMETER          | MIN  | TYP         | MAX  | UNIT |
|--|--------------------------------|--------------------|------|-------------|------|------|
| Supply voltage   |                                | $V_{DDHI}$         | 1.80 | <b>3.30</b> | 3.60 | V    |
| Internal regulator output  | $1.80 \leq V_{DDHI} \leq 3.60$ | $V_{REG}$          | 1.63 | <b>1.70</b> | 1.77 | V    |
| Normal Power operating current <sup>1</sup><br>$t_{LP} = N/A$<br>$1.80 \leq V_{DDHI} \leq 3.60$  | 2CH Self                       | $I_{IQS213A\_NP}$  | 145  | <b>175</b>  | 210  | μA   |
|  | 3CH Self                       |                    | 150  | <b>180</b>  | 215  | μA   |
| Low power 1 operating current <sup>1</sup><br>$t_{LP} = 128ms$<br>$1.80 \leq V_{DDHI} \leq 3.60$ | 2CH Self                       | $I_{IQS213A\_LP1}$ | 3.85 | <b>4.65</b> | 5.65 | μA   |
|  | 3CH Self                       |                    | 3.90 | <b>4.70</b> | 5.70 | μA   |
| Low power 2 operating current <sup>1</sup><br>$t_{LP} = 256ms$<br>$1.80 \leq V_{DDHI} \leq 3.60$ | 2CH Self                       | $I_{IQS213A\_LP2}$ | 2.50 | <b>3.00</b> | 3.60 | μA   |
|  | 3CH Self                       |                    | 2.55 | <b>3.10</b> | 3.65 | μA   |
| Low power 3 operating current <sup>1</sup><br>$t_{LP} = 512ms$<br>$1.80 \leq V_{DDHI} \leq 3.60$ | 2CH Self                       | $I_{IQS213A\_LP3}$ | 1.75 | <b>2.10</b> | 2.65 | μA   |
|  | 3CH Self                       |                    | 1.80 | <b>2.20</b> | 2.75 | μA   |

1. CHG FRQ = 500kHz, ATI Target = 320/160, Normal Touch IC, Stand-Alone, Active High Output. Altering the projected current bias settings, reference capacitor (CS) size, number of active channels and ATI Target values will affect the measured current.





Table 11.2 IQS213(A) Current Consumption (b)

| DESCRIPTION   | Conditions | PARAMETER          | MIN  | TYP         | MAX  | UNIT    |
|---|------------|--------------------|------|-------------|------|---------|
| Normal Power operating current <sup>2</sup><br>$t_{LP} = N/A$<br>$1.80 \leq V_{DDHI} \leq 3.60$ | 2CH Self   | $I_{IQS213A\_NP}$  | 150  | <b>180</b>  | 210  | $\mu A$ |
|   | 3CH Self   |                    | 150  | <b>185</b>  | 215  | $\mu A$ |
| Low power 1 operating current <sup>2</sup><br>$t_{LP} = 128ms$                                  | 2CH Self   | $I_{IQS213A\_LP1}$ | 4.35 | <b>4.90</b> | 5.75 | $\mu A$ |
|   | 3CH Self   |                    | 4.40 | <b>4.95</b> | 5.80 | $\mu A$ |
| Low power 2 operating current <sup>2</sup><br>$t_{LP} = 256ms$                                  | 2CH Self   | $I_{IQS213A\_LP2}$ | 2.85 | <b>3.45</b> | 4.10 | $\mu A$ |
|   | 3CH Self   |                    | 2.90 | <b>3.50</b> | 4.15 | $\mu A$ |
| Low power 3 operating current <sup>2</sup><br>$t_{LP} = 512ms$                                  | 2CH Self   | $I_{IQS213A\_LP3}$ | 2.15 | <b>2.60</b> | 3.15 | $\mu A$ |
|   | 3CH Self   |                    | 2.25 | <b>2.70</b> | 3.25 | $\mu A$ |

2. CHG FRQ = 500kHz, ATI Target = 320/160, Event-Mode I2C, 10k Pull-Up's. Altering the projected current bias settings, reference capacitor (CS) size, number of active channels and ATI Target values will affect the measured current.

Table 11.3 IQS213(A) Current Consumption (c)

| DESCRIPTION   | Conditions    | PARAMETER          | MIN  | TYP         | MAX  | UNIT    |
|---|---------------|--------------------|------|-------------|------|---------|
| Normal Power operating current <sup>3</sup><br>$t_{LP} = N/A$<br>$1.80 \leq V_{DDHI} \leq 3.60$ | 2CH Projected | $I_{IQS213A\_NP}$  |      | <b>230</b>  | 250  | $\mu A$ |
|   | 3CH Projected |                    |      | <b>235</b>  | 250  | $\mu A$ |
| Low power 1 operating current <sup>3</sup><br>$t_{LP} = 128ms$                                  | 2CH Projected | $I_{IQS213A\_LP1}$ | 4.30 | <b>5.10</b> | 5.90 | $\mu A$ |
|   | 3CH Projected |                    | 4.35 | <b>5.15</b> | 6.00 | $\mu A$ |
| Low power 2 operating current <sup>3</sup><br>$t_{LP} = 256ms$                                  | 2CH Projected | $I_{IQS213A\_LP2}$ | 2.65 | <b>3.20</b> | 3.80 | $\mu A$ |
|   | 3CH Projected |                    | 2.70 | <b>3.25</b> | 3.90 | $\mu A$ |
| Low power 3 operating current <sup>3</sup><br>$t_{LP} = 512ms$                                  | 2CH Projected | $I_{IQS213A\_LP3}$ | 1.85 | <b>2.25</b> | 2.70 | $\mu A$ |
|   | 3CH Projected |                    | 1.90 | <b>2.30</b> | 2.75 | $\mu A$ |

3. CHG FRQ = 2MHz, ATI Target = 320/160, Stand-Alone, Active High Output. Altering the projected current bias settings, reference capacitor (CS) size, number of active channels and ATI Target values will affect the measured current.

Table 11.4 IQS213(A) Current Consumption (d)

| DESCRIPTION   | Conditions    | PARAMETER          | MIN  | TYP         | MAX  | UNIT    |
|---|---------------|--------------------|------|-------------|------|---------|
| Normal Power operating current <sup>4</sup><br>$t_{LP} = N/A$<br>$1.80 \leq V_{DDHI} \leq 3.60$ | 2CH Projected | $I_{IQS213A\_NP}$  |      | <b>230</b>  | 250  | $\mu A$ |
|   | 3CH Projected |                    |      | <b>235</b>  | 260  | $\mu A$ |
| Low power 1 operating current <sup>4</sup><br>$t_{LP} = 128ms$                                  | 2CH Projected | $I_{IQS213A\_LP1}$ | 5.45 | <b>6.35</b> | 7.50 | $\mu A$ |
|   | 3CH Projected |                    | 5.60 | <b>6.50</b> | 7.60 | $\mu A$ |
| Low power 2 operating current <sup>4</sup><br>$t_{LP} = 256ms$                                  | 2CH Projected | $I_{IQS213A\_LP2}$ | 3.30 | <b>3.95</b> | 4.65 | $\mu A$ |
|   | 3CH Projected |                    | 3.40 | <b>4.00</b> | 4.75 | $\mu A$ |
| Low power 3 operating current <sup>4</sup><br>$t_{LP} = 512ms$                                  | 2CH Projected | $I_{IQS213A\_LP3}$ | 2.40 | <b>2.90</b> | 3.40 | $\mu A$ |
|   | 3CH Projected |                    | 2.50 | <b>3.00</b> | 3.45 | $\mu A$ |

4. CHG FRQ = 2MHz, ATI Target = 640/320, Event-Mode I2C, 10k Pull-Up's. Altering the projected current bias settings, reference capacitor (CS) size, number of active channels and ATI Target values will affect the measured current.



**Table 11.5 Start-up and shut-down slope Characteristics**

| DESCRIPTION | Conditions                     | PARAMETER | MIN | MAX  | UNIT |
|-------------|--------------------------------|-----------|-----|------|------|
| POR         | $V_{DDHI}$ Slope $\geq 100V/s$ | POR       | 1   | 1.55 | V    |
| BOD         |                                | BOD       | 1   | 1.5  | V    |

**Table 11.6 Debounce employed on IQS213(A)**

| DESCRIPTION              | Conditions      | Debounce Value  |
|--------------------------|-----------------|-----------------|
| Proximity debounce value | Proximity event | 4 (Up and Down) |
| Touch debounce value     | Touch event     | 2 (Up and Down) |

## 11.3 Timing Characteristics

**Table 11.7 Main Oscillator<sup>1</sup>**

| SYMBOL    | DESCRIPTION               | Conditions                     | MIN | TYP | MAX | UNIT |
|-----------|---------------------------|--------------------------------|-----|-----|-----|------|
| $F_{OSC}$ | IQS213(A) Main oscillator | $1.80 \leq V_{DDHI} \leq 3.60$ |     | 4   |     | MHz  |

1. All timings derived from Main Oscillator

**Table 11.8 General Timing Characteristics for  $1.80V \leq V_{DDHI} \leq 3.60V$**

| SYMBOL         | DESCRIPTION  | Conditions   | MIN | TYP                             | MAX | UNIT |
|----------------|--|--------------|-----|---------------------------------|-----|------|
| $t_{START-UP}$ | Start-up time before the first communication is initiated by the IQS213(A) |              |     | 15                              |     | ms   |
| $f_{CX}$       | Charge transfer frequency  |              |     | See CHG_FRQ in Section 8.3      |     | MHz  |
| $t_{CHARGE}$   | Charge time per channel  |              |     | $CS * (1/f_{CX})$               |     | ms   |
| $t_{CHANNEL}$  | Stand-alone / I <sup>2</sup> C Mode  | Normal Power |     | 2.6 / 3.9                       |     | ms   |
| $t_{SAMPLE}$   |  |              |     | Active channels * $t_{CHANNEL}$ |     | ms   |
| $t_{WDT}$      | WDT time-out while communicating   |              |     | 160                             |     | ms   |

**Table 11.9 IQS213(A) Charging Times**

| POWER MODE        | TYPICAL (ms) |                  |
|-------------------|--------------|------------------|
|                   | Stand-alone  | I <sup>2</sup> C |
| Normal Power Mode | 2.6          | 3.9              |
| Low Power Mode 1  | 128          | 128              |
| Low Power Mode 2  | 256          | 256              |
| Low Power Mode 3  | 512          | 512              |

\*\*NOTE: with ACF = ON, “wake-on-prox” times will increase due to the CS having to go through an additional filtering process adding a delay.

Please refer to “**Application Note AZD079 – IQS213 Touch response rate**” for more information.

## 12 Packaging Information

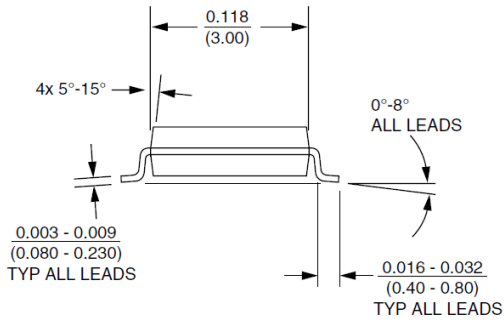

Figure 12.1 MSOP-10 Back view.

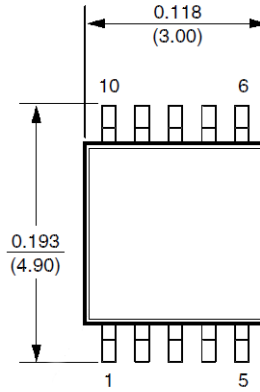

Figure 12.3 MSOP-10 Top view.

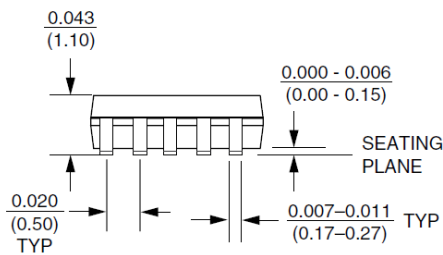

Figure 12.2 MSOP-10 Side view.

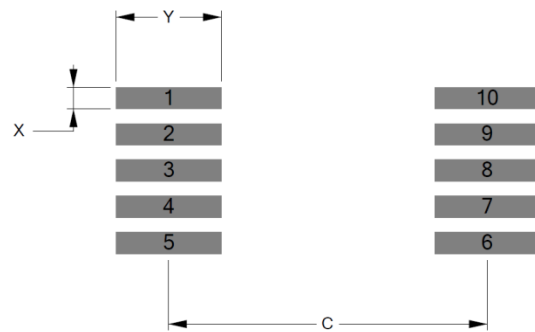

Figure 12.4 MSOP-10 Footprint.

Table 12.1 MSOP-10 Footprint Dimensions from Figure 12.4.

| Dimension | [mm] |
|-----------|------|
| Pitch     | 0.50 |
| C         | 4.40 |
| Y         | 1.45 |
| X         | 0.30 |



## 13 Device Marking

### 13.1 Top marking

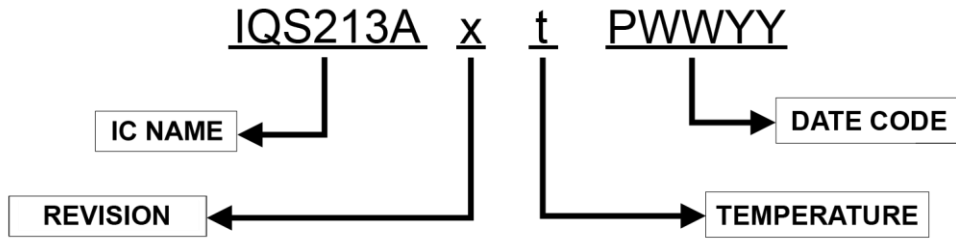

|                          |                    |  |
|--------------------------|--------------------|--|
| <b>IC NAME</b>           | <b>IQS213(A)</b> = | IQS213(A)  |
| <b>REVISION</b>          | <b>x</b> =         | IC Revision Number   |
| <b>TEMPERATURE RANGE</b> | <b>t</b> =         | i    -40°C to 85°C (Industrial)<br>c    0°C to 70°C (Commercial) |
| <b>DATE CODE</b>         | <b>P</b> =         | Package House  |
|                          | <b>WW</b> =        | Week   |
|                          | <b>YY</b> =        | Year   |

### 13.2 Bottom Marking

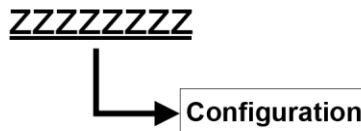

|                      |                   |   |
|----------------------|-------------------|---|
| <b>Configuration</b> | <b>ZZZZZZZZ</b> = | Device Configuration /<br>User Programmable Options<br>[Default = 00000000] |
|----------------------|-------------------|---|



## 14 Ordering Information

Orders will be subject to a MOQ (Minimum Order Quantity) of a full reel. Contact the official distributor for sample quantities. A list of the distributors can be found under the “Distributors” section of [www.azoteq.com](http://www.azoteq.com).

### 14.1 General Part Order Number

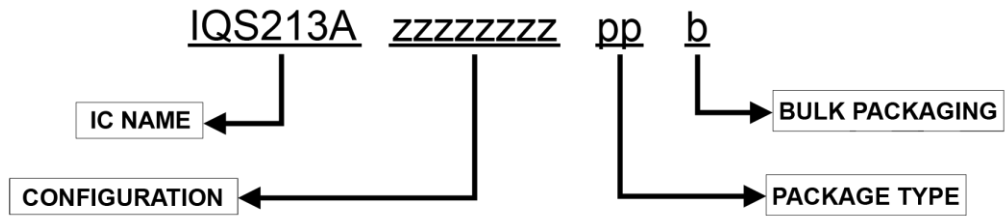

|                       |                  |   |                                    |
|-----------------------|------------------|---|------------------------------------|
| <b>IC NAME</b>        | <b>IQS213(A)</b> | = | <b>IQS213(A)</b>                   |
| <b>CONFIGURATION</b>  | <i>zzzzzzzz</i>  | = | User Programmable Option Selection |
| <b>PACKAGE TYPE</b>   | MS               | = | MSOP10                             |
| <b>BULK PACKAGING</b> | R                | = | Reel (4000pcs/reel)                |



## 15 Contact Information

|                         | <b>USA</b>  | <b>Asia</b>   | <b>South Africa</b>                                  |
|-------------------------|---|---|--|
| <b>Physical Address</b> | 6507 Jester Blvd<br>Bldg 5, suite 510G<br>Austin<br>TX 78750<br>USA | Rm1725, Glittery City<br>Shennan Rd<br>Futian District<br>Shenzhen, 518033<br>China | 109 Main Street<br>Paarl<br>7646<br>South Africa     |
| <b>Postal Address</b>   | 6507 Jester Blvd<br>Bldg 5, suite 510G<br>Austin<br>TX 78750<br>USA | Rm1725, Glittery City<br>Shennan Rd<br>Futian District<br>Shenzhen, 518033<br>China | PO Box 3534<br>Paarl<br>7620<br>South Africa         |
| <b>Tel</b>              | +1 512 538 1995   | +86 755 8303 5294<br>ext 808  | +27 21 863 0033                                      |
| <b>Fax</b>              | +1 512 672 8442   |   | +27 21 863 1512                                      |
| <b>Email</b>            | <a href="mailto:kobusm@azoteq.com">kobusm@azoteq.com</a>            | <a href="mailto:linayu@azoteq.com.cn">linayu@azoteq.com.cn</a>                      | <a href="mailto:info@azoteq.com">info@azoteq.com</a> |

Please visit [www.azoteq.com](http://www.azoteq.com) for a list of distributors and worldwide representation.

The following patents relate to the device or usage of the device: US 6,249,089 B1, US 6,621,225 B2, US 6,650,066 B2, US 6,952,084 B2, US 6,984,900 B1, US 7,084,526 B2, US 7,084,531 B2, US 7,265,494 B2, US 7,291,940 B2, US 7,329,970 B2, US 7,336,037 B2, US 7,443,101 B2, US 7,466,040 B2, US 7,498,749 B2, US 7,528,508 B2, US 7,755,219 B2, US 7,772,781, US 7,781,980 B2, US 7,915,765 B2, US 7,994,726 B2, US 8,035,623 B2, US 8,288,952 B2, EP 1 120 018 B1, EP 1 206 168 B1, EP 1 308 913 B1, EP 1 530 178 B1, ZL 200880005683.2, ZL 99 8 14357.X, AUS 761094, HK 104 14100A

IQ Switch®, SwipeSwitch™, ProxSense®, LightSense™, AirButton® and the  logo are trademarks of Azoteq.

The information in this Datasheet is believed to be accurate at the time of publication. Azoteq uses reasonable effort to maintain the information up-to-date and accurate, but does not warrant the accuracy, completeness or reliability of the information contained herein. All content and information are provided on a "as is" basis only, without any representations or warranties, express or implied, of any kind, including representations about the suitability of these products or information for any purpose. Azoteq disclaims all warranties and conditions with regard to these products and information, including but not limited to all implied warranties and conditions of merchantability, fitness for a particular purpose, title and non-infringement of any third party intellectual property rights. Azoteq assumes no liability for any damages or injury arising from any use of the information or the product or caused by, without limitation, failure of performance, error, omission, interruption, defect, delay in operation or transmission, even if Azoteq has been advised of the possibility of such damages. The applications mentioned herein are used solely for the purpose of illustration and Azoteq makes no warranty or representation that such applications will be suitable without further modification, nor recommends the use of its products for application that may present a risk to human life due to malfunction or otherwise. Azoteq products are not authorized for use as critical components in life support devices or systems. No licenses to patents are granted, implicitly, express or implied, by estoppel or otherwise, under any intellectual property rights. In the event that any of the abovementioned limitations or exclusions does not apply, it is agreed that Azoteq's total liability for all losses, damages and causes of action (in contract, tort (including without limitation, negligence) or otherwise) will not exceed the amount already paid by the customer for the products. Azoteq reserves the right to alter its products, to make corrections, deletions, modifications, enhancements, improvements and other changes to the content and information, its products, programs and services at any time or to move or discontinue any contents, products, programs or services without prior notification. For the most up-to-date information and binding Terms and Conditions please refer to [www.azoteq.com](http://www.azoteq.com).

**[WWW.AZOTEQ.COM](http://WWW.AZOTEQ.COM)**

[info@azoteq.com](mailto:info@azoteq.com)