



#### FEATURES

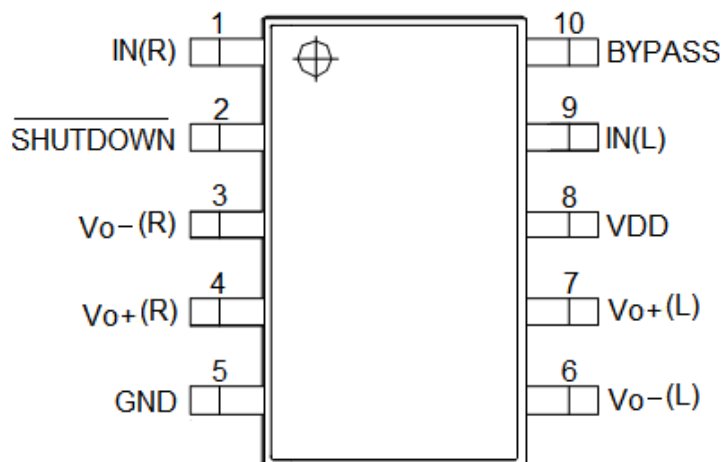
- 3.3W **Stereo** into 4Ω from 5.5V power supply at THD+N = 10% (Typ.).
- 2.0W **Stereo** into 8Ω from 5.5V power supply at THD+N = 10% (Typ.).
- 2.5V~5.5V Power supply.
- Low shutdown current.
- Low quiescent current.
- Output pin short-circuit protection and automatic recovery.
- Over-Heat Protection and automatic recovery.
- Minimum external components.
- No output filter required for inductive loads.
- Low noise during turn-on and turn-off transitions.
- Lead free and green package available. (RoHS Compliant)
- Package : 10pin 150mil MSOP (without thermal pad) available.

#### APPLICATION

- Portable electronic devices.
- Mobile phones.
- USB audio.
- Speaker docking.
- Bluetooth speaker.

#### PIN CONFIGURATION

#### LY8209 MSOP10 pin configuration (TOP VIEW)



#### GENERAL DESCRIPTION

The LY8209 is a high efficiency, high quality 3.3W stereo class D audio power amplifier. It is a low noise, filterless PWM architecture eliminates the output filter, reducing external component count, system cost, and simplify design.

The device is designed to meet of Multimedia application includes mobile phones , mini speaker and other portable electronic devices.

The LY8209 is a single 5.5V power supply, it is capable of driving 4Ω speaker load at a continuous average output of 3.3W/CH with 10% THD+N.

The device also features an internal thermal shutdown protection and output pin short-circuit protection prevent the device from damage during fault conditions.

The LY8209 is easily to be used in various portable applications and products.



#### PIN DESCRIPTION

SYMBOL	Pin No.	DESCRIPTION
	MSOP10	
INR	1	Input of right channel.
Shutdown	2	Shutdown control pin. (when <b>LOW</b> level is shutdown mode).
Vo-(R)	3	Negative(-) BTL output of right channel.
Vo+(R)	4	Positive(+) BTL output of right channel.
GND	5	Ground
Vo-(L)	6	Negative(-) BTL output of left channel.
Vo+(L)	7	Positive(+) BTL output of left channel.
VDD	8	Power supply of left and right channel.
INL	9	Input of left channel.
BYPASS	10	Bypass pin.

#### ORDERING INFORMATION

Ordering Code	Speaker Channels	Pin/ Package	Output Power (THD+N=10%)	Input Type	Output Type
LY8209U	Stereo	MSOP10	3.3W/4Ω @5.5V_BTL 2.8W/4Ω @5.0V_BTL 2.0W/8Ω @5.5V_BTL 1.6W/8Ω @5.0V_BTL	SE	BTL

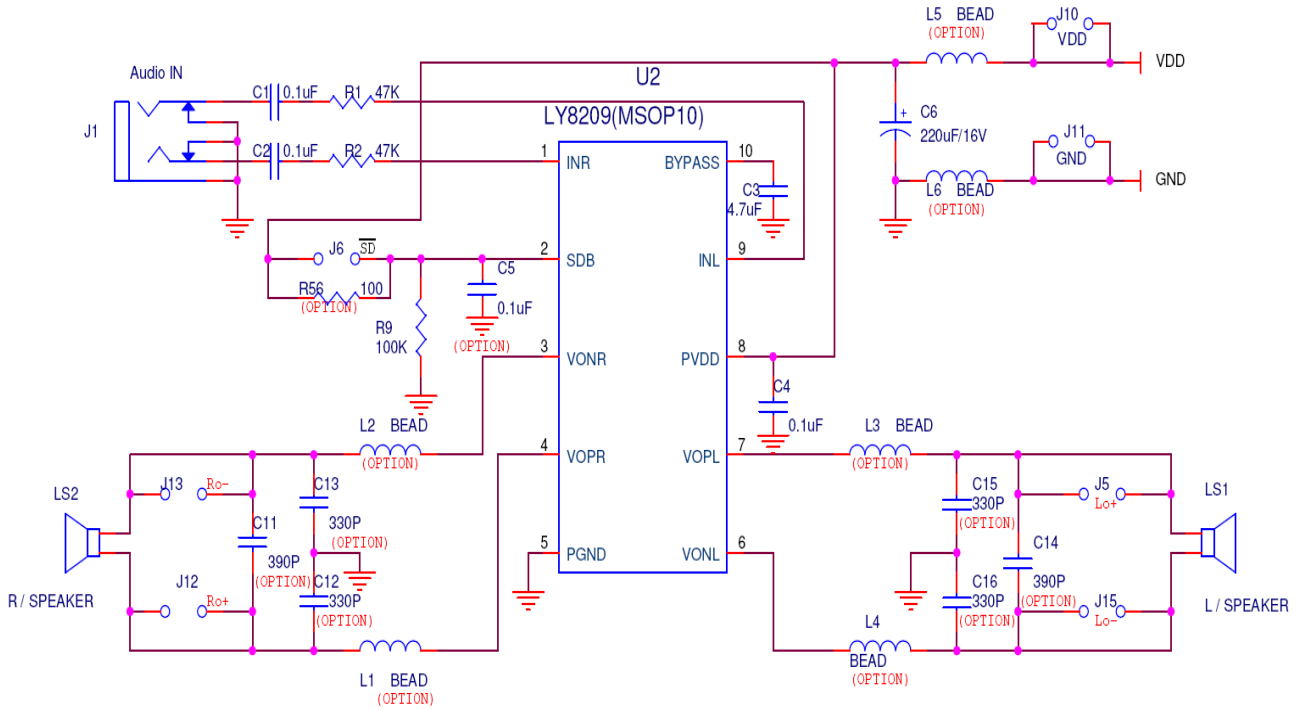
**■ TYPICAL APPLICATION CIRCUIT**


Figure 1. LY8209 Typical Application Circuit

**■ ABSOLUTE MAXIMUM RATINGS**

PARAMETER	SYMBOL	RATING	UNIT
Supply Voltage	V <sub>DD</sub>	6.0	V
Operating Temperature	T <sub>A</sub>	-40 to 85 (I grade)	°C
Input Voltage	V <sub>i</sub>	-0.3V to V <sub>DD</sub> +0.3V	V
Storage Temperature	T <sub>STG</sub>	-65 to 150	°C
Power Dissipation	P <sub>D</sub>	Internally Limited	W
ESD Susceptibility	V <sub>ESD</sub>	2000	V
Junction Temperature	T <sub>JMAX</sub>	150	°C
Soldering Temperature (under 10 sec)	T <sub>SOLDER</sub>	260	°C



#### **ELECTRICAL CHARACTERISTICS** (T<sub>A</sub> = 25°C)

PARAMETER	SYMBOL	TEST CONDITION	MIN.	TYP. <sup>*2</sup>	MAX.	UNIT
Power supply voltage	V <sub>DD</sub>	-	2.5	-	5.5	V
Quiescent Current	I <sub>Q</sub>	V <sub>DD</sub> = 5.0V, R <sub>L</sub> =4Ω	-	6.5	-	mA
		V <sub>DD</sub> = 3.7V, R <sub>L</sub> =4Ω	-	5.5	-	
		V <sub>DD</sub> = 2.5V, R <sub>L</sub> =4Ω	-	5.0	-	
Shutdown Current	I <sub>SD</sub>	V <sub>SHUTDOWN</sub> ≤ 0.8V,	-	0.1	-	μA
Shutdown voltage input high	V <sub>SDIH</sub>	V <sub>DD</sub> = 5.0V	1.5	-	-	V
Shutdown voltage input low	V <sub>SDIL</sub>		-	-	0.3	
Output offset voltage	V <sub>OS</sub>	V <sub>DD</sub> = 5.0V, V <sub>I</sub> =0V, A <sub>v</sub> =11V/V	-	-	95	mV
Thermal shutdown temperature	T <sub>SD</sub>	Shutdown temp.	-	150	-	°C
		Restore temp.	-	110	-	
Total Gain <sup>*1</sup>	G <sub>V</sub>	V <sub>DD</sub> = 2.5V to 5.5V	[150KΩ / (5KΩ+R <sub>i</sub> )] x4			V/V

(\*1)The audio amplifier's gain is determined by :

$$\text{Pre-Amplifier Gain} = [150K\Omega / (5K\Omega + R_i)] \times 2$$

$$\text{Total Gain} = \{ [150K\Omega / (5K\Omega + R_i)] \times 2 \} \times 2$$

where R<sub>i</sub> is the external serial resistance at the input pin.

(\*2)Typical values are included for reference only and are not guaranteed or tested.

Typical values are measured at V<sub>DD</sub> = V<sub>DD</sub>(TYP.) and T<sub>A</sub> = 25°C

#### **OPERATING CHARACTERISTICS (1) (Stereo mode)** (T<sub>A</sub> = 25°C)

PARAMETER	SYMBOL	TEST CONDITION	MIN.	TYP. <sup>*2</sup>	MAX.	UNIT	
Power supply rejection ratio	PSRR	A <sub>v</sub> =11 V/V, Input=GND R <sub>i</sub> =51K, C <sub>i</sub> =0.1μF R <sub>L</sub> =40hm, V <sub>DD</sub> =5.0V	f=1kHz	-	-58	-	dB
			f=217Hz	-	-59	-	
Crosstalk (Stereo mode)	C <sub>s</sub>	0.25W=0dB, f=1kHz, R <sub>L</sub> = 4Ω, V <sub>DD</sub> =5.0V	L→R	-	-77	-	dB
			R→L	-	-80	-	
Signal-to-noise ratio	SNR	A <sub>v</sub> =11 V/V, R <sub>L</sub> = 8Ω, Input pin floating, 1W=0dB	V <sub>DD</sub> =5.0V	-	84	-	dB
Output voltage noise	V <sub>n</sub>	A <sub>v</sub> =11 V/V, R <sub>L</sub> = 8Ω, Input pin floating, f = 20 Hz to 20 kHz,	V <sub>DD</sub> =5.0V	-	130	-	uV <sub>RMS</sub>
Frequency	F <sub>c</sub>	V <sub>DD</sub> =2.5V~5.5V	-	220	-	kHz	
Efficiency	η	V <sub>DD</sub> =5.0V, f=1kHz, R <sub>L</sub> =8Ω, Output=1.8W	-	89	-	%	

(\*2)Typical values are included for reference only and are not guaranteed or tested.

Typical values are measured at V<sub>DD</sub> = V<sub>DD</sub>(TYP.) and T<sub>A</sub> = 25°C



#### ■ OPERATING CHARACTERISTICS (2) (T<sub>A</sub> = 25°C)

PARAMETER	SYMBOL	TEST CONDITION	MIN.	TYP. <sup>2</sup>	MAX.	UNIT	
Output Power	P <sub>o</sub>	THD+N= 10%, f = 1 kHz R <sub>L</sub> = 4Ω	V <sub>DD</sub> =5.5V	-	3.3	-	W
			V <sub>DD</sub> =5.0V	-	2.8	-	
			V <sub>DD</sub> =3.7V	-	1.5	-	
		THD+N= 1%, f = 1 kHz, R <sub>L</sub> = 4Ω	V <sub>DD</sub> =5.5V	-	2.7	-	
			V <sub>DD</sub> =5.0V	-	2.2	-	
			V <sub>DD</sub> =3.7V	-	1.2	-	
		THD+N= 10%, f = 1 kHz R <sub>L</sub> = 8Ω	V <sub>DD</sub> =5.5V	-	2.0	-	
			V <sub>DD</sub> =5.0V	-	1.6	-	
			V <sub>DD</sub> =3.7V	-	0.9	-	
		THD+N= 1%, f = 1 kHz, R <sub>L</sub> = 8Ω	V <sub>DD</sub> =5.5V	-	1.6	-	
			V <sub>DD</sub> =5.0V	-	1.3	-	
			V <sub>DD</sub> =3.7V	-	0.7	-	
		V <sub>DD</sub> =2.5V	-	0.3	-		

(\*2)Typical values are included for reference only and are not guaranteed or tested.  
 Typical values are measured at V<sub>DD</sub> = V<sub>DD</sub>(TYP.) and T<sub>A</sub> = 25°C

#### ■ TYPICAL PERFORMACE CHARACTERISTICS

Figure 2.  
 Total Harmonic Distortion + Noise vs Output Power (R<sub>L</sub> = 4Ω, Stereo mode)

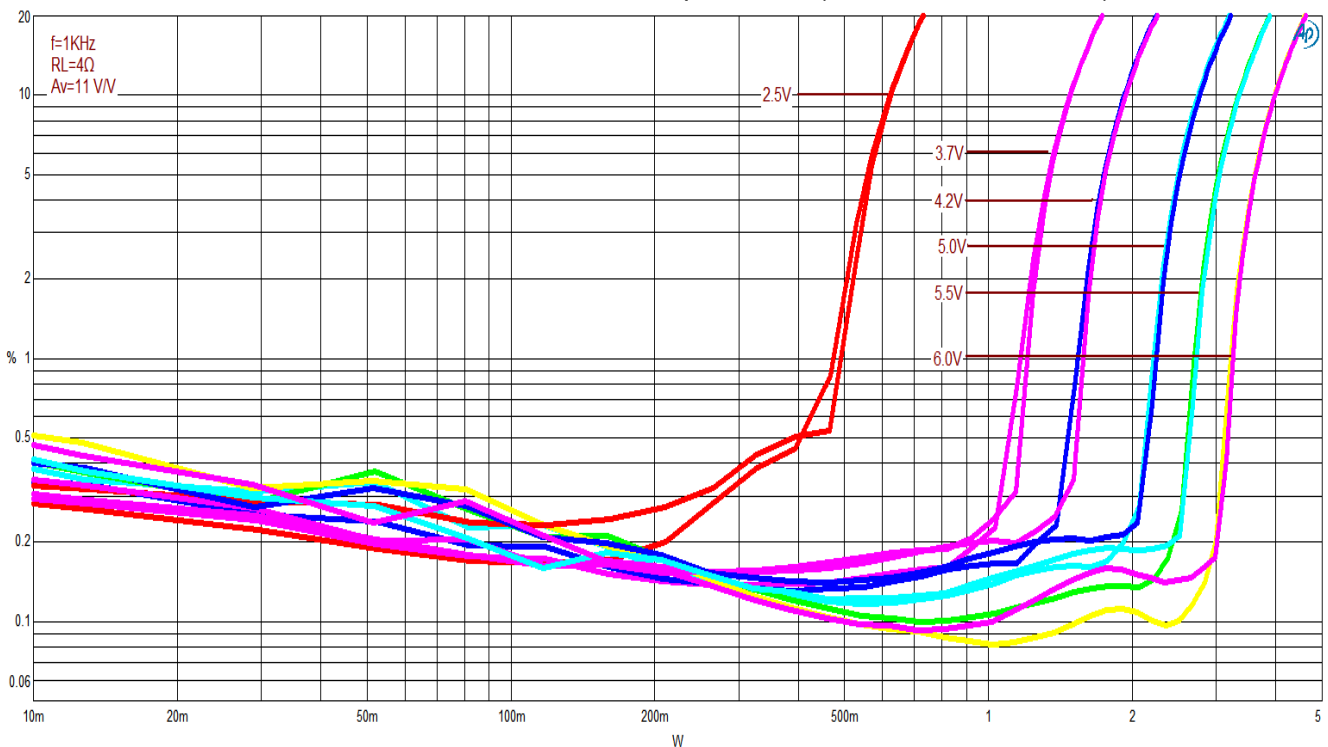




Figure 3.  
Total Harmonic Distortion + Noise vs Output Power ( $R_L = 8\Omega$ , Stereo mode)

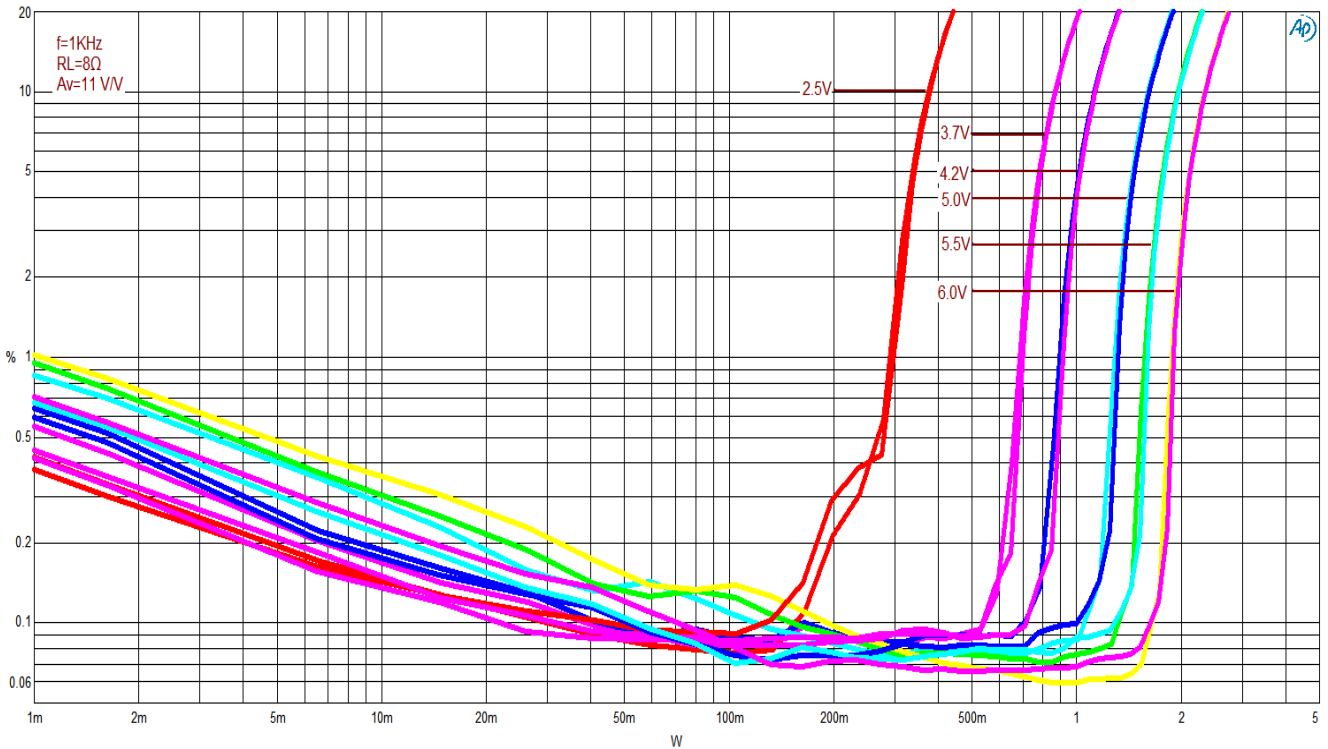


Figure 4.  
SNR vs. Noise Level

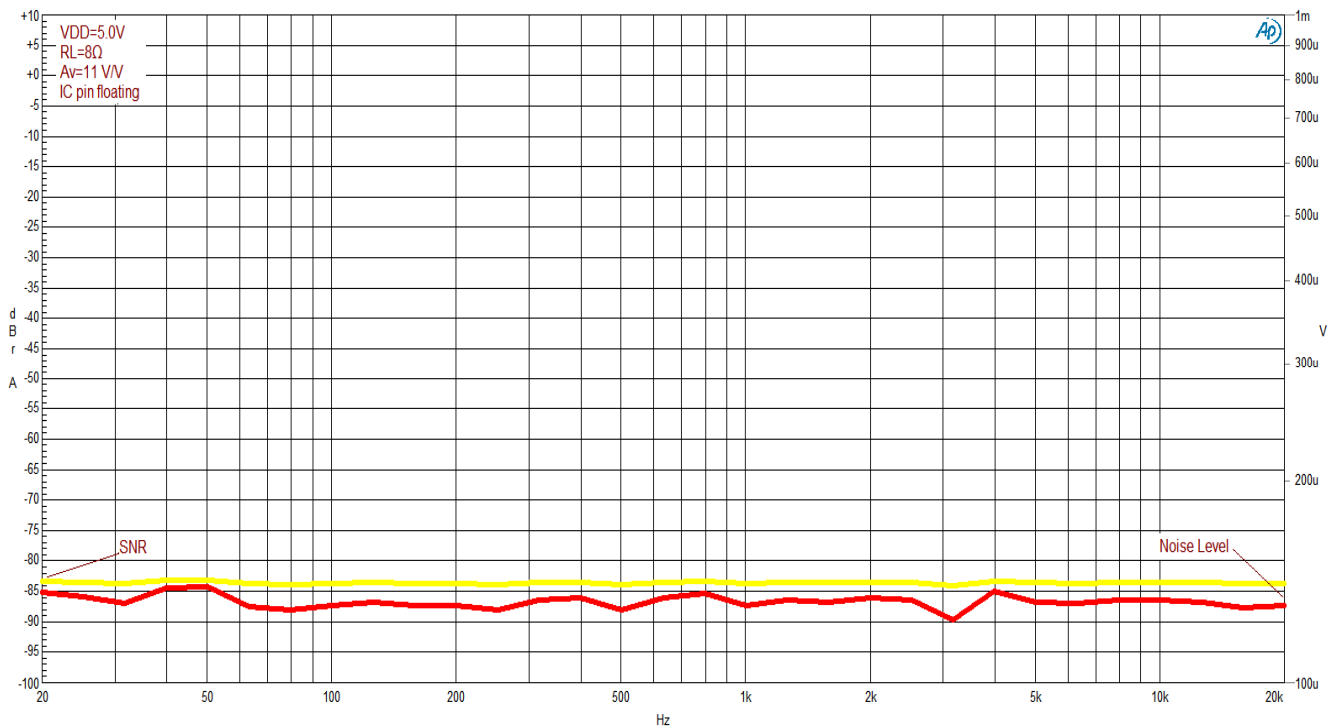


Figure 5.  
Crosstalk

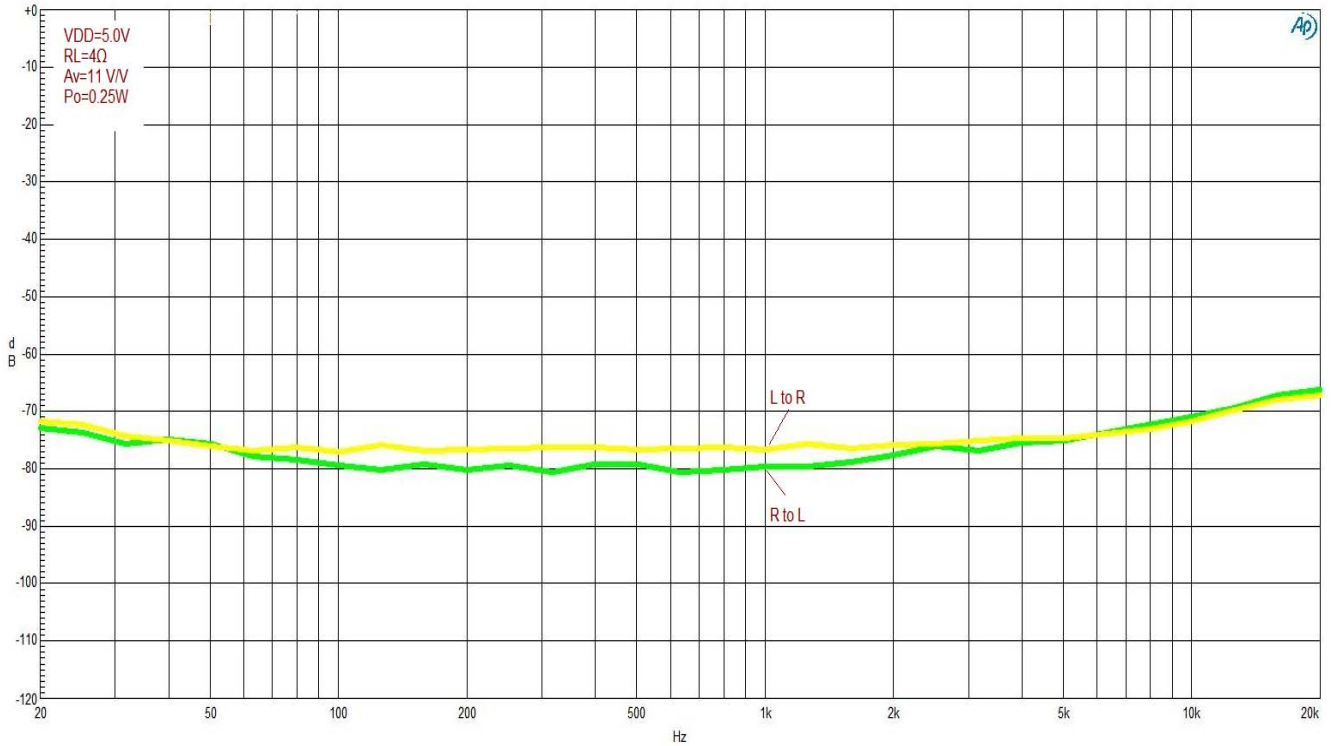
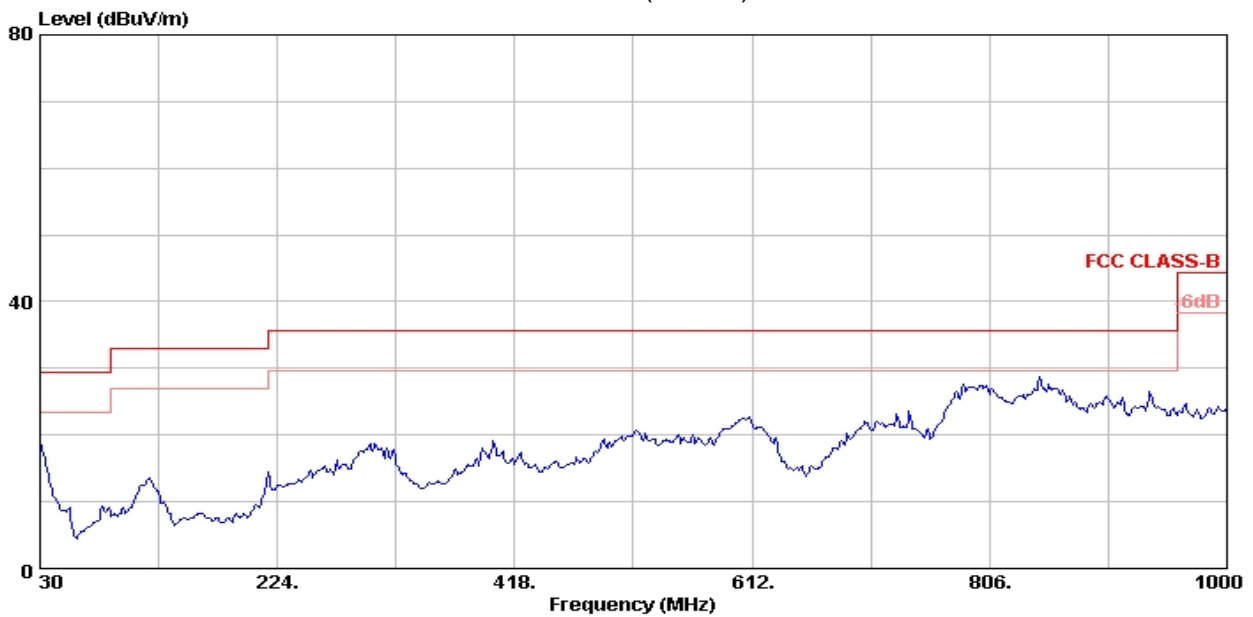


Figure 6  
FCC Class-B (Vertical)

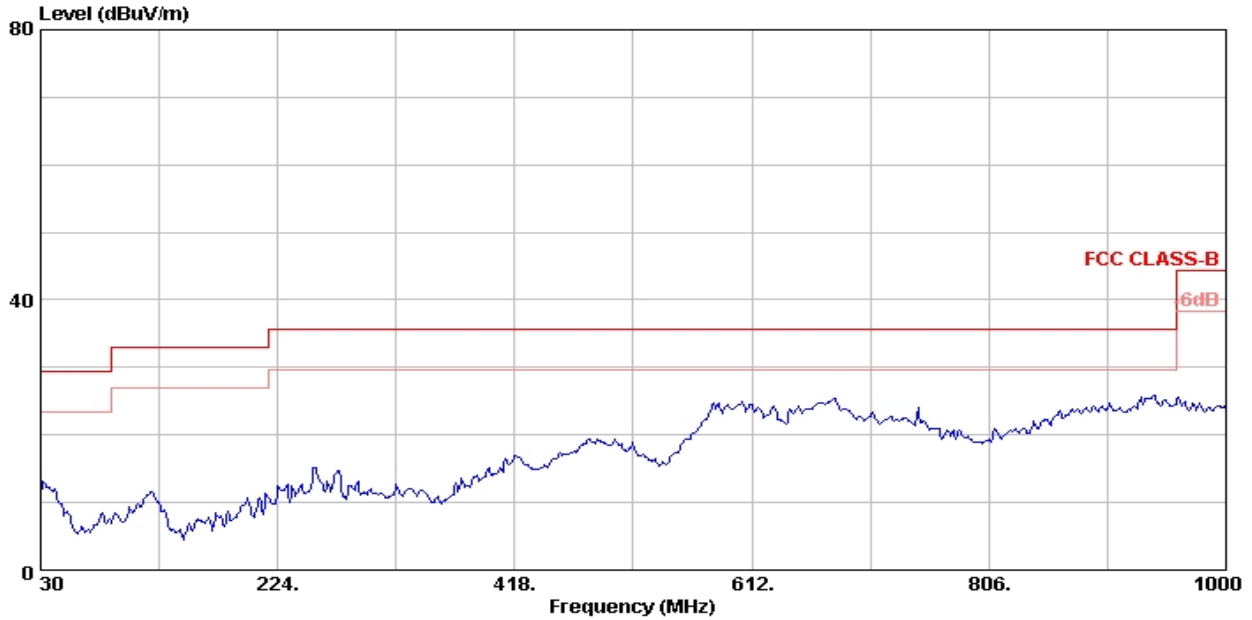


```

Site           : chamber size: 7m X 4m X 3m
Condition      : FCC CLASS-B 10m LESRTEK(QUIT-TEK) VERTICAL
cut            : LY8209
mode           :
memo           : with mp3
  
```

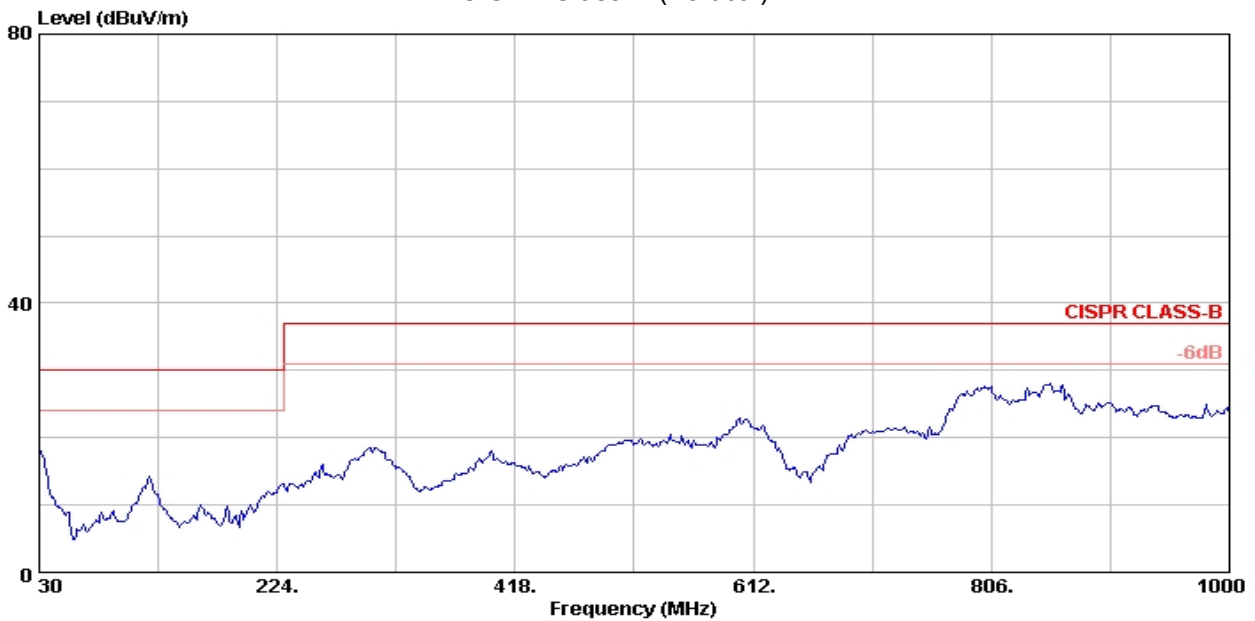


Figure 7  
FCC Class-B (Horizontal)



Site : chamber size: 7m X 4m X 3m  
Condition : FCC CLASS-B 10m LESRTEK(QUIT-TEK) HORIZONTAL  
eut : LY8209  
mode :  
memo : with mp3

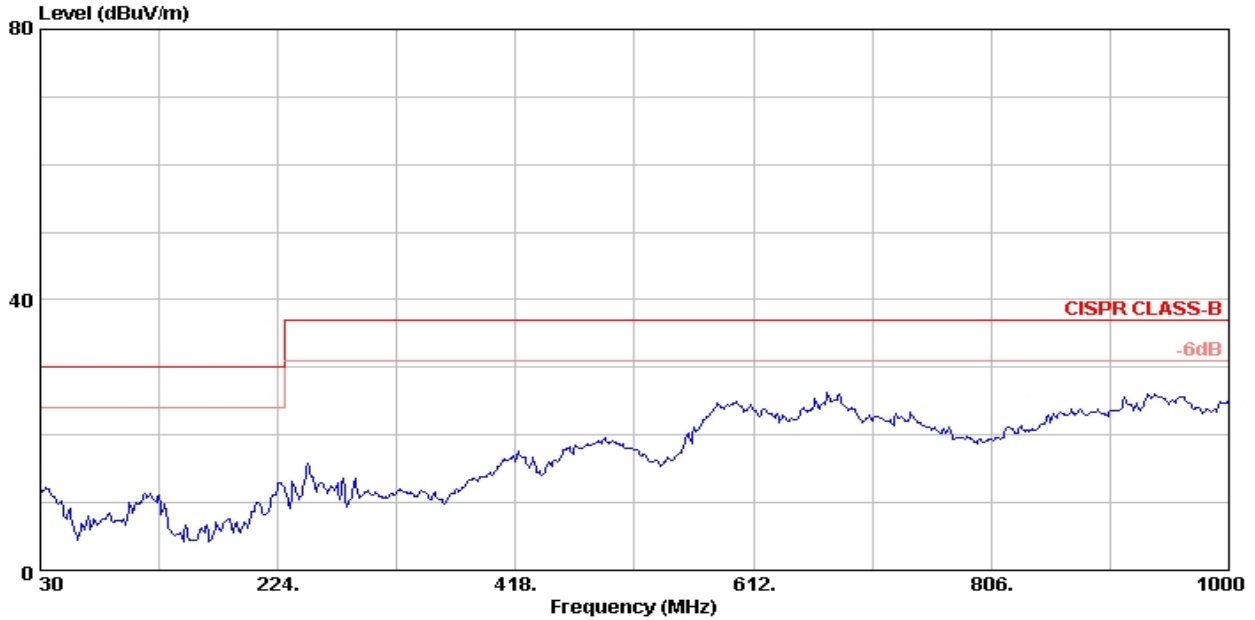
Figure 8  
CISPR Class-B (Vertical)



Site : chamber size: 7m X 4m X 3m  
Condition : CISPR CLASS-B 10m LESRTEK(QUIT-TEK) VERTICAL  
eut : LY8209  
mode :  
memo : with mp3

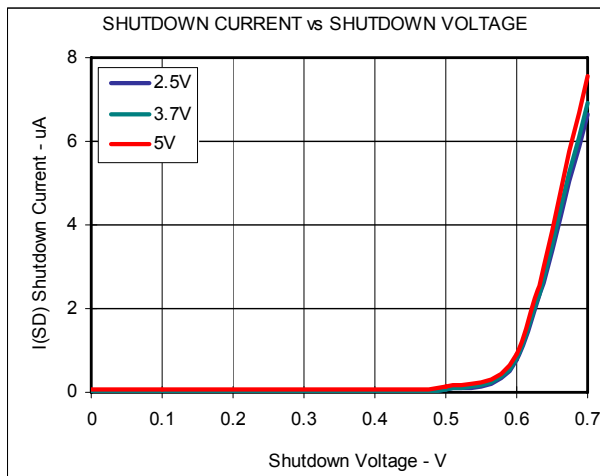


Figure 9  
CISPR Class-B ( Horizontal)

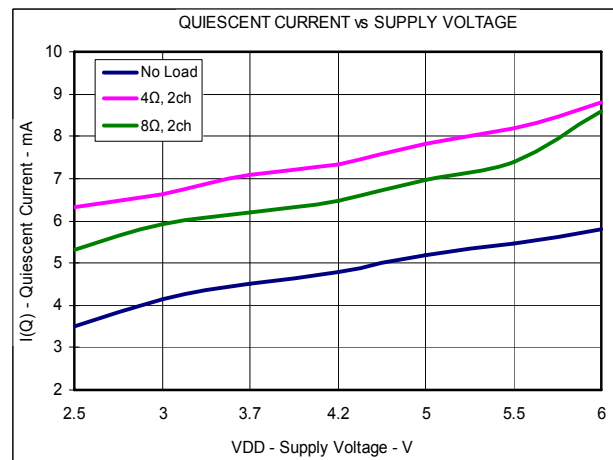


Site : chamber size: 7m X 4m X 3m  
 Condition : CISPR CLASS-B 10m LESRTEK(QUIT-TEK) HORIZONTAL  
 eut : LY8209  
 mode :  
 memo : with mp3

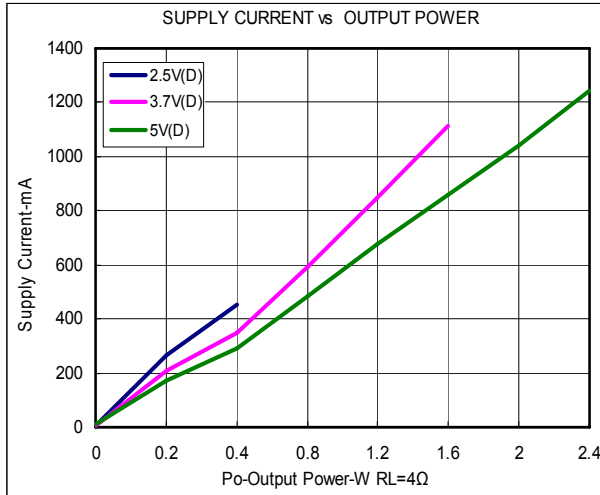
SD Current vs. SD Voltage



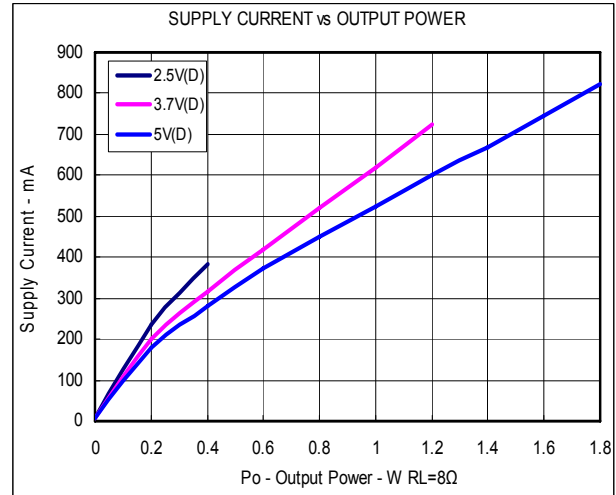
Quiescent Current vs. Supply voltage



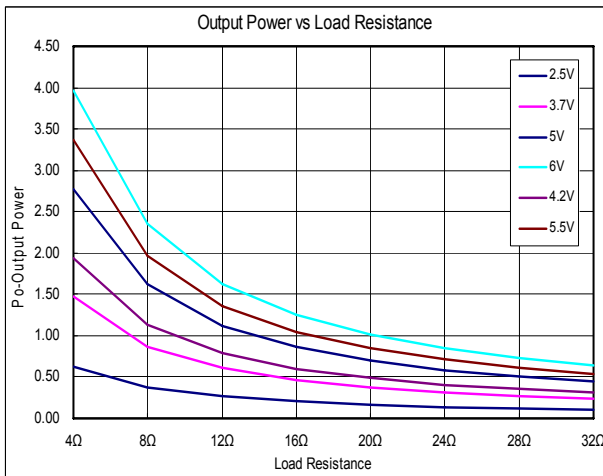
Supply Current vs. Output Power (RL=4Ω)



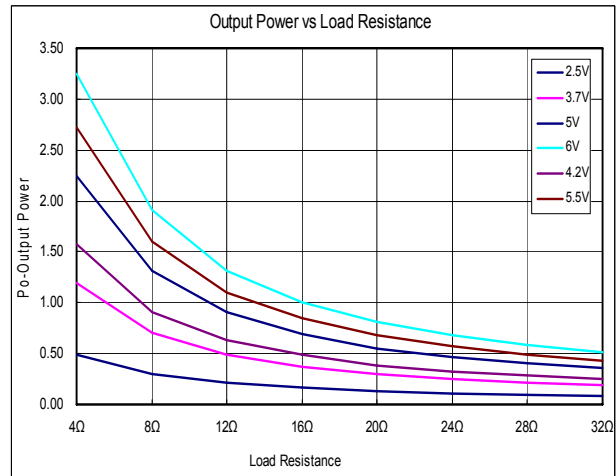
Supply Current vs. Output Power (RL=8Ω)



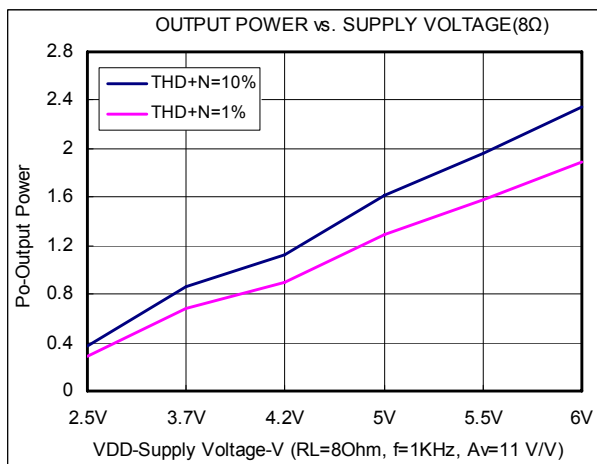
Load Resistance vs. Output Power (THD+N=10%)



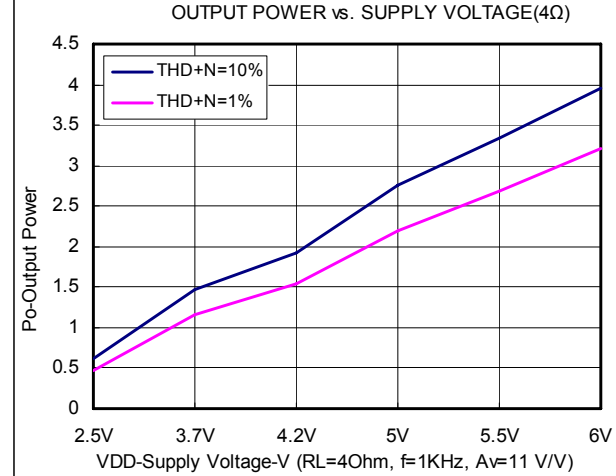
Load Resistance vs. Output Power (THD+N=1%)



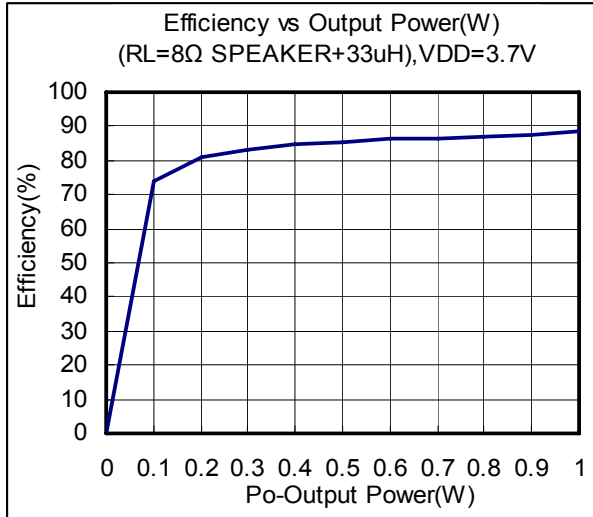
Output Power vs. VDD (RL=80Ωm)



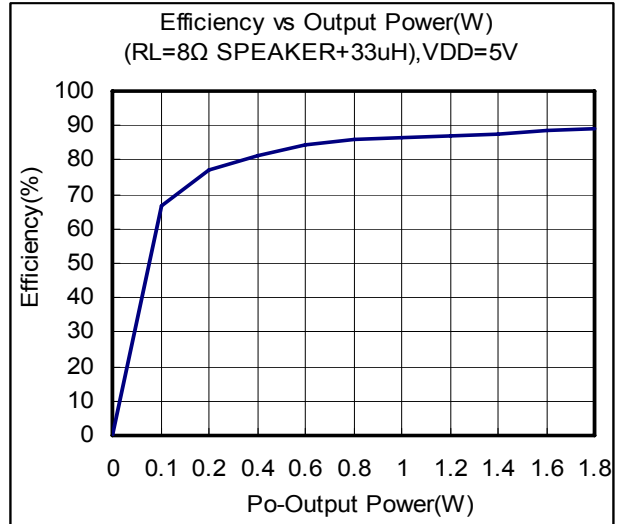
Output Power vs. VDD (RL=40Ωm)



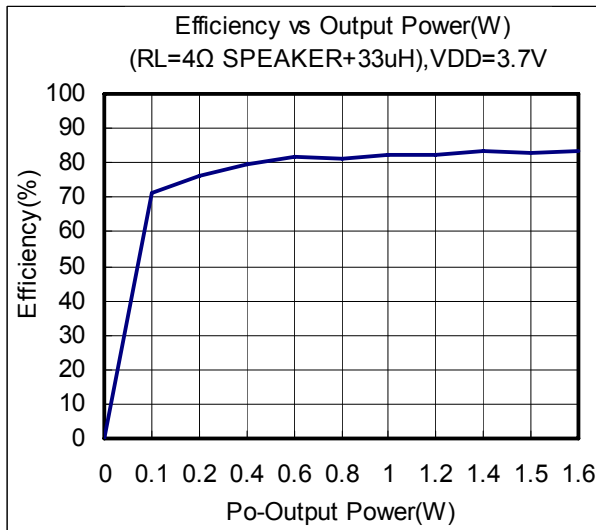
Efficiency vs. Output Power (80hm) 3.7V



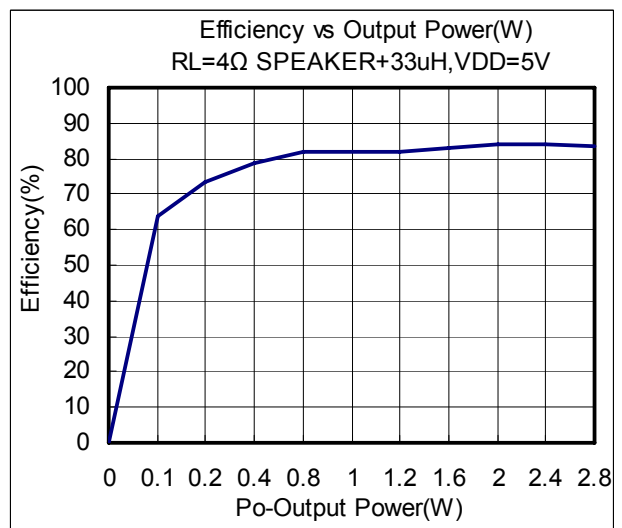
Efficiency vs. Output Power (80hm) 5.0V



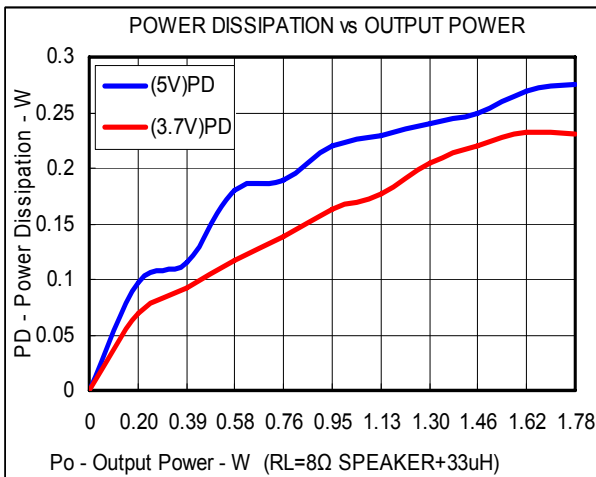
Efficiency vs. Output Power (40hm) 3.7V



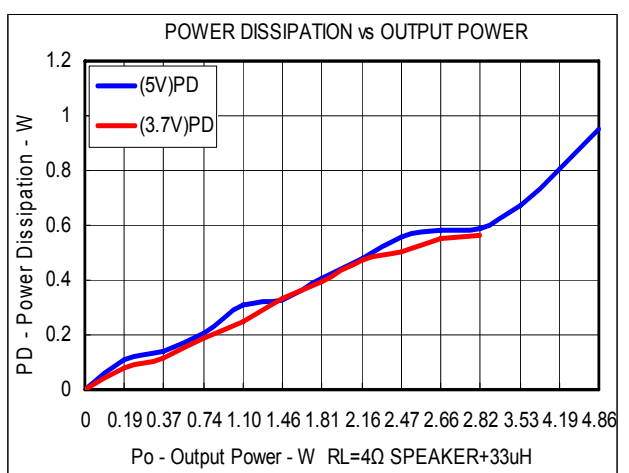
Efficiency vs. Output Power (40hm) 5.0V



Dissipation vs. Output Power (80hm)



Dissipation vs. Output Power (40hm)



## ■ APPLICATION INFORMATION

### Input Resistors (Ri) and Gain

The LY8209 have two internal amplifier stages. The pre-amplifier gain is externally configurable, while the total gain is internally fixed. The closed-loop gain of the pre-amplifier gain is set by selecting the Rf (Rf=150KΩ) to Ri while the total gain is fixed at 4x. So the input resistors (Ri) set the gain of the amplifier according to the equation.

$$\text{Pre-Amplifier Gain} = (R_f / R_i) \times 2$$

$$\text{Total Gain} = [(R_f / R_i) \times 2] \times 2$$

$$A_{VD} = 20 \times \log [4 \times (R_f / R_i)]$$

The resistor matching is very important in the amplifiers. Balance of the output on the reference voltage depends on matched ratio of the resistors. CMRR, PSRR, and cancellation of the second harmonic distortion if resistor mismatch occurs. Therefore, it is recommended to use 1% tolerance resistors or better to keep the performance optimized. Matching is more important than overall tolerance.

Resistor arrays with 1% matching can be used with a tolerance greater than 1%. Place the input resistors very close to the LY8209 to limit noise injection on the high-impedance nodes. For optimal performance the gain should be set to 4 V/V or lower. Lower gain allows the LY8209 to operate at its best,

### For example

**Table 1. Typical Total Gain and AvD Values**

Rf (KΩ)	150	150	150	150	150
Ri (KΩ)	150	75	50	25	15
Pre AMP. Gain	2	4	6	12	20
Total Gain	4	8	12	24	40
AvD (db)	12.04	18.06	21.58	27.60	32.04

### Input Capacitors (Ci)

The LY8209 using fully differential source, So the input coupling capacitors are required. The input capacitors and input resistors form a high-pass filter with the corner frequency( $f_c$ ), determined in the equation.

$$f_c = 1 / (2\pi R_i C_i)$$

The value of the input capacitor is important to consider as it directly affects the bass (low frequency) performance of the circuit. Speakers in wireless phones cannot usually respond well to low frequencies, so the corner frequency can be set to block low frequencies in this application. Equation is reconfigured to solve for the input coupling capacitance.

$$C_i = 1 / (2\pi R_i f_c)$$

If the corner frequency is within the audio band, the capacitors should have a tolerance of  $\pm 10\%$  or better, because any mismatch in capacitance causes an impedance mismatch at the corner frequency and below.



### For example

In the table 2 shows the external components. Rin in connect with Cin to create a high-pass filter.

**Table 2. Reference Component Values**

Reference	Description				Note
Ri	150KΩ		51 KΩ		1% tolerance resistors
Ci	0.22uF	0.1uF	0.22uF	0.1uF	80%/–20% non polarized
corner frequency	4.8Hz	10.6Hz	14.18Hz	31.2Hz	

$$C_i = 1 / ( 2\pi R_i f_c )$$

$C_i = 1 / ( 2\pi \times 150K\Omega \times 4.8Hz ) = 0.221\mu F$  , One would likely choose a value of 0.22uF as this value is commonly used.

### Bypass Capacitor (Cbypass)

The Bypass Capacitor (C3 ) is the most critical capacitor. During start-up or recovery from shutdown mode, Cbypass determines the rate at which the amplifier starts up. The Cbypass will to reduce noise caused by the power supply coupling into the output drive signal. This noise is from the internal analog reference to the amplifier, which appears as degraded the PSRR and THD+N values. The bypass capacitor (C3 ) with values of 1.0μF to 10.0μF is recommended for the best THD and noise performance. Therefore, increasing the bypass capacitor reduces clicking and popping noise from power on/off and entering and leaving shutdown.

**Table 3. CBYPASS Reference Component Values**

PARAMETER	SYMBOL	TEST CONDITION	MIN.	TYP.	MAX.	UNIT	
Start-up time from shutdown	Zi	VDD=5.0V, Ci=0.1uF, Ri=51KΩ, Av=11	Cbypass = 10.0μf	-	560	-	ms
			Cbypass = 4.7μf	-	300	-	
			Cbypass = 2.2μf	-	150	-	
			Cbypass = 1.0μf	-	120	-	
		VDD=3.7V, Ci=0.1uF, Ri=51KΩ, Av=11	Cbypass = 10.0μf	-	460	-	
			Cbypass = 4.7μf	-	250	-	
			Cbypass = 2.2μf	-	135	-	
			Cbypass = 1.0μf	-	100	-	

### Shutdown Function

When the LY8209 not in use. The device will be to turn off the amplifier to reduce power consumption. When logic low is applied to the shutdown pin, this shutdown feature will turns the amplifier off. By switching the shutdown pin connected to GND, the device supply current draw will be minimized in idle mode. The pin cannot be left floating due to the internal did not pull-up.

### Over-Heat Protection

The LY8209 has a built-in over-heat protection circuit, it will turn off all power output when the chip temperature over 150°C, the chip will return to normal operation automatically after the temperature cool down to 110°C.



#### Short-circuit Protection

The LY8209 has short circuit protection circuitry on the outputs to prevent damage when output-to-output short occurs. When a short circuit is detected on the outputs, the outputs are disabled immediately. If the short was removed, the device activates again.

#### ■ PCB LAYOUT

All the external components must place very close to the LY8209. The input resistors need to be very close to the LY8209 input pins so noise does not couple on the high impedance nodes between the input resistors and the input amplifier of the LY8209. Then place the decoupling capacitor  $C_s$ , close to the LY8209 is important for the efficiency of the class-D amplifier. Any resistance or inductance in the trace between the device and the capacitor can cause a loss in efficiency.

If device had AVDD(Analog VDD) pin, place the decoupling capacitor 0.1 $\mu$ F, close to the device pin is very important.

Making the high current traces going to VDD, GND,  $V_{O+}$  and  $V_{O-}$  pins of the LY8209 should be as wide as possible to minimize trace resistance. If these traces are too thin, the LY8209's performance and output power will decrease. The input traces do not need to be wide, but do need to run side-by-side to enable common-mode noise cancellation.

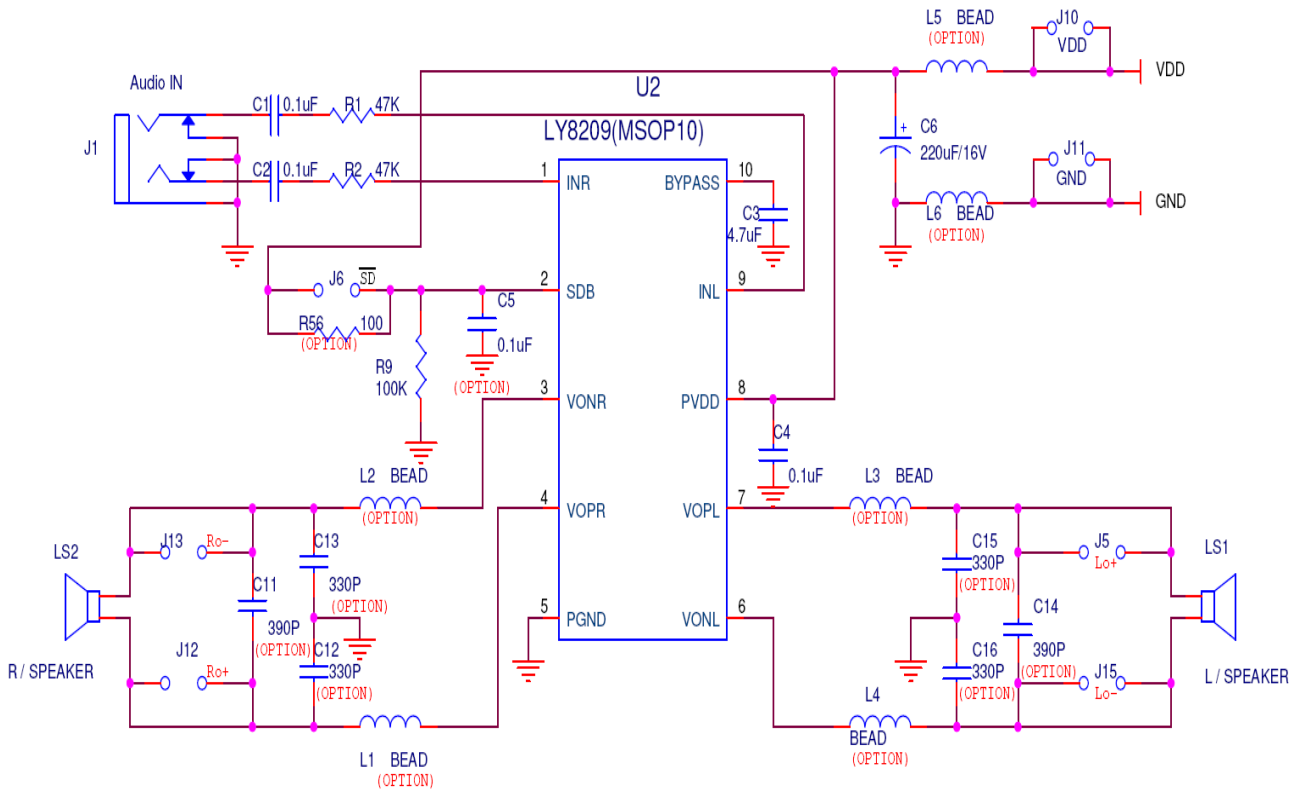
**DEMO BOARD INFORMATION**
**Demo Board Application Circuit : (Stereo Mode)**


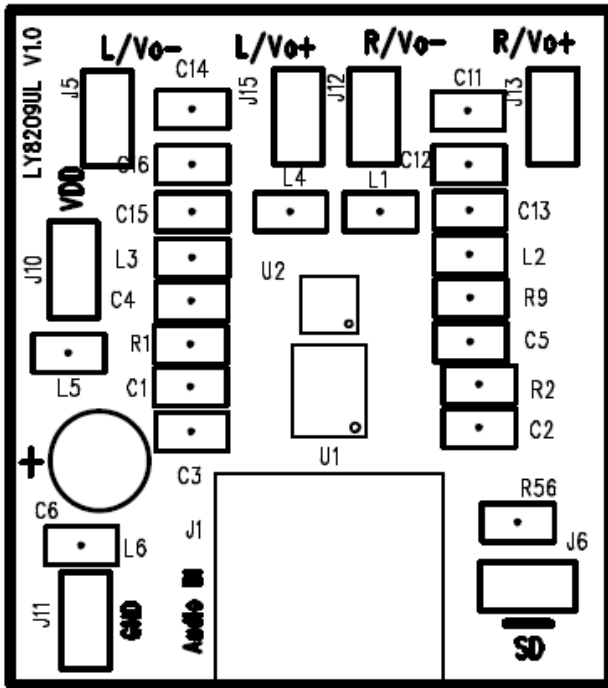
Figure 10. Demo Board Application Circuit

**Demo Board BOM List :**
*LY8209 V1.0 BOM List (Stereo Mode)*

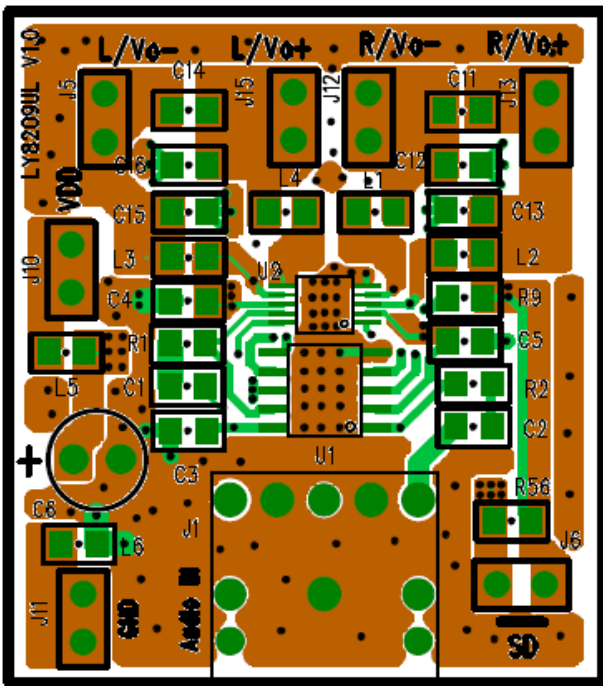
No.	Description	Reference	Note
1	Resistor, 47KΩ	R1,R2	1/16W,1%
2	Resistor, 100KΩ	R9	1/16W,1%
3	Capacitor, 0.1uF	C1,C2,C4	80%/-20%, non polarized
4	Capacitor, 4.7uF	C3	80%/-20%, non polarized
5	Capacitor, 220.0uF	C6	25V,105°C ,8x11,EC Cap.
6	IC	U2	LY8209U, (MSOP10)
7	1*2 Pin Header	J2,J6	Pitch 2.54 mm
8	Capacitor, 330pF (Option)	C12,C13,C15,C16	80%/-20%, nonpolarized
9	Capacitor, 390pF (Option)	C11,C14	80%/-20%, nonpolarized
10	Chip Bead 1KΩ/100MHz (Option)	L1,L2,L3,L4,L5,L6	1000Ω(1KΩ)±25%/100MHz

**Demo Board Artwork :**

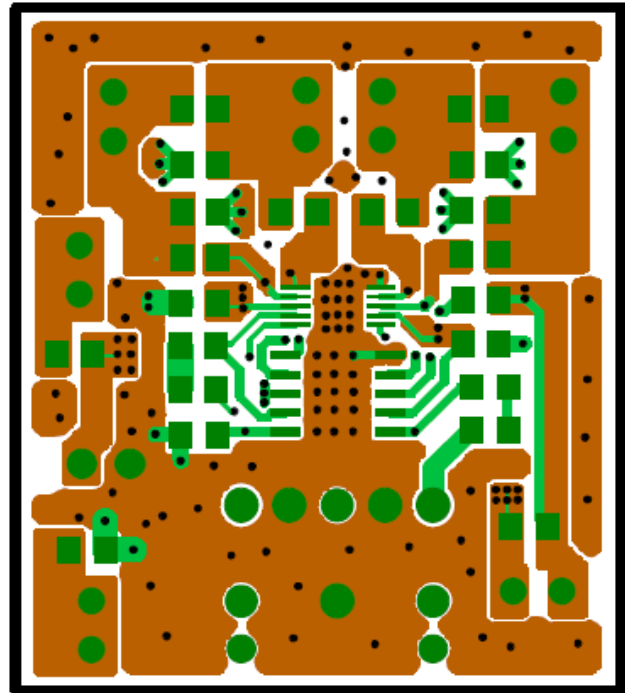
Top Silkscreen



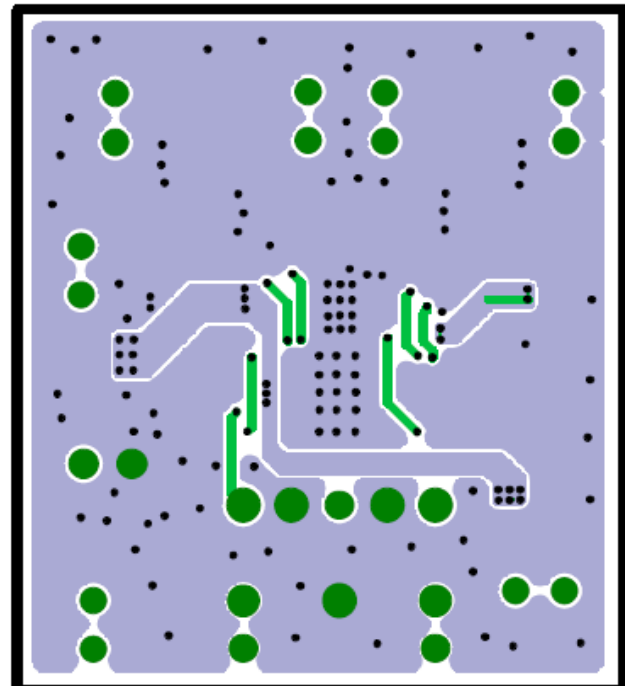
Composite view



Top Layer



Bottom Layer

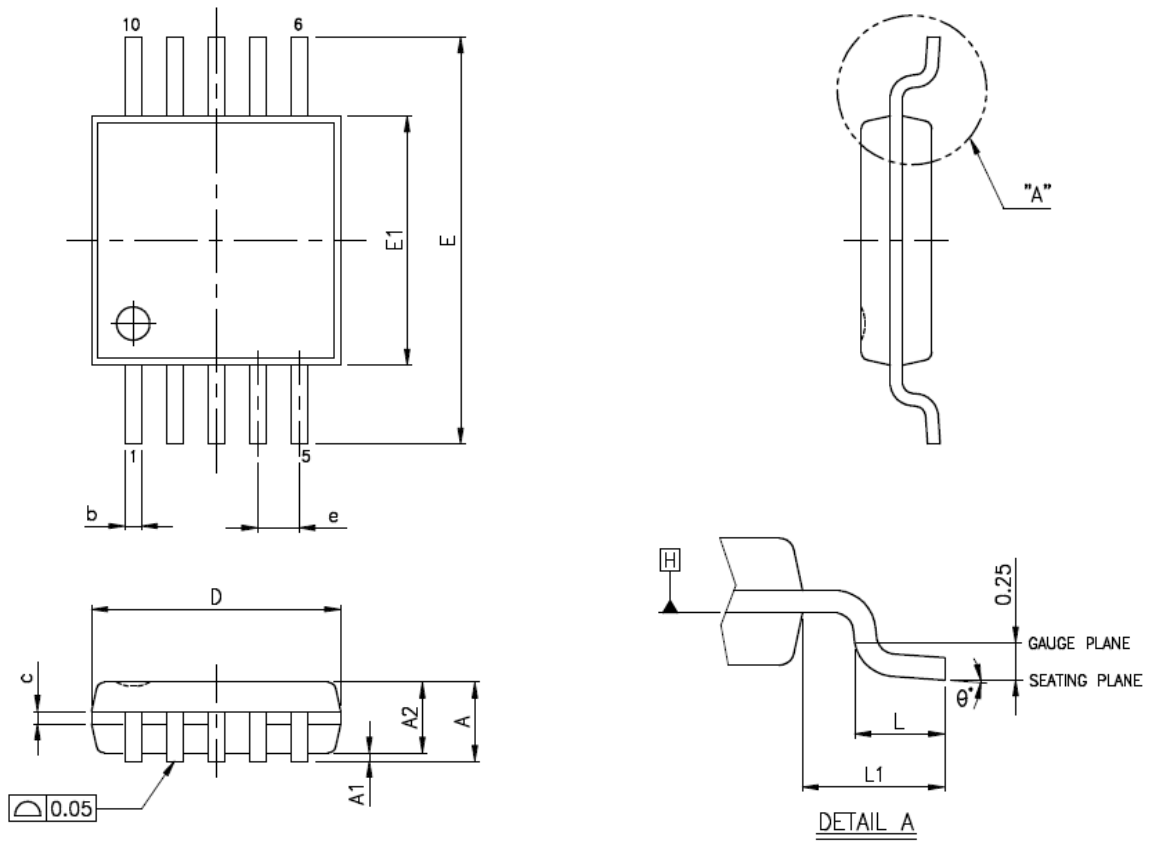






#### PACKAGE OUTLINE DIMENSION

MSOP 10 Pin Package Outline Dimension



SYMBOLS	MIN.	NOM.	MAX.
A	—	—	1.10
A1	0.00	—	0.15
A2	0.75	0.85	0.95
b	0.17	—	0.27
c	0.08	—	0.23
D	3.00 BSC		
E	4.90 BSC		
E1	3.00 BSC		
e	0.50 BSC		
L	0.40	0.60	0.80
L1	0.95 REF		
$\theta^*$	0	—	8

UNIT : MM