

FEATURES

- GENERAL PURPOSE TRANSIENT VOLTAGE PROTECTION
- MEETS UL1449 REV. 3 (File # E357747) FOR SURGE PROTECTIVE DEVICES
- CURRENT WITHSTANDING (1x UP TO 6,500A)
- TEMPERATURE RANGE -40°C ~ +85°C
- VARISTOR VOLTAGE UP TO 1,800V
- LOW CLAMPING VOLTAGES
- FLOW SOLDERING COMPATIBLE



CASE SIZE DIMENSIONS (mm)

Type	Dia.	H max.	H1 max.	T max.	L min.	L1 min.	F ± 1.0	W ± 1.0	d ± 0.05
NVR05	5.0 ~ 7.0	9.0	9.5	3.9 ~ 6.4	26.5	20	5.0	See Part Specifications Tables	0.6
NVR07	6.5 ~ 9.0	11.5	11.5	3.9 ~ 6.4	26.5	20	5.0		0.6
NVR10	9.5 ~ 13.5	15.5	16.0	4.3 ~ 10.3	26.5	20	7.5		0.8
NVR14	13.5 ~ 16.0	19.0	19.0	4.3 ~ 10.3	26.5	20	7.5		0.8
NVR20	19.5 ~ 22.0	26.5	26.5	4.7 ~ 10.7	22.5	20	10		1.0

PART NUMBERING SYSTEM

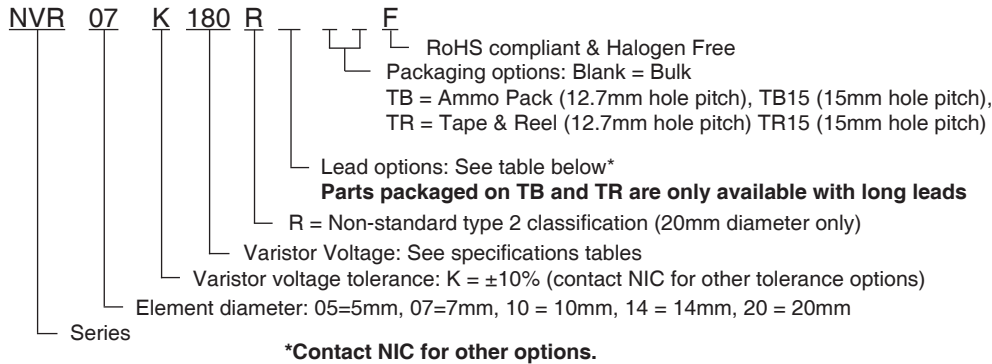

Lead Configuration Code	Description
S	Straight with long leads
G	Y Crimp with long leads
C ± --	Cut Leads (Bulk only) C.20 = Cut 0.20" lead length ±0.02" C.25 = Cut 0.25" lead length ±0.02"

NVR LEAD STYLES

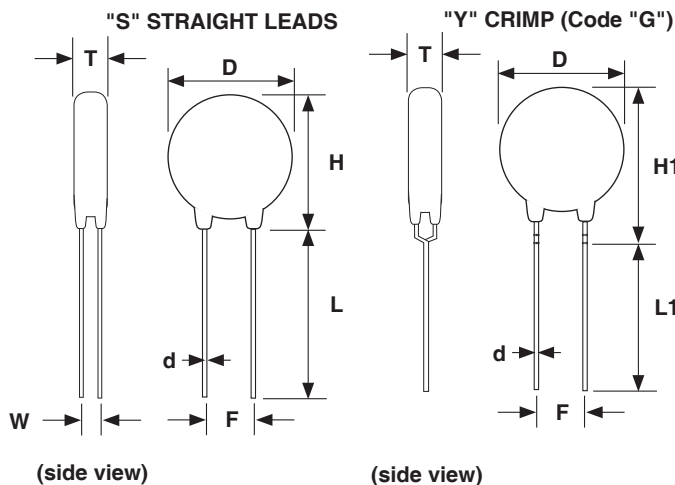

MARKING

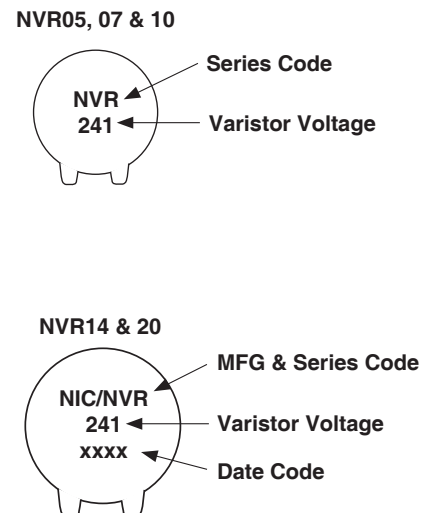

NVR05 SPECIFICATIONS

Part Number	Varistor Voltage (1mA DC)	Max. Operating Voltage		Max. Clamping Voltage (8/20 μ S)		Max. Surge Current (8/20 μ S)	Rated Power	Max. Energy (10/1000 μ s)	Ref. Capacitance @ 1KHz	W \pm 1.0	UL1449 3rd Rev. SPD Appl.
	Vdc (1mA)	Vac (rms)	Vdc	Ip (A)	Vp	I max. (A)	Watts	Joules	pF	mm	
NVR05K180S__F	18 (16~20)	11	14	1	40	100	0.01	0.4	1300	1.5	Other Applications (See page 8, table 2)
NVR05K220S__F	22 (20~24)	14	18	1	48	100	0.01	0.5	1000	1.5	
NVR05K270S__F	27 (24~30)	17	22	1	60	100	0.01	0.6	850	1.5	
NVR05K330S__F	33 (30~36)	20	26	1	73	100	0.01	0.8	700	1.5	
NVR05K390S__F	39 (35~43)	25	31	1	86	100	0.01	0.9	600	1.5	
NVR05K470S__F	47 (42~52)	30	38	1	104	100	0.01	1.1	500	1.5	
NVR05K560S__F	56 (50~62)	35	45	1	123	100	0.01	1.3	400	1.5	
NVR05K680S__F	68 (61~75)	40	56	1	150	100	0.01	1.6	330	1.5	
NVR05K820S__F	82 (74~90)	50	65	5	145	400	0.1	2.5	250	1.5	
NVR05K101S__F	100 (90~110)	60	85	5	175	400	0.1	3	230	1.6	
NVR05K121S__F	120 (108~132)	75	100	5	210	400	0.1	4	210	1.8	
NVR05K151S__F	150 (135~165)	95	125	5	260	400	0.1	4.8	190	1.6	
NVR05K181S__F	180 (162~198)	115	150	5	315	400	0.1	5.9	70	1.4	
NVR05K201S__F	200 (180~220)	130	170	5	355	400	0.1	6.5	65	1.5	
NVR05K221S__F	220 (198~242)	140	180	5	380	400	0.1	7	60	1.5	
NVR05K241S__F	240 (216~264)	150	200	5	415	400	0.1	8	55	1.6	
NVR05K271S__F	270 (243~297)	175	225	5	475	400	0.1	8.5	50	1.7	
NVR05K301S__F	300 (270~330)	195	250	5	525	400	0.1	8.5	50	1.9	
NVR05K331S__F	330 (297~363)	215	275	5	585	400	0.1	9.2	45	2.0	
NVR05K361S__F	360 (324~396)	230	300	5	620	400	0.1	10	45	2.1	
NVR05K391S__F	390 (351~429)	250	320	5	675	400	0.1	12	40	2.3	
NVR05K431S__F	430 (387~473)	275	350	5	745	400	0.1	13	35	2.3	
NVR05K471S__F	470 (423~517)	300	385	5	810	400	0.1	15	30	2.4	



NVR07 SPECIFICATIONS

Part Number	Varistor Voltage (1mA DC)	Max. Operating Voltage		Max. Clamping Voltage (8/20 μ S)		Max. Surge Current (8/20 μ S)	Rated Power	Max. Energy (10/1000 μ s)	Ref. Capacitance @ 1KHz	W \pm 1.0	UL1449 3rd Rev. SPD Appl.
	V (1mA)	Vac (rms)	Vdc	I _p (A)	V _p	I max. (A)	Watts	Joules	pF	mm	
NVR07K180S__F	18 (16~20)	11	14	2.5	36	250	0.02	0.9	2400	1.3	Other Applications (See page 8, table 2)
NVR07K220S__F	22 (20~24)	14	18	2.5	43	250	0.02	1.1	2000	1.4	
NVR07K270S__F	27 (24~30)	17	22	2.5	53	250	0.02	1.4	1600	1.5	
NVR07K330S__F	33 (30~36)	20	26	2.5	65	250	0.02	1.7	1300	1.7	
NVR07K390S__F	39 (35~43)	25	31	2.5	77	250	0.02	2.1	1200	1.8	
NVR07K470S__F	47 (42~52)	30	38	2.5	93	250	0.02	2.5	1100	1.9	
NVR07K560S__F	56 (50~62)	35	45	2.5	110	250	0.02	3.1	1000	2.0	
NVR07K680S__F	68 (61~75)	40	56	2.5	135	250	0.02	3.6	850	2.1	
NVR07K820S__F	82 (74~90)	50	65	10	135	1200	0.25	5.5	460	1.5	
NVR07K101S__F	100 (90~110)	60	85	10	165	1200	0.25	6.5	420	1.6	
NVR07K121S__F	120 (108~132)	75	100	10	200	1200	0.25	7.8	380	1.8	
NVR07K151S__F	150 (135~165)	95	125	10	250	1200	0.25	9.7	350	1.6	
NVR07K181S__F	180 (162~198)	115	150	10	300	1200	0.25	11.7	155	1.4	
NVR07K201S__F	200 (180~220)	130	170	10	340	1200	0.25	13	140	1.5	
NVR07K221S__F	220 (198~242)	140	180	10	360	1200	0.25	14	130	1.5	
NVR07K241S__F	240 (216~264)	150	200	10	395	1200	0.25	15	120	1.6	
NVR07K271S__F	270 (243~297)	175	225	10	455	1200	0.25	18	110	1.7	
NVR07K301S__F	300 (270~330)	195	250	10	500	1200	0.25	21	105	1.9	
NVR07K331S__F	330 (297~363)	215	275	10	550	1200	0.25	23	100	2.0	
NVR07K361S__F	360 (324~396)	230	300	10	595	1200	0.25	25	95	2.1	
NVR07K391S__F	390 (351~429)	250	320	10	650	1200	0.25	25	85	2.3	
NVR07K431S__F	430 (387~473)	275	350	10	710	1200	0.25	28	80	2.3	
NVR07K471S__F	470 (423~517)	300	385	10	775	1200	0.25	30	70	2.4	
NVR07K511S__F	510 (459~561)	320	410	10	845	1200	0.25	33	65	2.6	
NVR07K561S__F	560 (504~616)	350	450	10	930	1200	0.25	33	60	2.8	
NVR07K621S__F	620 (558~682)	395	510	10	1020	1200	0.25	35	55	3.0	
NVR07K681S__F	680 (612~748)	420	560	10	1120	1200	0.25	35	50	3.2	
NVR07K751S__F	750 (675~825)	465	615	10	1235	1200	0.25	38	45	3.5	
NVR07K821S__F	820 (738~902)	510	670	10	1355	1200	0.25	42	40	3.2	



NVR10 SPECIFICATIONS

Part Number	Varistor Voltage (1mA DC)	Max. Operating Voltage		Max. Clamping Voltage (8/20 μ S)		Max. Surge Current (8/20 μ S)	Rated Power	Max. Energy (10/1000 μ s)	Ref. Capacitance @ 1KHz	W \pm 1.0	UL1449 3rd Rev. SPD Appl.
	V (1mA)	V _{ac} (rms)	V _{dc}	I _p (A)	V _p	I max. (A)	Watts	Joules	pF	mm	
NVR10K180S__F	18 (16~20)	11	14	5	36	500	0.05	2.1	4500	1.3	Other Applications (See page 8, table 2)
NVR10K220S__F	22 (20~24)	14	18	5	43	500	0.05	2.5	3500	1.4	
NVR10K270S__F	27 (24~30)	17	22	5	53	500	0.05	3	3000	1.5	
NVR10K330S__F	33 (30~36)	20	26	5	65	500	0.05	4	2500	1.7	
NVR10K390S__F	39 (35~43)	25	31	5	77	500	0.05	4.6	2000	1.8	
NVR10K470S__F	47 (42~52)	30	38	5	93	500	0.05	5.5	1500	1.8	
NVR10K560S__F	56 (50~62)	35	45	5	110	500	0.05	7	1350	1.9	
NVR10K680S__F	68 (61~75)	40	56	5	135	500	0.05	8.2	1250	2.2	
NVR10K820S__F	82 (74~90)	50	65	25	135	2500	0.4	12	1000	1.6	
NVR10K101S__F	100 (90~110)	60	85	25	165	2500	0.4	15	920	1.8	
NVR10K121S__F	120 (108~132)	75	100	25	200	2500	0.4	18	830	2.0	
NVR10K151S__F	150 (135~165)	95	125	25	250	2500	0.4	22	760	1.8	
NVR10K181S__F	180 (162~198)	115	150	25	300	2500	0.4	27	310	1.6	
NVR10K201S__F	200 (180~220)	130	170	25	340	2500	0.4	30	290	1.7	
NVR10K221S__F	220 (198~242)	140	180	25	360	2500	0.4	32	270	1.7	
NVR10K241S__F	240 (216~264)	150	200	25	395	2500	0.4	35	240	1.8	
NVR10K271S__F	270 (243~297)	175	225	25	455	2500	0.4	40	230	1.9	
NVR10K301S__F	300 (270~330)	195	250	25	500	2500	0.4	40	210	2.1	
NVR10K331S__F	330 (297~363)	215	275	25	550	2500	0.4	43	200	2.2	
NVR10K361S__F	360 (324~396)	230	300	25	595	2500	0.4	47	190	2.3	
NVR10K391S__F	390 (351~429)	250	320	25	650	2500	0.4	60	175	2.5	
NVR10K431S__F	430 (387~473)	275	350	25	710	2500	0.4	65	160	2.5	
NVR10K471S__F	470 (423~517)	300	385	25	775	2500	0.4	70	150	2.6	
NVR10K511S__F	510 (459~561)	320	410	25	845	2500	0.4	70	130	2.8	
NVR10K561S__F	560 (504~616)	350	450	25	930	2500	0.4	70	120	3.0	
NVR10K621S__F	620 (558~682)	395	510	25	1020	2500	0.4	70	110	3.2	
NVR10K681S__F	680 (612~748)	420	560	25	1120	2500	0.4	70	100	3.4	
NVR10K751S__F	750 (675~825)	465	615	25	1235	2500	0.4	75	90	3.7	
NVR10K821S__F	820 (738~902)	510	670	25	1355	2500	0.4	85	80	3.4	
NVR10K911S__F	910 (819~1001)	550	745	25	1500	2500	0.4	93	70	3.7	
NVR10K102S__F	1000 (900~1100)	625	825	25	1650	2500	0.4	102	65	4.0	
NVR10K112S__F	1100 (990~1210)	680	895	25	1815	2500	0.4	115	60	4.3	
NVR10K122S__F	1200 (1080~1320)	725	975	25	1980	2500	0.4	125	55	5.2	
NVR10K142S__F	1400 (1260~1540)	820	1140	25	2300	2500	0.4	145	45	6.0	
NVR10K162S__F	1600 (1440~1760)	910	1300	25	2630	2500	0.4	165	40	6.7	
NVR10K182S__F	1800 (1620~1980)	1000	1465	25	2950	2500	0.4	185	35	7.4	



NVR14 SPECIFICATIONS

Part Number	Varistor Voltage (1mA DC)	Max. Operating Voltage		Max. Clamping Voltage (8/20 μ S)		Max. Surge Current (8/20 μ S)	Rated Power	Max. Energy (10/1000 μ s)	Ref. Capacitance @ 1KHz	W \pm 1.0	UL1449 3rd Rev. SPD Appl.
	V (1mA)	Vac (rms)	Vdc	Ip (A)	Vp	I max. (A)	Watts	Joules	pF	mm	
NVR14K180S__F	18(16-20)	11	14	10	36	1000	0.1	4	10000	1.3	Other Applications (See page 8, table 2)
NVR14K220S__F	22(20-24)	14	18	10	43	1000	0.1	5	8500	1.4	
NVR14K270S__F	27(24-30)	17	22	10	53	1000	0.1	6	7000	1.5	
NVR14K330S__F	33(30-36)	20	26	10	65	1000	0.1	7.5	6000	1.7	
NVR14K390S__F	39(35-43)	25	31	10	77	1000	0.1	8.6	4800	1.8	
NVR14K470S__F	47(42-52)	30	38	10	93	1000	0.1	10	3800	1.8	
NVR14K560S__F	56(50-62)	35	45	10	110	1000	0.1	11	3300	1.9	
NVR14K680S__F	68(61-75)	40	56	10	135	1000	0.1	14	2700	2.2	
NVR14K820S__F	82(74-90)	50	65	50	135	4500	0.6	22	2100	1.6	for SPD Type 3 Appl. (See page 8, tables 1 & 2)
NVR14K101S__F	100(90-110)	60	85	50	165	4500	0.6	28	1900	1.8	
NVR14K121S__F	120(108-132)	75	100	50	200	4500	0.6	32	1700	2.0	
NVR14K151S__F	150(135-165)	95	125	50	250	4500	0.6	40	940	1.8	
NVR14K181S__F	180(162-198)	115	150	50	300	4500	0.6	52	800	1.6	
NVR14K201S__F	200(180-220)	130	170	50	340	4500	0.6	57	700	1.7	
NVR14K221S__F	220(198-242)	140	180	50	360	4500	0.6	60	640	1.7	
NVR14K241S__F	240(216-264)	150	200	50	395	4500	0.6	63	580	1.8	
NVR14K271S__F	270(243-297)	175	225	50	455	4500	0.6	70	520	1.9	
NVR14K301S__F	300(270-330)	195	250	50	500	4500	0.6	78	480	2.1	
NVR14K331S__F	330(297-363)	215	275	50	550	4500	0.6	85	450	2.2	
NVR14K361S__F	360(324-396)	230	300	50	595	4500	0.6	93	430	2.3	
NVR14K391S__F	390(351-429)	250	320	50	650	4500	0.6	100	390	2.5	
NVR14K431S__F	430(387-473)	275	350	50	710	4500	0.6	115	370	2.5	
NVR14K471S__F	470(423-517)	300	385	50	775	4500	0.6	125	320	2.6	
NVR14K511S__F	510(459-561)	320	410	50	845	4500	0.6	125	290	2.8	
NVR14K561S__F	560(504-616)	350	450	50	930	4500	0.6	125	260	3.0	
NVR14K621S__F	620(558-682)	395	510	50	1020	4500	0.6	125	240	3.2	
NVR14K681S__F	680(612-748)	420	560	50	1120	4500	0.6	130	230	3.4	
NVR14K751S__F	750(675-825)	465	615	50	1235	4500	0.6	143	220	3.7	
NVR14K821S__F	820(738-902)	510	670	50	1355	4500	0.6	157	180	3.4	
NVR14K911S__F	910(819-1001)	550	745	50	1500	4500	0.6	175	170	3.7	
NVR14K102S__F	1000(900-1100)	625	825	50	1650	4500	0.6	190	150	4.0	
NVR14K112S__F	1100(990-1210)	680	895	50	1815	4500	0.6	213	140	4.3	
NVR14K122S__F	1200 (1080-1320)	725	975	50	1980	4500	0.6	230	130	5.2	
NVR14K142S__F	1400 (1260-1540)	820	1140	50	2300	4500	0.6	250	110	6.0	
NVR14K162S__F	1600 (1440-1760)	910	1300	50	2630	4500	0.6	315	95	6.7	
NVR14K182S__F	1800 (1620-1980)	1000	1465	50	2950	4500	0.6	354	85	7.4	



NVR20 SPECIFICATIONS (SPD TYPE 3 APPLICATIONS)

Part Number	Varistor Voltage (1mA DC)	Max. Operating Voltage		Max. Clamping Voltage (8/20 μ S)		Max. Surge Current (8/20 μ S)	Rated Power	Max. Energy (10/1000 μ s)	Ref. Capacitance @ 1KHz	W \pm 1.0	UL1449 3rd Rev. SPD Appl.
	V (1mA)	Vac (rms)	Vdc	Ip (A)	Vp	I max. (A)	Watts	Joules	pF	mm	
NVR20K180S__F	18(16-20)	11	14	20	36	2000	0.2	11	19000	1.3	for SPD Type 3 Appl. (See page 8, tables 1 & 2)
NVR20K220S__F	22(20-24)	14	18	20	43	2000	0.2	14	16000	1.4	
NVR20K270S__F	27(24-30)	17	22	20	53	2000	0.2	18	14500	1.5	
NVR20K330S__F	33(30-36)	20	26	20	65	2000	0.2	23	13000	1.7	
NVR20K390S__F	39(35-43)	25	31	20	77	2000	0.2	26	12000	1.7	
NVR20K470S__F	47(42-52)	30	38	20	93	2000	0.2	33	11000	1.8	
NVR20K560S__F	56(50-62)	35	45	20	110	2000	0.2	41	9000	2.0	
NVR20K680S__F	68(61-75)	40	56	20	135	2000	0.2	46	7500	2.2	
NVR20K820S__F	82(74-90)	50	65	100	135	6500	1	48	4800	1.8	
NVR20K101S__F	100(90-110)	60	85	100	165	6500	1	51	3900	2.0	
NVR20K121S__F	120(108-132)	75	100	100	200	6500	1	55	3300	2.2	
NVR20K151S__F	150(135-165)	95	125	100	250	6500	1	70	1950	2.0	
NVR20K181S__F	180(162-198)	115	150	100	300	6500	1	84	1620	1.8	
NVR20K201S__F	200(180-220)	130	170	100	340	6500	1	95	1460	1.9	
NVR20K221S__F	220(198-242)	140	180	100	360	6500	1	100	1320	1.9	
NVR20K241S__F	240(216-264)	150	200	100	395	6500	1	108	1200	2.0	
NVR20K271S__F	270(243-297)	175	225	100	455	6500	1	127	1100	2.1	
NVR20K301S__F	300(270-330)	195	250	100	500	6500	1	136	1000	2.3	
NVR20K331S__F	330(297-363)	215	275	100	550	6500	1	150	950	2.4	
NVR20K361S__F	360(324-396)	230	300	100	595	6500	1	163	900	2.5	
NVR20K391S__F	390(351-429)	250	320	100	650	6500	1	180	800	2.7	
NVR20K431S__F	430(387-473)	275	350	100	710	6500	1	190	700	2.7	
NVR20K471S__F	470(423-517)	300	385	100	775	6500	1	220	620	2.8	
NVR20K511S__F	510(459-561)	320	410	100	845	6500	1	220	530	3.0	
NVR20K561S__F	560(504-616)	350	450	100	930	6500	1	220	480	3.2	
NVR20K621S__F	620(558-682)	395	510	100	1020	6500	1	220	450	3.4	
NVR20K681S__F	680(612-748)	420	560	100	1120	6500	1	230	440	3.6	
NVR20K751S__F	750(675-825)	465	615	100	1235	6500	1	255	420	3.9	
NVR20K821S__F	820(738-902)	510	670	100	1355	6500	1	282	390	3.6	
NVR20K911S__F	910(819-1001)	550	745	100	1500	6500	1	310	360	3.9	
NVR20K102S__F	1000(900-1100)	625	825	100	1650	6500	1	342	330	4.2	
NVR20K112S__F	1100(990-1210)	680	895	100	1815	6500	1	383	310	4.5	
NVR20K122S__F	1200 (1080-1320)	725	975	100	1980	6500	1	415	290	5.4	
NVR20K142S__F	1400 (1260-1540)	820	1140	100	2300	6500	1	480	250	6.2	
NVR20K162S__F	1600 (1440-1760)	910	1300	100	2630	6500	1	550	220	6.9	
NVR20K182S__F	1800 (1620-1980)	1000	1465	100	2950	6500	1	620	195	7.6	



NVR20 SPECIFICATIONS (SPD TYPE 2 APPLICATIONS)

Part Number	Varistor Voltage (1mA DC)	Max. Operating Voltage		Max. Clamping Voltage (8/20 μ S)		Max. Surge Current (8/20 μ S)	Nominal Discharge Current (8/20 μ S) ^{*1}	Rated Power	Max. Energy (10/1000 μ s)	Ref. Cap. @ 1KHz	W \pm 1.0	UL1449 3rd Rev. SPD Appl.
	V (1mA)	Vac (rms)	Vdc	I _p (A)	V _p	I max. (A)	I (A)	Watts	Joules	pF	mm	
NVR20K820RS__F	82(74~90)	50	65	100	135	6500	3000	1	48	4800	1.8	for SPD Type 2 Appl. (See page 8, table 1)
NVR20K101RS__F	100(90~110)	60	85	100	165	6500	3000	1	51	3900	2.0	
NVR20K121RS__F	120(108~132)	75	100	100	200	6500	3000	1	55	3300	2.2	
NVR20K151RS__F	150(135~165)	95	125	100	250	6500	3000	1	70	1950	2.0	
NVR20K181RS__F	180(162~198)	115	150	100	300	6500	3000	1	84	1620	1.8	
NVR20K201RS__F	200(180~220)	130	170	100	340	6500	3000	1	95	1460	1.9	
NVR20K221RS__F	220(198~242)	140	180	100	360	6500	3000	1	100	1320	1.9	
NVR20K241RS__F	240(216~264)	150	200	100	395	6500	3000	1	108	1200	2.0	
NVR20K271RS__F	270(243~297)	175	225	100	455	6500	3000	1	127	1100	2.1	
NVR20K301RS__F	300(270~330)	195	250	100	500	6500	3000	1	136	1000	2.3	
NVR20K331RS__F	330(297~363)	215	275	100	550	6500	3000	1	150	950	2.4	
NVR20K361RS__F	360(324~396)	230	300	100	595	6500	3000	1	163	900	2.5	
NVR20K391RS__F	390(351~429)	250	320	100	650	6500	3000	1	180	800	2.7	
NVR20K431RS__F	430(387~473)	275	350	100	710	6500	3000	1	190	700	2.7	
NVR20K471RS__F	470(423~517)	300	385	100	775	6500	3000	1	220	620	2.8	
NVR20K511RS__F	510(459~561)	320	410	100	845	6500	3000	1	220	530	3.0	
NVR20K561RS__F	560(504~616)	350	450	100	930	6500	3000	1	220	480	3.2	
NVR20K621RS__F	620(558~682)	395	510	100	1020	6500	3000	1	220	450	3.4	
NVR20K681RS__F	680(612~748)	420	560	100	1120	6500	3000	1	230	440	3.6	
NVR20K751RS__F	750(675~825)	465	615	100	1235	6500	3000	1	255	420	3.9	
NVR20K821RS__F	820(738~902)	510	670	100	1355	6500	3000	1	282	390	3.6	
NVR20K911RS__F	910(819~1001)	550	745	100	1500	6500	3000	1	310	360	3.9	
NVR20K102RS__F	1000(900~1100)	625	825	100	1650	6500	3000	1	342	330	4.2	
NVR20K112RS__F	1100(990~1210)	680	895	100	1815	6500	3000	1	383	310	4.5	
NVR20K122RS__F	1200 (1080-1320)	725	975	100	1980	6500	3000	1	415	290	5.4	
NVR20K142RS__F	1400 (1260-1540)	820	1140	100	2300	6500	3000	1	480	250	6.2	
NVR20K162RS__F	1600 (1440-1760)	910	1300	100	2630	6500	3000	1	550	220	6.9	
NVR20K182RS__F	1800 (1620-1980)	1000	1465	100	2950	6500	3000	1	620	195	7.6	

*1 - Nominal discharge current is the specification defined in UL1449 3rd edition and uses 8/20 μ A current waveform to test the varistor.



TABLE 1 - DEFINITION OF UL SPD APPLICATION TYPES

Type	Description
Type 2	Permanently connected SPDs intended for installation on the load side of the service equipment overcurrent device; including SPDs located at the branch panel.
Type 3	Point of utilization SPDs, installed at a minimum conductor length of 10 meters (30 feet) from the electrical service panel to the point of utilization, for example cord connected, direct plug-in, receptacle type and SPDs installed at the utilization equipment being protected. See marking in 64.2. The distance (10 meters) is exclusive of conductors provided with or used to attach SPDs.

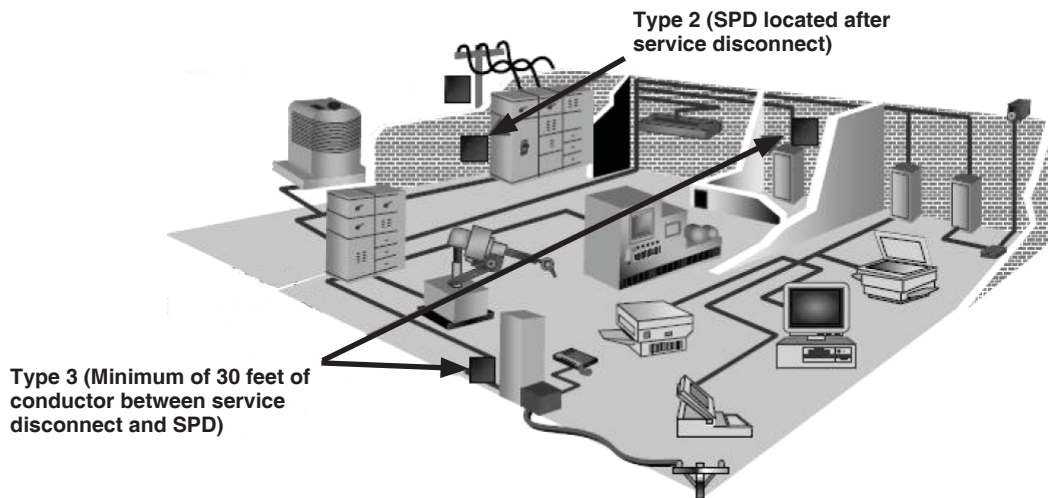

EXAMPLES OF SPD APPLICATION TYPES

Type 2 applications include indoor AC applications located after the service disconnection.

Type 3 applications include SPDs that are cord-connected, plugged directly into the socket or integrated in the outlet. They must be installed a minimum of 10 meters (30 feet) from the electrical service panel. An example would be a home appliance that is installed beyond 10 meters (30 feet) from the electrical service panel, and it uses varistors in power in for surge protection, the Varistor should meet SPD Type 3.

TABLE 2 - Other applications as described in the table below:

Intended End-Use (SPD Type)	NVR Sizes (Values)	Part Diameter	Voltage Protective Rating Test & Waveform	
			Waveform Peak Voltage (Vp)	Peak Current (Ap)
Other Applications	NVR05 (180 ~ 680)	5mm	600V (1.2x50uS*)	50V (8x20uS**)
	NVR05 (820 ~ 471) NVR10 (180 ~ 680)	5mm 10mm	3000V (1.2x50uS*)	250V (8x20uS**)
	NVR7 (180 ~ 680)	7mm	1200V (1.2x50uS*)	100V (8x20uS**)
	NVR7 (820 ~ 821) NVR14 (180 ~ 680)	7mm 14mm	1000V (1.2x50uS*)	500V (8x20uS**)
	NVR7 (820 ~ 821) NVR14 (180 ~ 680)	7mm 14mm	2000V (1.2x50uS*)	1000V (8x20uS**)
For SPD Type 3	NVR14 (820 ~ 182) NVR20 (820 ~ 182)	14mm 20mm	6000V (1.2x50uS*)	3000V (8x20uS**)
Notes:	* 1.2x50uS - 1.2uSec. rise time and 50uSec fall time ** 8x20uS - 8uSec. rise time and 20uSec fall time Industry standard benchmark to quantify the component's response to a typically fast transient			

Max. Leakage Current and Max. Clamping Voltage Curves (NVR05 180 to 680)

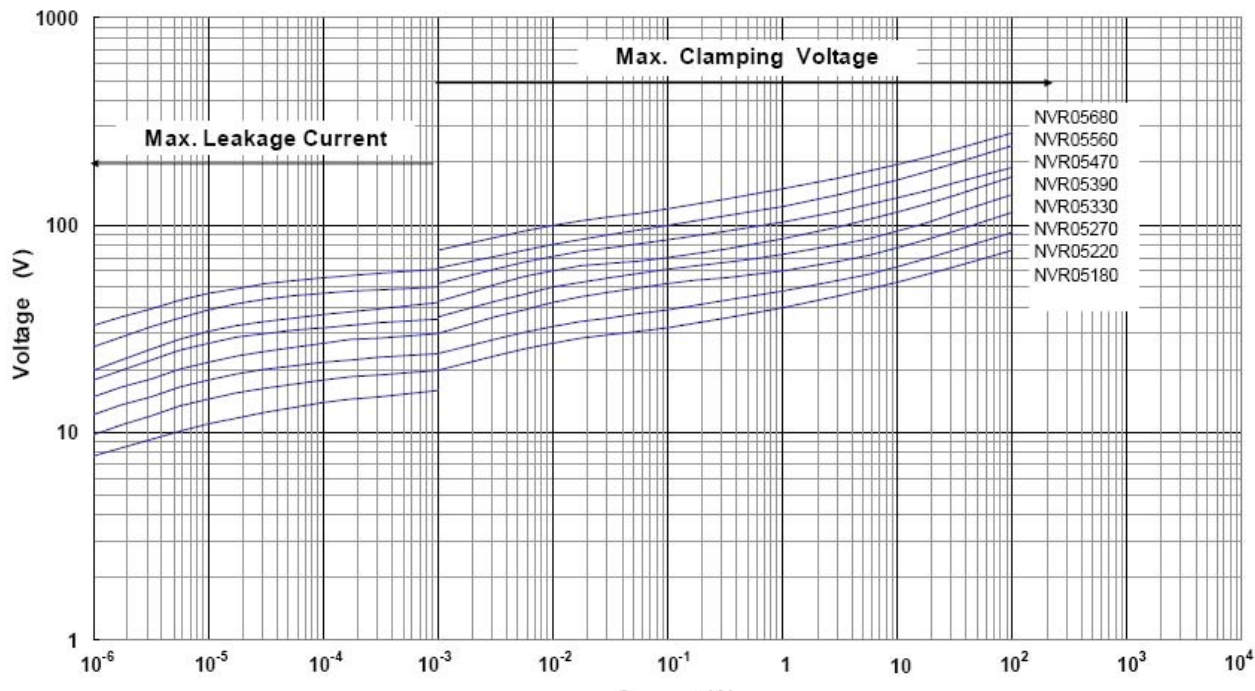

Max. Leakage Current and Max. Clamping Voltage Curves (NVR05 820 to 751)

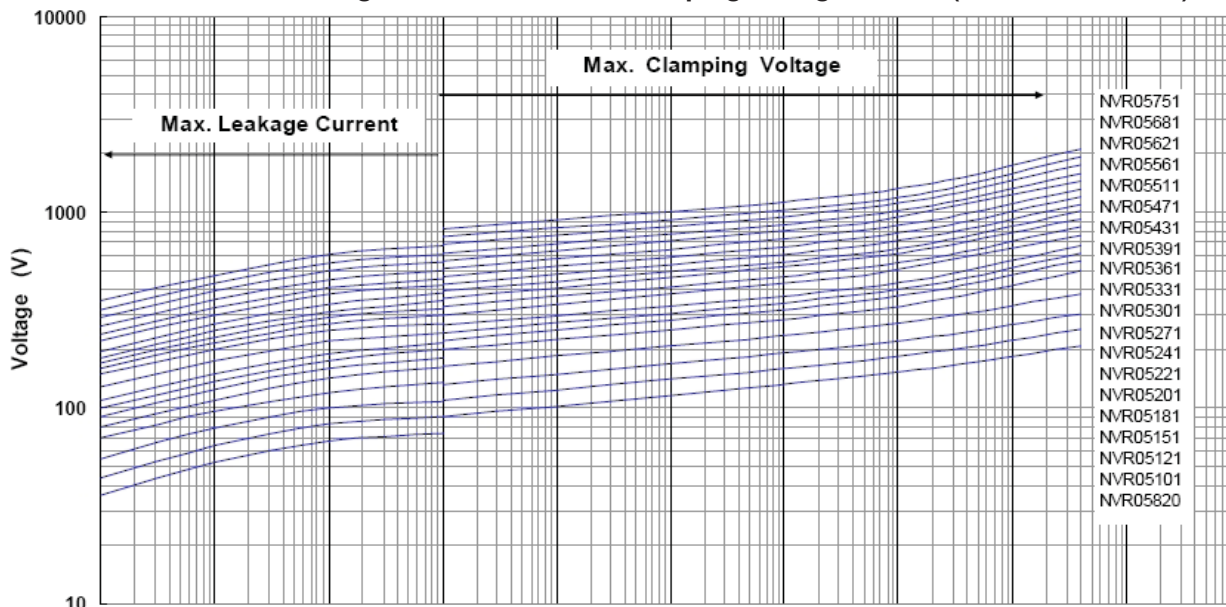

Max. Leakage Current and Max. Clamping Voltage Curves (NVR07 180 to 680)

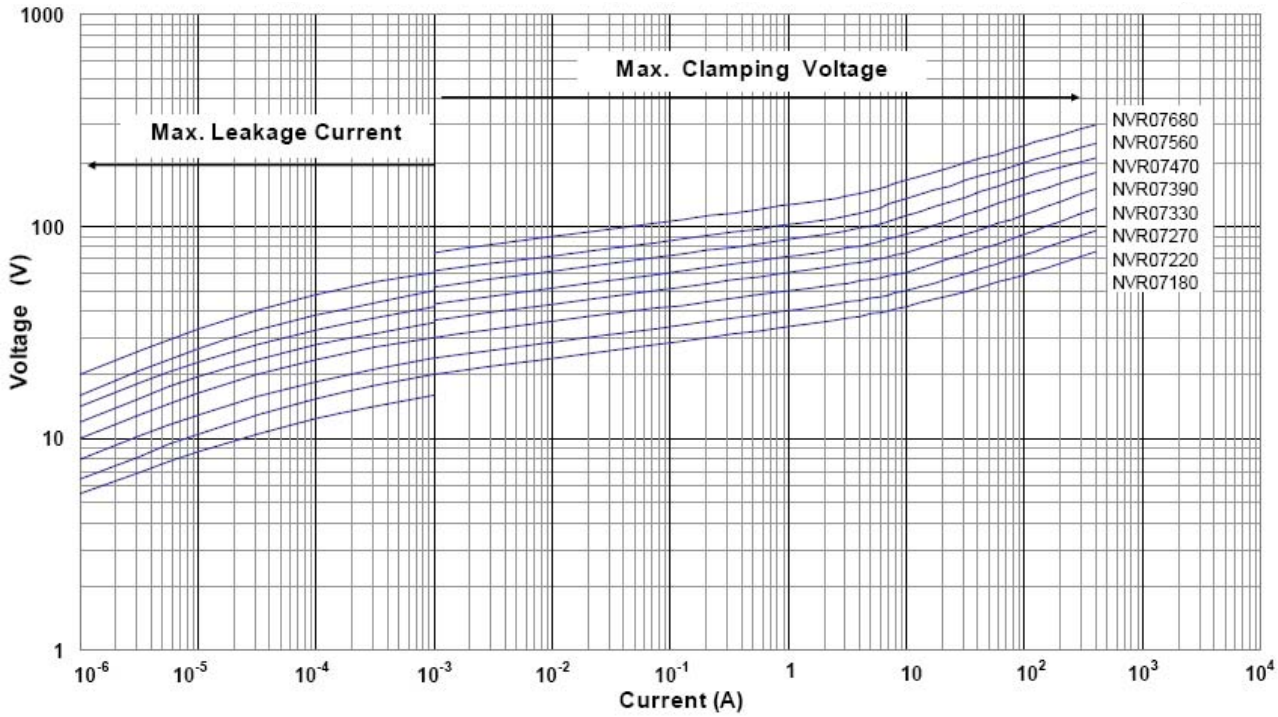

Max. Leakage Current and Max. Clamping Voltage Curves (NVR07 820 to 471)

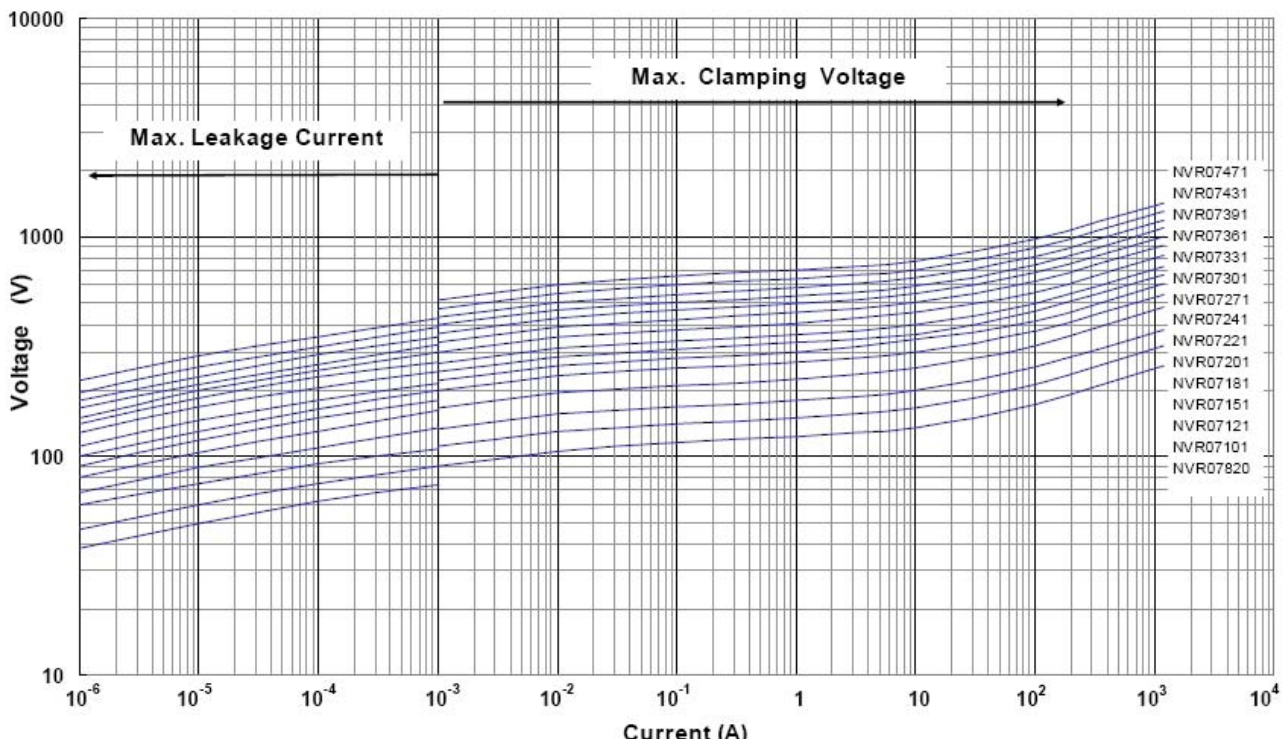

Max. Leakage Current and Max. Clamping Voltage Curves (NVR07 511 to 821)

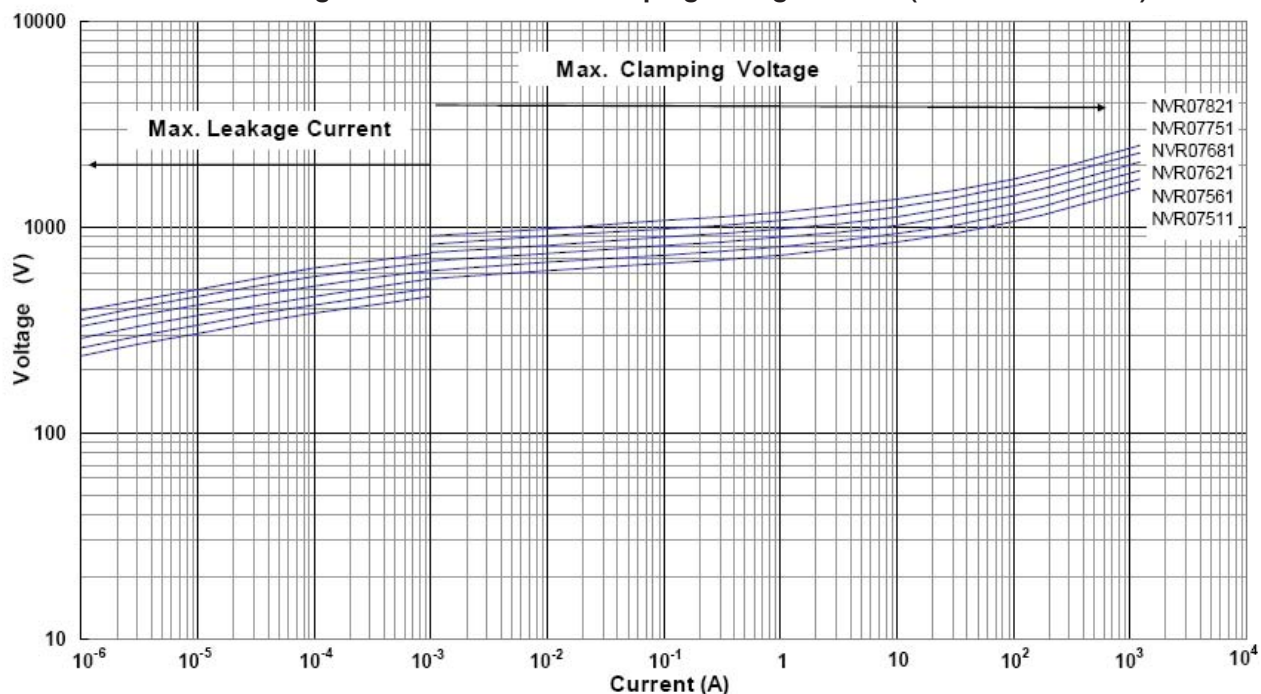

Max. Leakage Current and Max. Clamping Voltage Curves (NVR10 180 to 680)

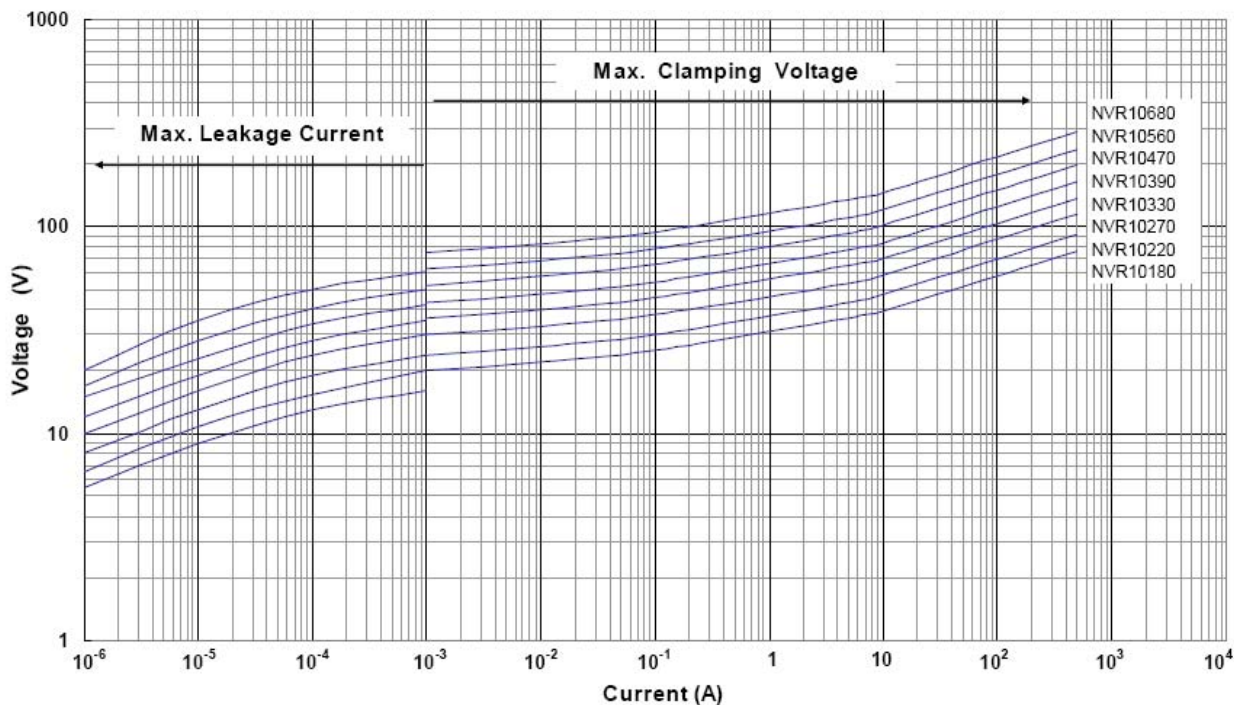

Max. Leakage Current and Max. Clamping Voltage Curves (NVR10 820 to 471)

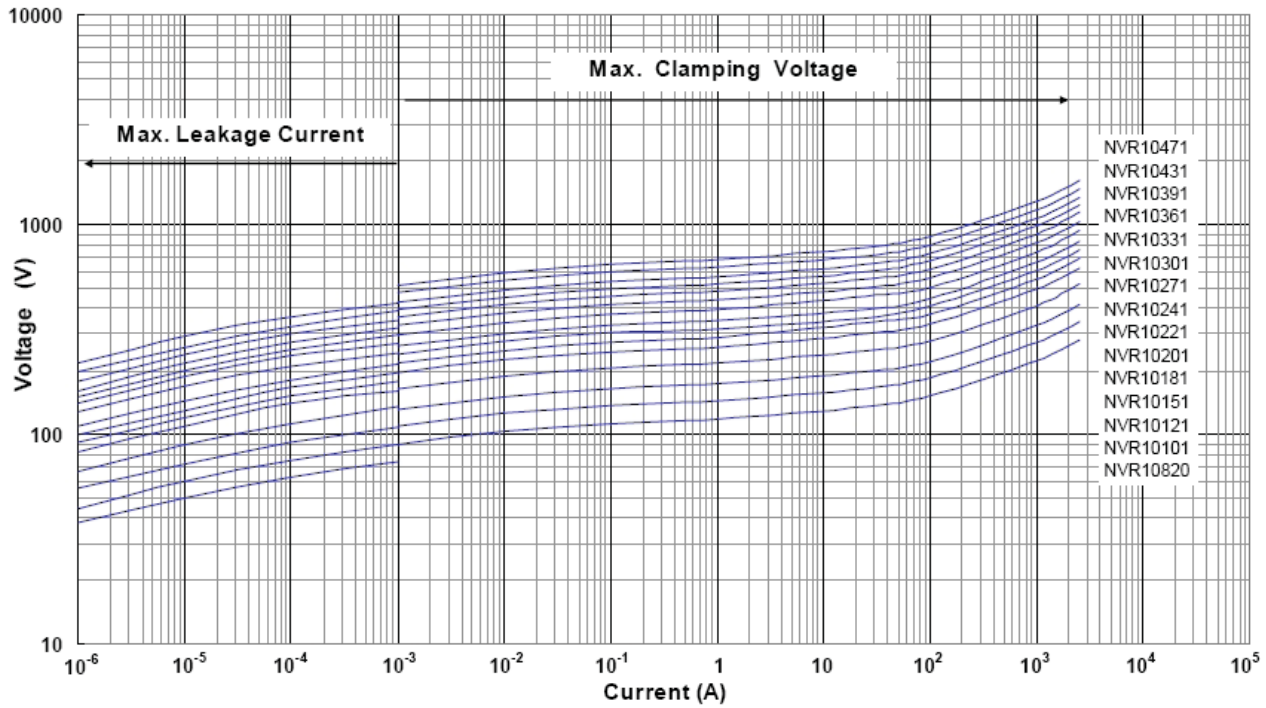

Max. Leakage Current and Max. Clamping Voltage Curves (NVR10 511 to 182)

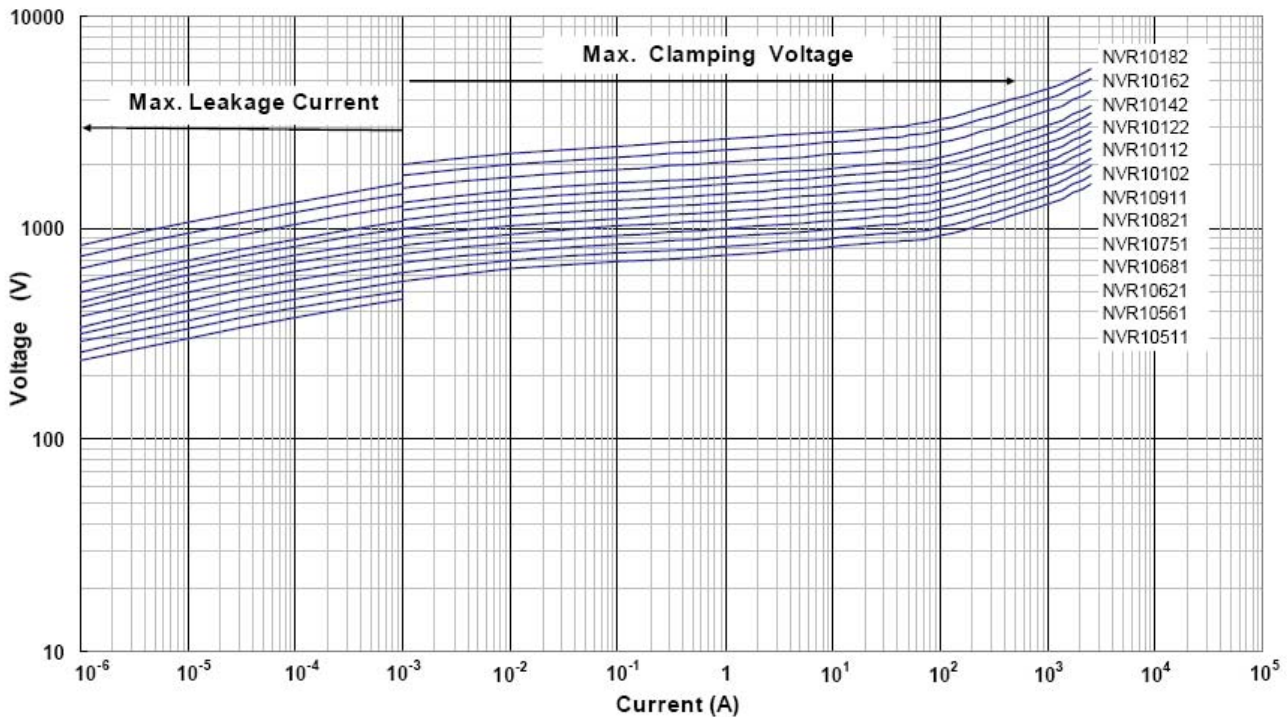

Max. Leakage Current and Max. Clamping Voltage Curves (NVR14 180 to 680)

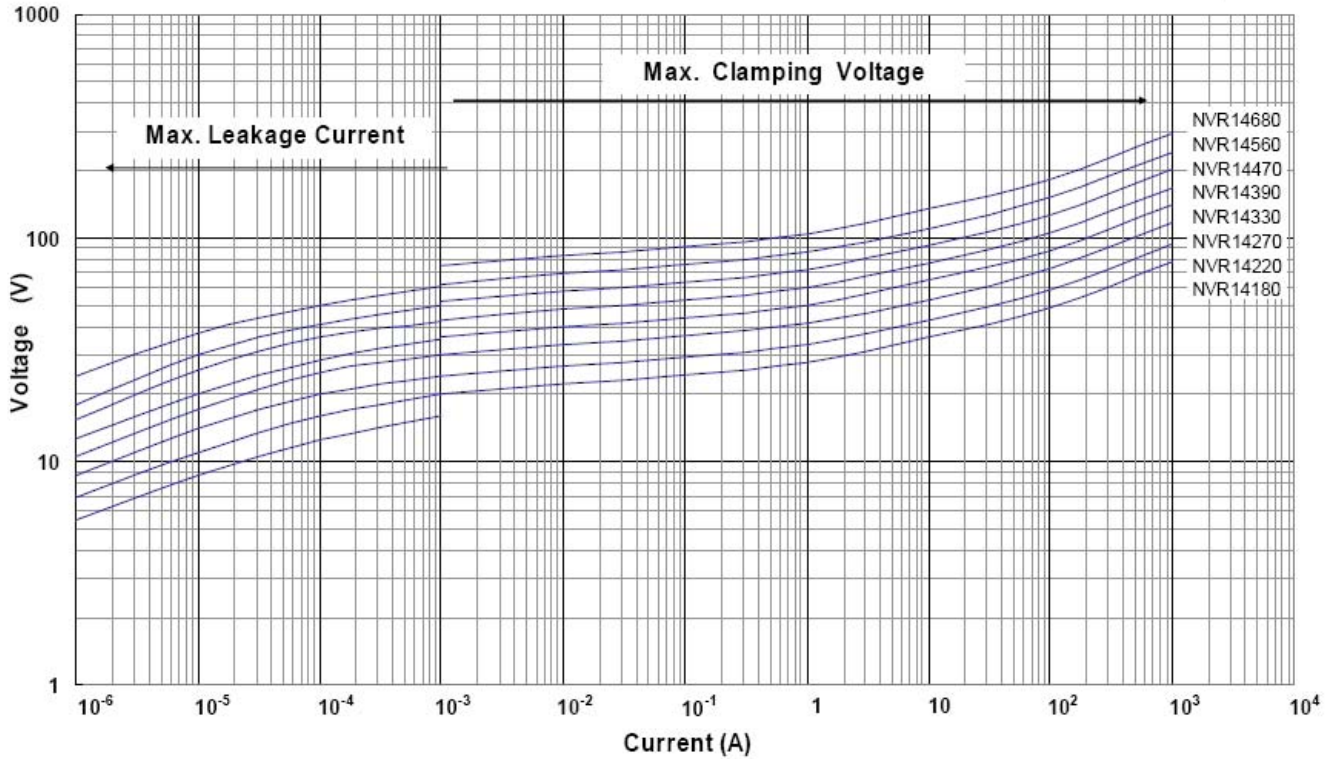

Max. Leakage Current and Max. Clamping Voltage Curves (NVR14 820 to 471)

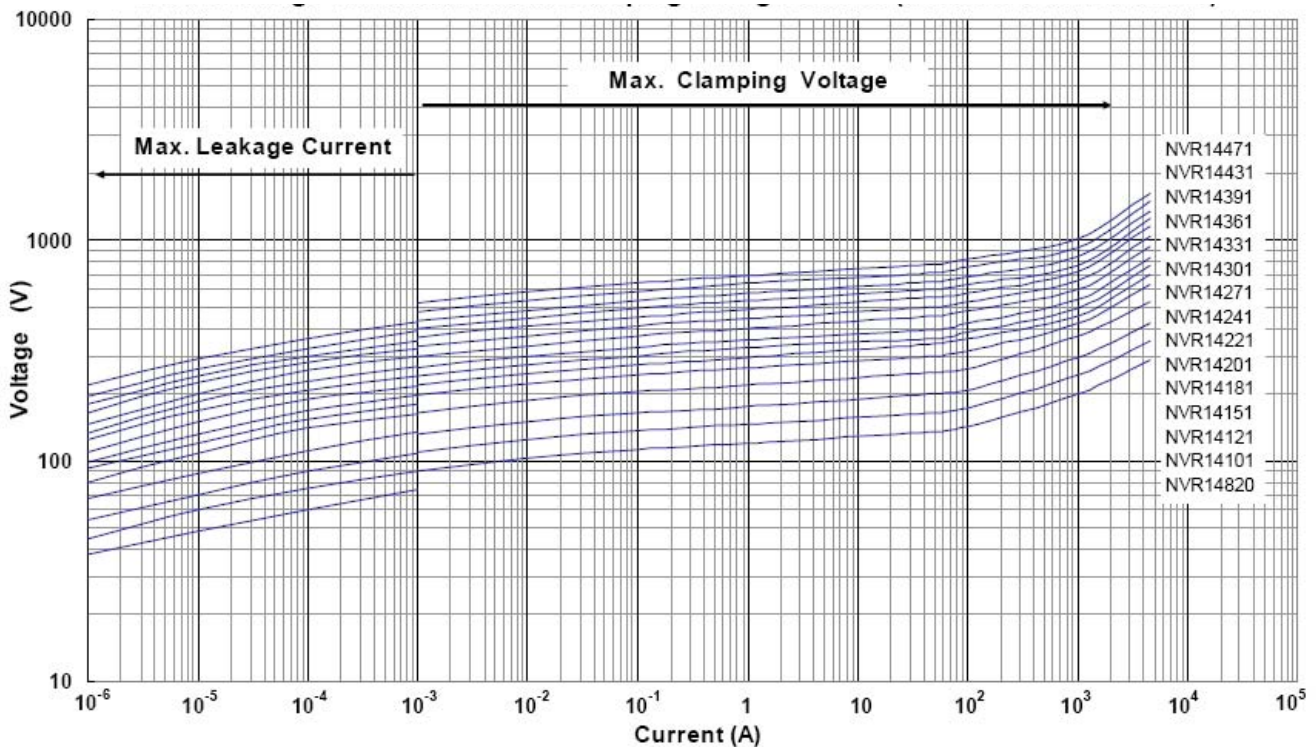

Max. Leakage Current and Max. Clamping Voltage Curves (NVR14 511 to 182)

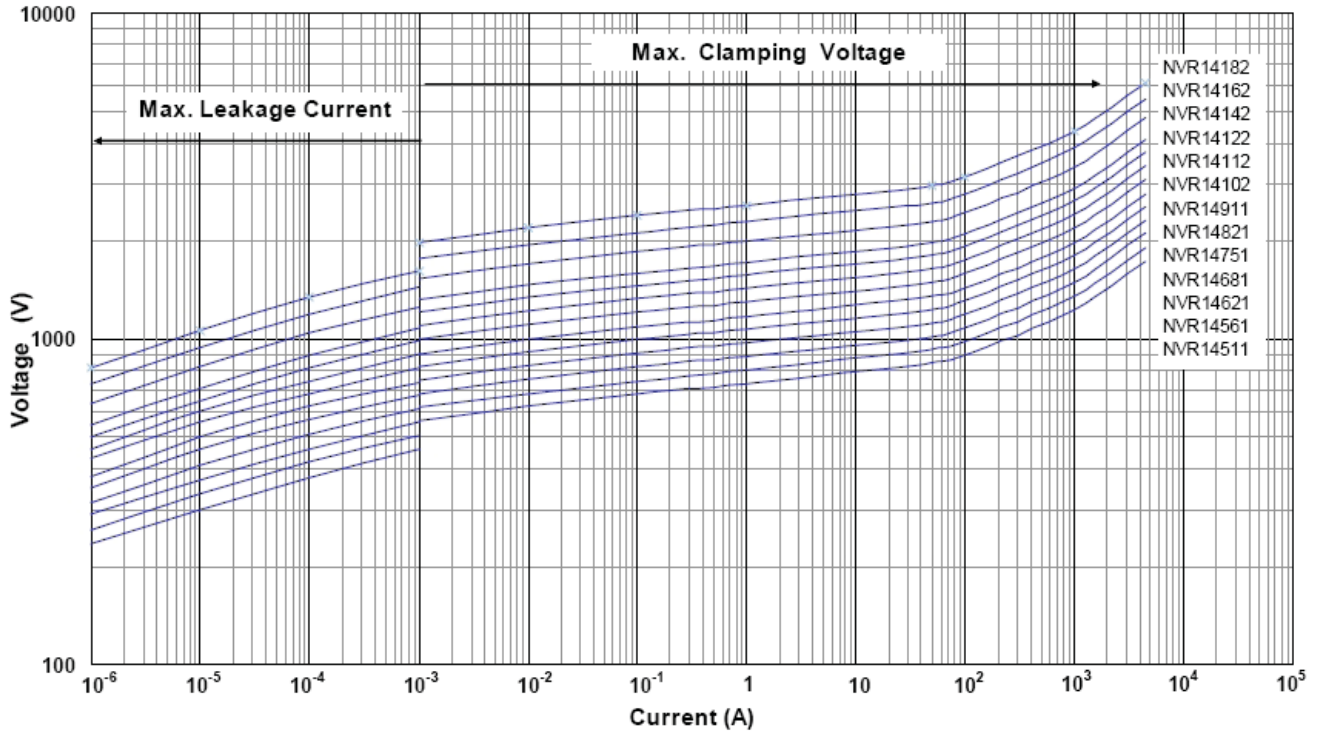

Max. Leakage Current and Max. Clamping Voltage Curves (NVR20 180 to 680)

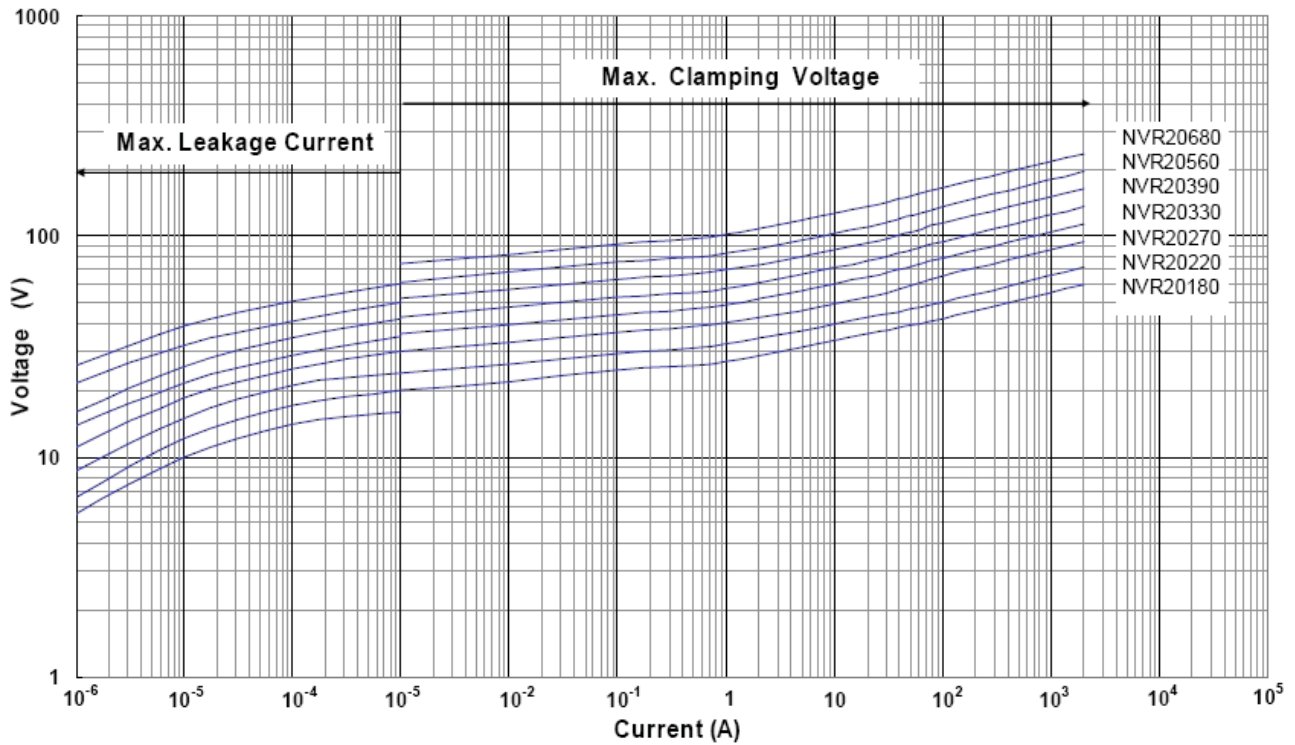

Max. Leakage Current and Max. Clamping Voltage Curves (NVR20 820 to 471)

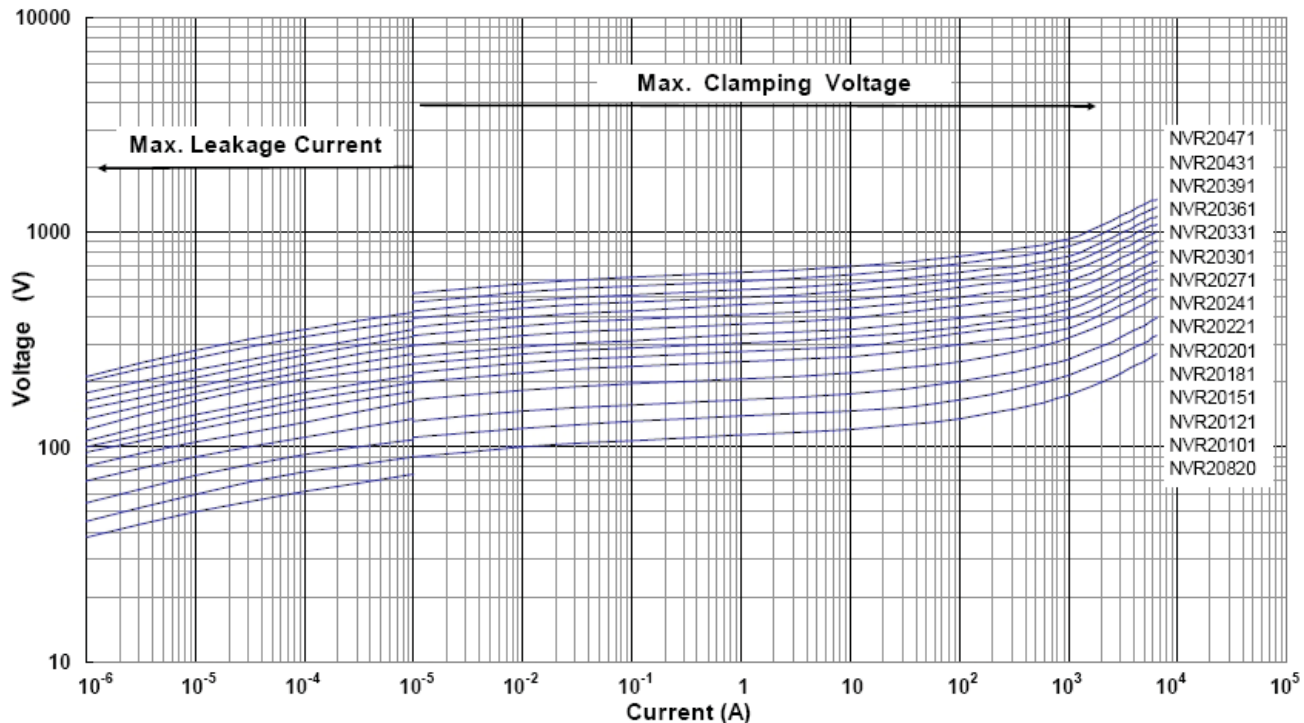

Max. Leakage Current and Max. Clamping Voltage Curves (NVR20 511 to 182)

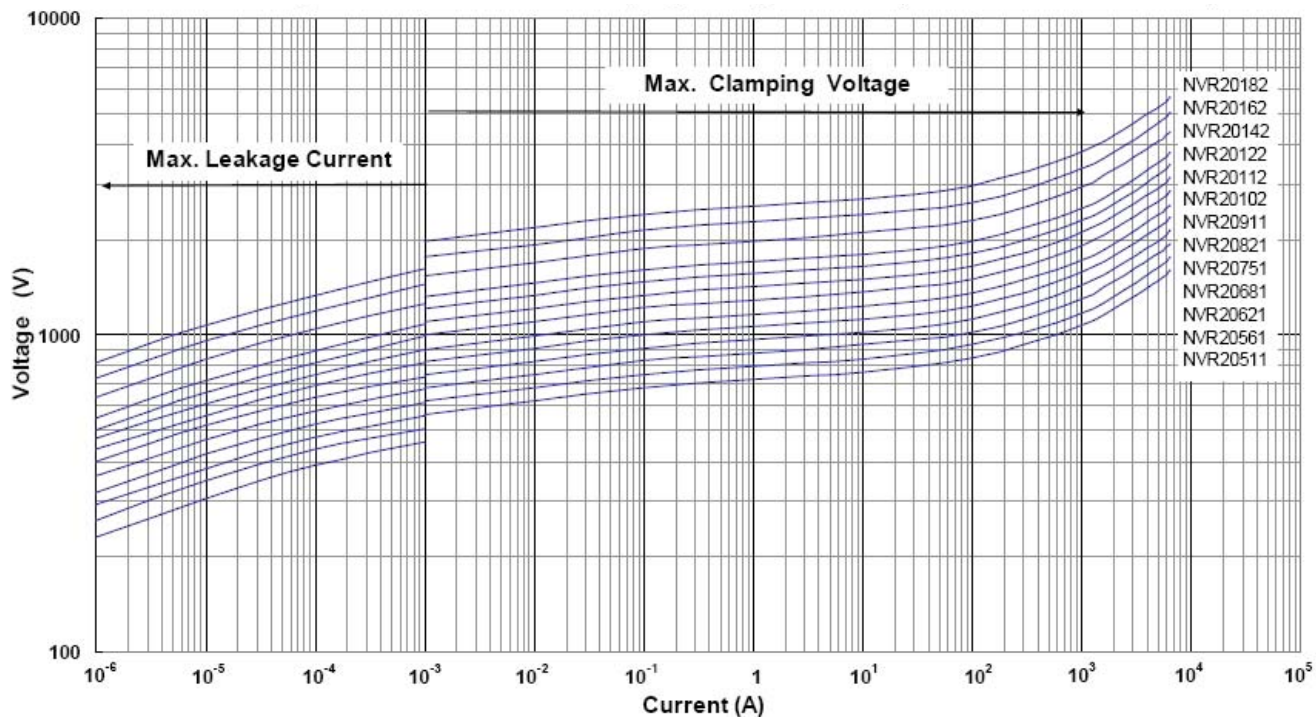

STRAIGHT LEADS

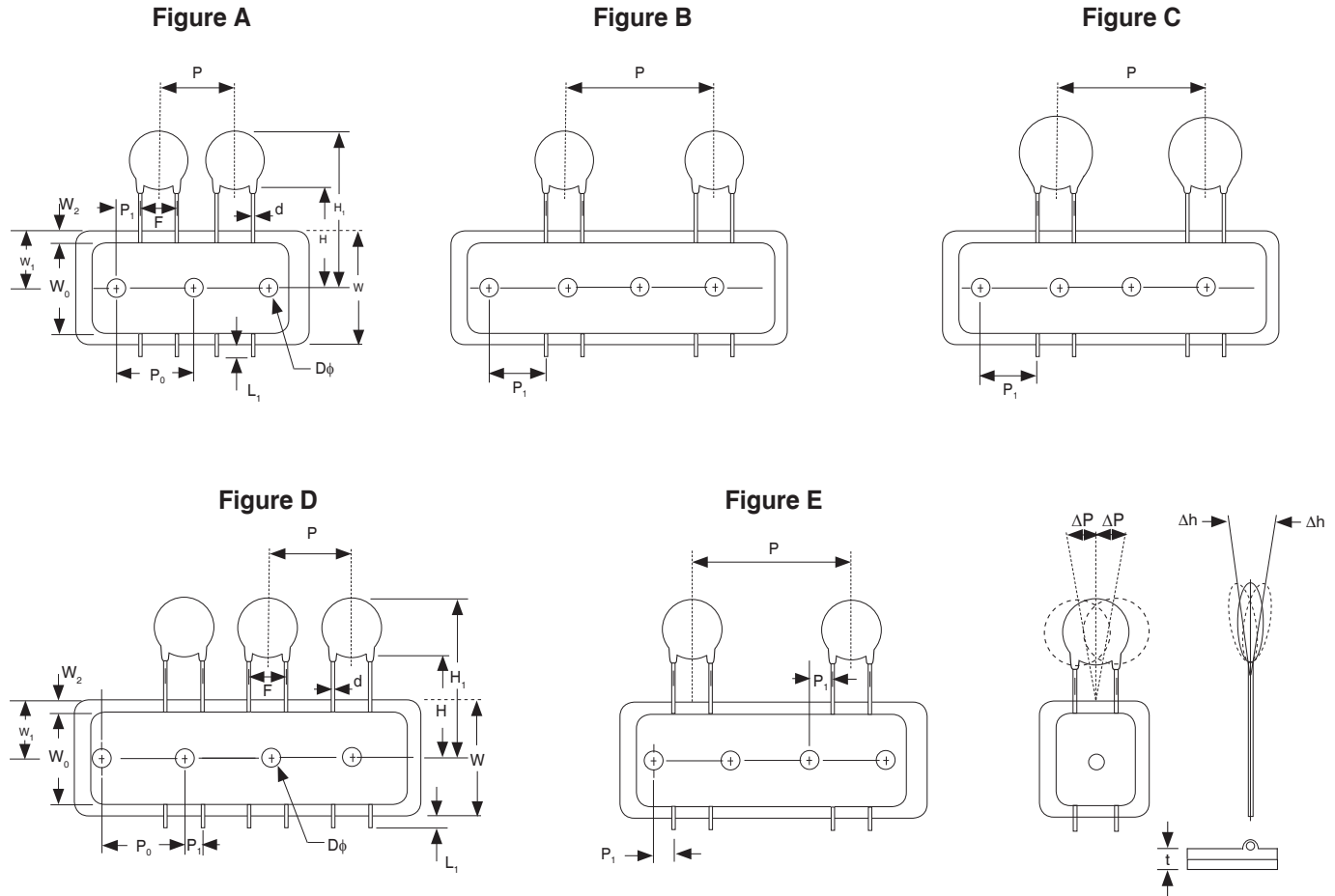

TAPING DIMENSIONS (mm)

Taping Code	Dia.	P_0 ± 0.3	F ± 1.0	P ± 1.0	P_1 ± 1.0	P_2 ± 1.3	H $+2/-0$	H_1 Max.	d ± 0.02	W_0 ± 1.0	W_1 $+0.75/-0.5$	W_2 Max.	W ± 1.0	ΔP Max.	Δh Max.	L_1 Max.	D_ϕ ± 0.2	t ± 0.2	Fig.
12.7mm Sprocket Hole Pitch	5	12.7	5.0	12.7	3.85	6.35	18	28.0	0.6	12	9	3	18	1	2	0.5	4	0.6	A
	7	12.7	5.0	12.7	3.85	6.35	18	30.0	0.6	12	9	3	18	1	2	0.5	4	0.6	A
	10	12.7	7.5	12.7	8.95	12.7	18	33.5	0.8	12	9	3	18	1	2	0.5	4	0.6	D
	14	12.7	7.5	25.4	8.95	12.7	18	38.0	0.8	12	9	3	18	1	2	0.5	4	0.6	B
	20	12.7	7.5	25.4	8.95	12.7	18	40.5	0.8	12	9	3	18	1	2	0.5	4	0.6	B
	20	12.7	10	38.1	7.70	12.7	18	40.5	1.0	12	9	3	18	1	2	0.5	4	0.6	C
15mm Sprocket Hole Pitch	5	15	5.0	15	5.0	7.5	18	28.0	0.6	12	9	3	18	1	2	0.5	4	0.6	A
	7	15	5.0	15	5.0	7.5	18	30.0	0.6	12	9	3	18	1	2	0.5	4	0.6	A
	10	15	7.5	15	3.75	7.5	18	33.5	0.8	12	9	3	18	1	2	0.5	4	0.6	A
	14	15	7.5	30	3.75	7.5	18	38.0	0.8	12	9	3	18	1	2	0.5	4	0.6	E
	20	15	7.5	30	3.75	7.5	18	40.5	0.8	12	9	3	18	1	2	0.5	4	0.6	E



CRIMPED LEADS

Figure A

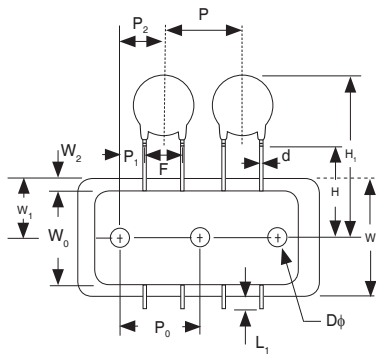

Figure B

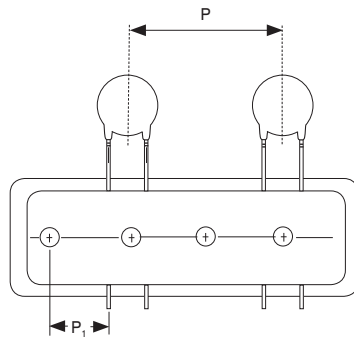

Figure C

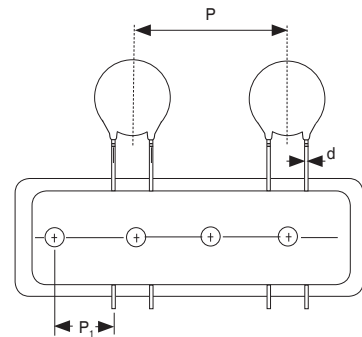

Figure D

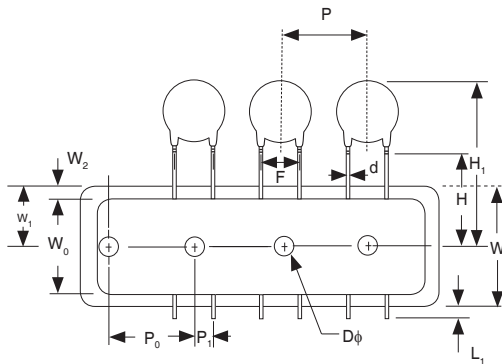
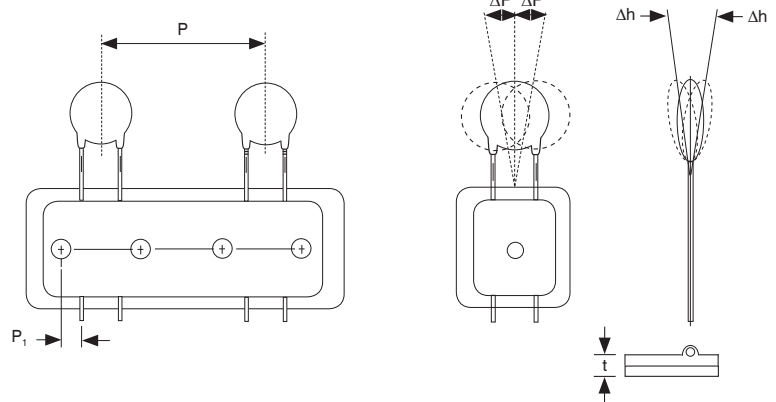

Figure E



Taping Code	Dia.	$P_0 \pm 0.3$	$F \pm 1.0$	$P \pm 1.0$	$P_1 \pm 1.0$	$P_2 \pm 1.3$	$H +2/-0$	$H_1 \text{ Max.}$	$d \pm 0.02$	$W_0 \pm 1.0$	$W_1 +0.75/-0.5$	$W_2 \text{ Max.}$	$W \pm 1.0$	$\Delta P \text{ Max.}$	$\Delta h \text{ Max.}$	$L_1 \text{ Max.}$	$D_\phi \pm 0.2$	$t \pm 0.2$	Fig.
12.7mm Sprocket Hole Pitch	5	12.7	5.0	12.7	3.85	6.35	16	28.0	0.6	12	9	3	18	1	2	0.5	4	0.6	A
	7	12.7	5.0	12.7	3.85	6.35	16	30.0	0.6	12	9	3	18	1	2	0.5	4	0.6	A
	10	12.7	7.5	12.7	8.95	12.7	16	33.5	0.8	12	9	3	18	1	2	0.5	4	0.6	D
	14	12.7	7.5	25.4	8.95	12.7	16	38.0	0.8	12	9	3	18	1	2	0.5	4	0.6	B
	20	12.7	7.5	25.4	8.95	12.7	16	40.5	0.8	12	9	3	18	1	2	0.5	4	0.6	B
	20	12.7	10	38.1	7.70	12.7	16	40.5	1.0	12	9	3	18	1	2	0.5	4	0.6	C
15mm Sprocket Hole Pitch	5	15	5.0	15.0	5.0	7.5	16	28.0	0.6	12	9	3	18	1	2	0.5	4	0.6	A
	7	15	5.0	15.0	5.0	7.5	16	30.0	0.6	12	9	3	18	1	2	0.5	4	0.6	A
	10	15	7.5	15.0	3.75	7.5	16	33.5	0.8	12	9	3	18	1	2	0.5	4	0.6	A
	14	15	7.5	30.0	3.75	7.5	16	38.0	0.8	12	9	3	18	1	2	0.5	4	0.6	E
	20	15	7.5	30.0	3.75	7.5	16	40.5	0.8	12	9	3	18	1	2	0.5	4	0.6	E



AMMO PACK

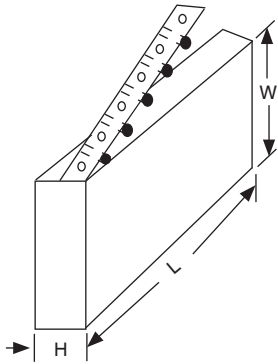

H = 60mm ± 5
 L = 185 or 275mm ± 5
 W = 348mm ± 5

TAPE & REEL

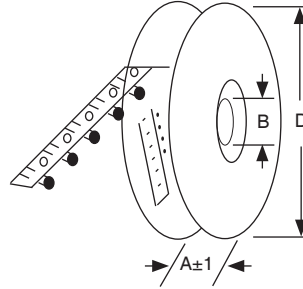

$\phi D = 340\text{mm} \pm 10$
 $\phi B = 31\text{mm} \pm 1.0$
 A = ($\phi 5-14$) 46, ($\phi 20$) 55

BULK PACKAGE QUANTITY (PER BAG)

Lead Type	5mm Dia.	7mm Dia.	10mm Dia.	14mm Dia.	20mm Dia.
Straight	250	250	200	100	50
Cut	250	250	200	100	50
Kinked	-	200	200	100	50

TAPE & REEL QUANTITY (PER REEL)

5mm Dia.		7mm Dia.		10mm Dia.		14mm Dia.		20mm Dia.	
Varistor Value	Quantity	Varistor Value	Quantity	Varistor Value	Quantity	Varistor Value	Quantity	Varistor Value	Quantity
180 ~ 391	1500	180 ~ 391	1500	180 ~ 911	1000	180 ~ 470	1000	180 ~ 681	500
431 ~ 751	1000	431 ~ 821	1000	102 ~ 112	750	560 ~ 391	750	751 ~ 182	250
-	-	-	-	122 ~ 182	500	431 ~ 182	500	-	-

TAPE & BOX QUANTITY (PER BOX)

5mm Dia.		7mm Dia.		10mm Dia.		14mm Dia.		20mm Dia.	
Varistor Value	Quantity	Varistor Value	Quantity	Varistor Value	Quantity	Varistor Value	Quantity	Varistor Value	Quantity
180 ~ 391	1000	180 ~ 821	1000	180 ~ 361	750	180 ~ 271	500	180 ~ 112	250
431 ~ 471	1200	-	-	391 ~ 621	500	301 ~ 112	250	122 ~ 182	200
511 ~ 751	1000	-	-	681 ~ 112	400	122 ~ 182	200	-	-
-	-	-	-	122 ~ 182	200	-	-	-	-