

TO-92 Plastic-Encapsulate MOSFETS

CJV01N60 N-Channel Power MOSFET

General Description

The high voltage MOSFET uses an advanced termination scheme to provide enhanced voltage-blocking capability without degrading performance over time. In addition, this advanced MOSFET is designed to withstand high energy in avalanche and commutation modes. The new energy efficient design also offers a drain-to-source diode with a fast recovery time. Designed for high voltage, high speed switching applications in power suppliers, converters and PWM motor controls, these devices are particularly well suited for bridge circuits where diode speed and commutating safe operating areas are critical and offer additional and safety margin against unexpected voltage transients.

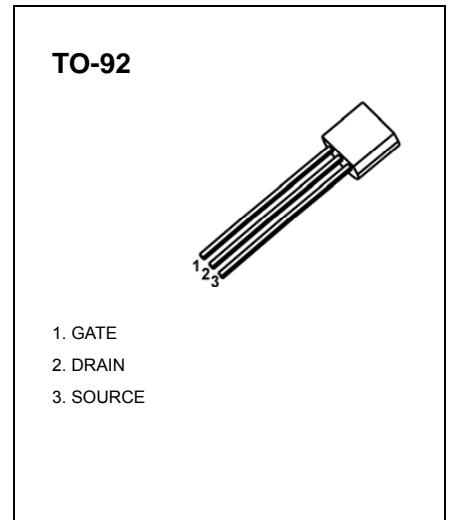

FEATURES

- Robust High Voltage Termination
- Avalanche Energy Specified
- Source-to-Drain Diode Recovery Time Comparable to a Discrete Fast Recovery Diode
- Diode is Characterized for Use in Bridge Circuits
- I_{DSS} and $V_{DS(on)}$ Specified at Elevated Temperature

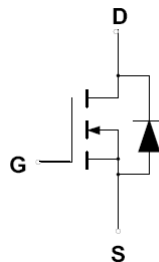

Maximum ratings ($T_a=25^\circ\text{C}$ unless otherwise noted)

Parameter	Symbol	Value	Unit
Drain-Source Voltage	V_{DS}	600	V
Gate-Source Voltage	V_{GS}	± 30	
Continuous Drain Current	I_D	1	A
Pulsed Drain Current	I_{DM}	9	
Power Dissipation	P_D	0.625	W
Single Pulsed Avalanche Energy*	E_{AS}	20	mJ
Thermal Resistance from Junction to Ambient	R_{thJA}	200	$^\circ\text{C}/\text{W}$
Junction Temperature	T_J	150	$^\circ\text{C}$
Storage Temperature	T_{stg}	-50 ~ +150	

* E_{AS} condition: $T_J=25^\circ\text{C}$, $V_{DD}=100\text{V}$, $V_{GS}=10\text{V}$, $L=10\text{mH}$, $I_{AS}=2\text{A}$, $R_G=25\Omega$

Electrical characteristics (T_a=25°C unless otherwise noted)

Parameter	Symbol	Test Condition	Min	Typ	Max	Units
Drain-Source Breakdown Voltage	V _{(BR)DSS}	V _{GS} = 0V, I _D =250μA	600			V
Gate-Threshold Voltage (note1)	V _{GS(th)}	V _{DS} =V _{GS} , I _D =250μA	2.0		4.0	
Gate-Body Leakage Current (note1)	I _{GSS}	V _{DS} =0V, V _{GS} =±20V			±100	nA
Zero Gate Voltage Drain Current	I _{DSS}	V _{DS} =600V, V _{GS} =0V			0.10	μA
Drain-Source On-State Resistance (note1)	R _{DS(on)}	V _{GS} =10V, I _D =0.6A			10	Ω
Forward Transconductance (note1)	g _{FS}	V _{DS} =50V, I _D =0.5A	0.5			S
Input Capacitance	C _{iss}	V _{DS} =25V, V _{GS} =0V, f =1MHz		210		pF
Output Capacitance	C _{oss}			28		
Reverse Transfer Capacitance	C _{rss}			4.2		
Turn-On Delay Time	t _{d(on)}	V _{DD} =300V, I _D =1A, V _{GS} =10V, R _G =18Ω		8		nS
Rise Time	t _r			21		
Turn-Off Delay Time	t _{d(off)}			18		
Fall Time	t _f			24		
Forward on Voltage(note1)	V _{SD}	V _{GS} =0V, I _S =1A			1.5	V

Notes:

1. Pulse Test : Pulse Width≤300μs, duty cycle ≤2%.

Output Characteristics

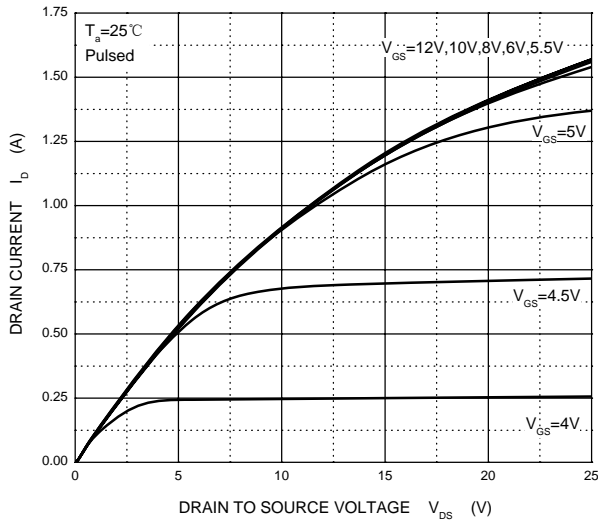

Transfer Characteristics

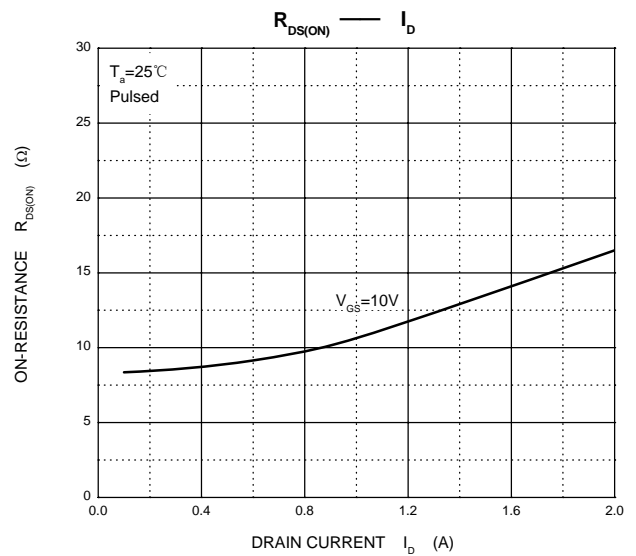
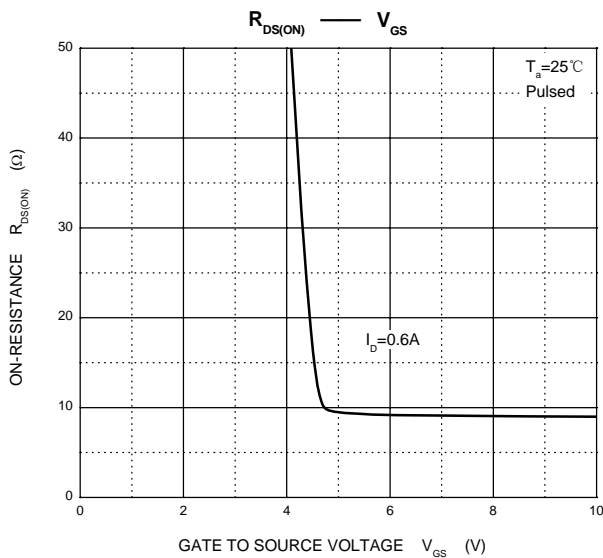
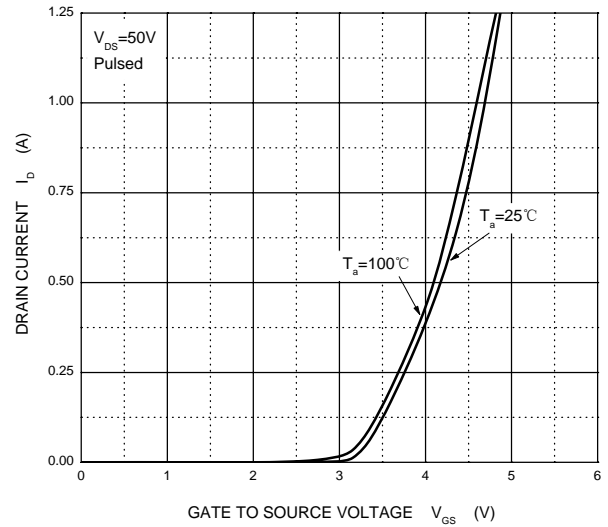

Threshold Voltage

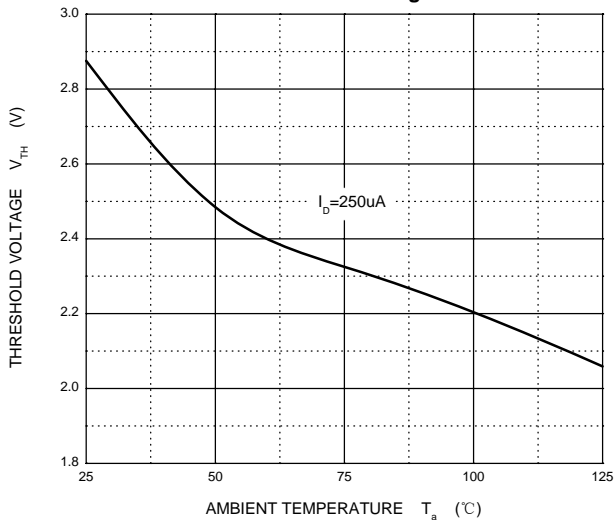

I_S — V_{SD}

