

GENERAL DESCRIPTION

The EM34006A is a single-chip LSI CMOS calculator with 12-digits 2-memory or 10-digits 2-memory. EM34006A can drive the liquid crystal display (LCD) with single power supply. Single power supply operation, wide operating voltage and lower power consumption make it suitable for 1.5V solar battery operated calculator. Beside EM34006A can have extraction_of_square_root, percentage, MU calculation and Auto Power OFF function.

FEATURES

- Display : 12-digit or 10-digit (selectable with a pin-programmable) of data, 1-digits of sign, error, memory load symbol.
- Algebraic mode.
- Standard 4 function (addition, subtraction, multiplication, division).
- Memory and Grand total calculation.
- Automatic percentage operation with add-on discount.
- Automatic delta percentage, mark-up and mark-down operations.
- Square root.
- Constant calculation.
- Chain calculation.
- Change sign.
- Floating point (selectable with a switch).
- Fixed point ("0", "2", "3", "4" selectable with a switch).
- Adding point mode(selectable with a switch).
- Rounding switch(rounding up, down and off).
- Trailing zero suppression.
- Punctuation on display, commas for thousands.
- Memory and GT memory contents indicator, turned with nonzero in the memory and GT memory.
- Registration overflow, indicating too many digits are entered (the most significant digit are protected).
- Result overflow, indicating during calculation (most function key are locked as it happened).
- Memory overflow indicating.
- Complementary output buffer for direct driving of liquid crystal display.
- Oscillator/clock generator internal to chip.
- Keyboard encoding internal to chip.
- Automatic power on clear.
- Wide supply voltage range (1.1 to 1.8V)
- Very low power consumption.
- Rough estimate calculation.

PIN DESCRIPTIONS

Symbol	I/O	Function
A12	O	Segment signal of LCD
B12	O	Segment signal of LCD
GND		Ground
VA		**
VB		**
V _{CC}		**
V _{DD}		+1.5V
TS1	I/O	Test pin
KI	I/O	ON key
K1	O	Key in 1
K2	O	Key in 2
K3	I/O	Key in 3
K4	I/O	Key in 4
K5	I/O	Key in 5
K6	I/O	Key in 6
K7	I/O	Key in 7
K8	I/O	Key in 8
K9	I	Key in 9
K10	I	Key in 10
K11	I	Key in 11
K12	I	Key in 12
K13		Key in 13
K14		Key in 14
COM1	O	Common signal 1
COM2	O	Common signal 2
COM3	O	Common signal 3
A0	O	Segment signal of LCD
B0	O	Segment signal of LCD
C0	O	Segment signal of LCD
B0	O	Segment signal of LCD
C0	O	Segment signal of LCD
A1	O	Segment signal of LCD
B1	O	Segment signal of LCD
C1	O	Segment signal of LCD
A2	O	Segment signal of LCD
B2	O	Segment signal of LCD
C2	O	Segment signal of LCD
A3	O	Segment signal of LCD
B3	O	Segment signal of LCD
C3	O	Segment signal of LCD
A4	O	Segment signal of LCD
B4	O	Segment signal of LCD

Symbol	I/O	Function
C4	O	Segment signal of LCD
A5	O	Segment signal of LCD
B5	O	Segment signal of LCD
C5	O	Segment signal of LCD
A6	O	Segment signal of LCD
B6	O	Segment signal of LCD
C6	O	Segment signal of LCD
A7	O	Segment signal of LCD
B7	O	Segment signal of LCD
C7	O	Segment signal of LCD
A8	O	Segment signal of LCD
B8	O	Segment signal of LCD
C8	O	Segment signal of LCD
A9	O	Segment signal of LCD
B9	O	Segment signal of LCD
C9	O	Segment signal of LCD
A10	O	Segment signal of LCD
B10	O	Segment signal of LCD
C10	O	Segment signal of LCD
A11	O	Segment signal of LCD
B11	O	Segment signal of LCD
C11	O	Segment signal of LCD

* Capacitor Terminal for Voltage Doubling

FUNCTION DESCRIPTIONS

A). Operation Characteristics

a). Constant Operation

The EM34006 has implied constant mode on +, -, X, ÷, % operations. The constant is performed automatically by the "=" key, "%" key, or "%%" key without a constant for addition, subtraction and division while the first operand is the constant for multiplication.

b). Number Entry

Numericals can be entered up to 12-digit (10-digit).

c). Memory Protection

In any error detection, the memory contents before the error detection are protected.

d). Memory Indication

If the memory contents are a number other than zero, "M" is indicated in the sign-digit position.

e). Auto Power Off

If no key is depressed for a specific period of time, the power supply will automatically turn off (pin option). This time interval up to power-off is 4 mins.

f). Key Definition

i). Touch Key Constitution

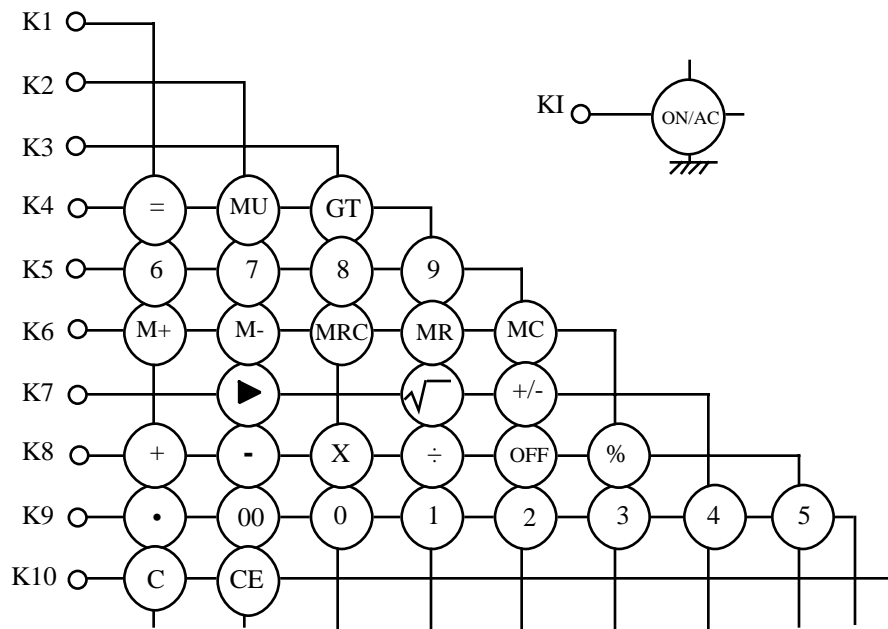

ii). Switches

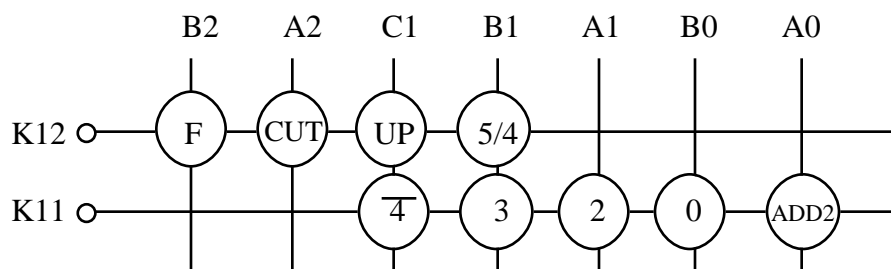

K11: Selectable with fixed point.
K12 : Rounding switches for mode select.
F : Floating
CUT, UP, 5/4 : Round select.

B). Keyboard Description

- a). Equal Key (=)
 - i). Performs Keyed-in operation and maintains that operation for possible use.
 - ii). Establishes power/reciprocation calculation.

- b). Multiplication Key (X)
 - i). Enters multiplicand.
 - ii). Performs previous operation and displays result.

- c). Division Key (\div)
 - i). Enters dividend.
 - ii). Performs previous operation and displays result.

- d). Addition Key (+)
 - i). Conditions machine for an addition.
 - ii). Performs previous operation and displays result.

- e). Subtraction Key (-)
 - i). Conditions machine for a subtraction.
 - ii). Performs previous operation and displays result.

- f). Percent Key (%)

The purpose of the percent key is to allow for calculation of add-on and discount. Determination of add-on requires the principal amount to be the first entry followed by the "+" or "X" key, with the percentage being the second entry. Depression of the percent key yields the amount to add on, such as tax or interest. Depression of the "=" key adds this amount to the principal.

- g). Change Sign Key (+/-)

Pushing the "+/-" key twice in succession causes the corresponding sign to appear and disappear. During digit entry, this function changes the sign of the entered factor.

- h). Power On/All Clear Key (ON/AC)
 - i). A push will power on the calculation or clear all operation register.

- i). Clear Key (C)
 - i). During the digit entry, the first depression will clear all except memory contents.

- j). Clear Entry Key (CE)

During the digit entry will clear the entry register and display number "0".

- k). Square Root Key ($\sqrt{\quad}$)

Extracts the square root of a positive number displayed in the entry register.

- l). Memory Plus Key (M+)
 - i). Adds the current display to the contents of memory.
 - ii). It will terminate a number entry.

- m). Memory Minus Key (M-)
- Subtracts the current display from the contents of memory
 - It will terminate a number entry.
- n). Memory Recall and Clear Key (RCM)
- First push, as RM key, transfers the contents of the memory register into the display register.
 - Second push, as CM key, clears the memory.
- o). Number, Decimal Key ("00", "0 - 9", ".")
- The first number key in a sequence will clear the display and enter the digit in the display. Successive entries will shift the display left and enters the data in display register. The first decimal point entered is effective. An attempted entry of more than 13 digits or 11 decimal places will be ignored.
- p). Ground Total Memory Key (GT)
- Push GT key, transfers the contents of the GT memory register.
 - GT flag is released by AC or C key.
- q). Shift Key (→)
- Delete the rightest digit and others will shift to right.
- r). Off key (OFF)
- Turn off the power.
- C). Selection Mode Switch Functions
- 10-digit/12-digit mode depends on K11 pin, please refer to application circuit.
Fixed/floating decimal point mode and ADD2 mode are selected by rounding switch.
The rounding switch should be so composed that either one of 4, 3, 2, 0, ADD2 is selected.
- Fix "F" mode
When TAB "F" is selected, both entered numbers and calculation results follow to floating decimal point system.
 - DP $i=0, 2, 3, 4$ mode
The calculation results follow to fixed decimal point system and $i + 1$ decimal place is counted by "CUT", "UP", "5/4".
 - Fix "CUT" mode
The number of $i + 1$ decimal position is counted as cutting away.
 - Fix "UP" mode
The number of i decimal position is counted as added to "1",
 - Fix "5/4" mode
When a number of $i + 1$ decimal position is more than 0.5, the number of i decimal position is counted as added to "1".
 - Add2 mode
When "+" and "-" operation are performed after a number except decimal point is entered. The calculation is executed as 1/100 value of number being entered.
- C). Key Bounce Protection
- Front edge
Minnum=50 words
 - Trailing edge

Minnum=66 words

1 word=88.75 μ s when operating frequency Fd=469 Hz

E). Basic function

Fixed point mode calculations

Switch mode		key	Display	Key	Display
Fix	DP SW				
5/4	0	Ac	2	Ac	0
	2	5÷3	1.67	1÷3	0.33
	3	=	1.667	=	0.333
	4		1.6667		0.3333
CUT	0	Ac	1	Ac	0
	2	5÷3	1.66	1÷3	0.33
	3	=	1.666	=	0.333
	4		1.6666		0.3333
UP	0	Ac	2	Ac	1
	2	5÷3	1.67	1÷3	0.34
	3	=	1.667	=	0.334
	4		1.6667		0.3334

Floating point mode calculations

Switch mode		key	Display	
Fix	DP SW			
F	Don't Care	Ac	GT 1.6666666666	12 digit
		5÷3	GT 1.6666666666	10 digit
		=		
		AC	GT 0.3333333333	12 digit
		1÷3	GT 0.3333333333	10 digit
		=		

Adding point mode calculations

Switch mode		key	Display	Key	Display
Fix	DP SW				
Don't Care Except Fix "F"	ADD2	AC	0	678	678
		531	531	M+	-2.91
		+	5.31	235	235
		23	23	+	2.35
		=	5.54	987	987
		387	387	M-	12.22
		-	3.87	MR	-15.13

Constant calculations

Multiplication

Key	Display	Constant
k	k	
X	k	
X	k	
a	a	
=	$k \cdot a$	kX
b	b	kX
=	$k \cdot b$	kX

Division

Key	Display	Constant
k	k	
÷	k	
÷	k	
a	a	
=	a/k	÷k
b	b	÷k
=	b/k	÷k

Addition

Key	Display	Constant
k	k	
+	k	
+	k	
a	a	
=	$a+k$	+k
b	b	+k
=	$b+k$	+k

Subtraction

Key	Display	Constant
k	k	
-	k	
-	k	
a	a	
=	$a-k$	-k
b	b	-k
=	$b-k$	-k

Percentage

Key	Display	Constant
k	k	
X	k	
X	k	
a	a	
%	$k \cdot a/100$	kx
b	b	kx
%	$k \cdot b/100$	kx

Percentage

Key	Display	Constant
k	k	
÷	k	
÷	k	
a	a	
%	$100 \cdot a/k$	÷k
b	b	÷k
%	$100 \cdot b/k$	÷k

Add-on, discount calculations

Add-on

Key	Display
a	a
X	a
b	b
%	$a \cdot b/100$
+	$a(1+b/100)$

Discount

Key	Display
a	a
X	a
b	b
%	$a \cdot b/100$
-	$a(1-b/100)$

F). Additional calculations

Power calculations

$(4.2^3)^2 = 4.2^6$

FIX=F

4.2 $\boxed{\times} \boxed{\times} \boxed{=} \boxed{=} \boxed{\times} \boxed{=}$ GT 5 489.031744

Inverse number calculation

$1/7 = 0.142857 \dots$

FIX=F

7 $\boxed{\div} \boxed{\div} \boxed{=} \boxed{=}$ GT 0.14285714285

Root calculation

$5\sqrt{\quad} = 2.2360679 \dots$

FIX=F

5 $\boxed{\sqrt{\quad}}$ GT 2.23606797749

Memory calculation

$$\begin{array}{r} 35 \times 6 = 210 \\ -) 76 \div 8 = 9.5 \\ +) 25 + 17 = 42 \\ \hline 242.5 \end{array}$$

FIX=F
 \boxed{MC} 35 $\boxed{\times}$ 6 M+ M210
 76 $\boxed{\div}$ 8 M- M 9.5
 25 $\boxed{+}$ 17 M+ M42
 \boxed{RM} M 242.5

GT memory calculation

$(35 \times 6) + (76 \div 8) + (25 + 17) = 267.5$

FIX=F

AC 36 $\boxed{\times}$ 6 = GT 216.
 76 $\boxed{\div}$ 8 = GT 9.5
 25 $\boxed{+}$ 17 = GT 42.0
 \boxed{GT} GT 267.5

FIX=F

key
 9999999999 $\boxed{=}$
 5 $\boxed{+}$
 3 $\boxed{=}$

key display
 GT 9999999999.
 GT 5.
 GT E 0. System error

Mark-up, Mark-down calculation

Addition

Key	Display
a	a
+	a
b	b
MU	100 ((a+b)/b)
MU	a+b

Subtraction

Key	Display
a	a
-	a
b	b
MU	100 ((a+b)/b)
MU	a-b

Multiplication

Key	Display
a	a
x	a
b	b
MU	$a(1+b/100)$
MU	$ ab/100 $

Key	Display
a	a
x	a
b	b
+/-	-b
MU	$a(1-b/100)$
MU	$ ab/100 $

Division

Key	Display
a	a
÷	a
b	b
MU	$a(1-b/100)$
MU	$ a/(1-b/100)-a $

Key	Display
a	a
-	a
b	b
+/-	$a/(1+b/100)$
MU	$ a/(1+b/100)-a $

G). Error Conditions

a). Error Detections (Parenthesis is in case of 10 digit)

System errors occur when :

- i) The division by zero.
- ii) The integral part of any memory calculation results exceeds 12 (10) digits.
- iii) The integral part of GT memory contents exceeds 12 (10) digits.

Rough estimate calculation error

The integral part of any calculation-four standard function, %, square, or power calculation result exceeds 12 digits (10 digits).

b). Error Indication

i) System error:

- a) Zero is displayed at first-digit and "E" sign is indicated at symbol.

ii) Rough estimate calculation error

The high-order 12-digit (10 digits) of any calculation result is indicated with "E" sign and the decimal point is displayed at the position corresponding to 10^{-12} (10^{-10}) of the calculation result also no zero shift is performed.

c). Error Release

System error:

Released by AC, C, CE key.

H). LCD Display

a). Inter Connection of LCD

i). Select of 10-digits

1) Segment

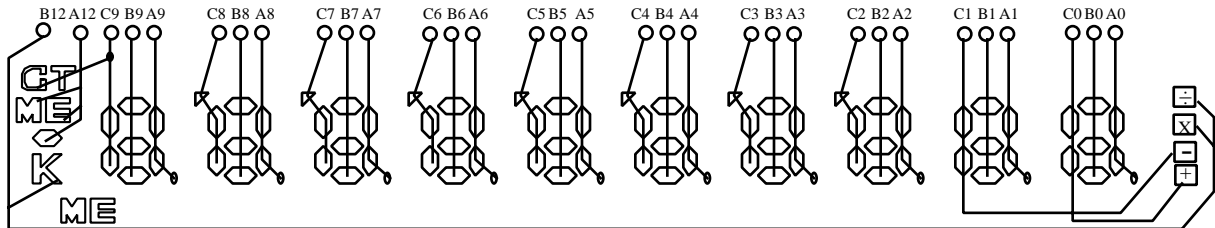

2) Common

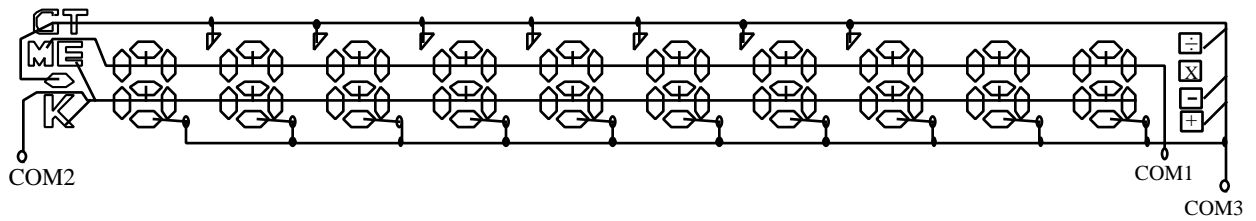

ii). Select of 12-digits

1) Segment

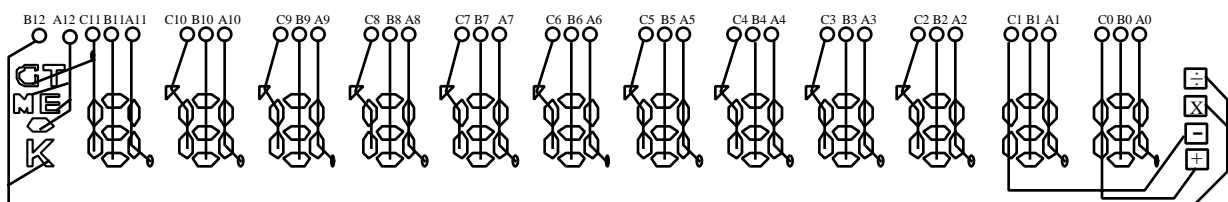

2) Common

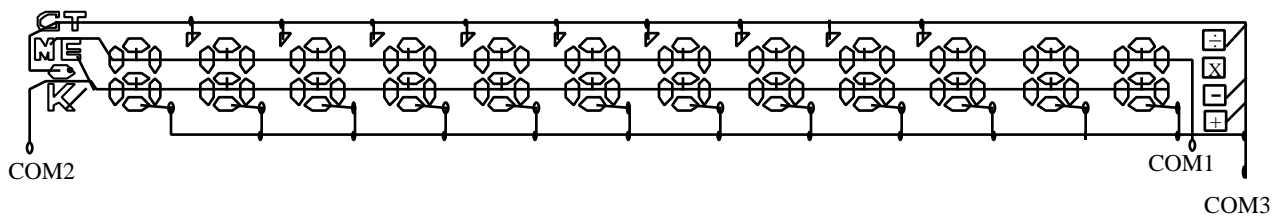

E). Waveforms for Display

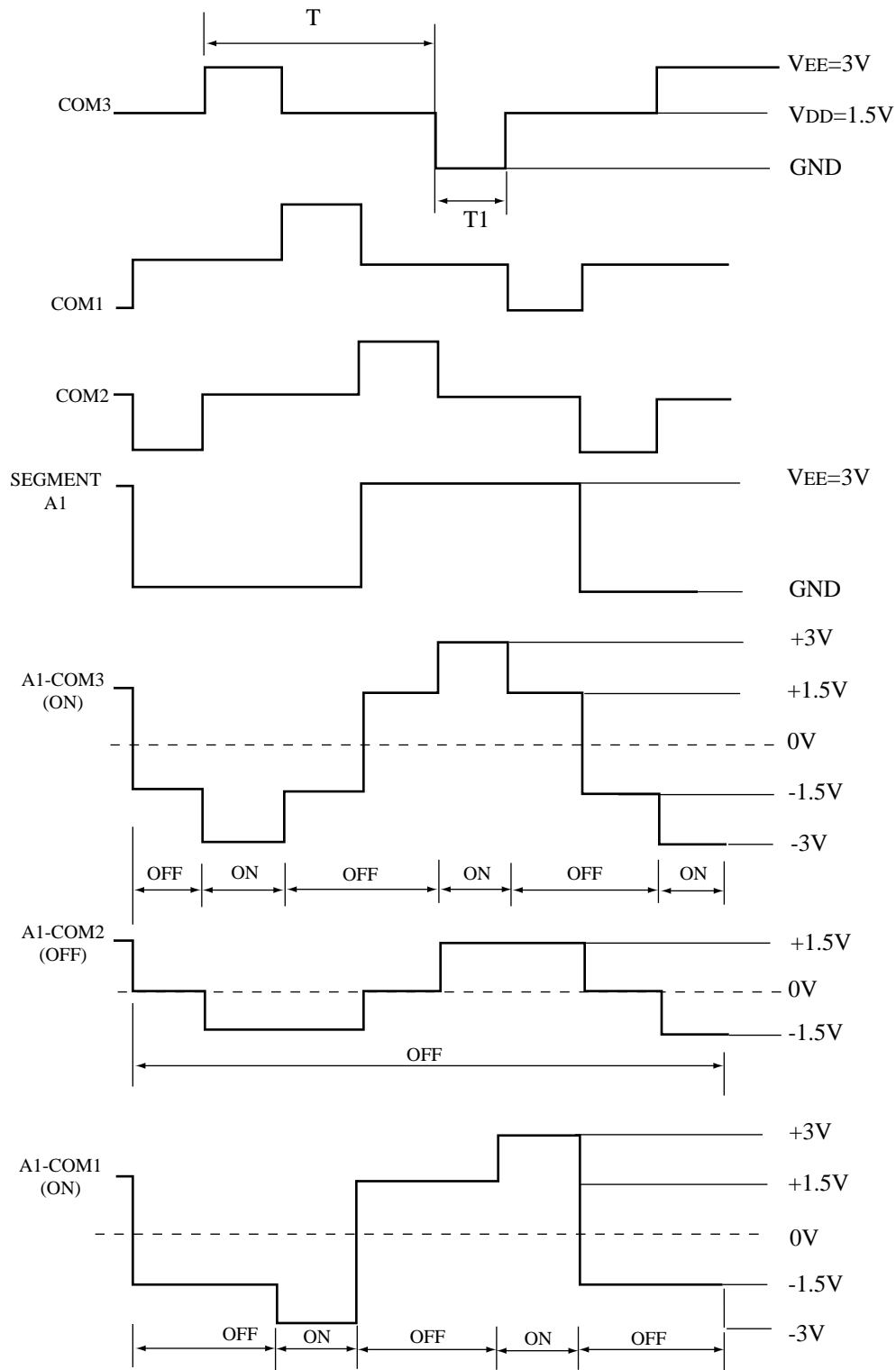

When $f_0=18\text{ KHz}$

$T=1/93.8\text{ Hz}$ $T_1=3.56\text{ ms}$

ABSOLUTE MAXIMUM RATINGS

Items	Sym.	Min.	Max.	Unit
Supply Voltage	$V_{DD} - V_{SS}$	-0.3	2.0	V
Input Voltage	V_{in}	-0.3	$V_{DD} + 0.3$	V
Operating Temperature	Top	0	50	°C
Storage Temperature	Tstg	-55	+125	°C

ELECTRICAL CHARACTERISTICS

($V_{DD} = 1.5V \pm 0.2V$, $GND = 0V$, $T_A = 25^\circ C$, $V_{EE} = 3.0 \pm 0.4V$)

Parameter	Name	Sym.	Min.	Typ.	Max.	Unit	Condition
Operating Voltage	-	V_{DD}	1.1	1.5	1.8	V	
"1" Input Voltage	K3~K10 RESET	$V_{IH}(1)$	$V_{DD} - 0.4$	-	V_{DD}	V	
"1" Input Voltage	K11~K14	$V_{IH}(2)$	$V_{EE} - 0.4$	-	V_{EE}	V	
"0" Input Voltage	K3~K14 RESET	V_{IL}	0	-	0.4	V	
"1" Output Voltage	SEGMENT COM1~3	$V_{OH}(1)$	$V_{EE} - 0.2$	-	V_{EE}	V	
"0" Output Voltage	SEGMENT COM1~3	$V_{OL}(1)$	0	-	0.2	V	
"M" Output Voltage	COM1~3	V_{OM}	$V_{DD} - 0.2$	-	$V_{DD} + 0.2$	V	
"1" Output Voltage	K1~K10	$V_{OH}(2)$	$V_{DD} - 0.2$	-	V_{DD}	V	
"0" Output Voltage	K1~K14	$V_{OL}(2)$	0	-	0.2	V	
"1" Output Resistance	SEGMENT COM1~3	R_{OH}	-	-	70	K Ω	$V_{OUT} = V_{EE} - 0.5V$
"0" Output Resistance	SEGMENT COM1~3	R_{OL}	-	-	70	K Ω	$V_{OUT} = 0.5V$
Key Pull Down Resistance	K1~K10	$R_{KEYL}(1)$	240	-	650	K Ω	$V_{OUT} = V_{DD}$
Key Pull Up Resistance	K1~K10 RESET	$R_{KEYH}(1)$ $R_{KEYH}(2)$	- 50	- -	10 370	K Ω K Ω	$V_{OUT} = 0.5V$ $V_{OUT} = 0.5V$
Oscillating (WAIT)		f_{0_WAIT}	10.8	18.0	25.2	KHz	$V_{DD} = 1.5V$
Frequency (OPERATE)		f_{0_OP}	57.6	96.0	134.4	KHz	$V_{DD} = 1.5V$
Frame Frequency	SEGMENT COM1~3	f_F	56.3	93.8	131	Hz	$V_{DD} = 1.5V$
Supply Current	1(WAIT) 2(OPERATE) 3(OFF)	I_{DD_WAIT} I_{DD_OP} I_{DD_OFF}	- - -	2.2 7.0 -	3.4 11.0 1.0	μA μA μA	$V_{DD} = 1.5V$ $V_{DD} = 1.5V$ $V_{DD} = 1.5V$

APPLICATION CIRCUIT

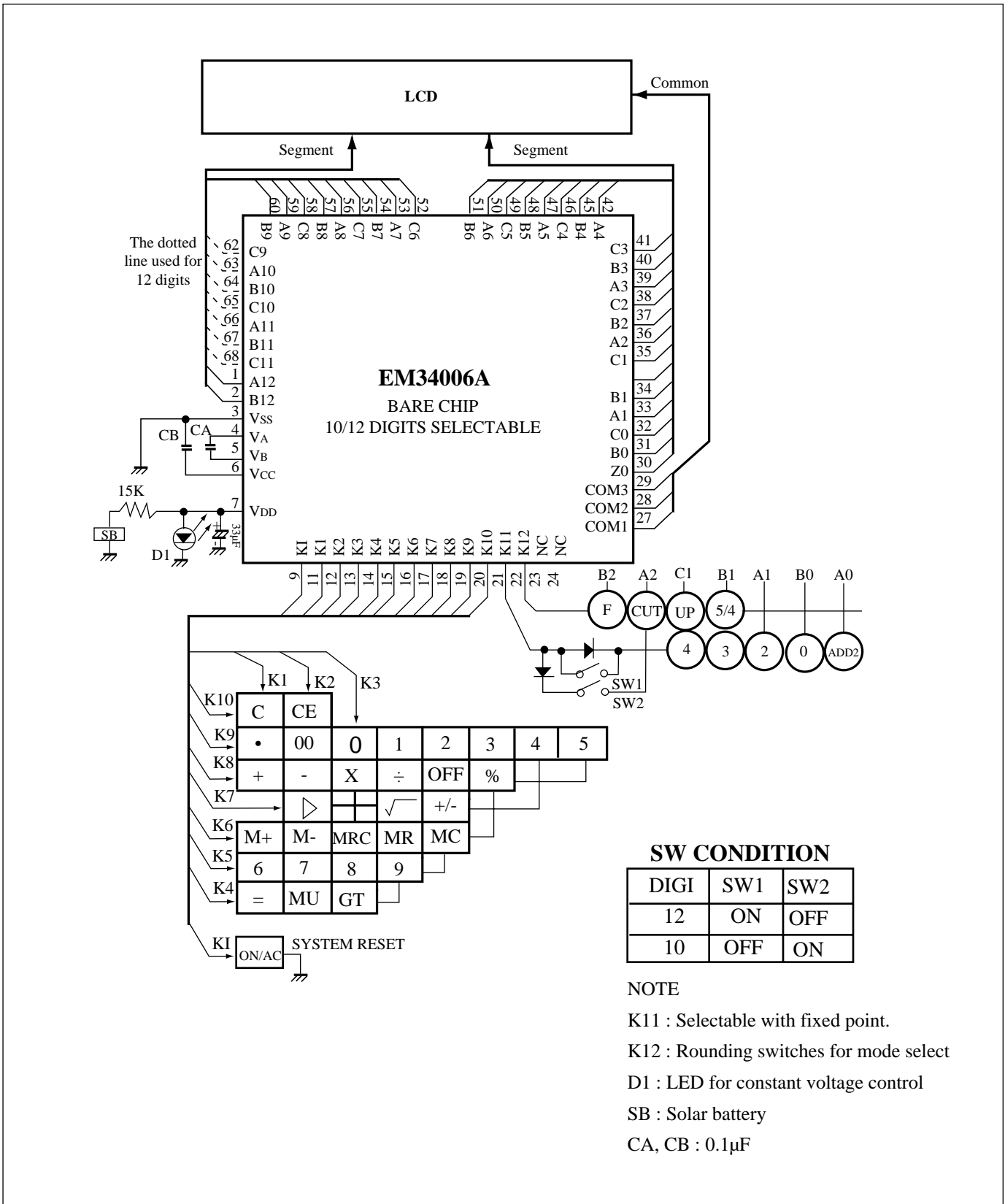

PAD DIAGRAM

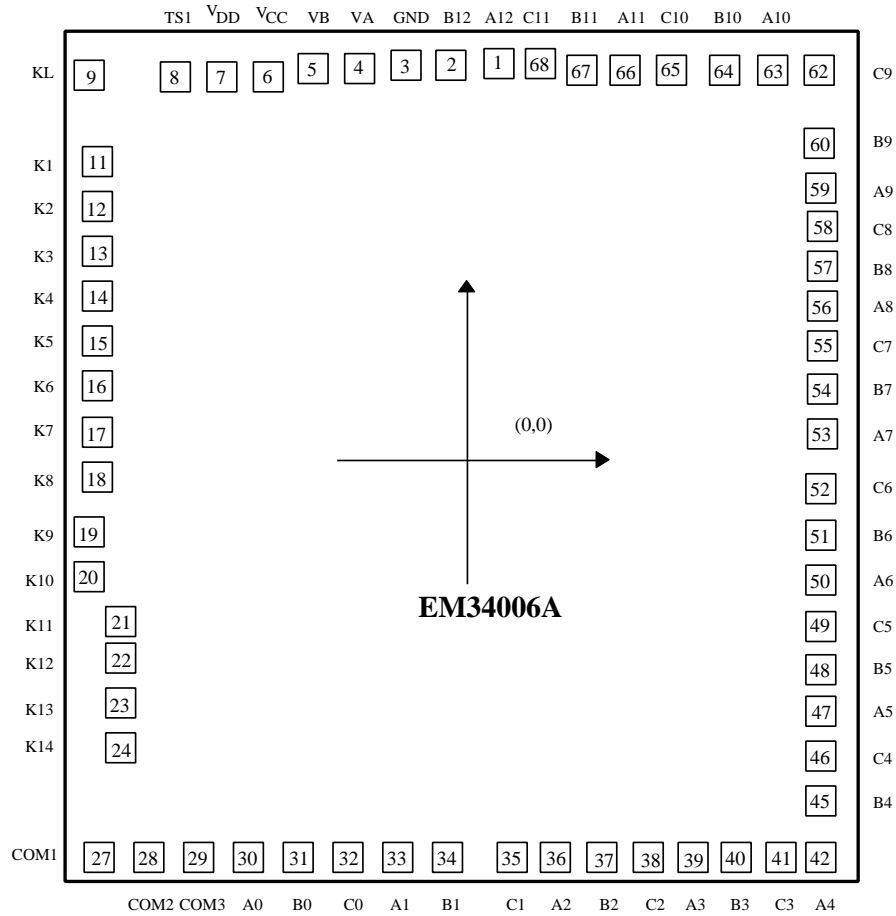

Chip Size : 2520x 2930 μm

Pad No.	Symbol	X	Y
1	A12	83.8	1297.6
2	B12	-60.2	1297.6
3	GND	-204.2	1297.6
4	VA	-348.2	1279.1
5	VB	-492.2	1279.1
6	VCC	-636.2	1262.1
7	VDD	-806.3	1261.4
8	TS1	-953.9	1262.8
9	KL	-1097.9	1272.6
10			
11	K1	-1063.1	1009.4
12	K2	-1063.1	860.0
13	K3	-1063.1	709.3
14	K4	-1063.1	559.9
15	K5	-1063.1	409.2
16	K6	-1063.1	259.8
17	K7	-1063.1	109.2



Pad No.	Symbol	X	Y
18	K8	-1063.1	-40.2
19	K9	-1092.7	-187.6
20	K10	-1092.7	-337.0
21	K11	-1045.3	-482.8
22	K12	-1045.3	-638.3
23	K13	-1045.3	-782.3
24	K14	-1045.3	-937.8
25			
26			
27	COM1	-1097.9	-1309.9
28	COM2	-953.9	-1309.9
29	COM3	-809.9	-1309.9
30	A0	-634.6	-1309.9
31	B0	-490.6	-1309.9
32	C0	-346.6	-1309.9
33	A1	-202.6	-1309.9
34	B1	-58.6	-1309.9
35	C1	85.4	-1309.9
36	A2	229.4	-1309.9
37	B2	373.4	-1309.9
38	C2	517.4	-1309.9
39	A3	661.4	-1309.9
40	B3	805.4	-1309.9
41	C3	949.4	-1309.9
42	A4	1093.4	-1309.9
43			
44			
45	B4	1099.9	-1104.7
46	C4	1099.9	-960.7
47	A5	1099.9	-816.7
48	B5	1099.9	-672.7
49	C5	1099.9	-528.7
50	A6	1099.9	-384.7
51	B6	1099.9	-240.7
52	C6	1099.9	-96.7
53	A7	1099.9	47.3
54	B7	1099.9	191.3
55	C7	1099.9	335.3
56	A8	1099.9	479.3
57	B8	1099.9	623.3
58	C8	1099.9	767.3
59	A9	1099.9	911.3
60	B9	1099.9	1055.2



Pad No.	Symbol	X	Y
61			
62	C9	1091.8	1297.6
63	A10	947.8	1297.6
64	B10	803.8	1297.6
65	C10	659.8	1297.6
66	A11	515.8	1297.6
67	B11	371.8	1297.6
68	C11	227.8	1297.6