

FEATURES

3-axis sensing

Small, low profile package

3 mm × 3 mm × 1.45 mm LFCSP

Low power: 300 μ A (typical)

Single-supply operation: 1.8 V to 3.6 V

10,000 g shock survival

Excellent temperature stability

Bandwidth adjustment with a single capacitor per axis

RoHS/WEEE and lead-free compliant

APPLICATIONS

Concussion and head trauma detection

High force event detection

GENERAL DESCRIPTION

The [ADXL377](#) is a small, thin, low power, complete 3-axis accelerometer with signal conditioned voltage outputs. The [ADXL377](#) measures acceleration resulting from motion, shock, or vibration with a typical full-scale range of ± 200 g.

The user selects the bandwidth of the accelerometer using the C_X , C_Y , and C_Z capacitors at the X_{OUT} , Y_{OUT} , and Z_{OUT} pins. Bandwidths can be selected to suit the application, with a range of 0.5 Hz to 1300 Hz for the x-axis and y-axis and a range of 0.5 Hz to 1000 Hz for the z-axis.

The [ADXL377](#) is available in a small, low profile, 3 mm × 3 mm × 1.45 mm, 16-lead lead frame chip scale package (LFCSP_LQ).

FUNCTIONAL BLOCK DIAGRAM

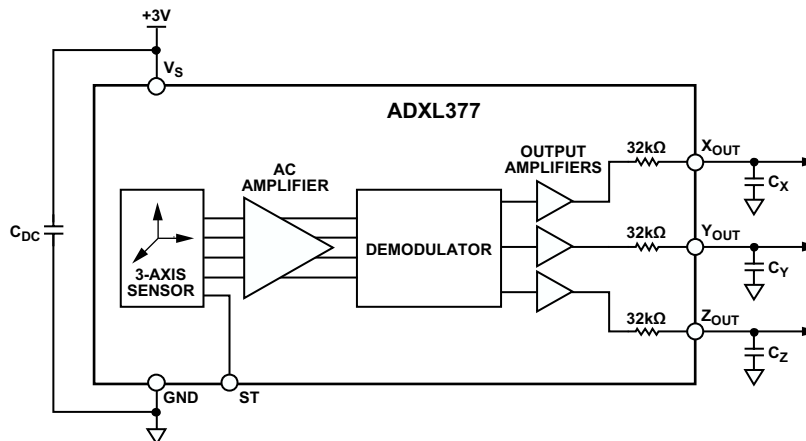

Figure 1.

10765-001

Rev. 0

[Document Feedback](#)

Information furnished by Analog Devices is believed to be accurate and reliable. However, no responsibility is assumed by Analog Devices for its use, nor for any infringements of patents or other rights of third parties that may result from its use. Specifications subject to change without notice. No license is granted by implication or otherwise under any patent or patent rights of Analog Devices. Trademarks and registered trademarks are the property of their respective owners.

One Technology Way, P.O. Box 9106, Norwood, MA 02062-9106, U.S.A.
Tel: 781.329.4700 ©2012 Analog Devices, Inc. All rights reserved.
[Technical Support](#) www.analog.com

TABLE OF CONTENTS

Features	1	Performance	8
Applications	1	Applications Information	9
General Description	1	Power Supply Decoupling	9
Functional Block Diagram	1	Setting the Bandwidth Using C_x , C_y , and C_z	9
Revision History	2	Self-Test	9
Specifications.....	3	Selecting Filter Characteristics: Noise/Bandwidth Trade-Off....	9
Absolute Maximum Ratings.....	4	Axes of Acceleration Sensitivity	10
ESD Caution.....	4	Layout and Design Recommendations	11
Pin Configuration and Function Descriptions.....	5	Outline Dimensions	12
Typical Performance Characteristics	6	Ordering Guide	12
Theory of Operation	8		
Mechanical Sensor.....	8		

REVISION HISTORY

9/12—Revision 0: Initial Version

SPECIFICATIONS

$T_A = 25^\circ\text{C}$, $V_S = 3\text{ V}$, $C_X = C_Y = C_Z = 0.1\ \mu\text{F}$, acceleration = 0 g, unless otherwise noted. All minimum and maximum specifications are guaranteed. Typical specifications are not guaranteed.

Table 1.

Parameter	Test Conditions/Comments	Min	Typ	Max	Unit
SENSOR INPUT	Each axis				
Measurement Range			±200		g
Nonlinearity	% of full scale up to 180 g		±0.5		%
Cross-Axis Sensitivity ¹			±1.4		%
SENSITIVITY, RATIOMETRIC ²	Each axis				
Sensitivity at X_{OUT} , Y_{OUT} , and Z_{OUT}	$V_S = 3\text{ V}$	5.8	6.5	7.2	mV/g
Sensitivity Change Due to Temperature ³	$V_S = 3\text{ V}$		±0.02		%/°C
ZERO g BIAS LEVEL, RATIOMETRIC					
Zero g Voltage	$V_S = 3\text{ V}$, $T_A = 25^\circ\text{C}$	1.4	1.5	1.6	V
Zero g Offset vs. Temperature					
X-Axis and Y-Axis			±12		mg/°C
Z-Axis			±30		mg/°C
NOISE PERFORMANCE					
Noise Density					
X_{OUT} and Y_{OUT}			2.7		mg/√Hz
Z_{OUT}			4.3		mg/√Hz
FREQUENCY RESPONSE ⁴					
Bandwidth ⁵	No external filter				
X_{OUT} and Y_{OUT}			1300		Hz
Z_{OUT}			1000		Hz
R_{FILT} Tolerance			32 ± 15%		kΩ
Sensor Resonant Frequency			16.5		kHz
SELF-TEST ⁶					
Logic Input Low			0.6		V
Logic Input High			2.4		V
ST Actuation Current			60		μA
Output Change	Self-test, 0 to 1				
At X_{OUT}			-6.5		mV
At Y_{OUT}			6.5		mV
At Z_{OUT}			11.5		mV
OUTPUT AMPLIFIER	No load				
Output Swing Low			0.1		V
Output Swing High			2.8		V
POWER SUPPLY					
Operating Voltage Range ⁷		1.8	3.0	3.6	V
Supply Current	$V_S = 3\text{ V}$		300		μA
Turn-On Time ⁸	No external filter		1		ms
OPERATING TEMPERATURE RANGE		-40		+85	°C

¹ Defined as coupling between any two axes.

² Sensitivity is essentially ratiometric to V_S .

³ Defined as the output change from ambient temperature to maximum temperature or from ambient temperature to minimum temperature.

⁴ Actual frequency response controlled by user-supplied external filter capacitors (C_X , C_Y , and C_Z).

⁵ Bandwidth with external capacitors = $1/(2\pi \times 32\text{ k}\Omega \times C_X)$.

⁶ Self-test response changes cubically with V_S .

⁷ Tested at 3.0 V and guaranteed by design only (not tested) to work over the full voltage range from 1.8 V to 3.6 V.

⁸ Turn-on time is dependent on C_X , C_Y , and C_Z and is approximately $160 \times (C_X \text{ or } C_Y \text{ or } C_Z) + 1$, where C_X , C_Y , and C_Z are in μF and the resulting turn-on time is in ms.

ABSOLUTE MAXIMUM RATINGS

Table 2.

Parameter	Rating
Acceleration (Any Axis)	
Unpowered	10,000 <i>g</i>
Powered	10,000 <i>g</i>
V_S	-0.3 V to +3.6 V
All Other Pins	(GND - 0.3 V) to ($V_S + 0.3$ V)
Output Short-Circuit Duration (Any Pin to Ground)	Indefinite
Operating Temperature Range	-55°C to +125°C
Storage Temperature Range	-65°C to +150°C

Stresses above those listed under Absolute Maximum Ratings may cause permanent damage to the device. This is a stress rating only; functional operation of the device at these or any other conditions above those indicated in the operational section of this specification is not implied. Exposure to absolute maximum rating conditions for extended periods may affect device reliability.

ESD CAUTION



ESD (electrostatic discharge) sensitive device. Charged devices and circuit boards can discharge without detection. Although this product features patented or proprietary protection circuitry, damage may occur on devices subjected to high energy ESD. Therefore, proper ESD precautions should be taken to avoid performance degradation or loss of functionality.

PIN CONFIGURATION AND FUNCTION DESCRIPTIONS

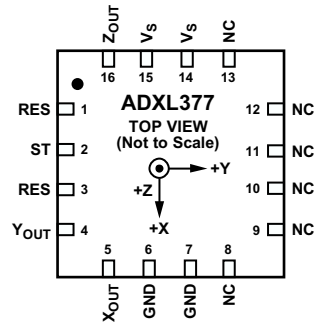

- NOTES**
 1. NC = NO CONNECT.
 2. THE EXPOSED PAD IS NOT INTERNALLY CONNECTED, BUT SHOULD BE SOLDERED FOR MECHANICAL INTEGRITY.

107785-002

Figure 2. Pin Configuration

Table 3. Pin Function Descriptions

Pin No.	Mnemonic	Description
1, 3	RES	Reserved. This pin must be connected to GND or left open.
2	ST	Self-Test.
4	Y _{OUT}	Y Channel Output.
5	X _{OUT}	X Channel Output.
6, 7	GND	Must be connected to ground.
8 to 13	NC	No Connect. Not internally connected.
14, 15	V _S	Supply Voltage. 3.0 V typical.
16	Z _{OUT} EPAD	Z Channel Output. Exposed Pad. The exposed pad is not internally connected, but should be soldered for mechanical integrity.

TYPICAL PERFORMANCE CHARACTERISTICS

N > 250 for all typical performance figures, unless otherwise noted. N is the number of parts tested and used to produce the histograms.

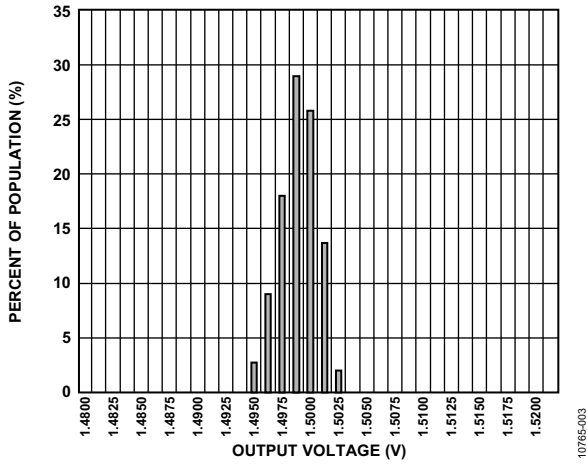

Figure 3. X-Axis Zero g Output Voltage at 25°C, $V_S = 3 V$

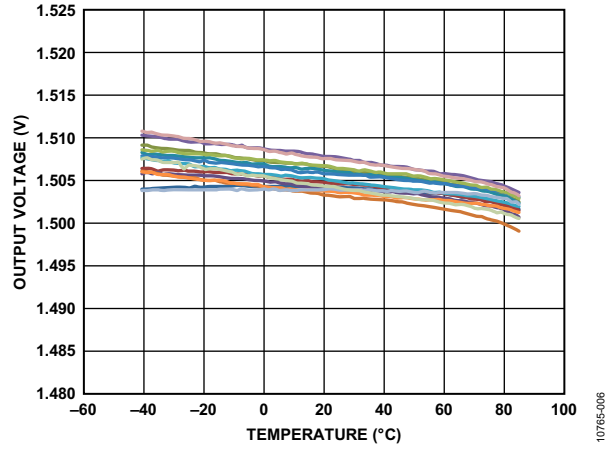

Figure 6. X-Axis Zero g Offset vs. Temperature, $V_S = 3 V$
(14 Parts Soldered to PCB)

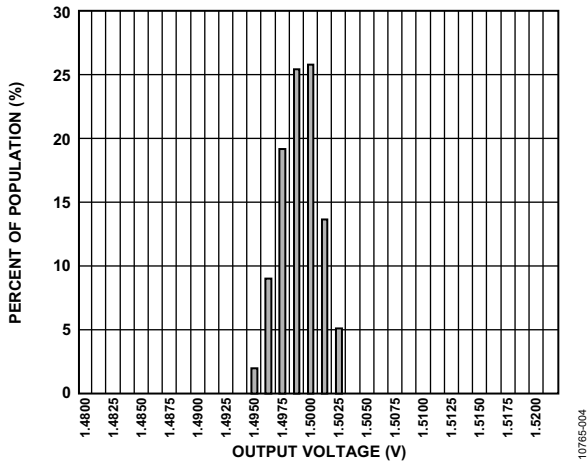

Figure 4. Y-Axis Zero g Output Voltage at 25°C, $V_S = 3 V$

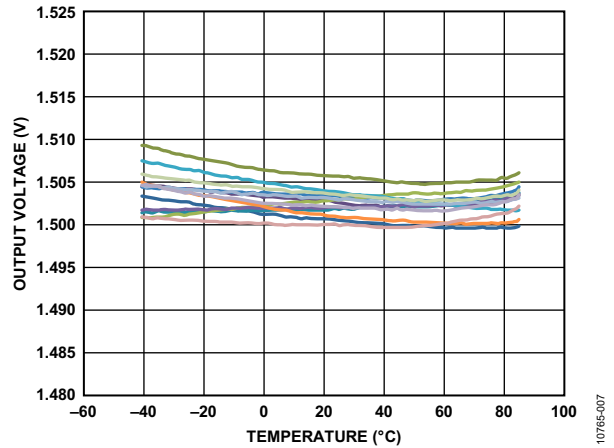

Figure 7. Y-Axis Zero g Offset vs. Temperature, $V_S = 3 V$
(14 Parts Soldered to PCB)

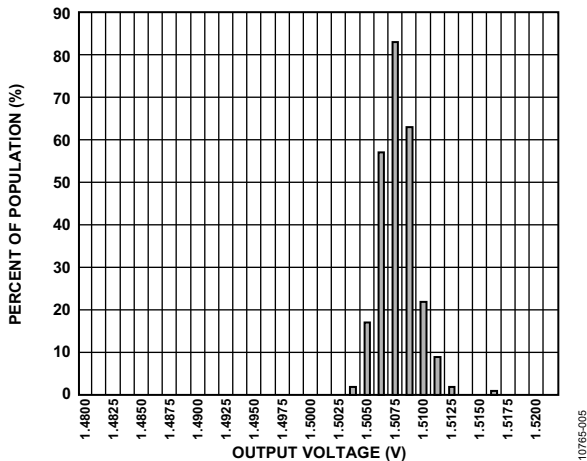

Figure 5. Z-Axis One g Output Voltage at 25°C, $V_S = 3 V$

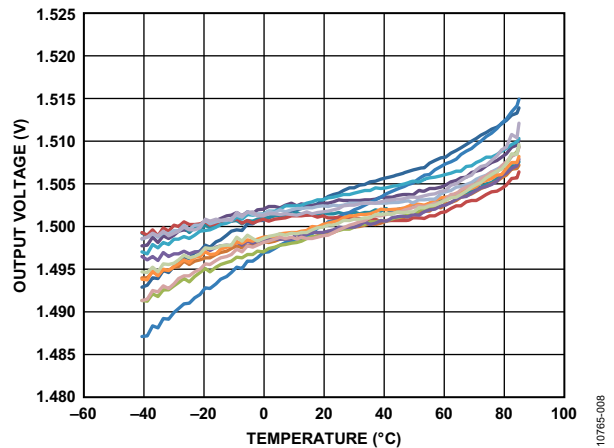

Figure 8. Z-Axis Zero g Offset vs. Temperature, $V_S = 3 V$
(14 Parts Soldered to PCB)

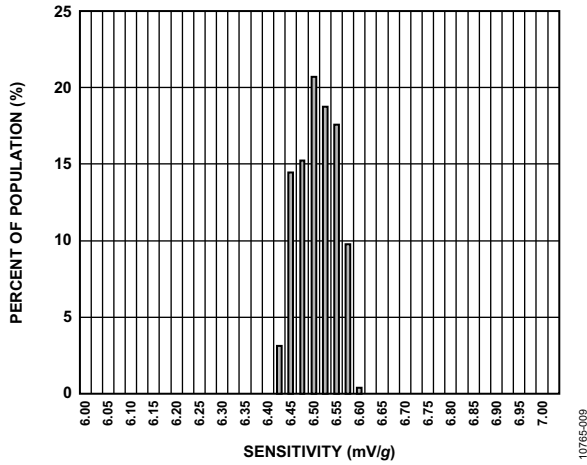

Figure 9. X-Axis Sensitivity at 25°C, $V_S = 3V$

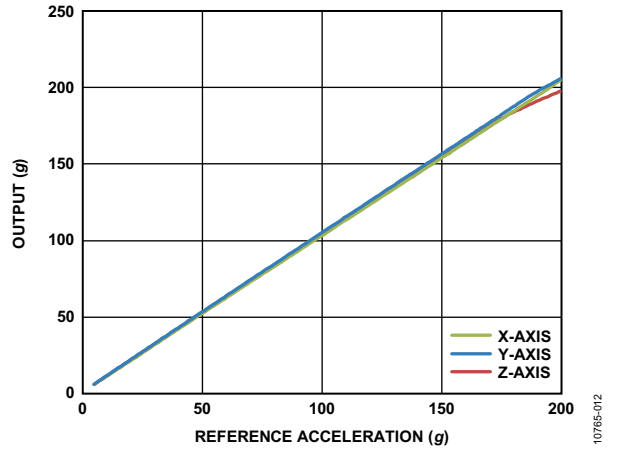

Figure 12. Typical Output Linearity over the Dynamic Range

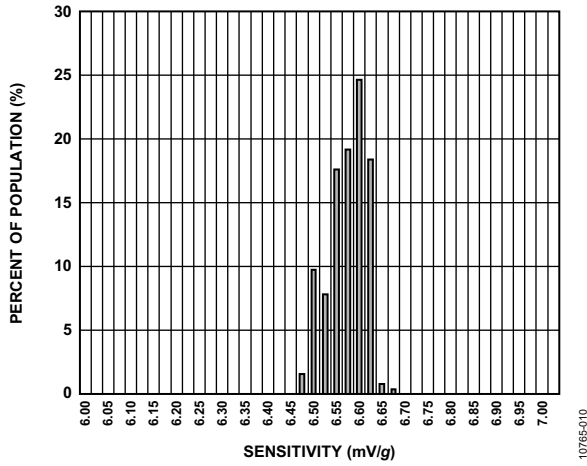

Figure 10. Y-Axis Sensitivity at 25°C, $V_S = 3V$

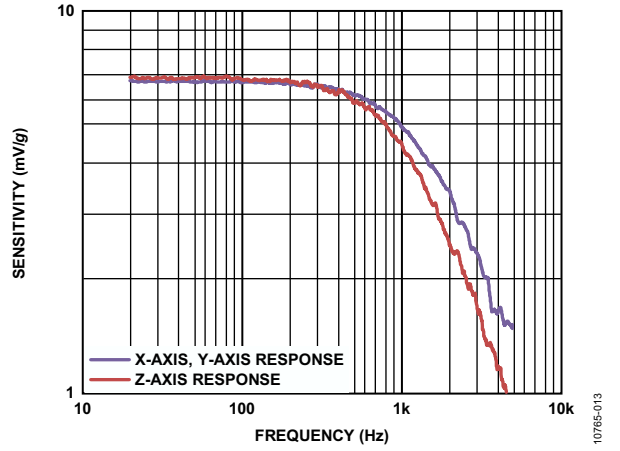

Figure 13. Typical Frequency Response

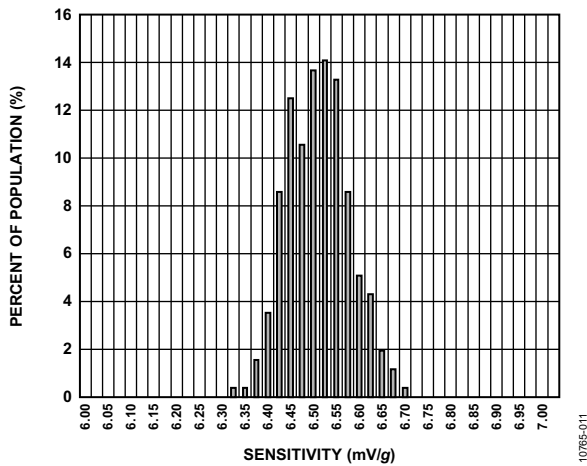

Figure 11. Z-Axis Sensitivity at 25°C, $V_S = 3V$

THEORY OF OPERATION

The [ADXL377](#) is a complete 3-axis acceleration measurement system with a typical measurement range of ± 200 g. The [ADXL377](#) contains a polysilicon, surface-micromachined sensor and signal conditioning circuitry to implement an open-loop acceleration measurement architecture. The output signals are analog voltages that are proportional to acceleration. The accelerometer can measure the static acceleration of gravity in tilt-sensing applications, as well as dynamic acceleration resulting from motion, shock, or vibration.

The sensor is a polysilicon, surface-micromachined structure built on top of a silicon wafer. Polysilicon springs suspend the structure over the surface of the wafer and provide resistance against acceleration forces. Deflection of the structure is measured using a differential capacitor that consists of independent fixed plates and plates attached to the moving mass. The fixed plates are driven by 180° out-of-phase square waves. Acceleration deflects the moving mass and unbalances the differential capacitor, resulting in a sensor output whose amplitude is proportional to acceleration. Phase-sensitive demodulation techniques are then used to determine the magnitude and direction of the acceleration.

The demodulator output is amplified and brought off chip through a 32 k Ω resistor. The user then sets the signal bandwidth of the device by adding a capacitor. This filtering improves measurement resolution and helps prevent aliasing.

MECHANICAL SENSOR

The [ADXL377](#) uses a single structure for sensing the acceleration in the x-axis, y-axis, and z-axis. As a result, the three sense directions are highly orthogonal with little cross-axis sensitivity. Mechanical misalignment of the sensor die to the package or misalignment of the package to the PCB is the chief source of cross-axis sensitivity. Mechanical misalignment can be calibrated at the system level.

PERFORMANCE

Rather than using additional temperature compensation circuitry, the [ADXL377](#) uses innovative design techniques to ensure high performance. As a result, there is neither quantization error nor nonmonotonic behavior, and temperature hysteresis is very low.

APPLICATIONS INFORMATION

POWER SUPPLY DECOUPLING

For most applications, a single 0.1 μF capacitor, C_{DC} , placed close to the ADXL377 supply pins adequately decouples the accelerometer from noise on the power supply. However, in applications where noise is present at the 50 kHz internal clock frequency (or any harmonic thereof), additional care in power supply bypassing is required because this noise can cause errors in acceleration measurement.

If additional decoupling is needed, a 100 Ω (or smaller) resistor or ferrite bead can be inserted in the supply line. In addition, a larger bulk bypass capacitor (1 μF or greater) can be added in parallel to C_{DC} . Ensure that the connection from the ADXL377 ground to the power supply ground is low impedance because noise transmitted through ground has a similar effect as noise transmitted through V_{S} .

SETTING THE BANDWIDTH USING C_x , C_y , AND C_z

The ADXL377 has provisions for band-limiting the X_{OUT} , Y_{OUT} , and Z_{OUT} pins. A capacitor must be added at each of these pins to implement low-pass filtering for antialiasing and noise reduction. The equation for the -3 dB bandwidth is

$$f_{-3\text{ dB}} = 1/(2\pi \times 32\text{ k}\Omega \times C_x)$$

or more simply,

$$f_{-3\text{ dB}} = 5\ \mu\text{F}/C_x$$

The tolerance of the internal resistor (R_{FILT}) typically varies by as much as $\pm 15\%$ of its nominal value (32 k Ω), and the bandwidth varies accordingly. A minimum capacitance of 1000 pF for C_x , C_y , and C_z is recommended in all cases.

Table 4. Filter Capacitor Selection for C_x , C_y , and C_z

Bandwidth (Hz)	Capacitor (μF)
50	0.10
100	0.05
200	0.025
500	0.01
1000	0.005

SELF-TEST

The ST pin controls the self-test feature. When this pin is set to V_{S} , an electrostatic force is exerted on the accelerometer beam. The resulting movement of the beam allows the user to test whether the accelerometer is functional. The typical change in output is -1.08 g (corresponding to -6.5 mV) for the x-axis, $+1.08\text{ g}$ (or $+6.5\text{ mV}$) for the y-axis, and $+1.83\text{ g}$ (or $+11.5\text{ mV}$) for the z-axis. The ST pin can be left open circuit or connected to ground (GND) in normal use.

Never expose the ST pin to voltages greater than $V_{\text{S}} + 0.3\text{ V}$. If the system design is such that this condition cannot be guaranteed (for example, if multiple supply voltages are present), it is recommended that a clamping diode with low forward voltage be connected between ST and V_{S} .

SELECTING FILTER CHARACTERISTICS: NOISE/BANDWIDTH TRADE-OFF

The selected accelerometer bandwidth ultimately determines the measurement resolution (smallest detectable acceleration). Filtering can be used to lower the noise floor, thereby improving the resolution of the accelerometer. Resolution is dependent on the analog filter bandwidth at X_{OUT} , Y_{OUT} , and Z_{OUT} .

The output of the ADXL377 has a typical bandwidth of 1000 Hz. The user must filter the signal at this point to limit aliasing errors. The analog bandwidth must be no more than half the analog-to-digital sampling frequency to minimize aliasing. The analog bandwidth can be decreased further to reduce noise and improve resolution.

The ADXL377 noise has the characteristics of white Gaussian noise, which contributes equally at all frequencies and is described in terms of $\mu\text{g}/\sqrt{\text{Hz}}$ (that is, the noise is proportional to the square root of the accelerometer bandwidth). Limit the bandwidth to the lowest frequency required by the application to maximize the resolution and dynamic range of the accelerometer.

With the single-pole roll-off characteristic, the typical noise of the ADXL377 is determined by

$$\text{rms Noise} = \text{Noise Density} \times (\sqrt{BW \times 1.6})$$

It is often useful to know the peak value of the noise. Peak-to-peak noise can only be estimated by statistical methods. Table 5 can be used to estimate the probability of exceeding various peak values, given the rms value.

Table 5. Estimation of Peak-to-Peak Noise

Peak-to-Peak Value	Percentage of Time That Noise Exceeds Nominal Peak-to-Peak Value (%)
$2 \times \text{rms}$	32
$4 \times \text{rms}$	4.6
$6 \times \text{rms}$	0.27
$8 \times \text{rms}$	0.006

AXES OF ACCELERATION SENSITIVITY

Figure 14 shows the axes of sensitivity for the accelerometer. Figure 15 shows the output response when the accelerometer is oriented parallel to each of these axes.

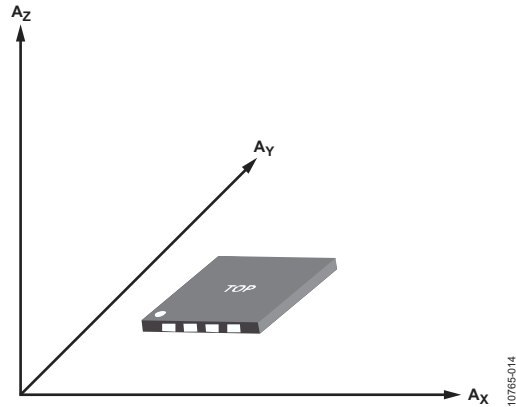

Figure 14. Axes of Acceleration Sensitivity (Corresponding Output Voltage Increases When Accelerated Along the Sensitive Axis)

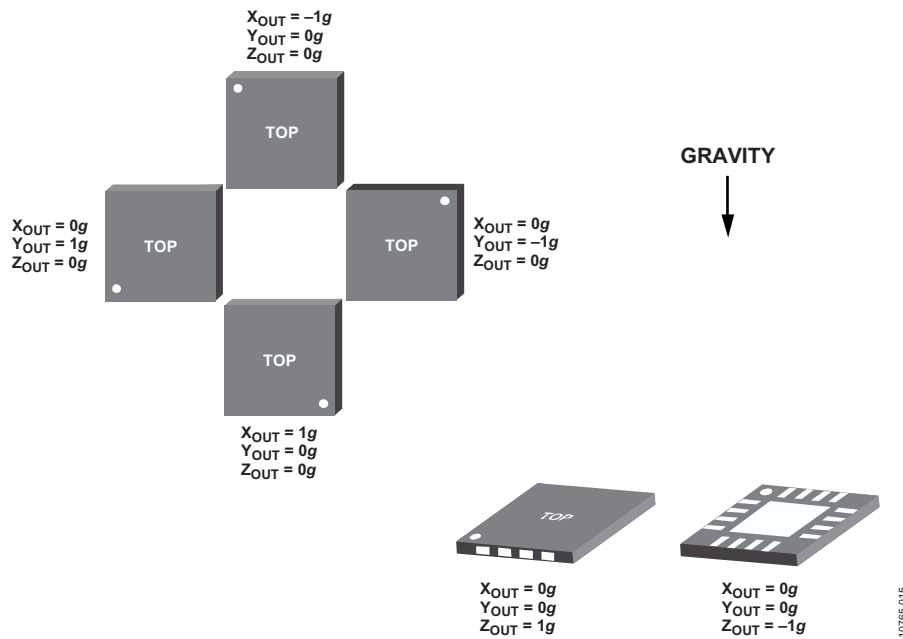

Figure 15. Output Response vs. Orientation to Gravity

LAYOUT AND DESIGN RECOMMENDATIONS

Figure 16 shows the recommended soldering profile; Table 6 describes the profile features. Figure 17 shows the recommended PCB layout or solder land drawing.

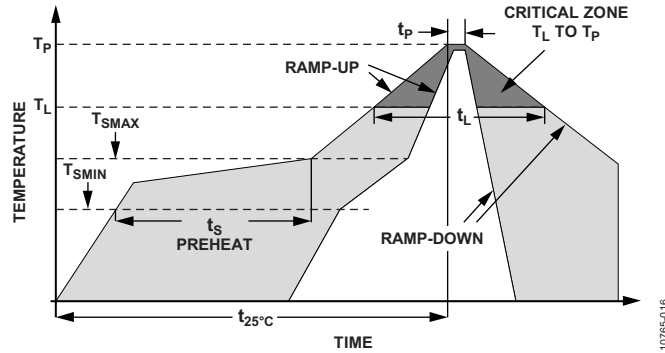

Figure 16. Recommended Soldering Profile

Table 6. Recommended Soldering Profile

Profile Feature	Sn63/Pb37	Pb-Free
Average Ramp Rate (T_L to T_P)	3°C/sec max	3°C/sec max
Preheat		
Minimum Temperature (T_{SMIN})	100°C	150°C
Maximum Temperature (T_{SMAX})	150°C	200°C
Time, T_{SMIN} to T_{SMAX} (t_S)	60 sec to 120 sec	60 sec to 180 sec
Ramp-Up Rate (T_{SMAX} to T_L)	3°C/sec max	3°C/sec max
Time Maintained Above Liquidous (t_L)	60 sec to 150 sec	60 sec to 150 sec
Liquidous Temperature (T_L)	183°C	217°C
Peak Temperature (T_P)	240°C + 0°C/-5°C	260°C + 0°C/-5°C
Time Within 5°C of Actual Peak Temperature (t_P)	10 sec to 30 sec	20 sec to 40 sec
Ramp-Down Rate (T_P to T_L)	6°C/sec max	6°C/sec max
Time 25°C to Peak Temperature ($t_{25°C}$)	6 minutes max	8 minutes max

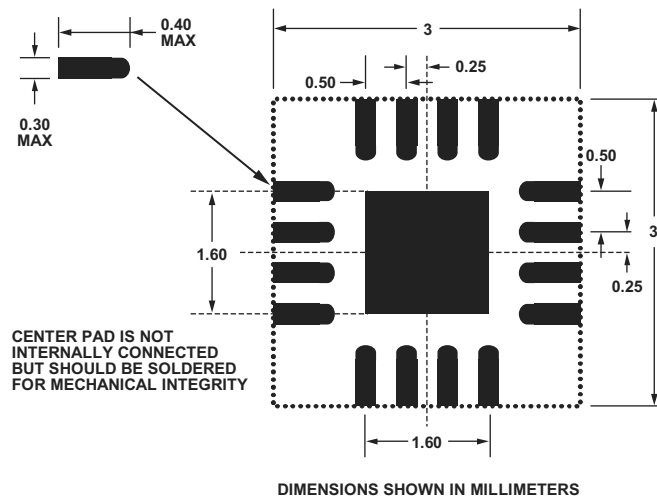

Figure 17. Recommended PCB Layout

OUTLINE DIMENSIONS

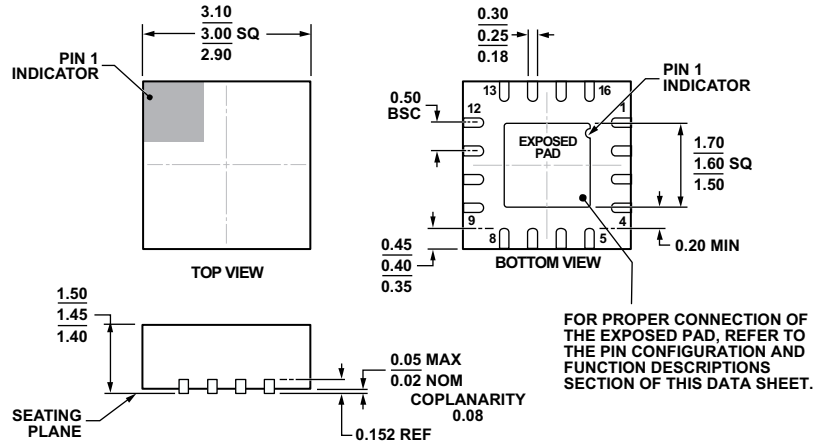

Figure 18. 16-Lead Lead Frame Chip Scale Package [LFCSP_LQ]
 3 mm × 3 mm Body, Thick Quad
 (CP-16-28)
 Dimensions shown in millimeters

ORDERING GUIDE

Model ¹	Measurement Range	Specified Voltage	Temperature Range	Package Description	Package Option	Branding
ADXL377BCPZ-RL	±200 g	3 V	−40°C to +85°C	16-Lead LFCSP_LQ	CP-16-28	Y4P
ADXL377BCPZ-RL7	±200 g	3 V	−40°C to +85°C	16-Lead LFCSP_LQ	CP-16-28	Y4P
EVAL-ADXL377Z				Evaluation Board		

¹ Z = RoHS Compliant Part.