

Subminiature Tachometer Requires No External Power Supply

- Subminiature 48 x 24 mm (1.89 x .94 in)
- Improved noise immunity
- Screw terminal and wire-wrap types available
- DC, and no-voltage input
- Printed circuit board version (H7E□-P)
- Panel adapters for existing cutouts (order separately from accessories)
- Self-powered, 3 V lithium battery



Ordering Information

■ TACHOMETER

Operating mode	UP type						
Display	LCD digital, 5.1 mm (0.2 in) high						
Reset system	Automatic (No external or manual reset)						
Number of digits*	4	5					
Count input	No-voltage input	DC voltage input					
Max. counting speed	1 kcps		10 kcps				
Max. revolutions displayed**	1,000 rps		1,000.0 rps	10,000 rpm	1,000.0 rpm	Selectable***	
Applicable encoder resolution	1 pulse/rev.		10 pulses/rev.	60 pulses/rev.	600 pulses/rev.	Selectable***	
Terminals	Wire-wrap	H7ER	H7ER-V	H7ER-V1	H7ER-V2	H7ER-V3	—
	Screw	H7ER-B	H7ER-BV	H7ER-BV1	H7ER-BV2	H7ER-BV3	H7ER-SBV

* When there is no input, 0.0 or 0 is displayed.

** The maximum number of revolutions which may be displayed depends on the output specification of the encoder to be used.

*** Many kinds of encoders can be used with H7ER-SBV. Confirm pulse compatibility by referring to specific values listed in "Setting the RPM Display of the H7ER-SBV", in Connections.

■ ACCESSORIES

Description	Part number
Panel adapters	
Fits 26 x 45 mm (1.02 x 1.77 in.) rectangular cutout	Y92F-75
Fits 27.5 x 52.5 mm (1.1 x 2.07 in.) rectangular cutout	Y92F-76
Fits 24.8 x 48.8 mm (0.98 x 1.92 in.) rectangular cutout	Y92F-77

Specifications

■ RATINGS

Supply voltage	H7ER-SBV: 5 to 24 VDC ± 10%, Ripple (p-p): 5% max. DC voltage and No-voltage input types: Not required (powered by built-in battery)
Input	DC voltage input: 4.5 to 30 VDC at "High" (logic) level 0 to 2 VDC at "Low" (logic) level No-voltage input: Maximum short-circuit impedance: 10 kΩ max. Short-circuit residual voltage: 0.5 V max. Minimum open impedance: 500 kΩ min.
Maximum counting speed	1 kcps (gate time: 1 second) 10 kcps (gate time: 1 second)
Reset time	Automatic (no external or manual reset)

Approved by the following standards

- UL
- CSA
- CE (EMC)

■ CHARACTERISTICS

Insulation resistance	100 MΩ min. at 500 VDC
Dielectric strength	1,000 VAC 50/60 Hz for 1 minute between current-carrying terminals and exposed non-current-carrying metal parts
Vibration	Mechanical durability: 10 to 55 Hz; 0.75 mm (0.03 in) double amplitude Malfunction durability: 10 to 55 Hz; 0.3 mm (0.02 in) double amplitude
Shock	Mechanical durability: Approx. 30 G Malfunction durability: Approx. 10 G
Ambient temperature	Operating: -10° to 55°C (14° to 131°F) Storage: -25° to 65°C (-13° to 149°F)
Humidity	Operating: 35 to 85% RH
Battery life	7 years min. of continuous operation
Weight	H7ER-SBV: approx. 80 g (2.82 oz) DC voltage & No-voltage input types: approx. 60 g (2.12 oz) (including mounting bracket)

Timing Chart

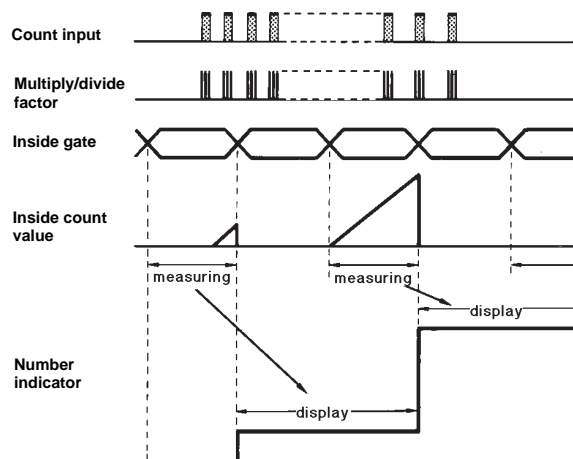

Dimensions

Unit: mm(inch)

■ SCREW TERMINAL TACHOMETERS

No-voltage and DC Input Types

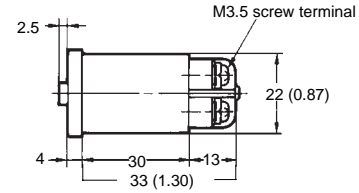
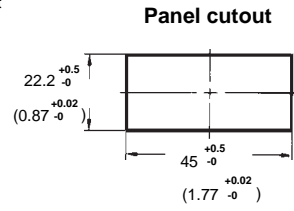
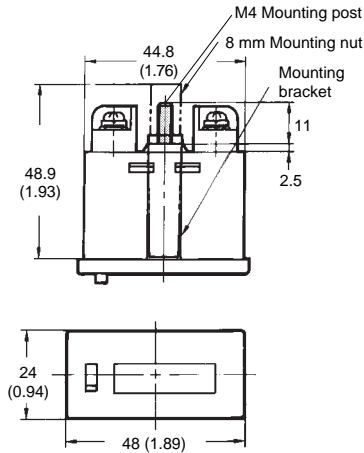
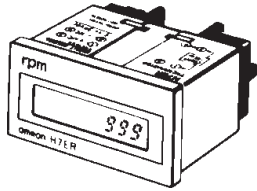

AC/DC Voltage Input Type

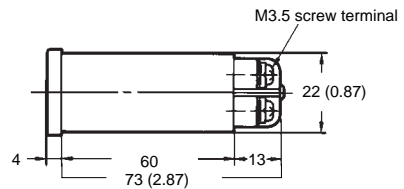
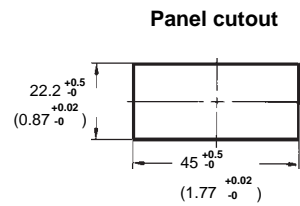
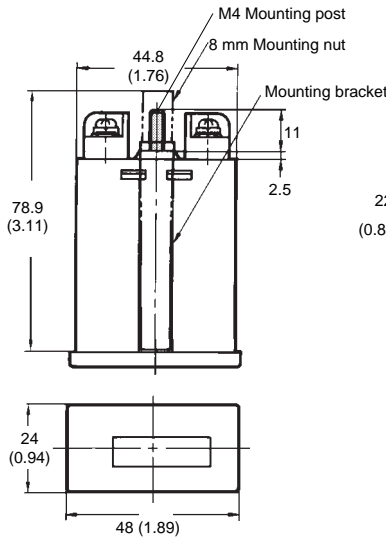
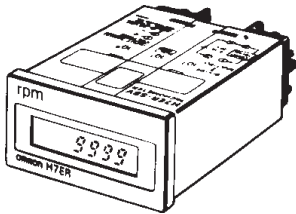

■ WIRE-WRAP TERMINAL TACHOMETERS

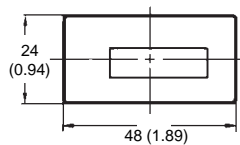
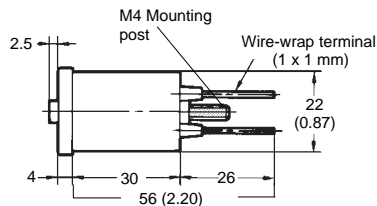
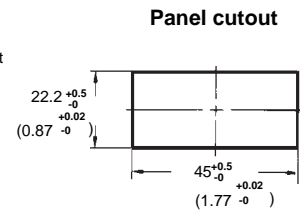
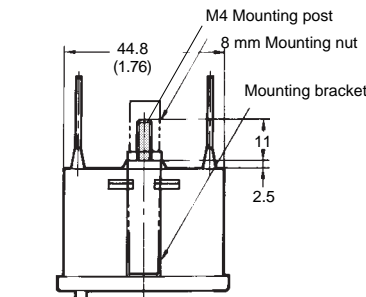
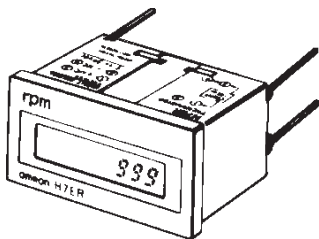

Mounting holes and footprint

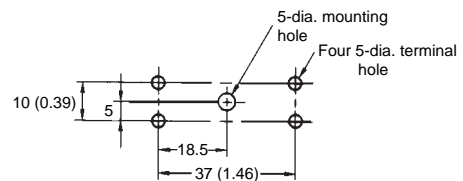

■ PANEL MOUNTING ADAPTERS

Y92F-75

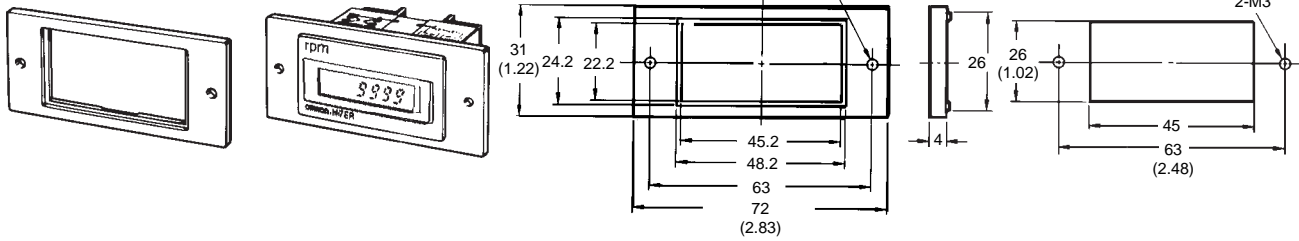

Y92F-76

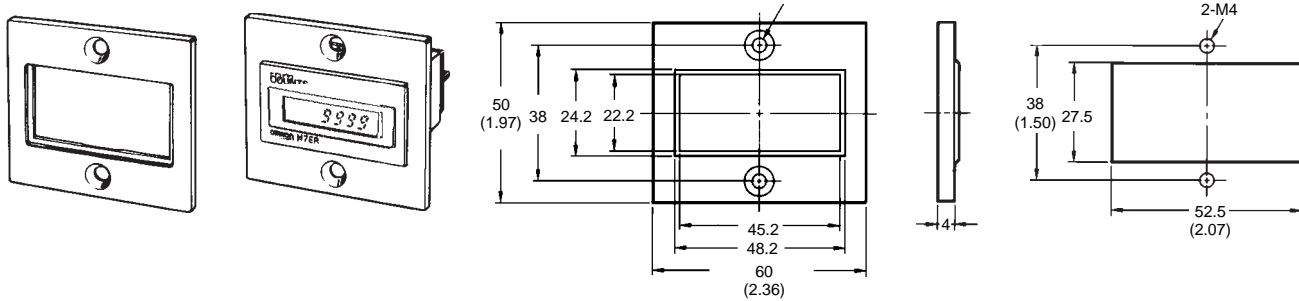

Y92F-77

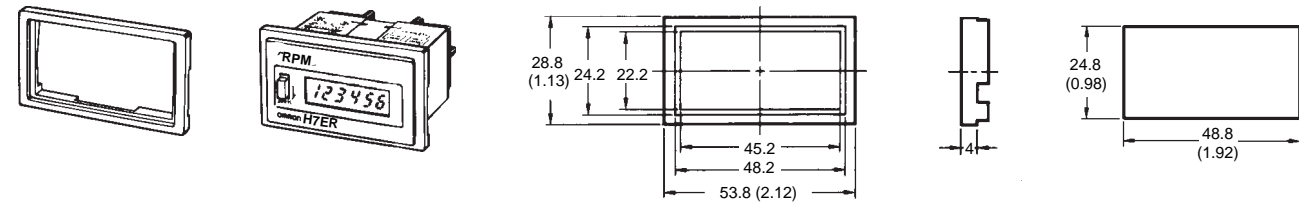

Connections

■ NO-VOLTAGE INPUT TYPE

Solid-state input (open collector input of an NPN transistor)

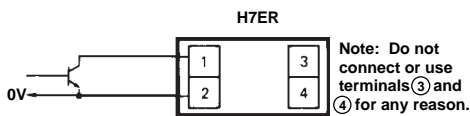

■ DC VOLTAGE INPUT TYPE

Solid-state input (open collector input of an NPN transistor)

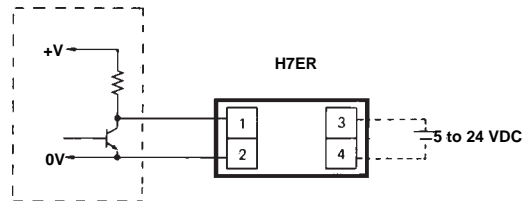

Note: When using H7ER-SBV, connect an external power supply as shown by the dotted line. Other than that, do not connect or use terminals ③ or ④ for any reason.

SETTING THE RPM DISPLAY OF THE H7ER-SBV

The model H7ER-SBV Tachometer can display the rotating speed of different encoders in either revolutions per second or per minute.

The tachometer is set by using a sliding selector switch and three selectors, located under a flip-up cover on the tachometer. Settings and accurately-displayed values depend upon the revolutions output of encoder.

To access the switches, press the tachometer cover near the hinged cover.

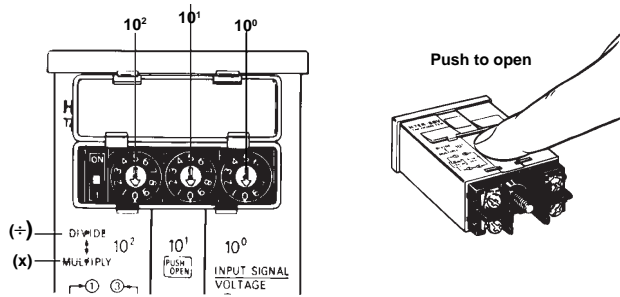

Refer to table below to set tachometer.

SETTING PROCEDURE

The table below shows the proper tachometer settings for the most common encoder resolutions.

Unit	Encoder resolution A	Tachometer settings	Revolutions		
			Rmin	Rmax	
rps	1	DIVIDE	0	1	10,000
	10	DIVIDE	0	1	1,000
	20	DIVIDE	0	2	500
	30	DIVIDE	0	3	333
	60	DIVIDE	0	6	166
	100	DIVIDE	1	0	100
	120	DIVIDE	1	2	83
	200	DIVIDE	2	0	50
	360	DIVIDE	3	6	27
	600	DIVIDE	6	0	16
rpm	1	MULTIPLY	0	6	10,000
	10	MULTIPLY	0	0	10,000
	20	MULTIPLY	0	0	10,000
	30	MULTIPLY	0	0	10,000
	60	DIVIDE	0	0	10,000
	120	DIVIDE	0	0	5,000
	180	DIVIDE	0	0	3,333
	240	DIVIDE	0	0	2,500
	300	DIVIDE	0	0	2,000
	360	DIVIDE	0	0	1,666
	420	DIVIDE	0	0	1,428
	480	DIVIDE	0	0	1,250
	540	DIVIDE	0	0	1,111
	600	DIVIDE	0	1	1,000

For example, if the encoder you plan to use has a resolution of 180, and you desire the tachometer to display revolutions per minute, set the tachometer to display revolutions per minute using the following settings:

- DIVIDE/MULTIPLY switch: DIVIDE
- Left selector (10²): 0
- Center selector (10¹): 0
- Right selector (10⁰): 3

In this example, the tachometer display will read accurately from 1 to 3,333 rpm. Should the encoder input be outside this range, the tachometer readout will be inaccurate.

CALCULATING TACHOMETER SETTINGS

If the encoder you plan to use has a resolution not listed in the table, it will be necessary to calculate the tachometer switch settings.

RPS settings

If the tachometer is to display rps, set the DIVIDE/MULTIPLY switch to DIVIDE. The selector settings correspond exactly to the resolution value of the encoder.

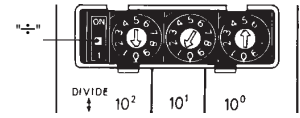

For example, if the encoder you plan to use has a resolution of 287, and you desire the tachometer to display in units of revolutions per second display, set the tachometer switches as follows:

- DIVIDE/MULTIPLY switch: DIVIDE
- Left selector (10²): 2
- Center selector (10¹): 8
- Right selector (10⁰): 7

RPM settings

For the tachometer to display rpm, the encoder resolution value must be a factor of 60, or divisible evenly into 60, and equal to or greater than 60.

When the resolution of the encoder is less than 60, set the DIVIDE/MULTIPLY switch to MULTIPLY.

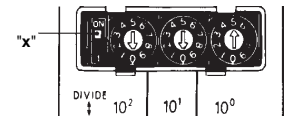

Calculate the selector settings with the following formula:

$$B = 60 \div A$$

where: B = value to be set on the selector switches
A = resolution of the encoder

For example, if the encoder has a resolution of 5, the calculation would be:

$$60 \div 5 = 12$$

thus, the tachometer settings would be:

- DIVIDE/MULTIPLY switch: MULTIPLY
- Left selector (10²): 0
- Center selector (10¹): 1
- Right selector (10⁰): 2

When the resolution of the encoder is equal to, or greater than 60, set the DIVIDE/MULTIPLY switch to DIVIDE.

Calculate the DIP switch settings with the following formula:

$$B = A \div 60$$

For example, if the encoder has a resolution of 720, the calculation would be:

$$720 \div 60 = 12$$

thus, the tachometer settings would be:

- DIVIDE/MULTIPLY switch: DIVIDE
- Left selector (10²): 0
- Center selector (10¹): 1
- Right selector (10⁰): 2

Calculating minimum (Rmin) and maximum (Rmax) revolutions

In all of the above cases, the number of revolutions the encoder transmits must fall within a calculated minimum and maximum range. If the encoder's output exceeds or falls below this range, the number of revolutions will not be displayed accurately. Also, the tachometer cannot represent values greater than 10,000, even if the calculated value indicates otherwise.

Calculating the maximum number of revolutions (Rmax)

When displaying in rpm:

$$R_{max} = 10,000 \times 60/A \text{ (rpm) or } 10,000 \text{ (rpm), whichever is smaller.}$$

When displaying in rps,

$$R_{max} = 10,000/A \text{ (rps)}$$

Calculating the minimum number of revolutions (Rmin)

With selector switch at DIVIDE position

$$R_{min} = 1 \text{ (rpm or rps)}$$

With selector switch at MULTIPLY position

$$R_{min} = 60/A \text{ (rpm)}$$

Installation

■ WIRE-WRAP TERMINALS

The terminals used on H7E wire-wrap models have a cross sectional dimension of 1 x 1 mm. Select one of the three gauges of wire from the table at right. Also listed in the table are the appropriate wiring hardware.

Wire gauge	Bit	Sleeve	Method
AWG22	2-A	2-B	Normal wire-wrap
AWG24	1-A	1-B	Normal wire-wrap
AWG26	3-A	3-B	Normal wire-wrap

■ CAUTIONS CONCERNING THE H7ER TACHOMETER

On some H7E models, the power input terminal and the common signal input terminal (terminals 2 and 4) are internally short-circuited. Pay special attention to polarity when wiring these terminals.

Keep the input wiring as short as possible.

Whenever possible, avoid routing the input wiring of the AC/DC voltage input type in parallel with 200 to 240 VAC power lines.

If the input wiring must be routed together with the power lines, keep the length of that portion of wire running parallel with the power lines to within 20 m (65.6 feet).

When using shielded wire, stray capacitance may occur. The operation of the tachometer might be affected when using wires which have a capacitance which exceeds 500 pF (about 10 m, 32.8 feet, with parallel wires of 2 mm²). Keep all wires as short as possible.

■ HOW TO MOUNT THE TACHOMETER

Insert the H7ER tachometer from the front of the mounting panel. Slide the mounting bracket into place from the rear of the panel, and tighten the knurled nut by hand. Do not use tools (such as pliers) to tighten the nut. Excessive tightening may damage the tachometer. Wire-wrap terminal models may be back-mounted, by soldering the terminals to a printed circuit board.

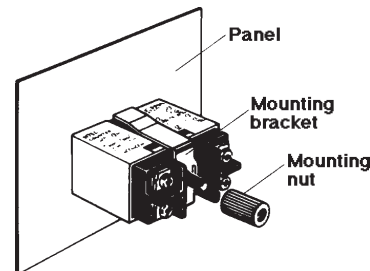

NOTE: DIMENSIONS SHOWN ARE IN MILLIMETERS. To convert millimeters to inches, divide by 25.4.

OMRON

OMRON ELECTRONICS, INC.

One East Commerce Drive
Schaumburg, IL 60173
1-800-55-OMRON

OMRON CANADA, INC.

885 Milner Avenue
Scarborough, Ontario M1B 5V8
416-286-6465