

BIAS TEES

7/16 - DIN, up to 7.5 GHz, 100 Volts / 2.5 Amps

SPECIFICATIONS:

Models: 8800DMFX-yy, 8800DFFX-yy, 8800DMMX-yy, 8800DFMX-yy

RoHS
Compliant



Electrical:

Frequency Range	10 MHz - 7.5 GHz	
Standard Freq. Values	2.5, 4, 6 & 7.5 GHz	
Insertion Loss	Typical	Maximum
10 MHz - 30 MHz	1.00 dB	1.25 dB
30 MHz - 2.5 GHz	0.50 dB	1.00 dB
2.5 - 6 GHz	1.25 dB	1.50 dB
6 - 7.5 GHz	1.50 dB	2.00 dB
VSWR	Typical	Maximum
30 MHz - 2.5 GHz	1.40:1	1.50:1
2.5 GHz - 4 GHz	1.30:1	1.50:1
4 - 6 GHz	1.40:1	1.50:1
6 - 7.5 GHz	1.50:1	1.80:1
Isolation (RF to Bias Port)	> 30dB Typ.	
3dB Bandwidth	5 MHz - 7.5 GHz	
Impedance	50 Ohms	
Bias-Path Resistance	0.04 Ohms Typ., 0.05 Ohms Max.	
DC Voltage	100 VDC Max.	
DC Current	2.5 Amps Max.	
RF Power	5 Watts Max	
Current Rating vs Temperature	See Graph	

Environmental

Operating Temperature Range	-55°C to +105°C
Storage Temperature Range	-60°C to +90°C

Mechanical:

7/16 DIN Connectors	Silver or White Bronze Plated Brass
Mates with DIN 47 223	
SMA Connectors	Passivated Stainless Steel
Mates with MIL-STD-348	ed Beryllium Copper
BNC Connectors	Nickel Plated Brass
Mates with MIL-STD-348	
Conductors	Silver, Gold or White Bronze Plated Beryllium Copper
Body	Aluminum with Chemical Conversion Coating

Typical performance from 5 MHz - 9 GHz

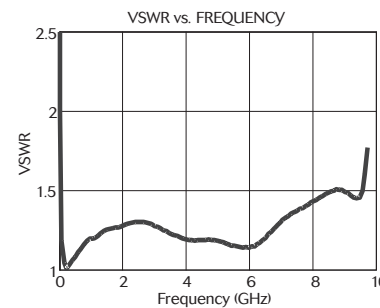
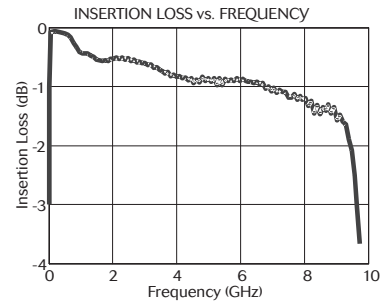

DC Input Connector		
X=1 Solder Post	X=3 BNC Female	
Model Numbers	Connector Configuration Port	
	AC + DC	AC
8820DMFX-02	Male	Female
8820DFFX-02	Female	Female
8820DMMX-02	Male	Male
8820DFMX-02	Female	Male

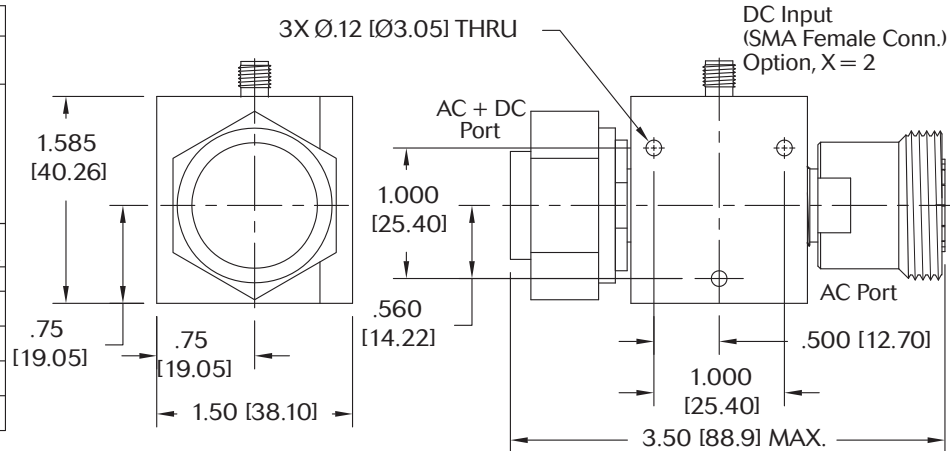

HOW TO ORDER:

Model Number: **8800DZZX-yy**
 Base Number | Freq. Range
 DC Connector Type | 02 = 10 MHz - 2.5 GHz
 1 = Solder Post | 04 = 10 MHz - 4 GHz
 2 = SMA Female Conn. | 06 = 10 MHz - 6 GHz
 3 = BNC Female Conn. | 07 = 7.5 GHz

Ordering Examples:

Model Number: **8800DF2-02**
 10 MHz - 2.5 GHz, DIN 7/16 Fem/Fem
 SMA Female DC Connector Type
 Model Number: **8800DMF1-06**
 10 MHz - 6 GHz, DIN 7/16 Male/Fem
 Solder Post DC Connector Type

Note: Dimensions in Brackets are Expressed in Millimeters and are for Reference Only. Design, specifications are subject to change without notice. Contact factory for technical specifications before purchasing and/or use.

8800D: REV F



Aeroflex / Inmet, Inc. • 300 Dino Drive, Ann Arbor, MI 48103 • U.S.A.
 888-244-6638 or 734-426-5553 • FAX: 734-426-5557
 www.aeroflex.com/inmet • inmet@aeroflex.com

PROPRIETARY NOTICE

THE INFORMATION CONTAINED IN THIS DRAWING IS PROPRIETARY AND SHALL NOT BE USED OR DISCLOSED WITHOUT THE PRIOR WRITTEN PERMISSION OF AEROFLEX/INMET INC.

REVISIONS

LTR	DESCRIPTION	DATE	DCN NO.
E	SEE REVISION HISTORY	2/1/08	07-00521

ADDITIONAL INFORMATION

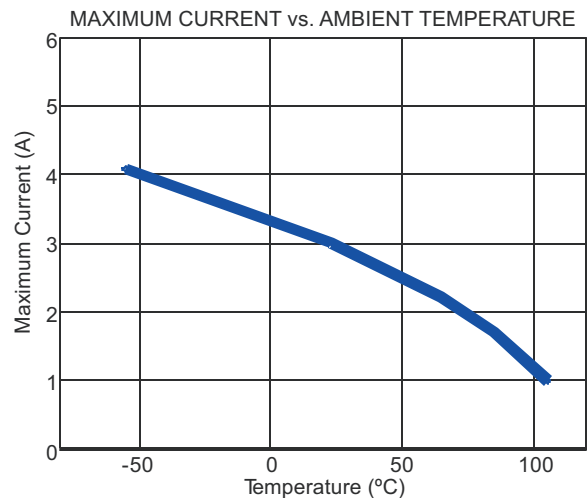
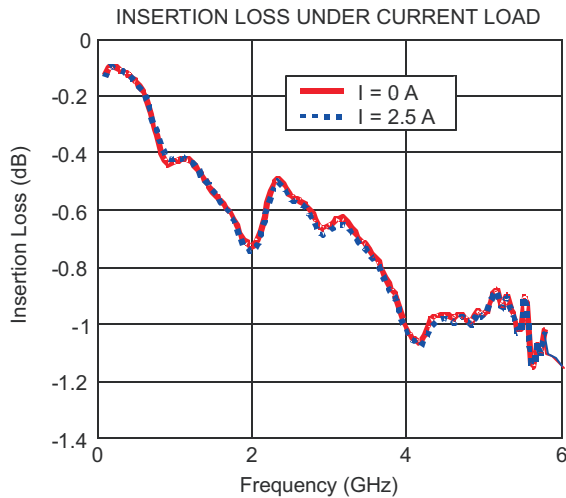
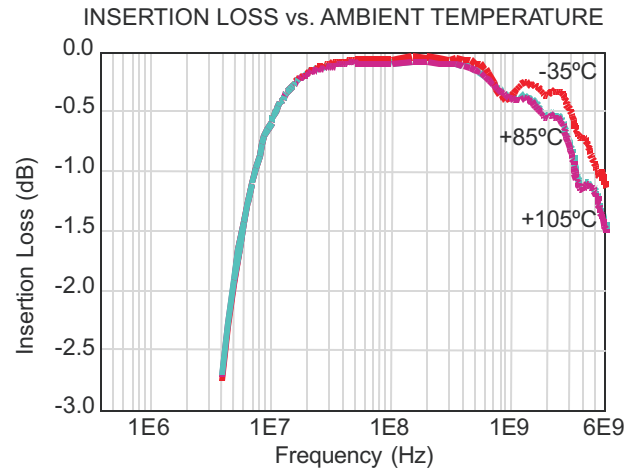
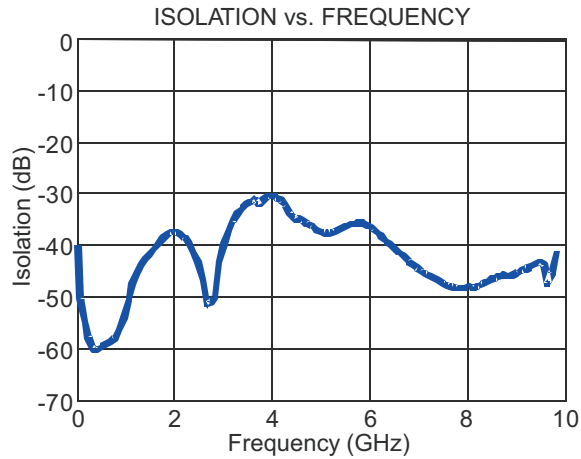

NOTE: DIMENSIONS IN BRACKETS ARE EXPRESSED IN MILLIMETERS AND ARE FOR REFERENCE ONLY.

UNLESS OTHERWISE SPECIFIED DIMENSIONS ARE IN INCHES TOLERANCES DECIMAL .XX ± .01 ANGULAR .XXX ± .005 DO NOT SCALE DRAWING	CONTRACT NO.			300 DINO DRIVE ANN ARBOR, MI 48103 TELEPHONE (734) 426-5553 FACSIMILE (734) 426-5557		
	CHECKED EJM	DATE 10/10/02		TITLE: OUTLINE DRAWING, BIAS TEE, DIN 7/16 CONNECTORS 10 MHz - 7.5GHz, 50 OHM 8800DXXZ-YY SERIES		
MATERIAL:	ENGINEERING EA	DATE 10/11/02	SIZE A	FSCM NO. 64671	DWG. NO. 8800D	
FINISH	MANUFACTURING RB	DATE 10/25/02	SCALE 3/4		RELEASE DATE	SHEET 2 OF 2
SIMILAR TO	QUAL ASSURANCE RFF	DATE 10/11/02				
WEIGHT (gr)	MARKETING NH	DATE 10/24/02				