

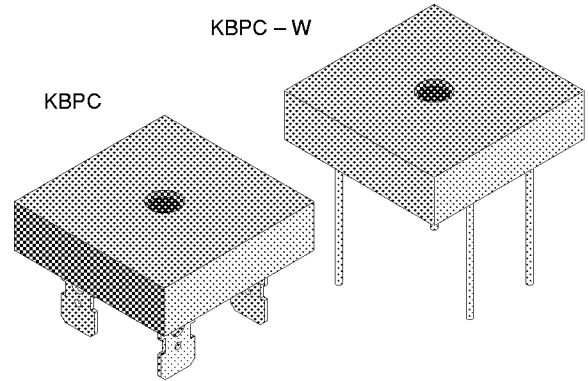

15A Bridge Rectifier

Features

- Diffused junction
- Low reverse leakage current
- Surge overload rating to 300A peak
- Electrically isolated metal case for maximum heat dissipation
- Low power loss, high efficiency
- Case to terminal isolation voltage 2500V
- This series is UL Listed under recognized component index, file number E95060



14 453

Absolute Maximum Ratings

$T_j = 25^\circ\text{C}$

Parameter	Test Conditions	Type	Symbol	Value	Unit
Repetitive peak reverse voltage =Working peak reverse voltage =DC Blocking voltage		KBPC15005/W	V_{RRM} $=V_{RWM}$ $=V_R$	50	V
		KBPC1501/W		100	V
		KBPC1502/W		200	V
		KBPC1504/W		400	V
		KBPC1506/W		600	V
		KBPC1508/W		800	V
		KBPC1510/W		1000	V
Peak forward surge current			I_{FSM}	300	A
Average forward current	$T_C=55^\circ\text{C}$		I_{FAV}	15	A
Junction and storage temperature range			$T_j=T_{stg}$	-65...+150	$^\circ\text{C}$

Electrical Characteristics

$T_j = 25^\circ\text{C}$

Parameter	Test Conditions	Type	Symbol	Min	Typ	Max	Unit
Forward voltage	$I_F=7.5\text{A}$		V_F			1.2	V
Reverse current	$T_C=25^\circ\text{C}$		I_R			10	μA
	$T_C=125^\circ\text{C}$		I_R			1.0	mA
I^2t Rating for fusing			I^2t			373	A^2s
Diode capacitance	$V_R=4\text{V}, f=1\text{MHz}$		C_D		300		pF
Thermal resistance junction to case			R_{thJC}		6.3		K/W



Characteristics ($T_j = 25^\circ\text{C}$ unless otherwise specified)

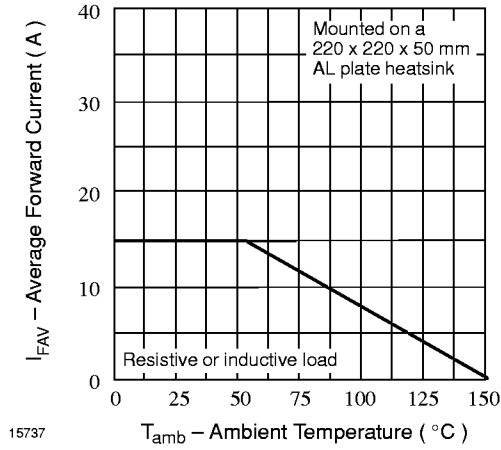

Figure 1. Max. Average Forward Current vs. Ambient Temperature

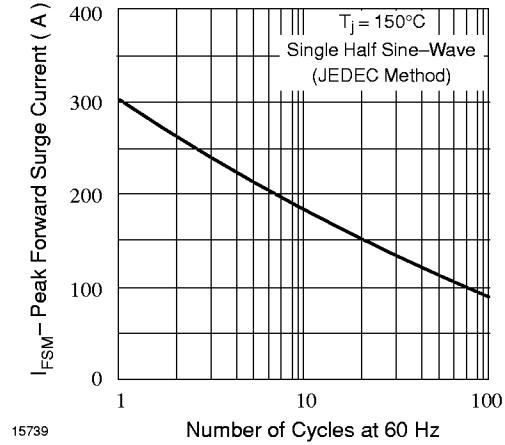

Figure 3. Max. Peak Forward Surge Current vs. Number of Cycles

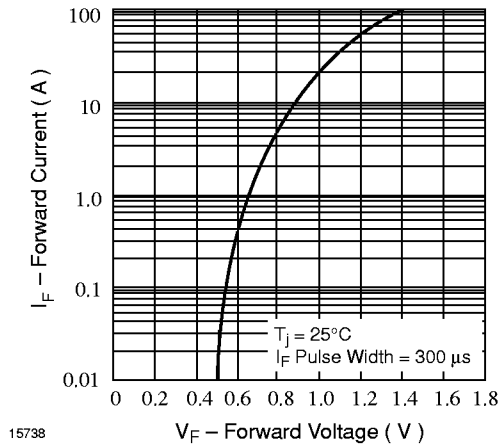

Figure 2. Typ. Forward Current vs. Forward Voltage

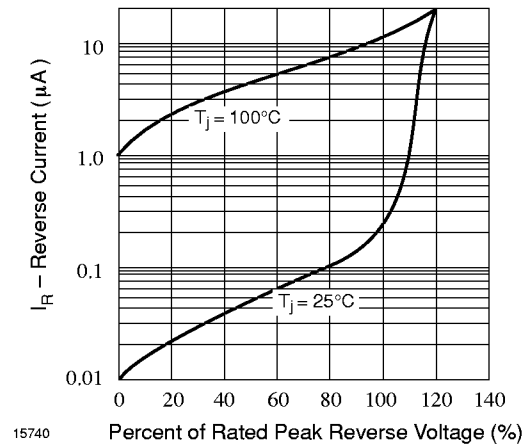

Figure 4. Typ. Reverse Current vs. Percent of Rated Peak Reverse Voltage



KBPC15005/W–KBPC1510/W

Vishay Lite-On Power Semiconductor

Dimensions in mm

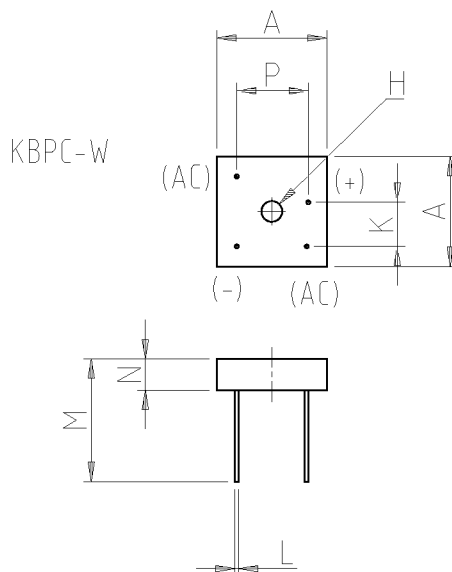
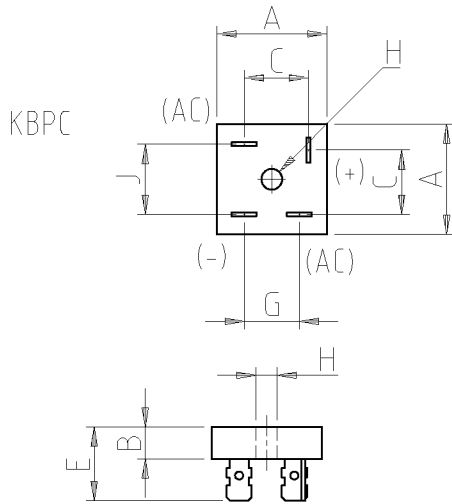

KBPC/KBPC-W		
Dim	Min	Max
A	28.30	28.80
B	7.90	8.40
C	16.10	17.10
E	18.80	21.30
G	13.80	14.80
H	Hole for #10 screw	
	ø5.08	ø5.59
J	17.60	18.60
K	10.90	11.90
L	ø0.97	ø1.07
M	31.80	
N	7.90	8.40
P	17.60	18.60
All Dimensions in mm		

"W" Suffix Designates Wire Leads
 No Suffix Designates Faston Terminals

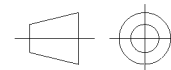

technical drawings
 according to DIN
 specifications

14481

- Case: molded epoxy
- Terminals: plated leads solderable per MIL-STD-202, method 208
- Polarity: symbols marked on case
- Approx. weight: KBPC 31.6 grams,
 KBPC-W 28.5 grams
- Mounting: through hole for #10 screw
- Mounting torque: 8.0 Inch-pounds maximum
- Mounting position: any
- Marking: type number



Ozone Depleting Substances Policy Statement

It is the policy of **Vishay Semiconductor GmbH** to

1. Meet all present and future national and international statutory requirements.
2. Regularly and continuously improve the performance of our products, processes, distribution and operating systems with respect to their impact on the health and safety of our employees and the public, as well as their impact on the environment.

It is particular concern to control or eliminate releases of those substances into the atmosphere which are known as ozone depleting substances (ODSs).

The Montreal Protocol (1987) and its London Amendments (1990) intend to severely restrict the use of ODSs and forbid their use within the next ten years. Various national and international initiatives are pressing for an earlier ban on these substances.

Vishay Semiconductor GmbH has been able to use its policy of continuous improvements to eliminate the use of ODSs listed in the following documents.

1. Annex A, B and list of transitional substances of the Montreal Protocol and the London Amendments respectively
2. Class I and II ozone depleting substances in the Clean Air Act Amendments of 1990 by the Environmental Protection Agency (EPA) in the USA
3. Council Decision 88/540/EEC and 91/690/EEC Annex A, B and C (transitional substances) respectively.

Vishay Semiconductor GmbH can certify that our semiconductors are not manufactured with ozone depleting substances and do not contain such substances.

We reserve the right to make changes to improve technical design and may do so without further notice.

Parameters can vary in different applications. All operating parameters must be validated for each customer application by the customer. Should the buyer use Vishay-Telefunken products for any unintended or unauthorized application, the buyer shall indemnify Vishay-Telefunken against all claims, costs, damages, and expenses, arising out of, directly or indirectly, any claim of personal damage, injury or death associated with such unintended or unauthorized use.

Vishay Semiconductor GmbH, P.O.B. 3535, D-74025 Heilbronn, Germany
Telephone: 49 (0)7131 67 2831, Fax number: 49 (0)7131 67 2423