



# MIC94161/2/3/4/5

## 3A High-Side Load Switch with Reverse Blocking

### General Description

The MIC94161/2/3/4/5 is a family of high-side load switches designed to operate from 1.7V to 5.5V input voltage. The load switch pass element is an internal 14.5mΩ R<sub>DS(on)</sub> N-Channel MOSFET which enables the device to support up to 3A of continuous current. Additionally, the load switch supports 1.5V logic level control and shutdown features in a tiny 1.5mm × 1mm 6-ball WLCSP package.

The MIC9416x provides reverse current protection when the device is disabled. The device will not allow the flow of current from the output to the input when the device is turned OFF. Additionally, the MIC94161 features overvoltage protection to protect the load when the input voltage is above 4.55V, as well as a precise enable threshold which keeps the MIC94161 in the default OFF state until the EN pin rises above 1.15V.

The MIC94161/2/3/4/5 operating voltage range makes them ideal for Lithium-ion and NiMH/NiCad/Alkaline battery-powered systems, as well as non-battery-powered applications. The devices provide low quiescent current and low shutdown current to maximize battery life.

Datasheets and support documentation are available on Micrel's web site at: [www.micrel.com](http://www.micrel.com).

### Features

- 1.5mm × 1mm 6-ball WLCSP package
- 14.5mΩ R<sub>DS(on)</sub>
- 1.7V to 5.5V input voltage range
- 3A continuous operating current
- Reverse current flow blocking (no “body diode”)
- Internal level shift for CMOS/TTL control logic
- Ultra-low quiescent current
- Micropower shutdown current
- Soft-start: MIC94161/4/5 (2.7ms)
- Load discharge circuit: MIC94162/4
- Ultra-fast turn-off time
- Junction operating temperature from –40°C to +125°C

### Applications

- Solid state drives (SSD)
- Smart phones and tablets
- Personal media players (PMP)
- Ultra mobile PCs
- Portable instrumentation
- GPS modules
- Datacom equipment

### Typical Application

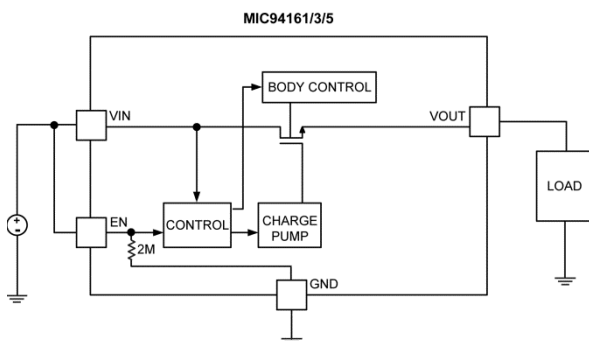

**MIC94161 (2.7ms Soft Start with OVP)**  
**MIC94163 (Ultra-Fast Turn On)**  
**MIC94165 (2.7ms Soft Start)**

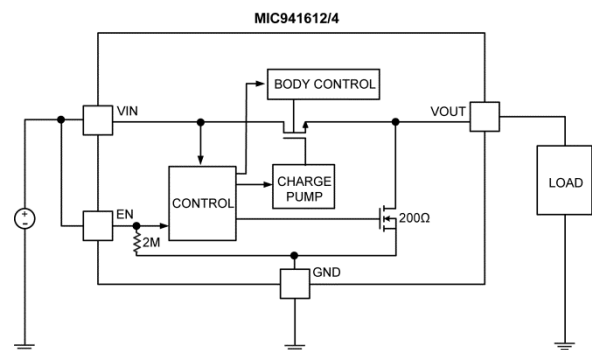

**MIC94162 (Ultra-Fast Turn On with Auto Discharge)**  
**MIC94164 (2.7ms Soft Start with Auto Discharge)**

## Ordering Information

Part Number	Marking	OVP	Turn-On Time	Active Discharge	Package
MIC94161YCS	1Q	Yes	2.7ms	No	1.5mm x 1mm 6-Ball WLCSP
MIC94162YCS	2Q	No	60 $\mu$ s	Yes	1.5mm x 1mm 6-Ball WLCSP
MIC94163YCS	3Q	No	60 $\mu$ s	No	1.5mm x 1mm 6-Ball WLCSP
MIC94164YCS	4Q	No	2.7ms	Yes	1.5mm x 1mm 6-Ball WLCSP
MIC94165YCS	ZQ	No	2.7ms	No	1.5mm x 1mm 6-Ball WLCSP

## Pin Configuration

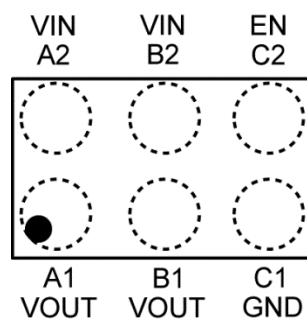

6-Ball 1.5mm x 1mm WLCSP (CS)  
(Top View)

## Pin Description

Pin Number	Pin Name	Pin Function
A1, B1	VOUT	Source of N-channel MOSFET.
C1	GND	Ground.
A2, B2	VIN	Input Supply: Drain of N-channel MOSFET.
C2	EN	Enable (Input): Active-high control input for switch. Internal 2M $\Omega$ pull-down resistor. Output will be off if this pin is left floating.

**Absolute Maximum Ratings<sup>(1)</sup>**

Input Voltage ( $V_{IN}$ )	-0.3V to +6V
Enable Voltage ( $V_{EN}$ )	-0.3V to +6V
Continuous Drain Current ( $I_D$ ) <sup>(3)</sup>	±3A
Storage Temperature ( $T_S$ )	-55°C to +150°C
ESD Rating <sup>(4)</sup>	2kV

**Operating Ratings<sup>(2)</sup>**

Input Voltage ( $V_{IN}$ )	+1.7 to +5.5V
Junction Temperature ( $T_J$ )	-40°C to +125°C
Package Thermal Resistance	
1.5mm × 1mm 6-Ball WLCSP ( $\theta_{JA}$ )	108°C/W

**Electrical Characteristics**

$T_A = 25^\circ\text{C}$ , **bold** values indicate  $-40^\circ\text{C} \leq T_J \leq +125^\circ\text{C}$ , unless noted.

Parameter	Symbol	Condition	Min.	Typ.	Max.	Units
<b>General</b>						
Operating Input Voltage Range	$V_{IN}$		<b>1.7</b>		<b>5.5</b>	V
Enable Threshold Voltage (MIC94161)	$V_{ENTH}$	$V_{IN} = 1.7\text{V to } 5.5\text{V}$ ; $I_{OUT} = 250\mu\text{A}$	<b>1.15</b>		<b>1.5</b>	V
Enable Threshold Voltage (MIC94162/3/4/5)	$V_{ENTH}$	Logic Low, OFF; $V_{IN} = 1.8\text{V to } 5.5\text{V}$ ; $I_{OUT} = 250\mu\text{A}$ ; $-40^\circ\text{C} \geq T_J \geq 85^\circ\text{C}$			<b>0.375</b>	V
		Logic High, ON; $V_{IN} = 1.7\text{V to } 5.5\text{V}$ ; $I_{OUT} = 250\mu\text{A}$ ; $-40^\circ\text{C} \geq T_J \leq 125^\circ\text{C}$	<b>1.2</b>			
Enable Input Current	$I_{EN}$	$V_{IN} = V_{EN} = 3.6\text{V}$ ; $I_{OUT} = 0$		2	4	$\mu\text{A}$
Quiescent Current (MIC94161)	$I_Q$	$V_{IN} = V_{EN} = 3.6\text{V}$ ; $I_{OUT} = 0$		40	<b>80</b>	$\mu\text{A}$
Quiescent Current (MIC94162/3)	$I_Q$	$V_{IN} = V_{EN} = 3.6\text{V}$ ; $I_{OUT} = 0$		25	<b>55</b>	$\mu\text{A}$
Quiescent Current (MIC94164/5)	$I_Q$	$V_{IN} = V_{EN} = 3.6\text{V}$ ; $I_{OUT} = 0$		15	<b>35</b>	$\mu\text{A}$
Shutdown Current	$I_{SD}$	$V_{IN} = 5.5\text{V}$ ; $V_{EN} = 0\text{V}$ ; $I_{OUT} = \text{Open}$		0.1	1	$\mu\text{A}$
OFF State Leakage Current	$I_{LEAK}$	$V_{IN} = 5.5\text{V}$ ; $V_{EN} = 0\text{V}$ ; $I_{OUT} = \text{Short}$		0.1	1	$\mu\text{A}$
Reverse Leakage Current (MIC94161,3,5)	$I_{LEAKR}$	$V_{IN} = 0\text{V}$ ; $V_{OUT} = 5.5\text{V}$ ; $V_{EN} = 0\text{V}$		0.1	1	$\mu\text{A}$
N-Channel ON-Resistance	$R_{DS(ON)}$	$V_{IN} = 5.5\text{V}$ ; $V_{EN} = 1.5\text{V}$ ; $I_{OUT} = 3\text{A}$		14.5		m $\Omega$
		$V_{IN} = 4.5\text{V}$ ; $V_{EN} = 1.5\text{V}$ ; $I_{OUT} = 3\text{A}$		15.5		
		$V_{IN} = 3.6\text{V}$ ; $V_{EN} = 1.5\text{V}$ ; $I_{OUT} = 3\text{A}$		17.5		
		$V_{IN} = 2.7\text{V}$ ; $V_{EN} = 1.5\text{V}$ ; $I_{OUT} = 3\text{A}$		21		
		$V_{IN} = 1.8\text{V}$ ; $V_{EN} = 1.5\text{V}$ ; $I_{OUT} = 3\text{A}$		34		
		$V_{IN} = 1.7\text{V}$ ; $V_{EN} = 1.5\text{V}$ ; $I_{OUT} = 3\text{A}$		40		
Overvoltage Protection Threshold (MIC94161)	$V_{OVP}$	$V_{IN} = V_{EN}$ ; $I_{OUT} = 0$ ; $V_{IN}$ rising	<b>4.5</b>	4.75	<b>5</b>	V
Active Discharge Resistance (MIC94162/4)	$R_{AD}$	$V_{IN} = 3.6\text{V}$ ; $I_{TEST} = 1\text{mA}$ ; $V_{EN} = 0\text{V}$		200	<b>400</b>	$\Omega$

**Notes:**

- Exceeding the absolute maximum ratings may damage the device.
- The device is not guaranteed to function outside its operating ratings.
- With thermal contact to PCB (see [Application Information](#)).
- Devices are ESD sensitive. Handling precautions are recommended. Human body model, 1.5k $\Omega$  in series with 100pF.

## Electrical Characteristics (Continued)

$T_A = 25^\circ\text{C}$ , **bold** values indicate  $-40^\circ\text{C} \leq T_J \leq +125^\circ\text{C}$ , unless noted.

Parameter	Symbol	Condition	Min.	Typ.	Max.	Units
<b>Timing Characteristics</b>						
Turn-On Delay Time (MIC94162/3)	$t_{\text{ON}}$	$V_{\text{IN}} = 3.6\text{V}$ ; $R_{\text{LOAD}} = 1.2\Omega$ ; $C_{\text{OUT}} = 200\mu\text{F}$ ; $V_{\text{EN}} = 1.5\text{V}$		10		$\mu\text{s}$
Turn-On Rise Time (MIC94162/3)	$t_r$	$V_{\text{IN}} = 3.6\text{V}$ ; $R_{\text{LOAD}} = 1.2\Omega$ ; $C_{\text{OUT}} = 200\mu\text{F}$ ; $V_{\text{EN}} = 1.5\text{V}$		60		$\mu\text{s}$
Turn-On Delay Time (MIC94161/4/5)	$t_{\text{ON}}$	$V_{\text{IN}} = 3.6\text{V}$ ; $R_{\text{LOAD}} = 1.2\Omega$ ; $C_{\text{OUT}} = 200\mu\text{F}$ ; $V_{\text{EN}} = 1.5\text{V}$		0.4		ms
Turn-On Rise Time (MIC94161/4/5)	$t_r$	$V_{\text{IN}} = 3.6\text{V}$ ; $R_{\text{LOAD}} = 1.2\Omega$ ; $C_{\text{OUT}} = 200\mu\text{F}$ ; $V_{\text{EN}} = 1.5\text{V}$		2.7		ms
Turn-Off Delay Time	$t_{\text{OFF}}$	$V_{\text{IN}} = 3.6\text{V}$ ; $R_{\text{LOAD}} = 1.2\Omega$ ; $C_{\text{OUT}} = 200\mu\text{F}$ ; $V_{\text{EN}} = 1.5\text{V}$		25		$\mu\text{s}$
Turn-Off Fall Time	$t_f$	$V_{\text{IN}} = 3.6\text{V}$ ; $R_{\text{LOAD}} = 1.2\Omega$ ; $C_{\text{OUT}} = 200\mu\text{F}$ ; $V_{\text{EN}} = 1.5\text{V}$		500		$\mu\text{s}$

## Timing Diagrams

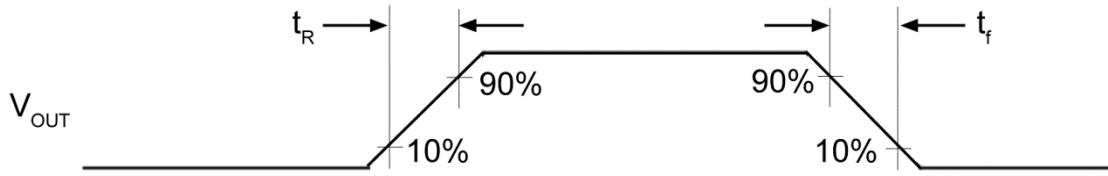

Figure 1. Output Voltage Rise and Fall time Measurements

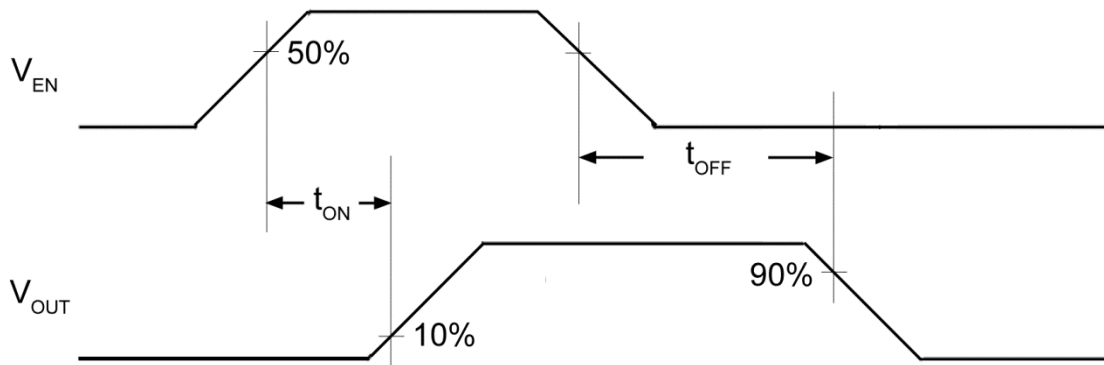
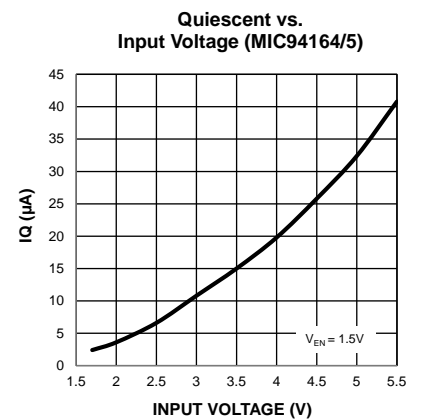
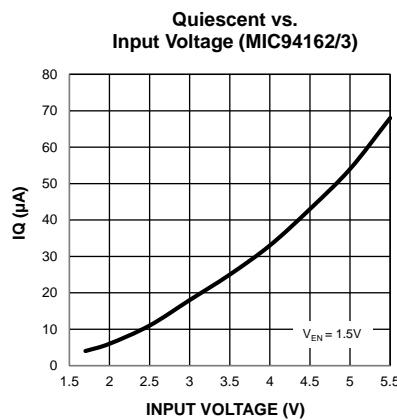
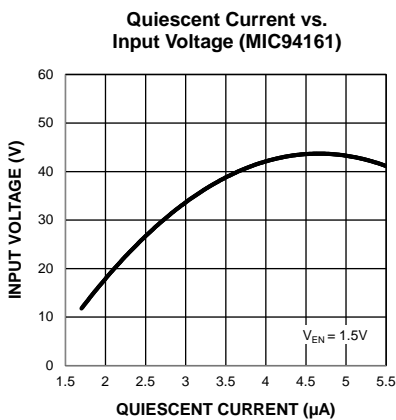
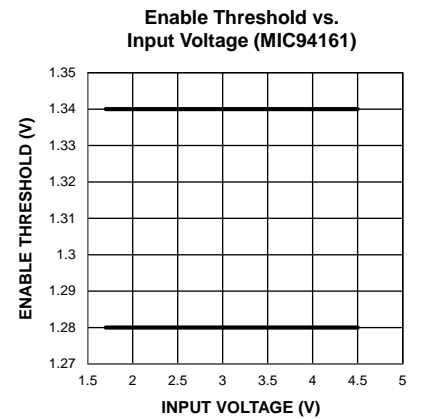
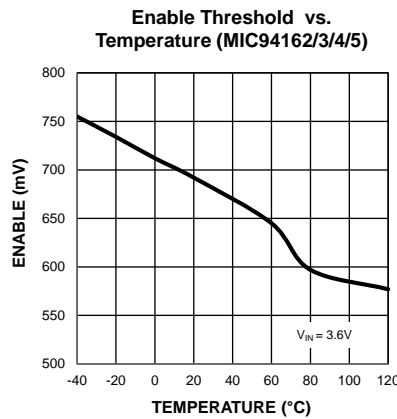
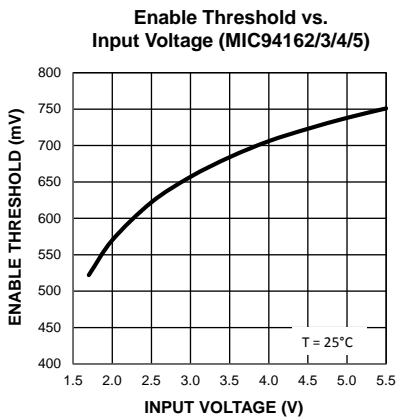
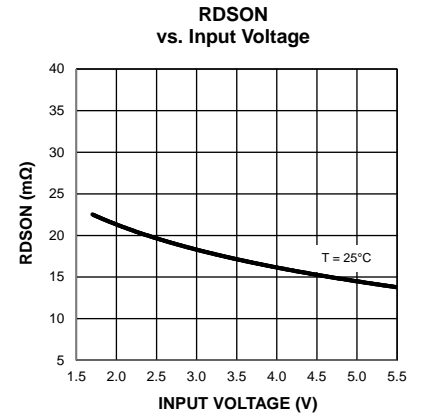
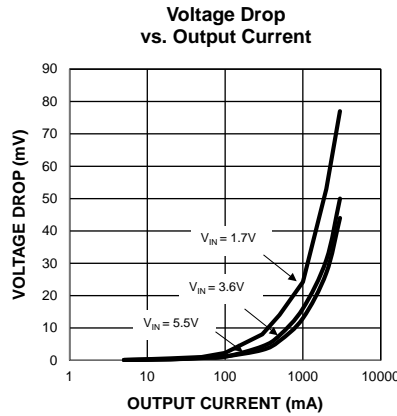
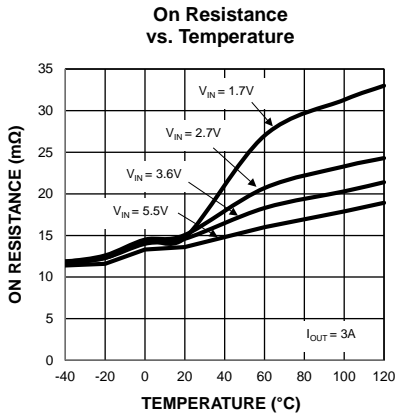

Figure 2. Output Voltage Turn On and Turn Off Measurements

# Typical Characteristics



## Typical Characteristics (Continued)

Quiescent Current vs. Temperature (MIC94161)

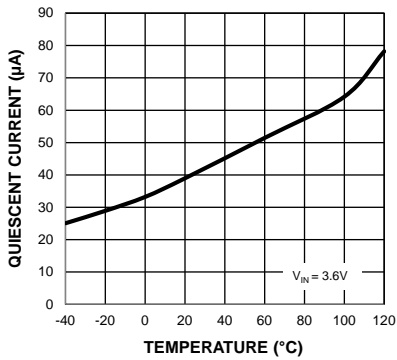

Quiescent Current vs. Temperature (MIC94162/3)

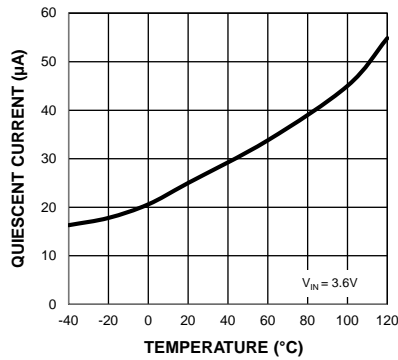

Quiescent Current vs. Temperature (MIC94164/5)

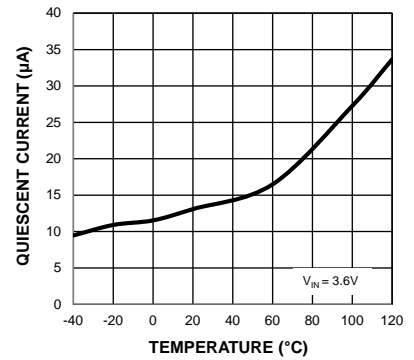

OVP Threshold vs. Temperature (MIC94161)

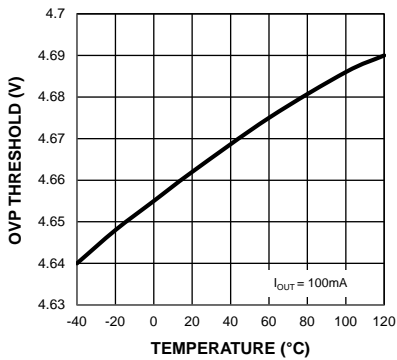

TON Delay vs. Input Voltage (MIC94162/3)

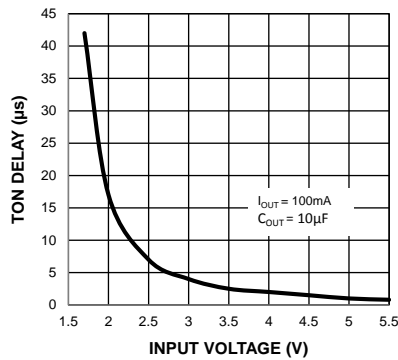

Rise Time vs. Input Voltage (MIC94162/3)

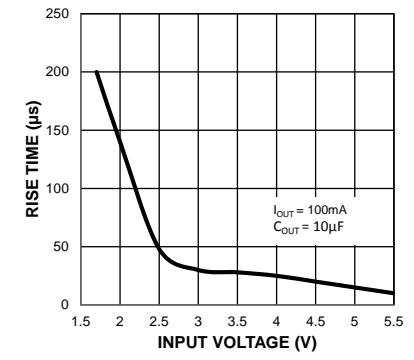

TON Delay vs. Input Voltage (MIC94161/4/5)

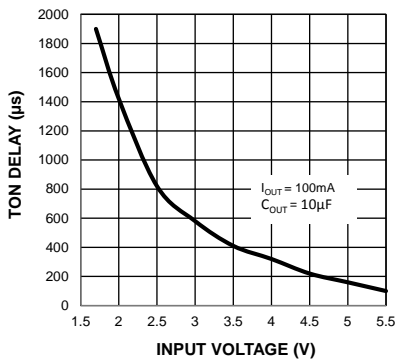

## Functional Characteristics

**MIC94162/3 Start-Up ( $I_{OUT} = 1A$ )**

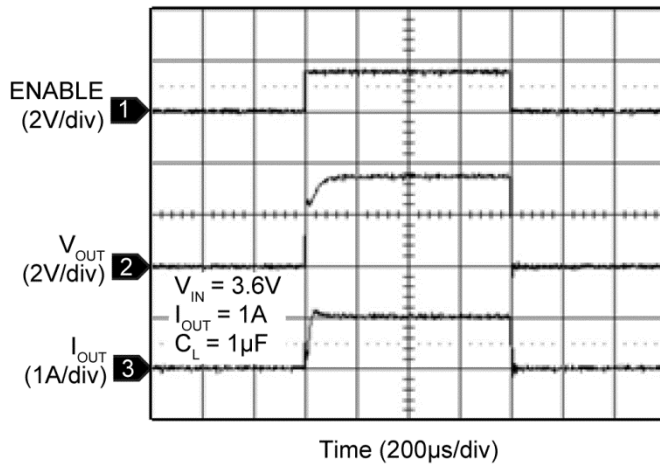

**MIC94162/3 Start-Up ( $I_{OUT} = 3A$ )**

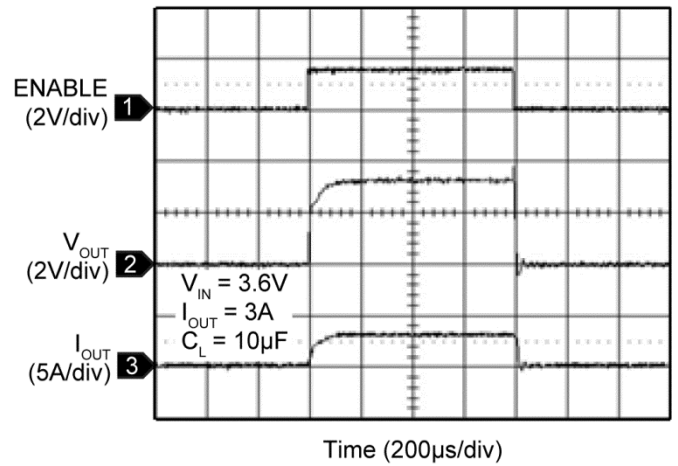

**MIC94161/4/5 Start-Up ( $I_{OUT} = 1A$ )**

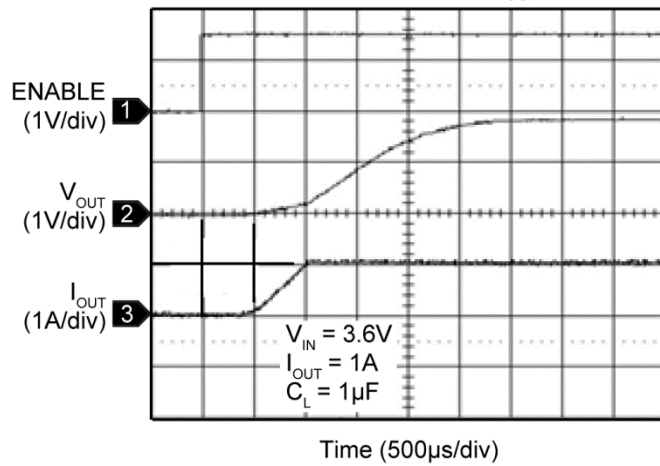

**MIC94161/4/5 Start-Up ( $I_{OUT} = 3A$ )**

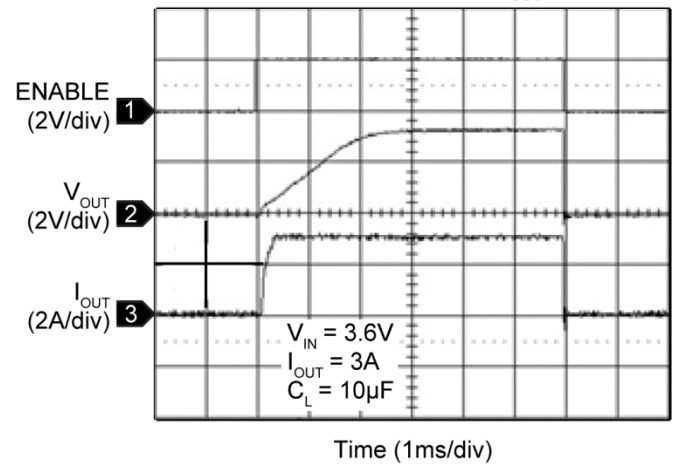

**MIC94164 Auto Discharge**

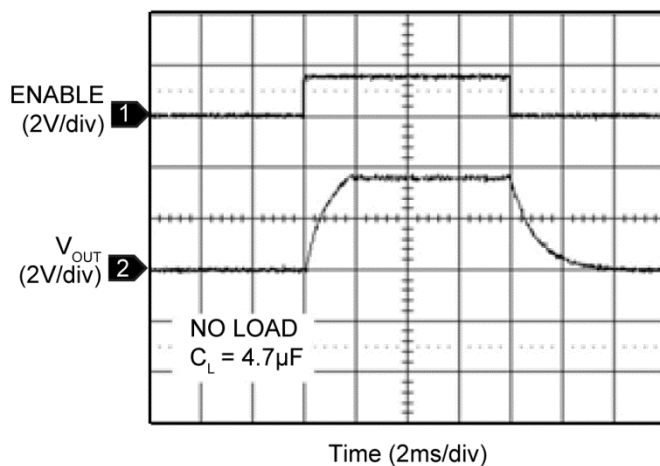



## Application Information

The MIC94161/2/3/4/5 is a family of high-side load switches designed to operate from 1.7V to 5.5V input voltage. The load switch pass element is an internal 14.5mΩ R<sub>DS(ON)</sub> N-Channel MOSFET which enables the device to support up to 3A of continuous current. Additionally, the load switch supports 1.5V logic level control and shutdown features in a tiny 1.5mm x 1mm 6-ball WLCSP package.

The MIC9416x provides reverse current protection when the device is disabled. The device will not allow the flow of current from the output to the input when the device is turned OFF. Additionally, the MIC94161 features overvoltage protection to protect the load when the input voltage is above 4.55V, as well as a precise enable threshold which keeps the MIC94161 in the default OFF state until the EN pin rises above 1.15V.

The MIC94162/3 features rapid turn on for applications that require quick startup time. The MIC94161/4/5 provides a slew rate controlled soft-start turn-on of 2.7ms. The soft-start feature is provided to prevent an in-rush current event from pulling down the input supply voltage.

The MIC94162/4 feature an active load discharge circuit which switches in a 200Ω load when the switch is disabled to automatically discharge a capacitive load.

An active pull-down on the enable input keeps the MIC94161/2/3/4/5 in a default OFF state until the enable pin is pulled above 1.2V. Internal level shift circuitry allows low voltage logic signals to switch higher supply voltages. The enable voltage can be as high as 5.5V and is not limited by the input voltage.

### Power Switch SOA

The safe operating area (SOA) curve represents the boundary of maximum safe operating current and maximum safe operating junction temperature.

Figure 3 illustrates the SOA for various input voltages, with the package mounted on a typical 1 layer, 1 square inch copper board.

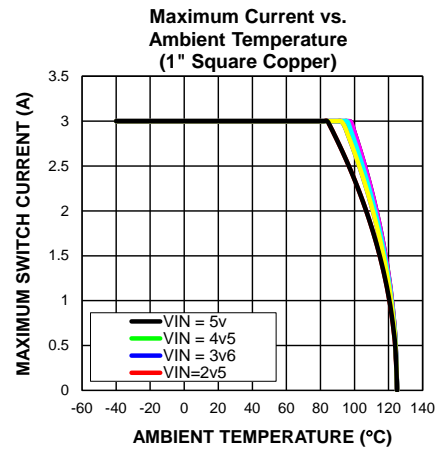

Figure 3. Safe Operating Area (SOA) Graph

### Power Dissipation Considerations

As with all power switches, the current rating of the switch is limited mostly by the thermal properties of the package and the PCB it is mounted on. There is a simple ohms law type relationship between thermal resistance, power dissipation and temperature, which are analogous to an electrical circuit:

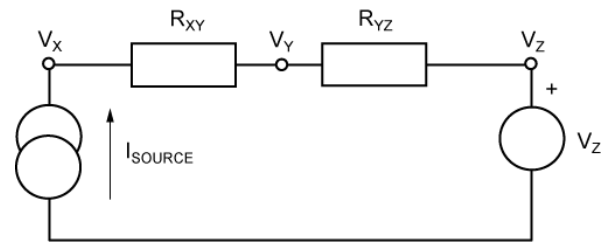

Figure 4. Simple Electrical Circuit

From this simple circuit we can calculate V<sub>x</sub> if we know I<sub>SOURCE</sub>, V<sub>Z</sub> and the resistor values, R<sub>XY</sub> and R<sub>YZ</sub> using Equation 1:

$$V_x = I_{SOURCE} (R_{XY} + R_{YZ}) + V_Z \tag{Eq. 1}$$

Thermal circuits can be considered using these same rules and can be drawn similarly by replacing current sources with power dissipation (in watts), resistance with thermal resistance (in °C/W) and voltage sources with temperature (in °C).

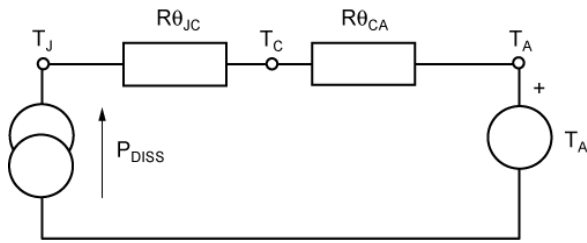

Figure 5. Simple Thermal Circuit

Now replacing the variables in the equation for  $V_x$ , one can find the junction temperature ( $T_J$ ) from power dissipation, ambient temperature and the known thermal resistance of the PCB ( $R_{\theta_{CA}}$ ) and the package ( $R_{\theta_{JC}}$ ).

$P_{DISS}$  is calculated as  $I_{SW}^2 \times R_{SW(MAX)}$ .  $R_{\theta_{JC}}$  is found in the operating ratings section of the datasheet and  $R_{\theta_{CA}}$  (the PCB thermal resistance) values for various PCB copper areas is discussed in the document [Designing with Low Dropout Voltage Regulators](#) available from the [Micrel website](#).

**Example:**

A switch is intended to drive a 3A load and is placed on a printed circuit board which has a ground plane area of at least 25mm x 25mm (625mm<sup>2</sup>). The voltage source is a Li-ion battery with a lower operating threshold of 3V and the ambient temperature of the assembly can be up to 80°C.

Summary of variables:

- $I_{SW} = 3A$
- $V_{IN} = 3V$  to 4.2V
- $T_A = 80^\circ C$
- $R_{\theta_{JA}} = 108^\circ C/W$
- $P_{DISS} = I_{SW}^2 \times R_{SW}$

The worst case switch resistance ( $R_{SW}$ ) at the lowest  $V_{IN}$  of 3V is not available in the datasheet, so the next lower value of  $V_{IN}$  is used, as shown in Equation 2

$$R_{SW} @ 2.7V = 21m\Omega \quad \text{Eq. 2}$$

If this were a figure for worst case  $R_{SW}$  for 25°C, an additional consideration is to allow for the maximum

junction temperature of 125°C, in this case can be 30% higher (see the “On Resistance vs. Temperature” graph in the [Typical Characteristics](#) section):

$$R_{SW(MAX)} = 27m\Omega \quad \text{Eq. 3}$$

Therefore:

$$T_{RISE} = (3A^2 \times 27m\Omega) \times 108^\circ C/W = 26.2^\circ C$$

$$T_J = T_{RISE} + T_A = 26.2^\circ C + 80^\circ C = 106.2^\circ C$$

This is below the maximum 125°C.

**Package Information<sup>(5)</sup> and Recommended Landing Pattern**

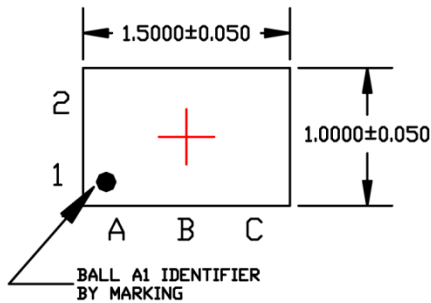

TOP VIEW  
NOTE: 1, 2

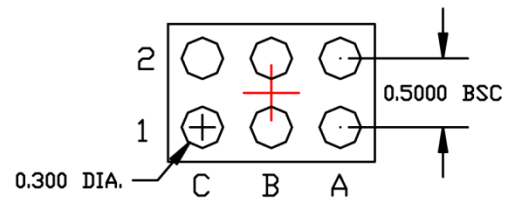

BOTTOM VIEW  
NOTE: 1, 2

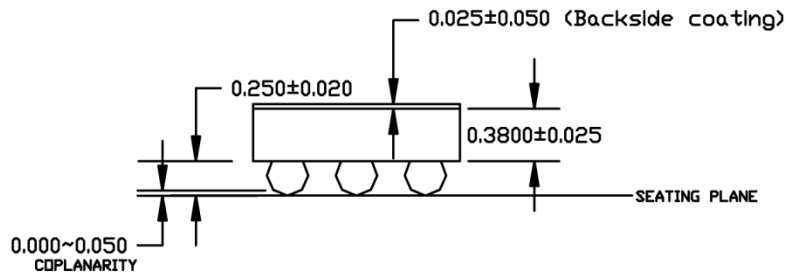

SIDE VIEW  
NOTE: 1, 2

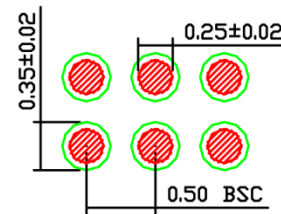

RECOMMENDED LAND PATTERN  
NOTE: 3, 4

**NOTE:**

1. MAX PACKAGE WARPAGE IS 0.05 MM
2. MAX ALLOWABLE BURR IS 0.076MM IN ALL DIRECTIONS
3. NON-SOLDERMASK DEFINED PADS ARE RECOMMENDED FOR BOARD LAYOUT
4. SHADED RED CIRCLES REPRESENT CONTACT PAD AREA. GREEN CIRCLES REPRESENT SOLDER MASK OPENING

**1.5mm x 1mm 6-Ball WLCSP**

**Note:**

5. Package information is correct as of the publication date. For updates and most current information, go to [www.micrel.com](http://www.micrel.com).

---

**MICREL, INC. 2180 FORTUNE DRIVE SAN JOSE, CA 95131 USA**  
TEL +1 (408) 944-0800 FAX +1 (408) 474-1000 WEB <http://www.micrel.com>

Micrel makes no representations or warranties with respect to the accuracy or completeness of the information furnished in this data sheet. This information is not intended as a warranty and Micrel does not assume responsibility for its use. Micrel reserves the right to change circuitry, specifications and descriptions at any time without notice. No license, whether express, implied, arising by estoppel or otherwise, to any intellectual property rights is granted by this document. Except as provided in Micrel's terms and conditions of sale for such products, Micrel assumes no liability whatsoever, and Micrel disclaims any express or implied warranty relating to the sale and/or use of Micrel products including liability or warranties relating to fitness for a particular purpose, merchantability, or infringement of any patent, copyright or other intellectual property right.

Micrel Products are not designed or authorized for use as components in life support appliances, devices or systems where malfunction of a product can reasonably be expected to result in personal injury. Life support devices or systems are devices or systems that (a) are intended for surgical implant into the body or (b) support or sustain life, and whose failure to perform can be reasonably expected to result in a significant injury to the user. A Purchaser's use or sale of Micrel Products for use in life support appliances, devices or systems is a Purchaser's own risk and Purchaser agrees to fully indemnify Micrel for any damages resulting from such use or sale.

© 2013 Micrel, Incorporated.