

Over voltage and over current protection IC

Descriptions

The WS3202K is an Over-Voltage-Protection (OVP) and Over-Current-Protection (OCP) device. The device will switch off internal MOSFET to disconnect IN to OUT to protect load when any of input voltage, input current over the threshold. The Over temperature protection (OTP) function monitors chip temperature to protect the device.

The WS3202K is available in SOT-89-3L package. Standard products are Pb-free and Halogen-free.

Features

- High voltage technology
- Maximum input voltage : 30V
- Maximum output current : 2A
- Output power ON time : 8ms (Typ.)
- OVP threshold : 6.1V (Typ.)
- OVP response time : <1us
- OCP threshold : 2A (Min.)
- Output discharge
- Package : SOT-89-3L

Applications

- GPS
- PMP
- MID
- PAD
- Digital cameras
- Digital Videos



SOT-89-3L

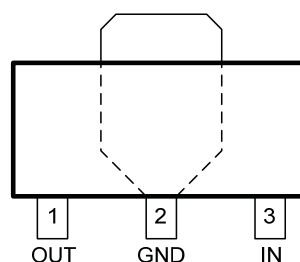

Pin configuration (Top view)

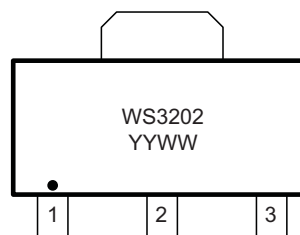

WS3202 = Device code
YY = Year
WW = Week
Marking

Order information

Device	Package	Shipping
WS3202K-3/TR	SOT-89-3L	1000/Reel&Tape

Typical applications

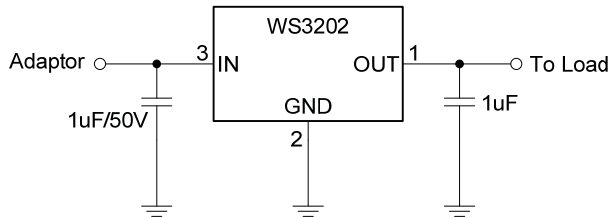

Pin descriptions

Pin No.	Symbol	Descriptions
1	OUT	Output pin, connect to load
2	GND	Power ground
3	IN	Input pin, connect to AC adaptor or VBUS. A 1uF low ESR ceramic capacitor or larger must be connected as close as to this pin. It is recommended to use 50V capacitor or according to application.

Block diagram

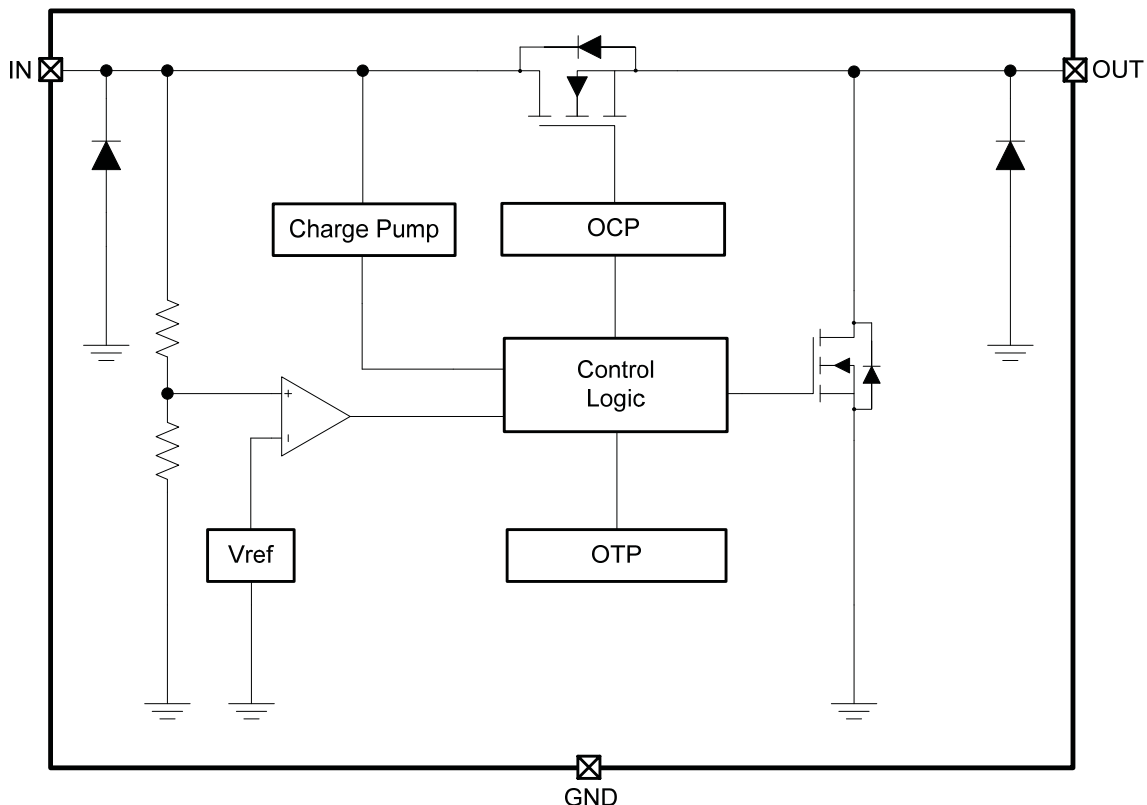

Absolute maximum ratings

Parameter	Symbol	Value	Unit
Input voltage (IN pin)	V_{IN}	-0.3 ~ 30	V
Output voltage (OUT pin)	V_{OUT}	-0.3 ~ 6.5	V
Output current	I_{OUT}	2.0	A
Power dissipation *1 *3	P_D	1.0	W
Power dissipation *2 *3		0.5	W
Thermal resistance *1	$R_{\theta JA}$	125	°C/W
Thermal resistance *2		250	°C/W
Junction temperature	T_J	150	°C
Lead temperature(10s)	T_L	260	°C
Storage temperature	T_{stg}	-55 ~ 150	°C
ESD Ratings	HBM	±8	KV
	MM	±1	KV

Note: These are stress ratings only. Stresses exceeding the range specified under “Absolute Maximum Ratings” may cause substantial damage to the device. Functional operation of this device at other conditions beyond those listed in the specification is not implied and prolonged exposure to extreme conditions may affect device reliability.

*1: Surface mounted on FR-4 Board using 1 square inch pad size, dual side, 1oz copper

*2: Surface mounted on FR-4 board using minimum pad size, 1oz copper

*3: Power dissipation is calculated by $P_D = (V_{IN} - V_{OUT}) \times I_{OUT}$

Recommend operating conditions (Ta=25°C, unless otherwise noted)

Parameter	Symbol	Value	Unit
Input voltage	V_{IN}	3 ~ 26	V
Output current	I_{OUT}	1.5	A
Ambient operating temperature	T_{opr}	-40 ~ 85	°C

Electronics Characteristics (Ta=25°C, unless otherwise noted)

Parameter	Symbol	Test conditions	Min.	Typ.	Max.	Unit
DC characteristics and Power-ON-Reset						
Input quiescent current	I _Q	V _{IN} =5V, I _{OUT} =0A		280	350	μA
IN-to-OUT ON resistance *3	R _{ON}	V _{IN} =5V, I _{OUT} =0.7A		190	220	mΩ
Output discharge resistance	R _{DISCHARGE}			500		Ω
Under voltage lock out threshold	UVLO	V _{IN} increasing from 0~3V	2.3		2.8	V
Under voltage lock out hysteresis	V _{HYS-UVLO}	V _{IN} decreasing from 3~0V	200	250	300	mV
Output power-on time	T _{ON}	V _{IN} = 0 -> 5V to output ON	6	8	10	ms
Input Over-Voltage-Protection (OVP)						
OVP threshold	V _{OVP}	V _{IN} increasing from 5~7V	5.8	6.1	6.4	V
OVP hysteresis	V _{HYS-OVP}	V _{IN} decreasing from 7~5V	200	300	400	mV
OVP active time	T _{OVP}	V _{IN} = 5 -> 10V			1	us
OVP recovery time	T _{ON(OVP)}	V _{IN} = 10 -> 5V to output ON	6	8	10	ms
Input Over-Current-Protection (OCP)						
OCP threshold	I _{OCP}		2.0	2.5	3.3	A
OCP active time	T _{OCP}			176		us
OCP recovery time	T _{ON(OCP)}			1		s
Over-Temperature-Protection (OTP)						
OTP threshold				165		°C
OTP hysteresis				40		°C

*3: Single Pulse, Pulse width=10ms

Typical Characteristics (Ta=25°C, unless otherwise noted)

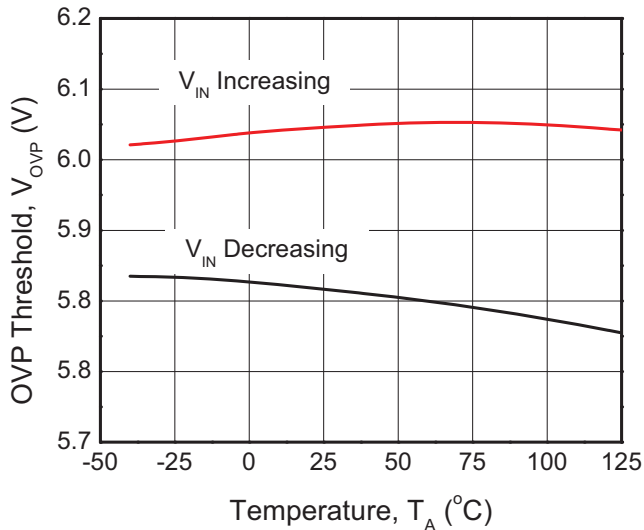

OVP threshold vs. Temperature

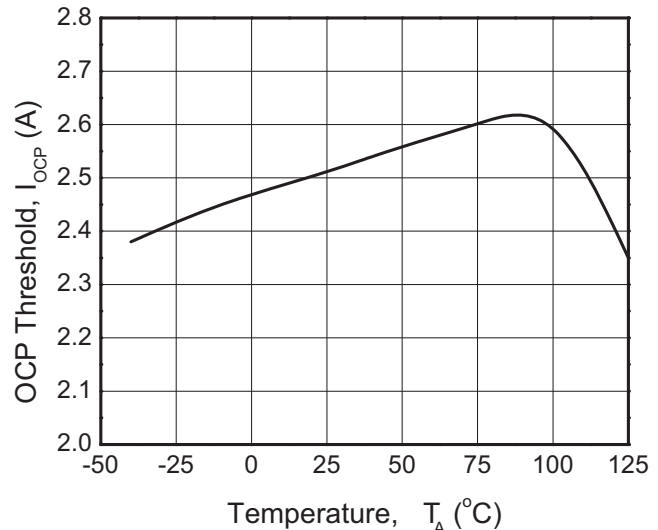

OCP threshold vs. Temperature

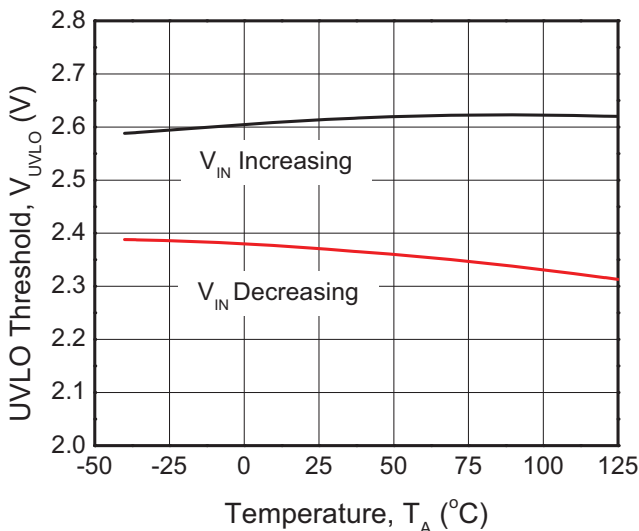

UVLO threshold vs. Temperature

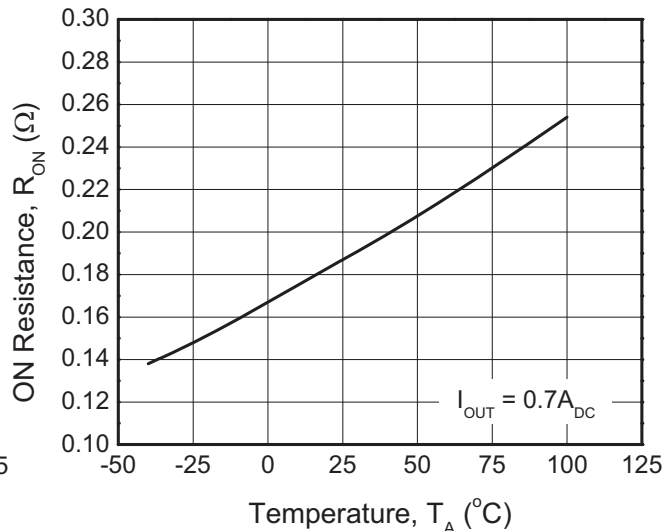

IN-to-OUT ON resistance vs. Temperature

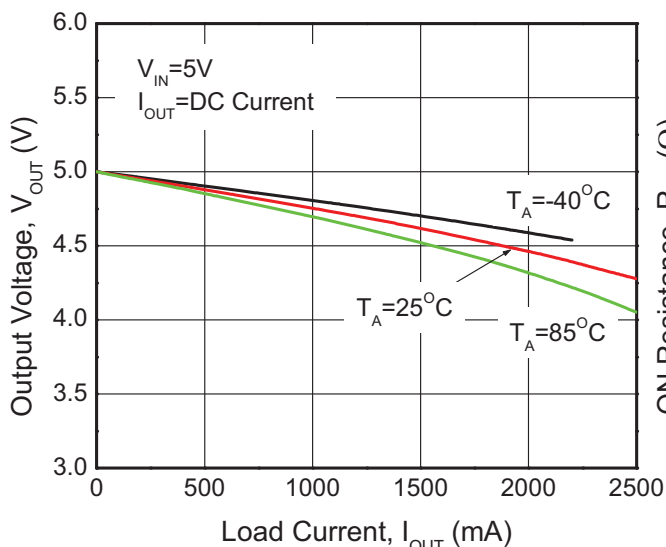

Output voltage vs. Output current

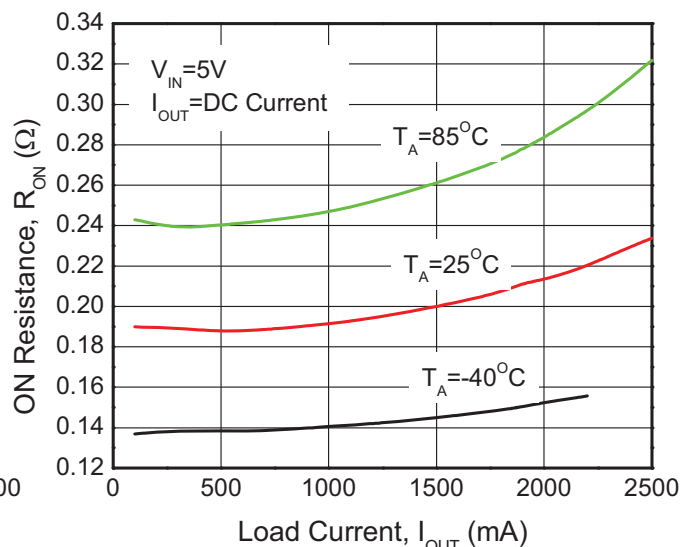

ON resistance vs. Output current

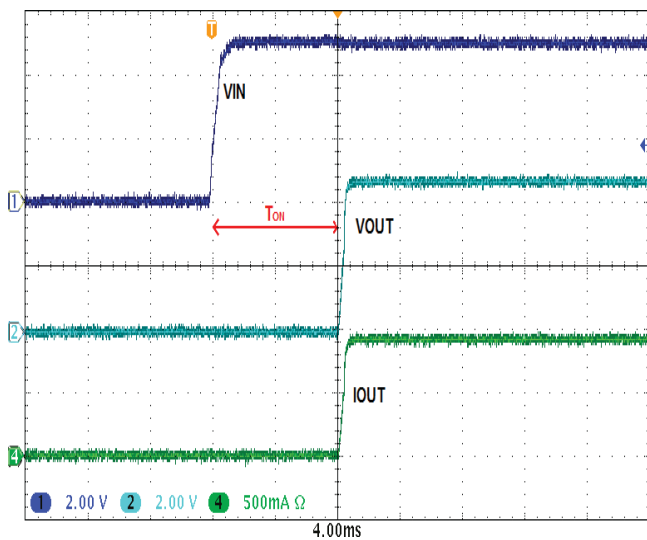

Normally Power ON

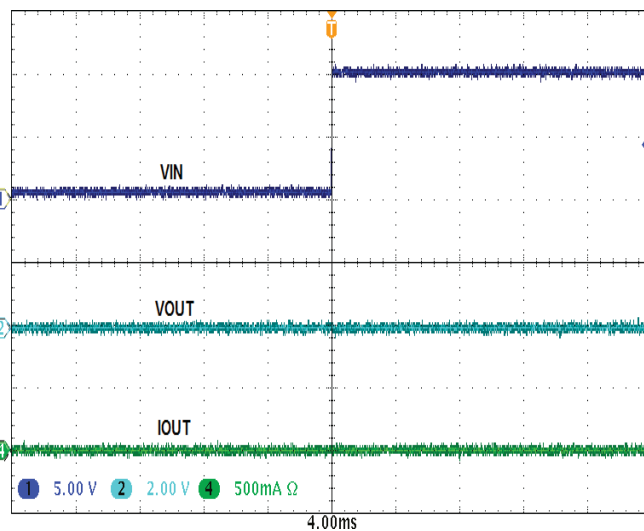

Power ON with Input Overtoltage

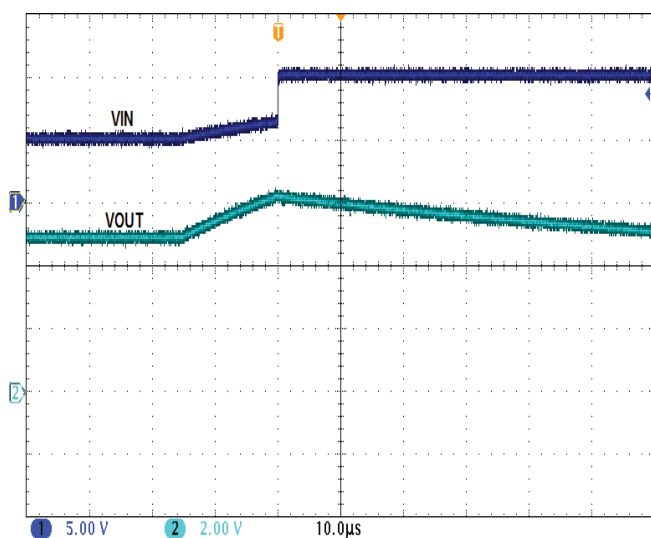

OVP Active Time

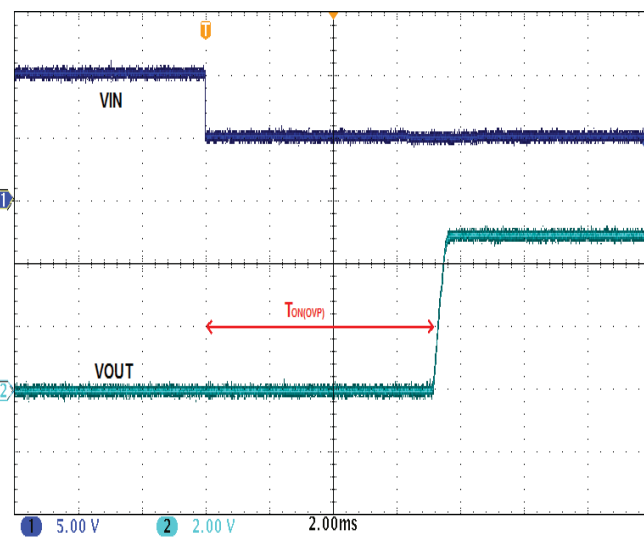

OVP Recovery Time

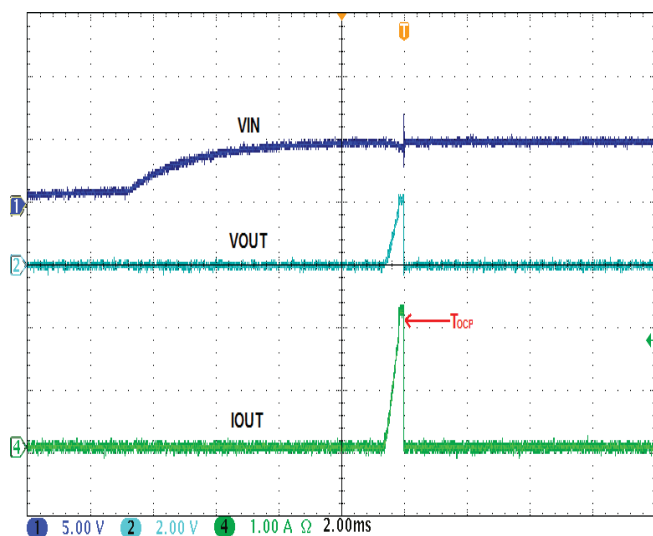

OCP Active Time

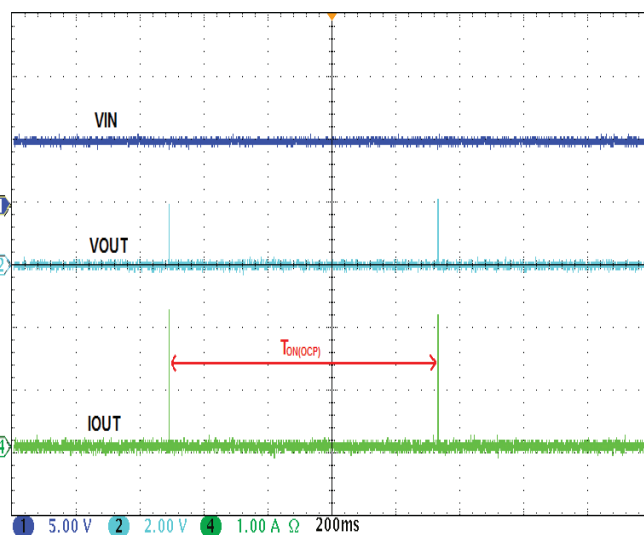

OCP Recovery Time

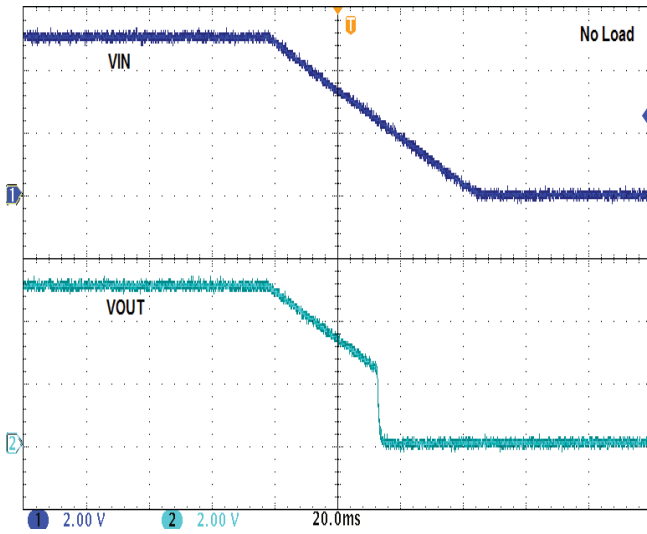

Normally Power OFF

Package outline dimensions

SOT-89-3L

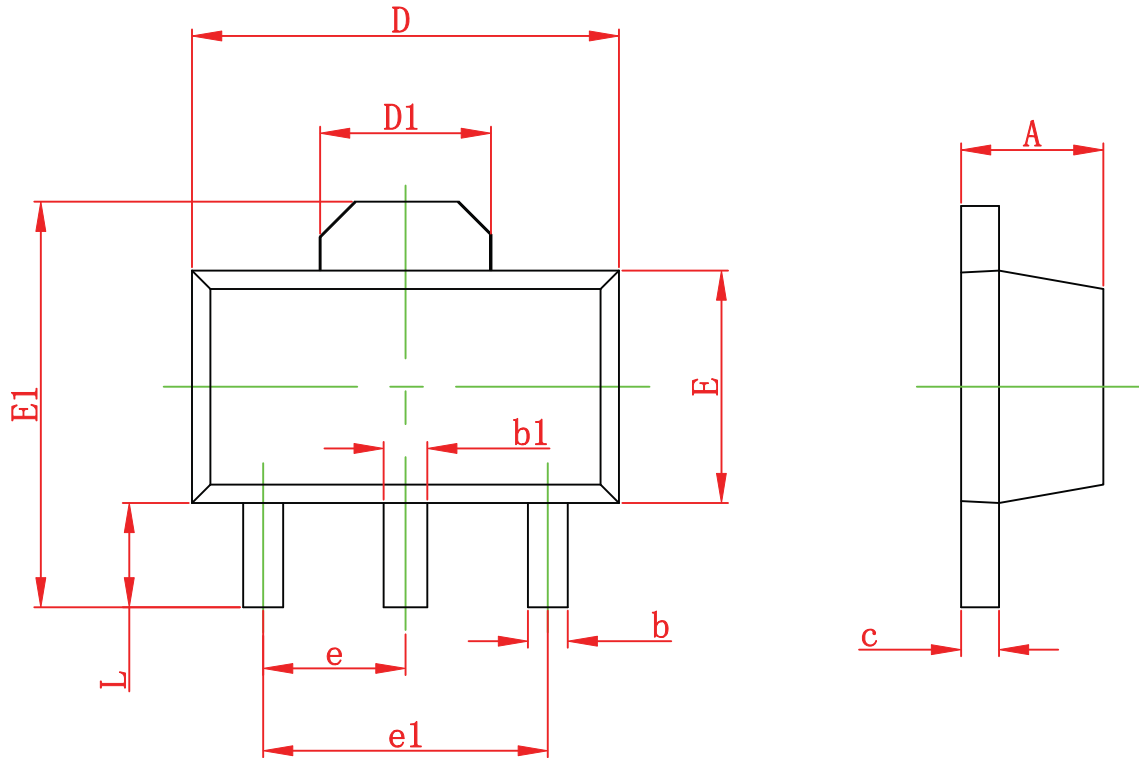

Symbol	Dimensions in millimeter		
	Min.	Typ.	Max.
A	1.400	1.500	1.600
b	0.320	0.420	0.520
b1	0.400	0.490	0.580
c	0.350	-	0.440
D	4.400	4.500	4.600
D1	1.550 Ref.		
E	2.300	2.450	2.600
E1	3.940	4.100	4.250
e	1.500 Typ.		
e1	3.000 Typ.		
L	0.900	-	1.200