

Using the C30 Compiler to Interface SPI Serial EEPROMs with dsPIC33F and PIC24F

*Author: Martin Kvasnicka
Microchip Technology Inc.*

INTRODUCTION

The 25XXX series serial EEPROMs from Microchip Technology are SPI compatible and have maximum clock frequencies ranging from 3 MHz to 20 MHz. Many times when designing an application which utilizes a serial EEPROM device, it may be beneficial to use a microcontroller which does not feature a dedicated protocol-specific serial port. This can be due to several possible reasons, including size restrictions or costs. In these instances, it is required of the designer to write software routines capable of generating the proper signals for communicating with the EEPROM device.

This application note provides assistance and source code to ease the design process of interfacing a Microchip dsPIC33F Digital Signal Controller to a Microchip SPI serial EEPROM, without the use of a hardware serial port.

Figure 1 describes the hardware schematic for the interface between Microchip's 25XXX series devices and the dsPIC33F DSC or PIC24F PIC[®] microcontroller. The schematic shows the connections necessary between the DSC or PIC MCU and the serial EEPROM as tested, and the software was written assuming these connections. The \overline{WP} and \overline{HOLD} pins are tied to Vcc through resistors, because the write-protect and hold features are not used in the examples provided.

FIGURE 1: CIRCUIT FOR dsPIC33F256GP710, PIC24FJ128GA010 AND 25XXX SERIES DEVICES

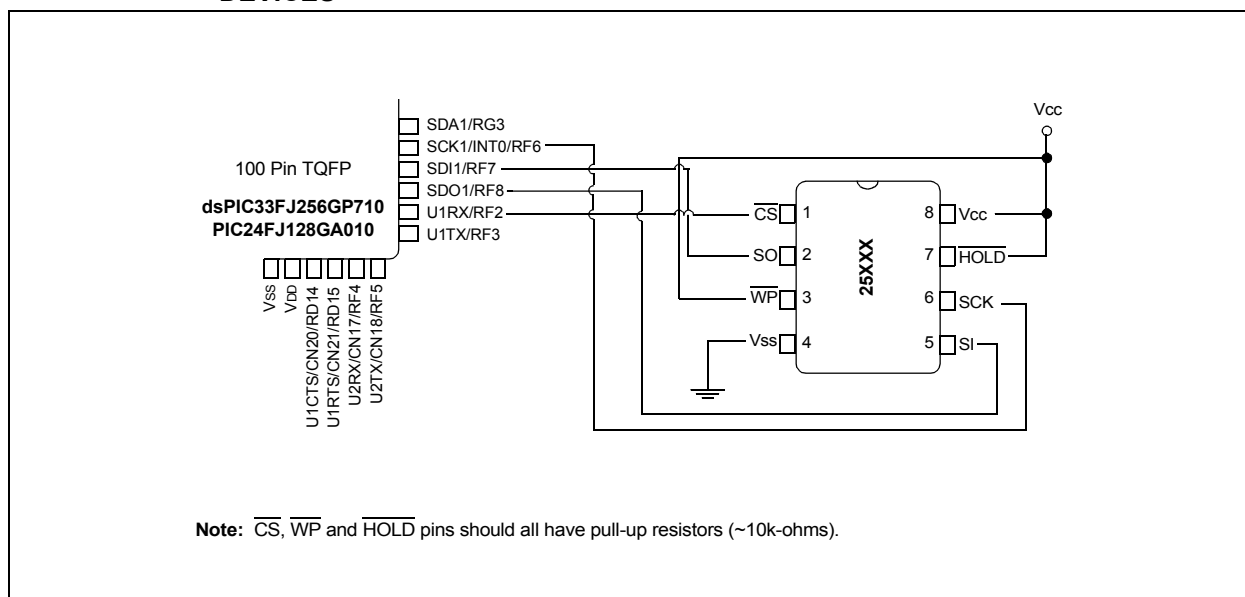

FIRMWARE DESCRIPTION

The purpose of the program is to show individual features of the SPI protocol and give code samples of the instructions and addressing schemes so that the basic building blocks of a program can be shown. The firmware performs the following operations:

- Low-Density Byte Write
- Low-Density Byte Read
- Low-Density Page Write
- Low-Density Sequential Read
- Write Enable
- WIP Polling

In addition, the following operations are available but not explicitly illustrated:

- High-Density Byte Write
- High-Density Byte Read
- High-Density Page Write
- High-Density Sequential Read
- Write Disable
- Read Status Register
- Write Status Register

The low-density routines are intended for use with the 4K and smaller density devices that use only one byte for addressing. The high-density routines are intended for use with 8K and higher density devices that use two bytes for addressing. This program also exhibits the WIP polling feature for detecting the completion of write cycles after the byte write and page write operations. Read operations are located directly after each write operation, thus allowing for verification that the data was properly written. No method of displaying the input data is provided, but a SEEVAL[®] 32 evaluation system, an oscilloscope, or a Microchip MPLAB[®] ICD 2 could be used.

The low-density code was tested using the 25LC040A serial EEPROM. This device features 512 x 8 (4 Kbit) of memory and 16-byte pages. The high-density code was tested using the 25LC256 serial EEPROM. This device features 32K x 8 (256 Kbit) of memory and 64-byte pages. Only the low-density operations are illustrated in this application note.

Oscilloscope screen shots are labeled for ease in reading. The data sheet versions of the waveforms are shown below the oscilloscope screen shots. All timings are designed to meet the data sheet specs, and an 8 MHz crystal oscillator is used to clock the dsPIC33F DSC or PIC24F microcontroller. If a different clock is used, the code may need to be modified to avoid violating timing specs. All values represented in this application note are decimal values unless otherwise noted.

WRITE ENABLE

Figure 2 shows an example of the Write Enable command. Chip Select is brought low (active) and the opcode (0x06) is shifted out. The Write Enable command must be given in order to set the WEL bit before

a write is attempted to either the array or the STATUS register. The WEL bit can be cleared by issuing a Write Disable command (WRDI) and is also automatically reset if the device is powered down or if a write cycle is completed.

FIGURE 2: WRITE ENABLE (WREN)

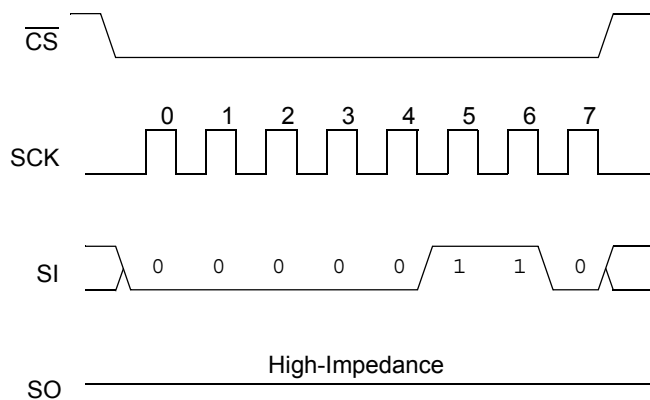

READ STATUS REGISTER TO CHECK FOR WEL BIT

Figure 3 shows an example of the Read Status Register command to check for the WEL bit. This bit must be set before a write is attempted to either the STATUS register or the array. It is good programming practice to check for the bit to be set before attempting the write. Once again the device is selected and the opcode (0x05) is sent.

The STATUS register is shifted out on the Serial Out pin. A value of 0x02 shows that the WEL bit in the STATUS register has been set. The device is now ready to do a write to either the STATUS register or the array.

FIGURE 3: READ STATUS REGISTER TO CHECK FOR WEL BIT (RDSR)

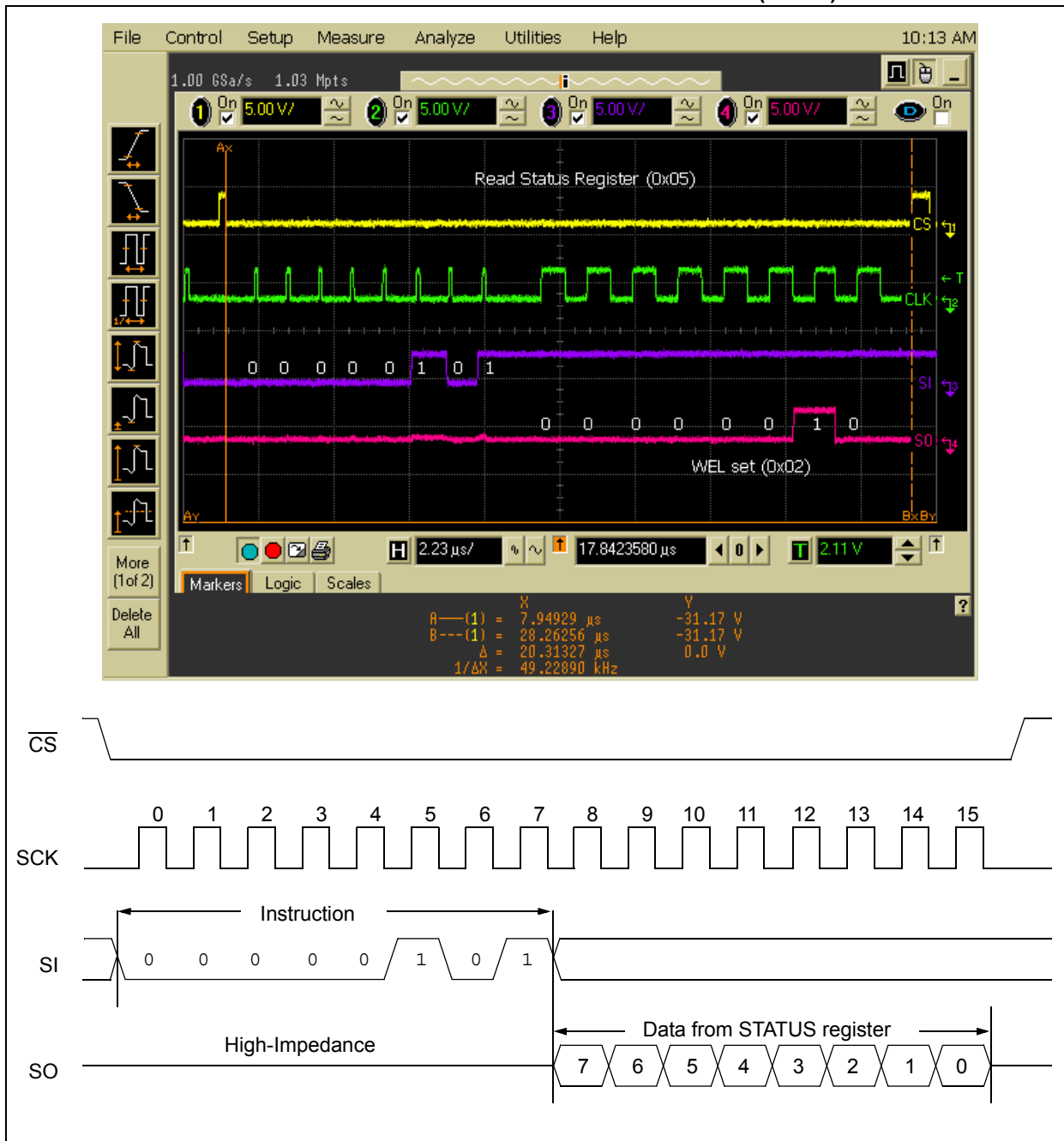

BYTE WRITE COMMAND (OPCODE, ADDRESS AND DATA)

Figure 4 shows an example of the Write command. First, the device is selected by bringing Chip Select low (active). In this example, the Most Significant bit of the address is a '1'. This bit is embedded in the opcode (0x02 for a Write command), and so the value, 0x0A, is sent. The Low Address byte (0x33) is sent next. Finally, the data is clocked in, in this case, 0xCC. Once Chip Select is toggled at the end of this command, the internal write cycle is initiated. After the write cycle has begun, the WIP bit in the STATUS register can be polled to check when the write finishes. If polling is not used, a delay (~5ms) needs to be added to ensure the write has finished. This code uses WIP polling.

A page write can be accomplished by continuing to send data bytes to the device without toggling \overline{CS} . Up to 16 bytes can be written to the 25LC040A before a write cycle is needed. Once \overline{CS} is brought high after the data bytes have been transmitted, then the write cycle timer will begin and normal polling can be initiated.

The Page Write function provided in the firmware is used to program 16 bytes of data, starting at address 0x150. Because page writes cannot cross page boundaries, care must be taken to avoid having data wrap around to the beginning of the page and overwrite existing data.

FIGURE 4: BYTE WRITE COMMAND, ADDRESS AND DATA

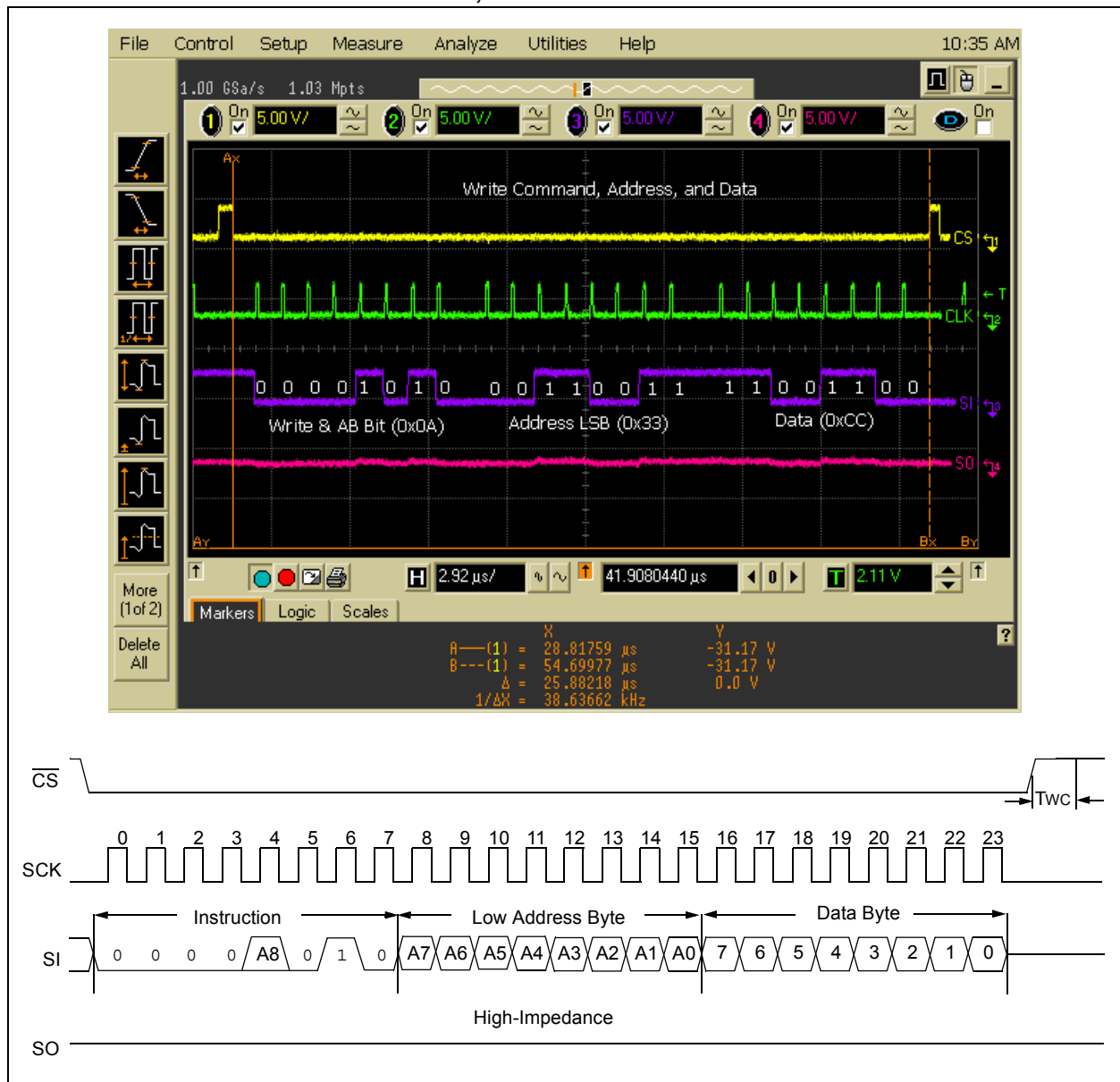

DATA POLLING (RDSR – CHECK FOR WIP SET)

After a valid Write command is given, the STATUS register can be read to check if the internal write cycle has been initiated, and it can continuously be monitored to look for the end of the write cycle. In this

case, the device is selected and the RDSR opcode (0x05) is sent. The STATUS register is then shifted out on the Serial Out (SO) pin resulting in a value of 0x03. Figure 5 shows that both the WEL bit (bit 1) and the WIP bit (bit 0) are set, meaning that the write cycle is in progress.

FIGURE 5: DATA POLLING (READ STATUS REGISTER TO CHECK WIP BIT)

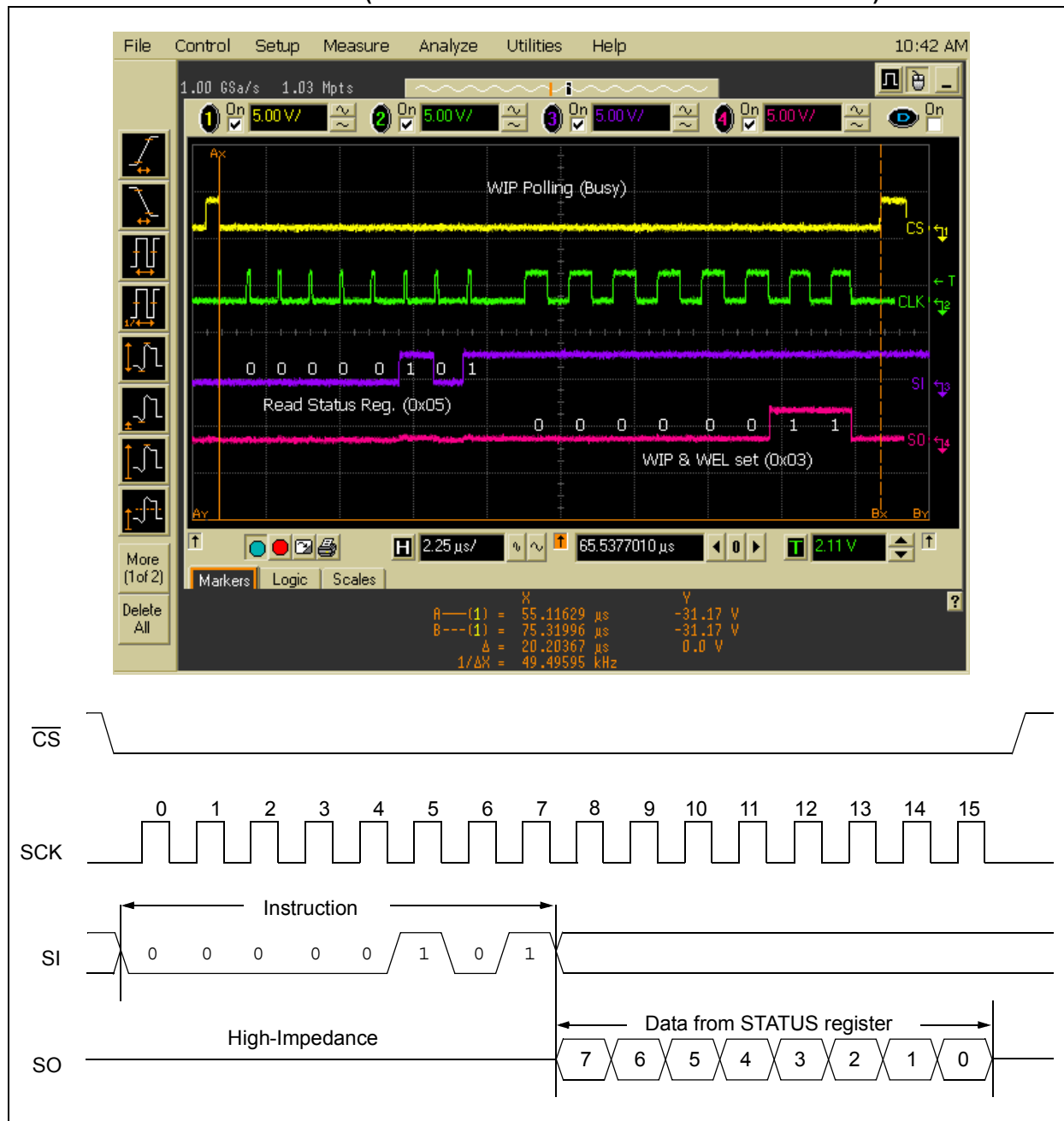

DATA POLLING FINISHED (RDSR – WIP BIT CLEARED)

The firmware remains in a continuous loop and the WIP status is evaluated until the bit is cleared. Figure 6 shows the Read Status Register command followed by a value of 0x00 being shifted out on the Serial Out (SO) pin. This indicates that the write cycle has finished and the device is now ready for additional commands. The WEL bit is also cleared at the end of a write cycle, which serves as additional protection against unwanted writes.

FIGURE 6: DATA POLLING FINISHED (RDSR – WIP AND WEL BITS CLEARED)

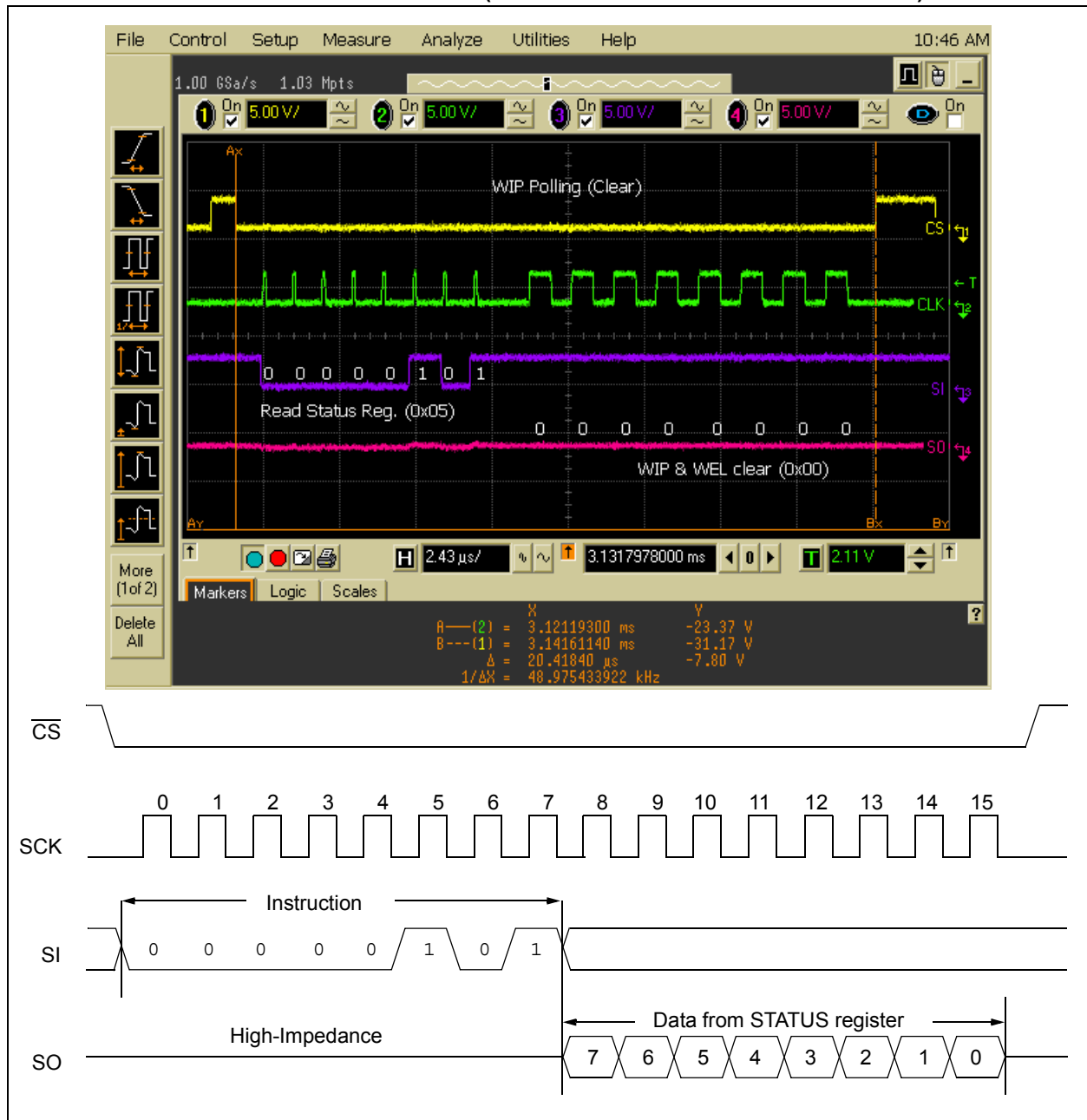

AN1096

READ COMMAND (OPCODE, ADDRESS AND DATA)

Figure 7 shows an example of the Read command. For this, the device is selected. As with the Write command, the Most Significant bit of the address is a '1'. Therefore, when combined with the Read opcode (0x03), the value 0x0B is sent. The Low Address byte, 0x33, is

then sent. Finally the data, 0xCC in this case, is clocked out on the Serial Out (SO) pin. In order to perform a sequential read, more clocks need to be generated. It is possible to read the entire chip by continuing to clock the device. Once the end of the array is reached, the data will wrap to the beginning of the array (address 0x000) and keep reading out until \overline{CS} is deselected or the device is no longer being clocked.

FIGURE 7: READ COMMAND, ADDRESS AND DATA

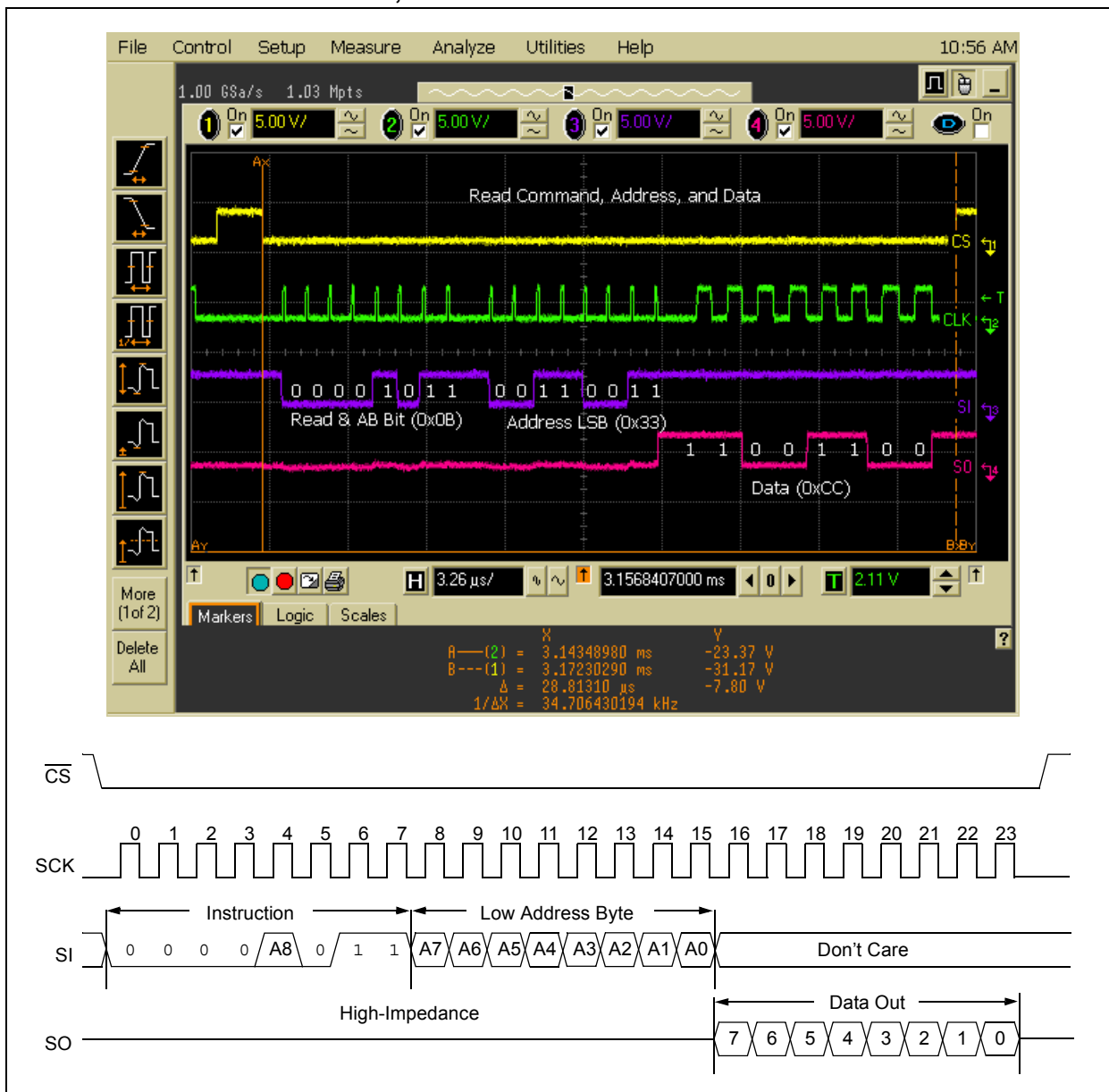

CHANGING PROCESSORS

This application note code was written to simplify changing between processors. There are, however, a couple of steps that need to be taken in order to do this. This application note was tested with two specific processors, the dsPIC33FJ256GP710 and the PIC24FJ128GA010. If you are going to use processors that are different from these two, please consult the device-specific data sheet to check for any other potential issues when using this code. As mentioned previously, the Explorer 16 development board was used for this application note with the connections shown in Figure 1. In order to change between these processors there are four steps:

1. The current processor module currently on the Explorer 16 board must be physically replaced with the processor module desired. Be sure to disconnect power during this procedure.
2. The #define statements on lines 42 and 43 in the an1096.h file must be commented in/out for the desired processor.
3. The new processor needs to be selected in the MPLAB IDE by going to Configure>Select Device...
4. The linker file needs to be added/removed for the desired processor. If this is not done, it will not prevent the code from compiling but may create some undesired warnings from the compiler.

CONCLUSION

These are some of the basic features of SPI communications on one of Microchip's dsPIC33F or PIC24F devices without the use of a hardware serial port. The code is highly portable and can be used on many dsPIC[®] DSCs with very minor modifications. Using the code provided, designers can begin to build their own SPI libraries to be as simple or as complex as needed. The code was tested on Microchip's Explorer 16 Demonstration Board with the connections shown in Figure 1.

AN1096

NOTES:

Note the following details of the code protection feature on Microchip devices:

- Microchip products meet the specification contained in their particular Microchip Data Sheet.
- Microchip believes that its family of products is one of the most secure families of its kind on the market today, when used in the intended manner and under normal conditions.
- There are dishonest and possibly illegal methods used to breach the code protection feature. All of these methods, to our knowledge, require using the Microchip products in a manner outside the operating specifications contained in Microchip's Data Sheets. Most likely, the person doing so is engaged in theft of intellectual property.
- Microchip is willing to work with the customer who is concerned about the integrity of their code.
- Neither Microchip nor any other semiconductor manufacturer can guarantee the security of their code. Code protection does not mean that we are guaranteeing the product as "unbreakable."

Code protection is constantly evolving. We at Microchip are committed to continuously improving the code protection features of our products. Attempts to break Microchip's code protection feature may be a violation of the Digital Millennium Copyright Act. If such acts allow unauthorized access to your software or other copyrighted work, you may have a right to sue for relief under that Act.

Information contained in this publication regarding device applications and the like is provided only for your convenience and may be superseded by updates. It is your responsibility to ensure that your application meets with your specifications. MICROCHIP MAKES NO REPRESENTATIONS OR WARRANTIES OF ANY KIND WHETHER EXPRESS OR IMPLIED, WRITTEN OR ORAL, STATUTORY OR OTHERWISE, RELATED TO THE INFORMATION, INCLUDING BUT NOT LIMITED TO ITS CONDITION, QUALITY, PERFORMANCE, MERCHANTABILITY OR FITNESS FOR PURPOSE. Microchip disclaims all liability arising from this information and its use. Use of Microchip devices in life support and/or safety applications is entirely at the buyer's risk, and the buyer agrees to defend, indemnify and hold harmless Microchip from any and all damages, claims, suits, or expenses resulting from such use. No licenses are conveyed, implicitly or otherwise, under any Microchip intellectual property rights.

Trademarks

The Microchip name and logo, the Microchip logo, Accuron, dsPIC, KEELOQ, KEELOQ logo, microID, MPLAB, PIC, PICmicro, PICSTART, PRO MATE, rPIC and SmartShunt are registered trademarks of Microchip Technology Incorporated in the U.S.A. and other countries.

AmpLab, FilterLab, Linear Active Thermistor, Migratable Memory, MXDEV, MXLAB, SEEVAL, SmartSensor and The Embedded Control Solutions Company are registered trademarks of Microchip Technology Incorporated in the U.S.A.

Analog-for-the-Digital Age, Application Maestro, CodeGuard, dsPICDEM, dsPICDEM.net, dsPICworks, dsSPEAK, ECAN, ECONOMONITOR, FanSense, FlexROM, fuzzyLAB, In-Circuit Serial Programming, ICSP, ICEPIC, Mindi, MiWi, MPASM, MPLAB Certified logo, MPLIB, MPLINK, PICkit, PICDEM, PICDEM.net, PICLAB, PICtail, PowerCal, PowerInfo, PowerMate, PowerTool, REAL ICE, rLAB, Select Mode, Smart Serial, SmartTel, Total Endurance, UNI/O, WiperLock and ZENA are trademarks of Microchip Technology Incorporated in the U.S.A. and other countries.

SQTP is a service mark of Microchip Technology Incorporated in the U.S.A.

All other trademarks mentioned herein are property of their respective companies.

© 2007, Microchip Technology Incorporated, Printed in the U.S.A., All Rights Reserved.

 Printed on recycled paper.

**QUALITY MANAGEMENT SYSTEM
CERTIFIED BY DNV
== ISO/TS 16949:2002 ==**

Microchip received ISO/TS-16949:2002 certification for its worldwide headquarters, design and wafer fabrication facilities in Chandler and Tempe, Arizona; Gresham, Oregon and design centers in California and India. The Company's quality system processes and procedures are for its PIC® MCUs and dsPIC® DSCs, KEELOQ® code hopping devices, Serial EEPROMs, microperipherals, nonvolatile memory and analog products. In addition, Microchip's quality system for the design and manufacture of development systems is ISO 9001:2000 certified.



WORLDWIDE SALES AND SERVICE

AMERICAS

Corporate Office
2355 West Chandler Blvd.
Chandler, AZ 85224-6199
Tel: 480-792-7200
Fax: 480-792-7277
Technical Support:
<http://support.microchip.com>
Web Address:
www.microchip.com

Atlanta

Duluth, GA
Tel: 678-957-9614
Fax: 678-957-1455

Boston

Westborough, MA
Tel: 774-760-0087
Fax: 774-760-0088

Chicago

Itasca, IL
Tel: 630-285-0071
Fax: 630-285-0075

Dallas

Addison, TX
Tel: 972-818-7423
Fax: 972-818-2924

Detroit

Farmington Hills, MI
Tel: 248-538-2250
Fax: 248-538-2260

Kokomo

Kokomo, IN
Tel: 765-864-8360
Fax: 765-864-8387

Los Angeles

Mission Viejo, CA
Tel: 949-462-9523
Fax: 949-462-9608

Santa Clara

Santa Clara, CA
Tel: 408-961-6444
Fax: 408-961-6445

Toronto

Mississauga, Ontario,
Canada
Tel: 905-673-0699
Fax: 905-673-6509

ASIA/PACIFIC

Asia Pacific Office
Suites 3707-14, 37th Floor
Tower 6, The Gateway
Harbour City, Kowloon
Hong Kong
Tel: 852-2401-1200
Fax: 852-2401-3431

Australia - Sydney
Tel: 61-2-9868-6733
Fax: 61-2-9868-6755

China - Beijing
Tel: 86-10-8528-2100
Fax: 86-10-8528-2104

China - Chengdu
Tel: 86-28-8665-5511
Fax: 86-28-8665-7889

China - Fuzhou
Tel: 86-591-8750-3506
Fax: 86-591-8750-3521

China - Hong Kong SAR
Tel: 852-2401-1200
Fax: 852-2401-3431

China - Nanjing
Tel: 86-25-8473-2460
Fax: 86-25-8473-2470

China - Qingdao
Tel: 86-532-8502-7355
Fax: 86-532-8502-7205

China - Shanghai
Tel: 86-21-5407-5533
Fax: 86-21-5407-5066

China - Shenyang
Tel: 86-24-2334-2829
Fax: 86-24-2334-2393

China - Shenzhen
Tel: 86-755-8203-2660
Fax: 86-755-8203-1760

China - Shunde
Tel: 86-757-2839-5507
Fax: 86-757-2839-5571

China - Wuhan
Tel: 86-27-5980-5300
Fax: 86-27-5980-5118

China - Xian
Tel: 86-29-8833-7252
Fax: 86-29-8833-7256

ASIA/PACIFIC

India - Bangalore
Tel: 91-80-4182-8400
Fax: 91-80-4182-8422

India - New Delhi
Tel: 91-11-4160-8631
Fax: 91-11-4160-8632

India - Pune
Tel: 91-20-2566-1512
Fax: 91-20-2566-1513

Japan - Yokohama
Tel: 81-45-471- 6166
Fax: 81-45-471-6122

Korea - Daegu
Tel: 82-53-744-4301
Fax: 82-53-744-4302

Korea - Seoul
Tel: 82-2-554-7200
Fax: 82-2-558-5932 or
82-2-558-5934

Malaysia - Kuala Lumpur
Tel: 60-3-6201-9857
Fax: 60-3-6201-9859

Malaysia - Penang
Tel: 60-4-227-8870
Fax: 60-4-227-4068

Philippines - Manila
Tel: 63-2-634-9065
Fax: 63-2-634-9069

Singapore
Tel: 65-6334-8870
Fax: 65-6334-8850

Taiwan - Hsin Chu
Tel: 886-3-572-9526
Fax: 886-3-572-6459

Taiwan - Kaohsiung
Tel: 886-7-536-4818
Fax: 886-7-536-4803

Taiwan - Taipei
Tel: 886-2-2500-6610
Fax: 886-2-2508-0102

Thailand - Bangkok
Tel: 66-2-694-1351
Fax: 66-2-694-1350

EUROPE

Austria - Wels
Tel: 43-7242-2244-39
Fax: 43-7242-2244-393

Denmark - Copenhagen
Tel: 45-4450-2828
Fax: 45-4485-2829

France - Paris
Tel: 33-1-69-53-63-20
Fax: 33-1-69-30-90-79

Germany - Munich
Tel: 49-89-627-144-0
Fax: 49-89-627-144-44

Italy - Milan
Tel: 39-0331-742611
Fax: 39-0331-466781

Netherlands - Drunen
Tel: 31-416-690399
Fax: 31-416-690340

Spain - Madrid
Tel: 34-91-708-08-90
Fax: 34-91-708-08-91

UK - Wokingham
Tel: 44-118-921-5869
Fax: 44-118-921-5820

10/05/07