

SPECIFICATION

Part No.	:	AP.35A.07.0054A
Spec No.	:	AP.35A
Product Name	:	35mm One Stage GPS Active Patch Antenna Module with back-end Saw Filter
Features	:	35mm*35mm*5.5mm (Ground Plane) 54mm Ø1.13 I-PEX MHFI (U.FL) 15dB LNA ROHS Compliant
Photo	:	

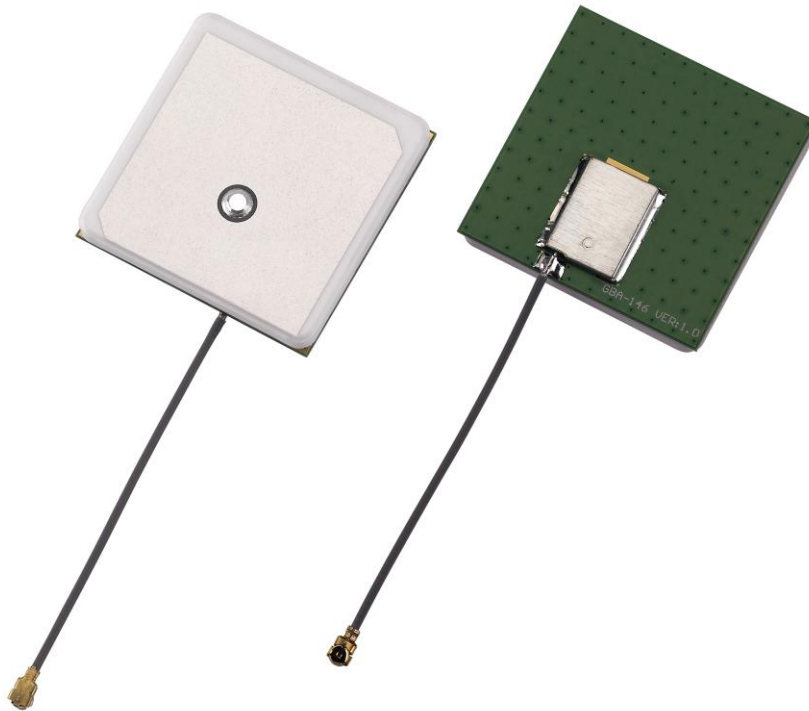

1. Introduction

The AP.35A has been designed for embedded (inside device) integration with GPS receiver modules, the AP.35A combines a 35*35*3.5mm advanced low profile ceramic patch antenna with a one stage LNA and ultra thin coaxial cable.

The Ground Plane size of 35*35mm combined with the larger size GPS Patch, gives this solution a performance increase in gain of 1~2dB. It also helps shields the patch antenna from noise and increases performance at low elevations.. Taoglas active antenna modules utilise XtremeGain™ technology for the highest sensitivity in the industry.

This antenna system consists of two functional blocks, the LNA portion and the patch antenna. The AP.35A has a back-end SAW filter.

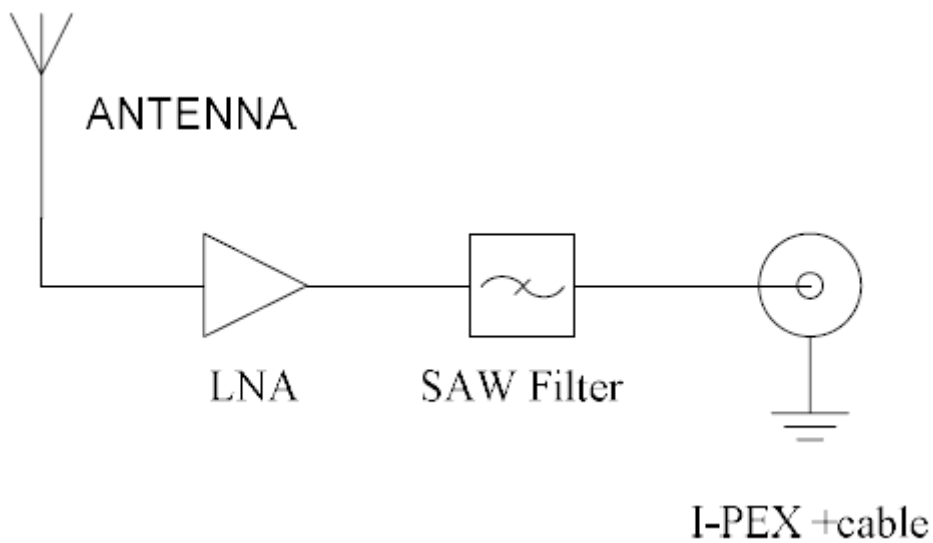

2. Specification

2.1 Patch Antenna

Parameter	Specification
Frequency	1575.42 ± 1.023MHz
Gain @ Zenith	+2.5 dBic Typ. @ Zenith (35mm GP)
Polarization	RHCP
Axial Ratio	3.0dB max. @Zenith
Patch Dimension	35*35*3.5mm

2.2 LNA

Parameter	Specification
Frequency	1575.42 ± 1.023MHz
Outer Band Attenuation	F0=1575.42MHz
	F0±30MHz 5dB min.
	F0±50MHz 23dB min.
	F0±100MHz 28dB min.
Output Impedance	50Ω
Output VSWR	2.0 Max
Pout at 1dB Gain Compression point	Typ. -2dBm Min. -6dBm
LNA Gain, Power Consumption and Noise Figure	
	LNA Gain Power Consumption(mA) Noise Figure
Voltage	(Typ) Typ Typ
Min. 1.8V	14dB 3mA 1.5dB
Typ. 3.0V	15dB 3mA 1.5dB
Max. 5.5V	15dB 3mA 1.5dB

2.3 Cable & Connector

Parameter	Specification
RF Cable	Coaxial Cable Ø1.13 ± 0.1mm, length 54 ± 2.5mm
Connector	IPEX MHFI (U.FL)

2.4 Total Specification (through Antenna, LNA, Cable and Connector)

Parameter	Specification
Frequency	1575.42 ± 1.023MHz
Gain	At 90° At 5V: 18± 3dBic At 3V: 17.5 ± 3dBic At 1.8V: 15.5 ± 3dBic
Output Impedance	50Ω
Polarization	RHCP
Output VSWR	Max 2.0
Operation Temperature	-40°C to + 85°C
Storage Temperature	-40°C to + 85°C
Relative Humidity	40% to 95%
Input Voltage	Min:1.8V Typ. 3.0V Max:5V
Antenna	35*35*5.5mm

3. Technical Drawing

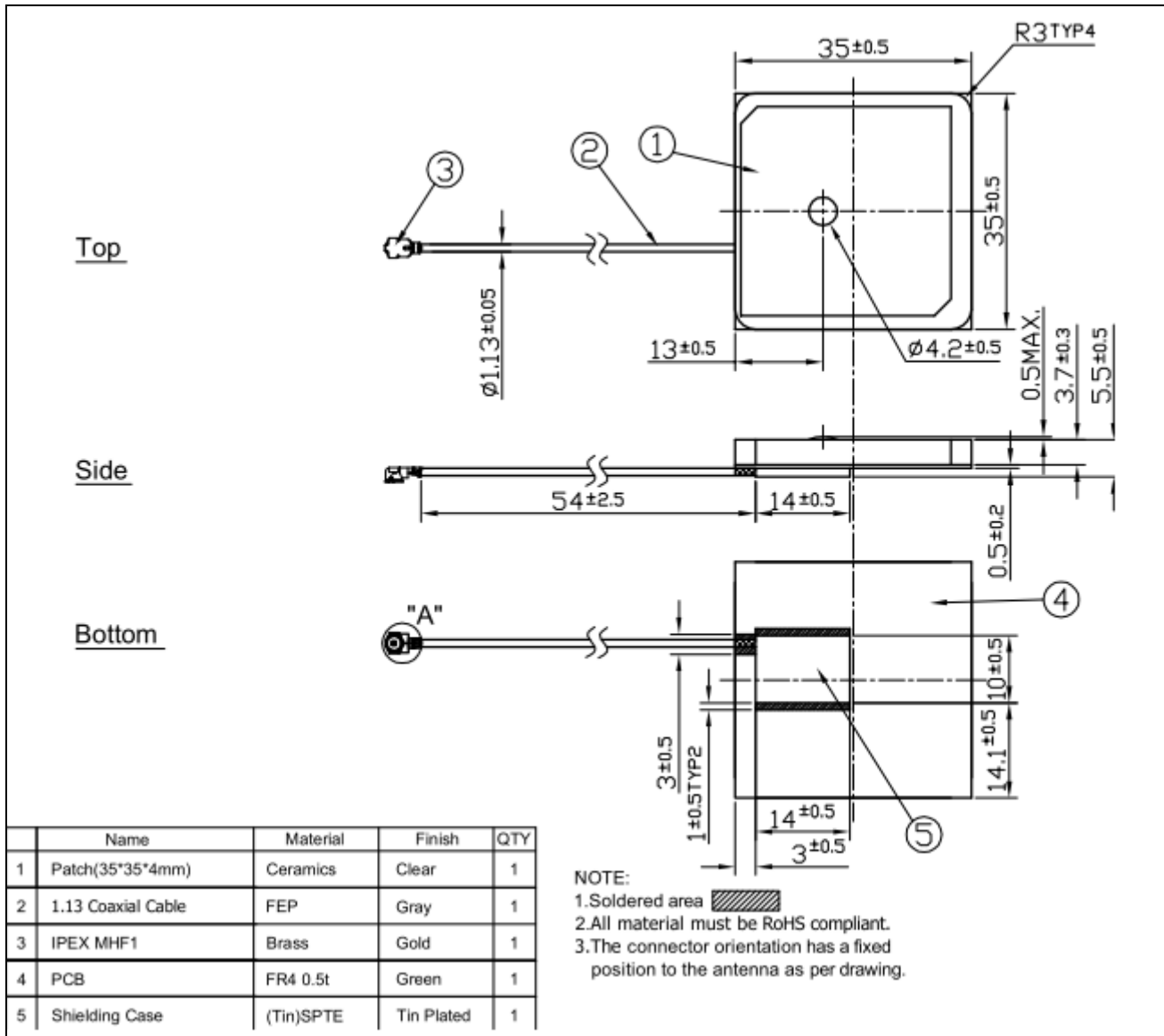

4. Radiation Patterns

4.1 XZ

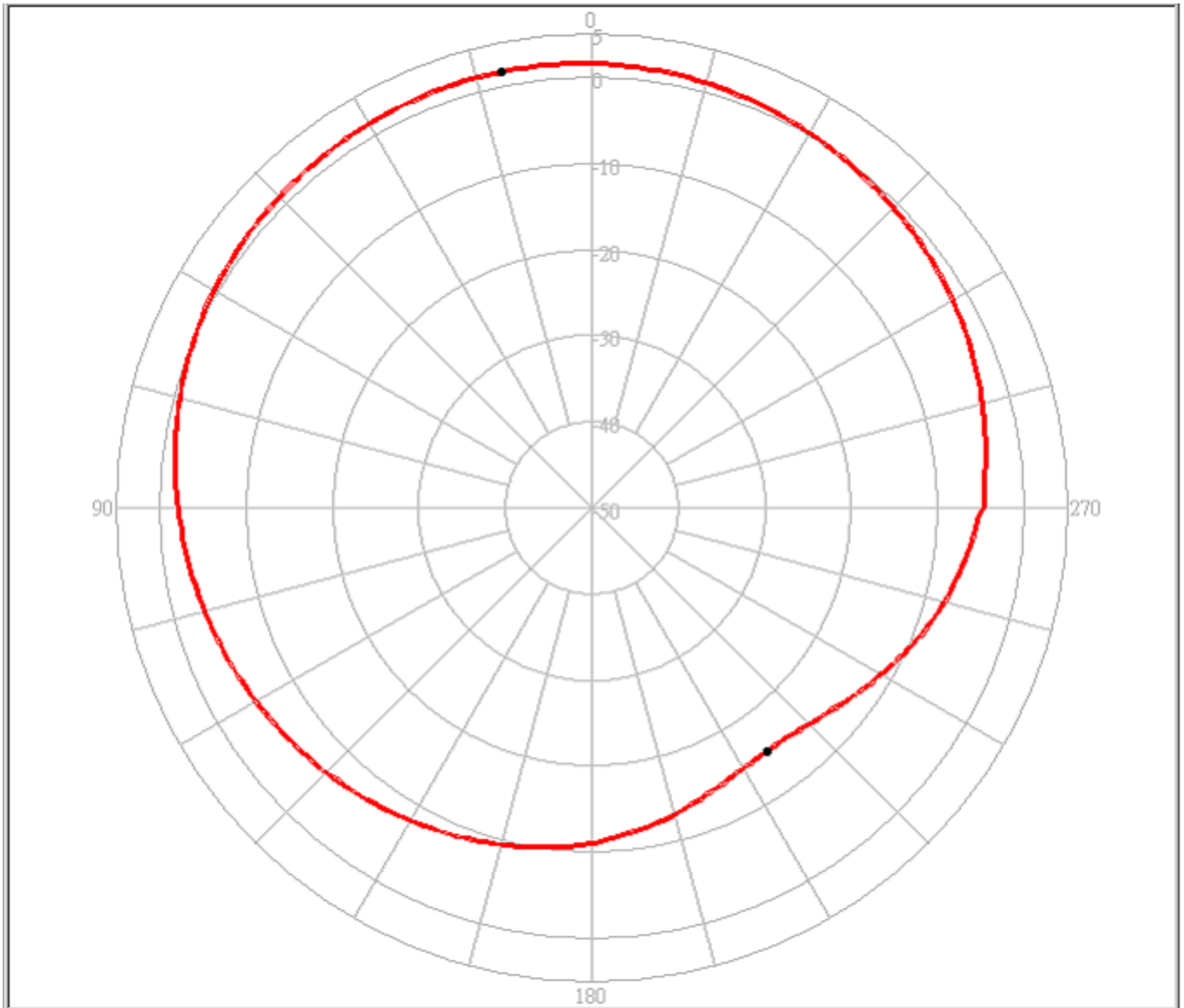

Pattern	Model No.	Test Mode	Freq(MHz)	Max Gain(dBi)	Min Gain(dBi)	Avg. Gain(dBi)	Source Polar.	Date
1	AP.35A	XZ	1575.42	1.65 / 11.56	-15.22 / 215.70	-2.22	RHCP	2010/1/14

4.2 YZ

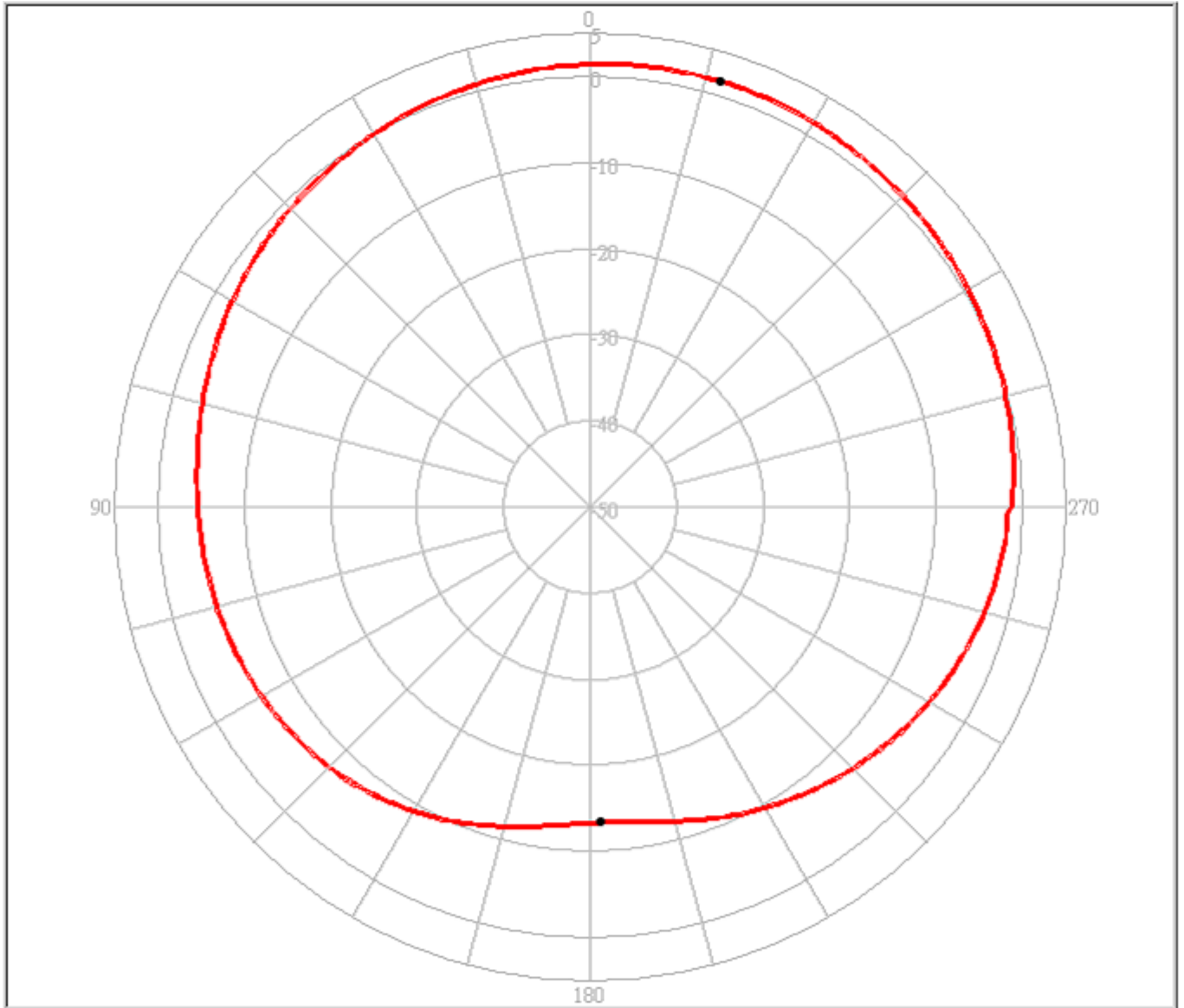

Pattern	Model No.	Test Mode	Freq(MHz)	Max Gain(dBi)	Min Gain(dBi)	Avg. Gain(dBi)	Source Polar.	Date
1	AP.35A	YZ	1575.42	1.62 / 343.00	-13.37 / 182.00	-2.08	RHCP	2010/1/14

4.3 XY

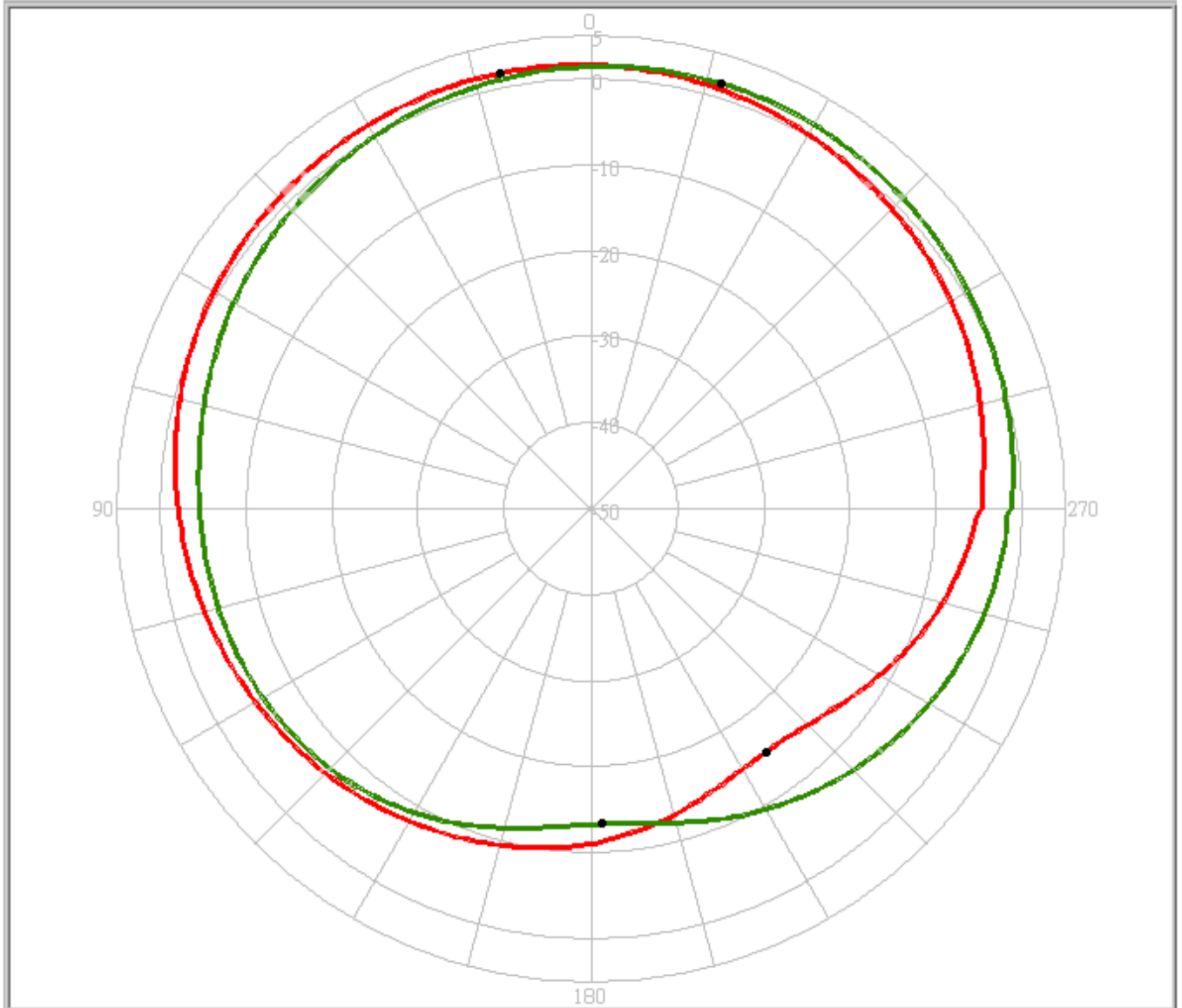

Pattern	Model No.	Test Mode	Freq(MHz)	Max Gain(dBi)	Min Gain(dBi)	Avg. Gain(dBi)	Source Polar.	Date
1	AP.35A	XZ	1575.42	1.65 / 11.56	-15.22 / 215.70	-2.22	RHCP	2010/1/14
2	AP.35A	YZ	1575.42	1.62 / 343.00	-13.37 / 182.00	-2.08	RHCP	2010/1/14

5. Axial Ratio

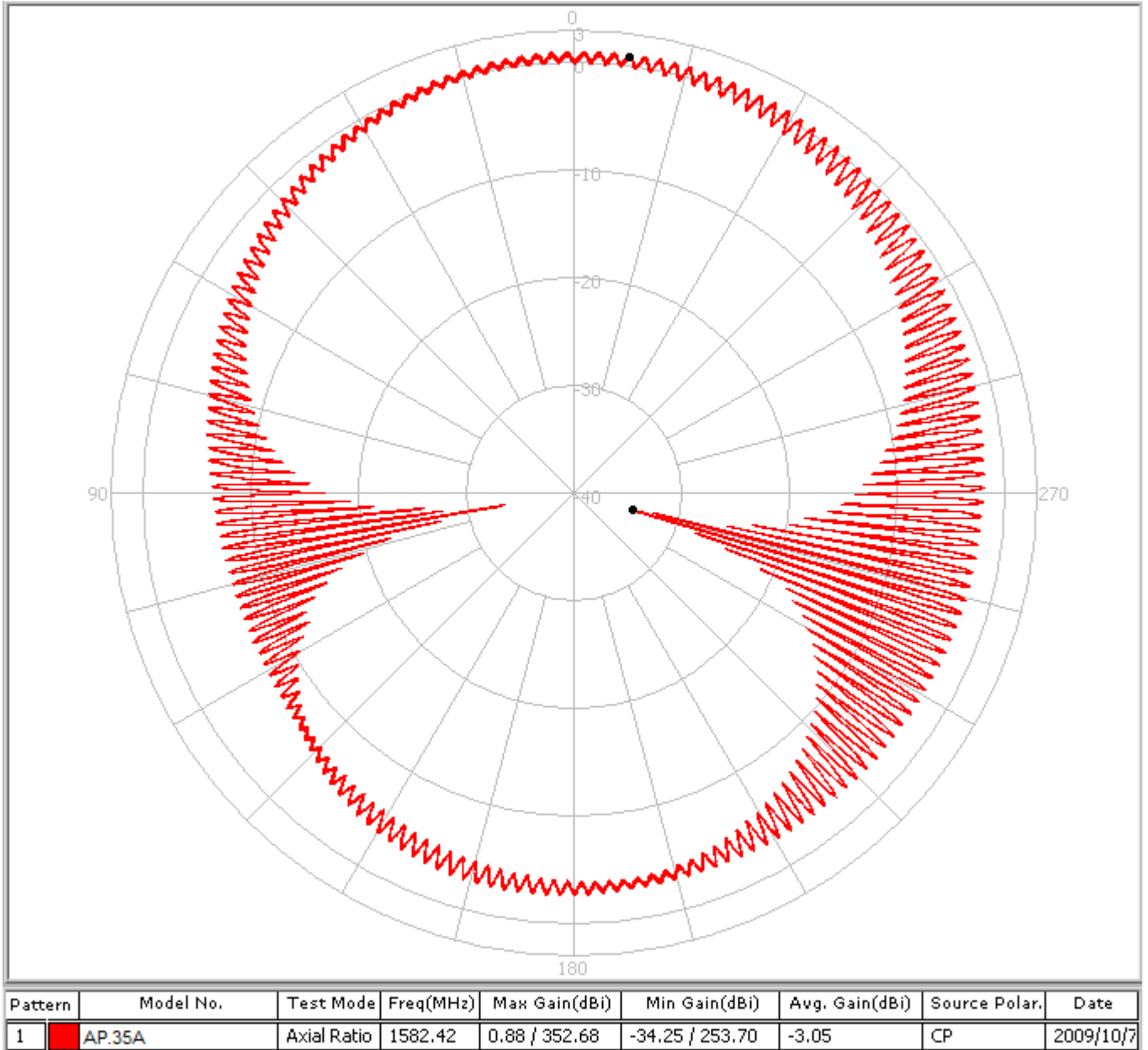

6. LNA Gain and Out of Band Rejection at 3.0V

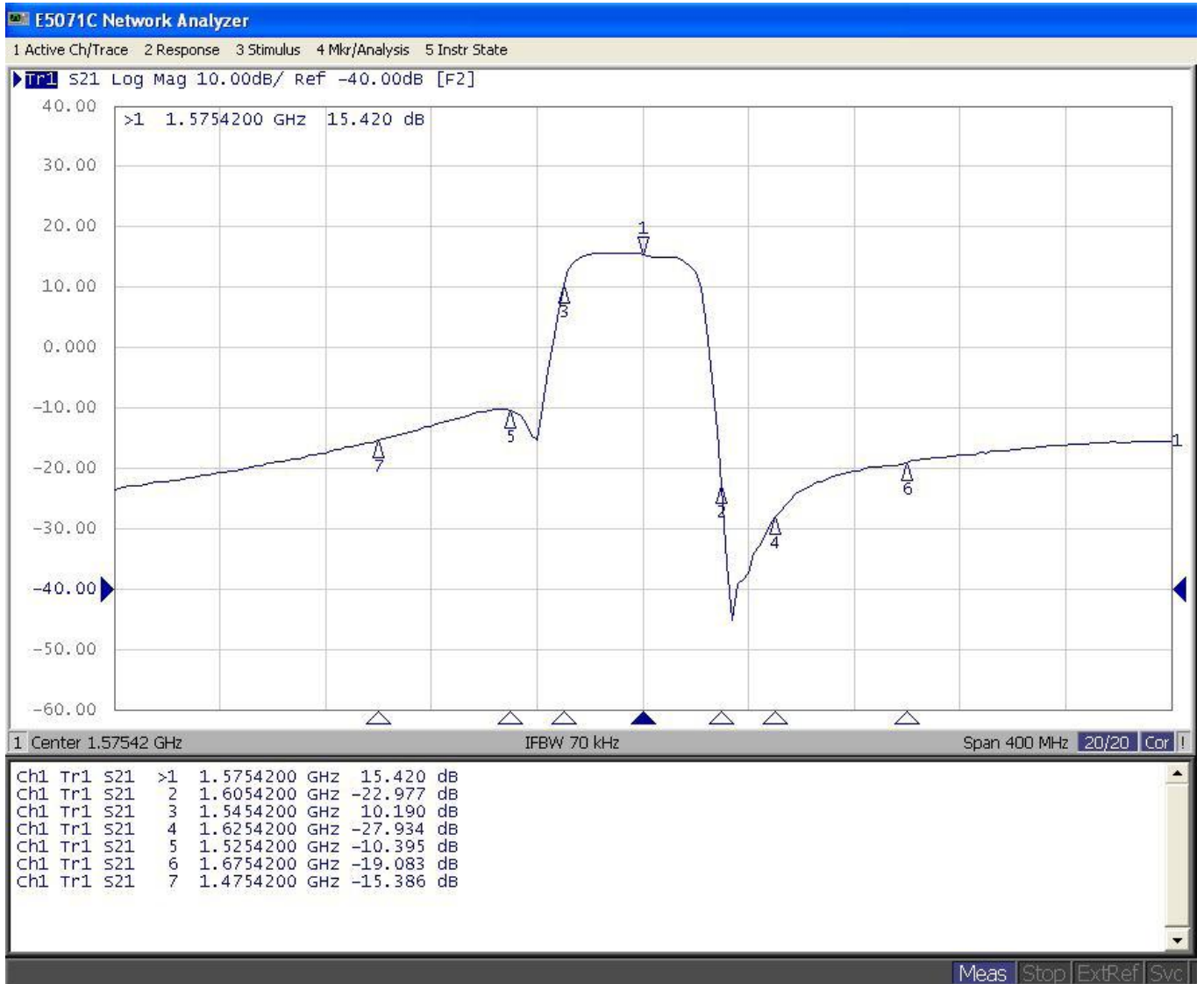

7. LNA Noise Figure at 3.0V

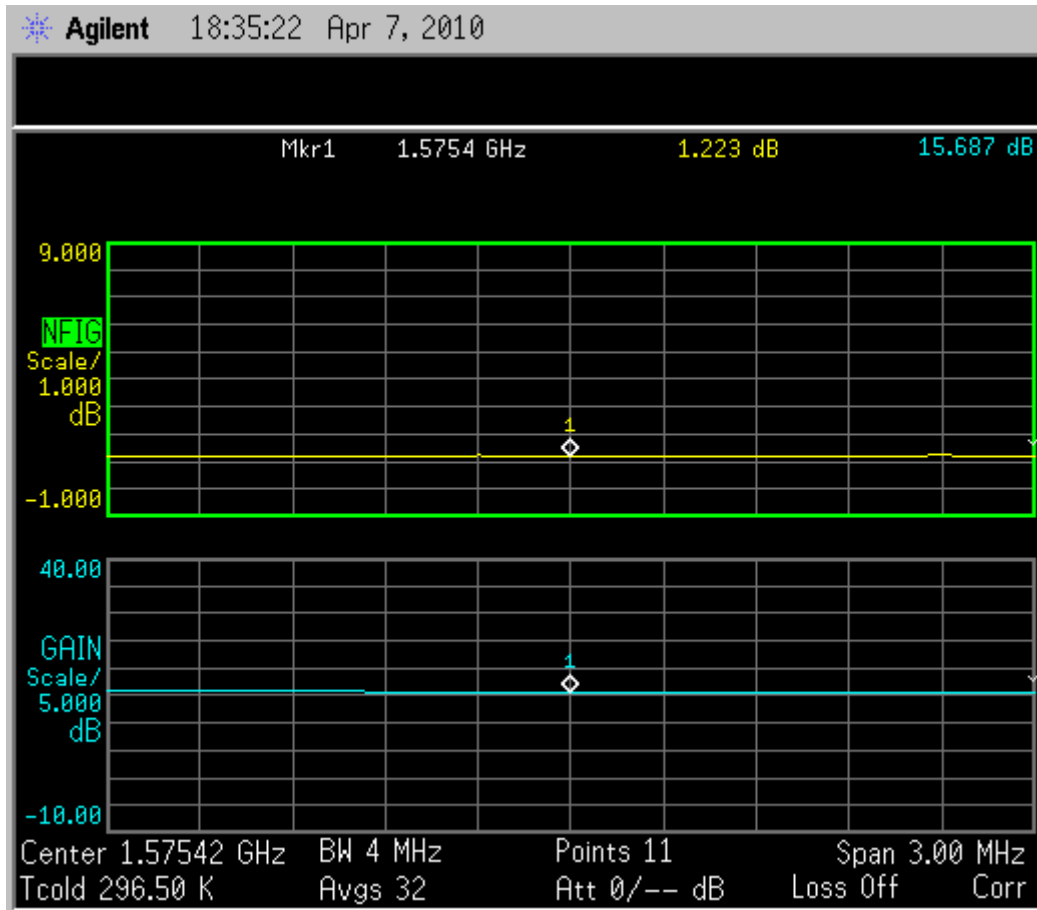

8. Reliability Tests

8.1 Reliability Test (Room temperature +25°C)

8.1.1 S21 Radiation Gain at +25°C

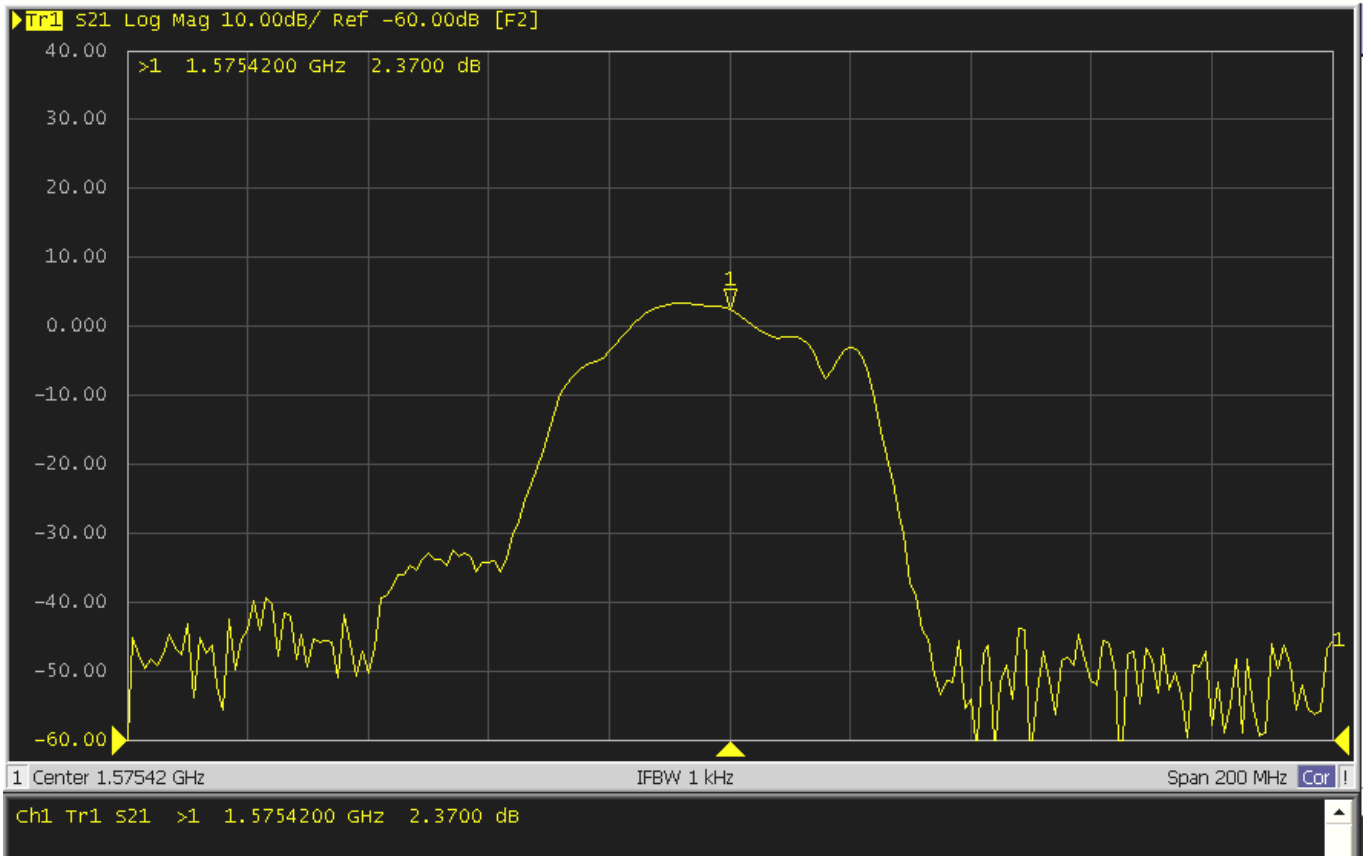

8.1.2 C/N at +25°C

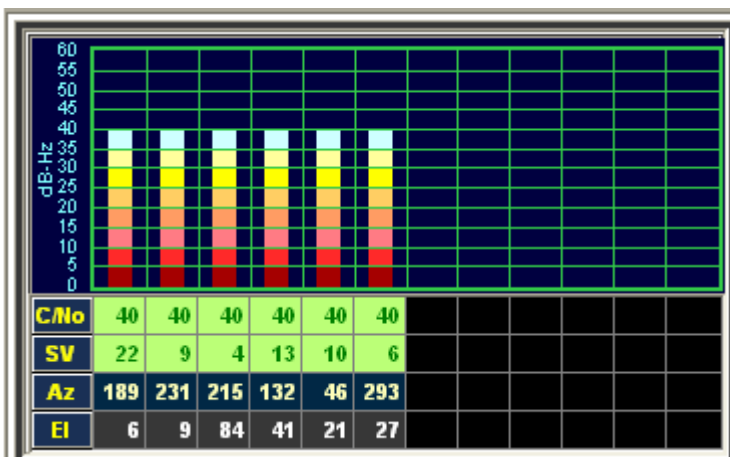

8.2 Reliability Test (High temperature +85°C)

8.2.1 S21 Radiation Gain at +85°C

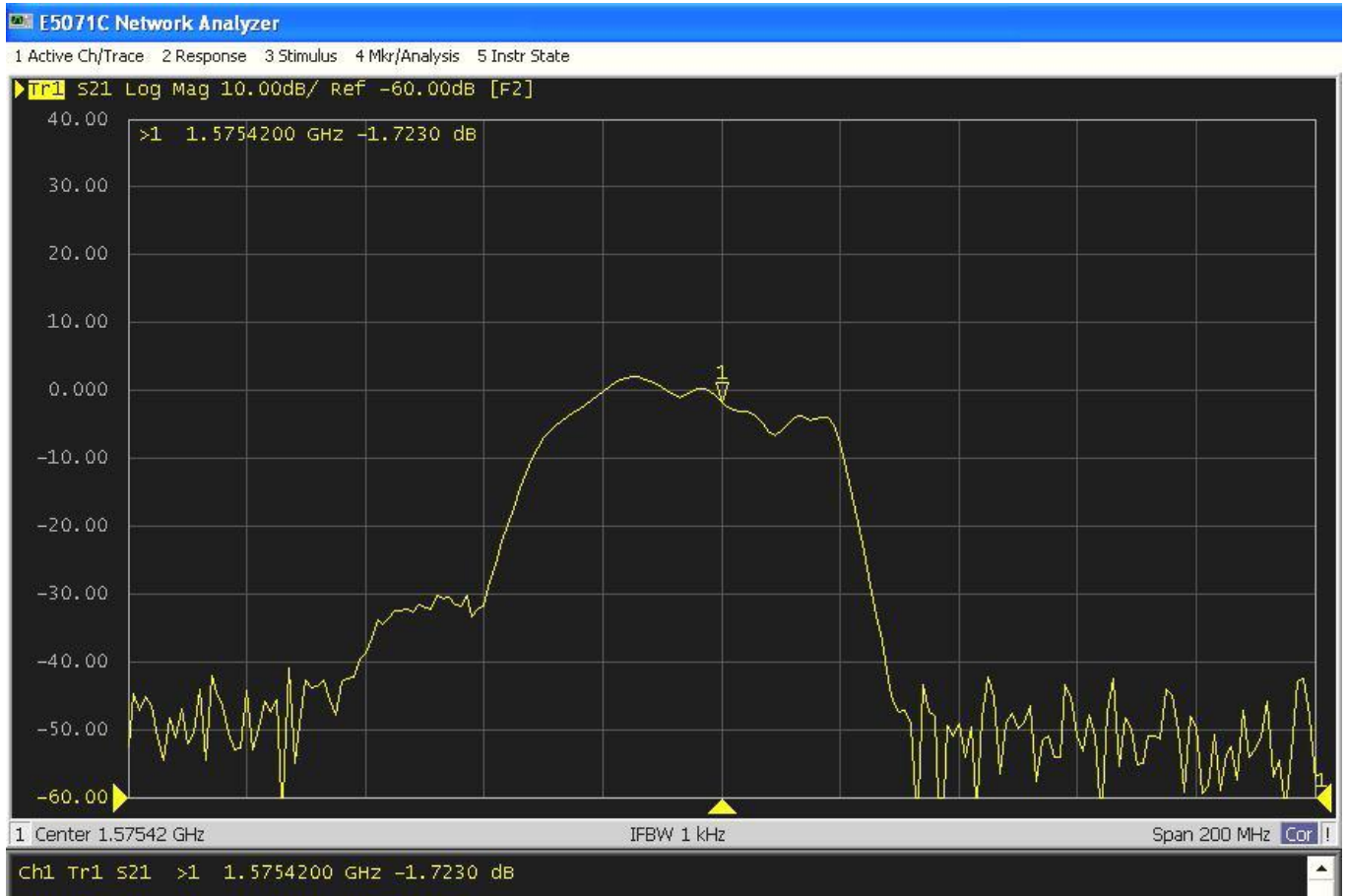

8.2.2 C/N at +85°C

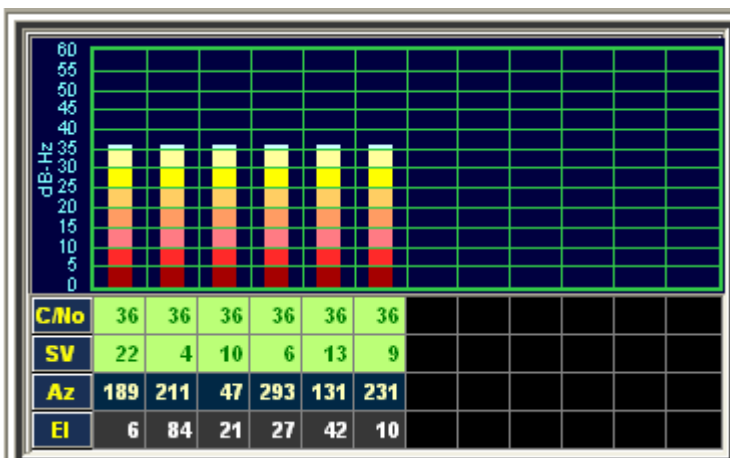

8.3 Reliability Test (Low temperature -40°C)

8.3.1 S21 Radiation Gain at -40°C

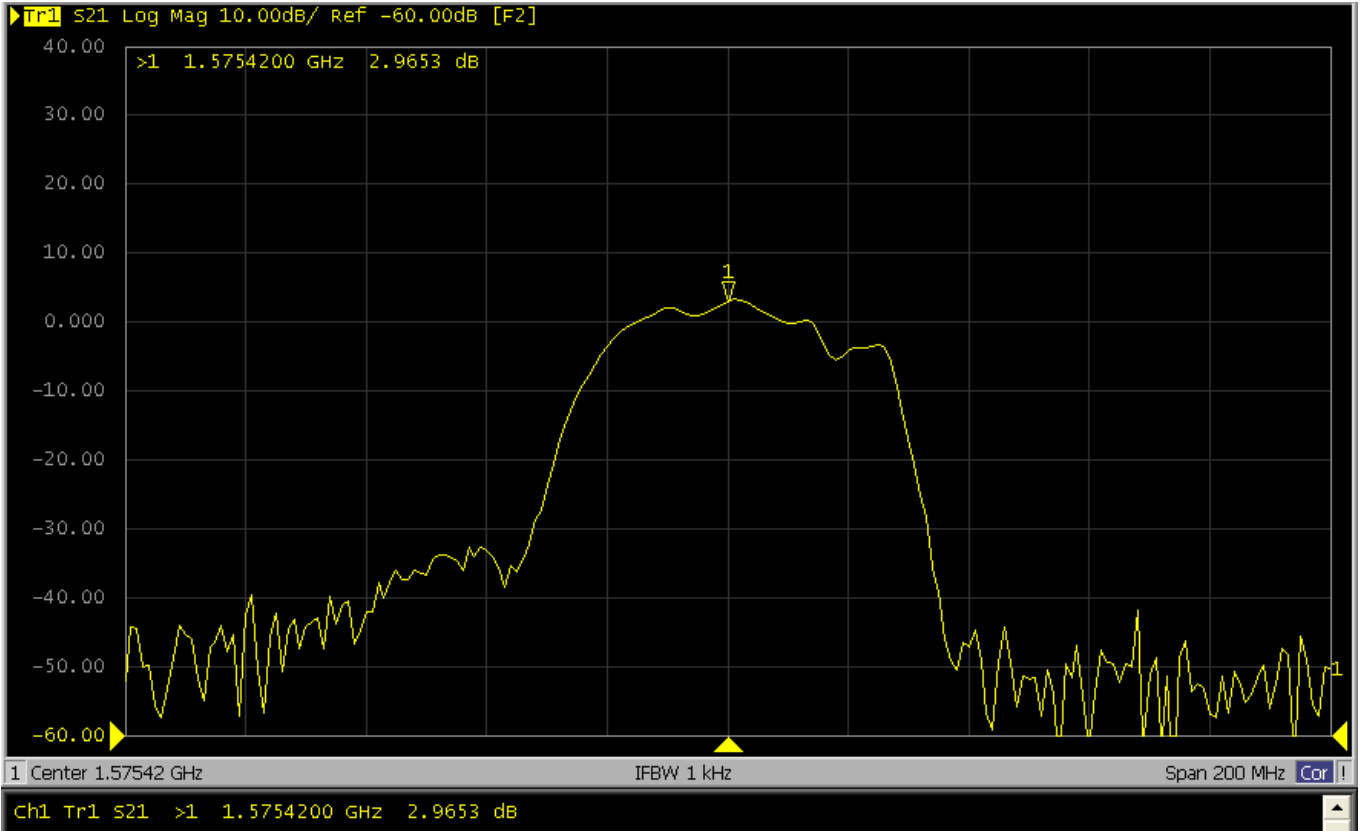

8.3.2 C/N at -40°C

