

8-bit Proprietary Microcontrollers

CMOS

F²MC-8FX MB95110A Series

MB95116A/F118AS/F118AW/FV100B-101

■ DESCRIPTION

The MB95110A series is general-purpose, single-chip microcontrollers. In addition to a compact instruction set, the microcontrollers contain a variety of peripheral functions.

Note : F²MC is the abbreviation of FUJITSU Flexible Microcontroller.

■ FEATURES

- F²MC-8FX CPU core
 - Instruction set that is optimum to the controllers
 - Multiplication and division instructions
 - 16-bit arithmetic operation
 - Bit test branch instruction
 - Bit manipulation instructions etc.
- Clock
 - Main clock
 - Main PLL clock
 - Subclock (for dual clock product)
 - Sub PLL clock (for dual clock product)

(Continued)

Be sure to refer to the "Check Sheet" for the latest cautions on development.

"Check Sheet" is seen at the following support page

URL : <http://www.fujitsu.com/global/services/microelectronics/product/micom/support/index.html>

"Check Sheet" lists the minimal requirement items to be checked to prevent problems beforehand in system development.

MB95110A Series

(Continued)

- Timer
 - 8/16-bit compound timer × 2 channels
 - 8/16-bit PPG × 2 channels
 - 16-bit PPG
 - Timebase timer
 - Watch prescaler (for dual clock product)
- LIN-UART
 - Full duplex double buffer
 - Clock asynchronous or Clock synchronous serial data transfer capable
- UART/SIO
 - Full duplex double buffer
 - Clock asynchronous or Clock synchronous serial data transfer capable
- I²C*
 - Built-in wake-up function
- External interrupt
 - Interrupt by edge detection (rising, falling, or both edges can be selected)
 - Can be used to recover from low-power consumption (standby) modes.
- 8/10-bit A/D converter
 - 8-bit or 10-bit resolution can be selected
- Low-power consumption (standby) mode
 - Stop mode
 - Sleep mode
 - Watch mode (for dual clock product)
 - Timebase timer mode
- I/O port:
 - The number of maximum ports
 - Single clock product : 39 ports
 - Dual clock product : 37 ports
 - Port configuration
 - General-purpose I/O ports (N-ch open drain) : 2 ports
 - General-purpose I/O ports (CMOS) : Single clock product : 37 ports
Dual clock product : 35 ports

* : Purchase of Fujitsu I²C components conveys a license under the Philips I²C Patent Rights to use, these components in an I²C system provided that the system conforms to the I²C Standard Specification as defined by Philips.

MB95110A Series

■ PRODUCT LINEUP

Part number		MB95116A	MB95F118AS	MB95F118AW
Parameter				
Type		MASK ROM product	Flash memory product	
ROM capacity		32 Kbytes	60 Kbytes	
RAM capacity		1 Kbyte	2 Kbytes	
Reset output		No		
Option*1	Clock system	Selectable single/dual clock*2	Single clock	Dual clock
	Low voltage detection reset	No		
CPU functions		Number of basic instructions : 136 Instruction bit length : 8 bits Instruction length : 1 to 3 bytes Data bit length : 1, 8, and 16 bits Minimum instruction execution time : 0.1 μs (at machine clock frequency 10 MHz) Interrupt processing time : 0.9 μs (at machine clock frequency 10 MHz)		
Peripheral functions	General-purpose I/O port	<ul style="list-style-type: none"> • Single clock product : 39 ports (N-ch open drain : 2 ports, CMOS : 37 ports) • Dual clock product : 37 ports (N-ch open drain : 2 ports, CMOS : 35 ports) 		
	Timebase timer	Interrupt cycle : 0.5 ms, 2.1 ms, 8.2 ms, 32.8 ms (at main oscillation clock 4 MHz)		
	Watchdog timer	Reset generated cycle At main oscillation clock 10 MHz : Minimum 105 ms At sub oscillation clock 32.768 kHz (for dual clock product) : Minimum 250 ms		
	Wild register	Capable of replacing 3 bytes of ROM data		
	I ² C	Master/slave sending and receiving Bus error function and arbitration function Detecting transmitting direction function Start condition repeated generation and detection functions Built-in wake-up function		
	UART/SIO	Data transfer capable in UART/SIO Full duplex double buffer, variable data length (5/6/7/8-bit), built-in baud rate generator Transfer rate : 2400 bps to 1250000 bps (at machine clock 10 MHz) NRZ type transfer format, error detected function LSB-first or MSB-first can be selected. Clock synchronous (SIO) or clock asynchronous (UART) serial data transfer capable		
	LIN-UART	Dedicated reload timer allowing a wide range of communication speeds to be set. Full duplex double buffer. Capable of serial data transfer synchronous or asynchronous to clock signal. LIN functions available as the LIN master or LIN slave.		
	8/10-bit A/D converter(8 channels)	8-bit or 10-bit resolution can be selected.		

(Continued)

MB95110A Series

(Continued)

Part number		MB95116A	MB95F118AS	MB95F118AW
Parameter				
Peripheral functions	8/16-bit compound timer (2 channels)	Each channel of the timer can be used as “8-bit timer × 2 channels” or “16-bit timer × 1 channel”. Built-in timer function, PWC function, PWM function, capture function and square waveform output Count clock : 7 internal clocks and external clock can be selected.		
	16-bit PPG	PWM mode or one-shot mode can be selected. Counter operating clock : 8 selectable clock sources Support for external trigger start		
	8/16-bit PPG (2 channels)	Each channel of the PPG can be used as “8-bit PPG × 2 channels” or “16-bit PPG × 1 channel”. Counter operating clock : Eight selectable clock sources		
	Watch counter (for dual clock product)	Count clock : Four selectable clock sources (125ms, 250ms, 500ms, or 1s) Counter value can be set from 0 to 63. (Capable of counting for 1 minute when selecting clock source 1 second and setting counter value to 60)		
	Watch prescaler (for dual clock product)	4 selectable interval times (125 ms, 250 ms, 500 ms, or 1 s)		
	External interrupt (8 channels)	Interrupt by edge detection (rising, falling, or both edges can be selected) Can be used to recover from standby modes.		
Standby mode		Sleep, stop, watch (for dual clock product) , and timebase timer		

*1 : For details of option, refer to “■ MASK OPTIONS”.

*2 : Specify clock mode when ordering MASK ROM.

Note : Part number of the evaluation device in MB95110A series is MB95FV100B-101. When using it, the MCU board (MB2146-301) is required.

■ SELECT OF OSCILLATION STABILIZATION WAIT TIME (MASK ROM PRODUCT ONLY)

For the MASK ROM product, you can set the mask option when ordering MASK ROM to select the initial value of main clock oscillation stabilization wait time from among the following four values.

Note that the Evaluation and Flash memory products are fixed their initial value of main clock oscillation stabilization wait time at the maximum value.

Selection of oscillation stabilization wait time	Remarks
$(2^2 - 2) / F_{CH}$	0.5 μ s (at main oscillation clock 4 MHz)
$(2^{12} - 2) / F_{CH}$	Approx. 1.02 ms (at main oscillation clock 4 MHz)
$(2^{13} - 2) / F_{CH}$	Approx. 2.05 ms (at main oscillation clock 4 MHz)
$(2^{14} - 2) / F_{CH}$	Approx. 4.10 ms (at main oscillation clock 4 MHz)

■ PACKAGES AND CORRESPONDING PRODUCTS

Part number Package	MB95116A	MB95F118AS	MB95F118AW	MB95FV100B-101
LCC-48P-M09	○	○	○	×
FPT-48P-M26	○	○	○	×
FPT-52P-M01	*	○	○	×
BGA-224P-M08	×	×	×	○

○ : Available

×

* : Under development

MB95110A Series

■ DIFFERENCES AMONG PRODUCTS AND NOTES ON SELECTING PRODUCTS

• Notes on Using Evaluation Products

The Evaluation product has not only the functions of the MB95110A corresponding products series but also those of other products to support software development for multiple series and models of the F²MC-8FX family. The I/O addresses for peripheral resources not used by the MB95110A series are therefore access-barred. Read/write access to these access-barred addresses may cause peripheral resources supposed to be unused to operate, resulting in unexpected malfunctions of hardware or software.

Particularly, do not use word access to odd numbered byte address in the prohibited areas (If these access are used, the address may be read or written unexpectedly).

Note that the values read from barred addresses are different between the Evaluation product and the Flash memory or MASK ROM product. Therefore, the data must not be used for software processing.

The Evaluation product do not support the functions of some bits in single-byte registers. Read/write access to these bits does not cause hardware malfunctions. The Evaluation, Flash memory, and MASK ROM products are designed to behave completely the same way in terms of hardware and software.

• Difference of Memory Spaces

If the amount of memory on the Evaluation product is different from that of the Flash memory or MASK ROM product, carefully check the difference in the amount of memory from the model to be actually used when developing software.

For details of memory space, refer to “■ CPU CORE”.

• Current Consumption

The current consumption of Flash memory product is greater than for MASK ROM product. For details of current consumption, refer to “■ ELECTRICAL CHARACTERISTICS”.

• Package

For details of information on each package, refer to “■ PACKAGE DIMENSIONS”.

• Operating voltage

The operating voltage are different among the Evaluation, Flash memory, and MASK ROM products.

For details of operating voltage, refer to “■ ELECTRICAL CHARACTERISTICS”

• Difference between \overline{RST} and MOD pins

The input type of \overline{RST} and MOD pins is CMOS input on the Flash memory product.

The \overline{RST} and MOD pins are hysteresis inputs on the MASK ROM product. A pull - down resistor is provided for the MOD pin of the MASK ROM product.

■ PIN ASSIGNMENTS

(TOP VIEW)

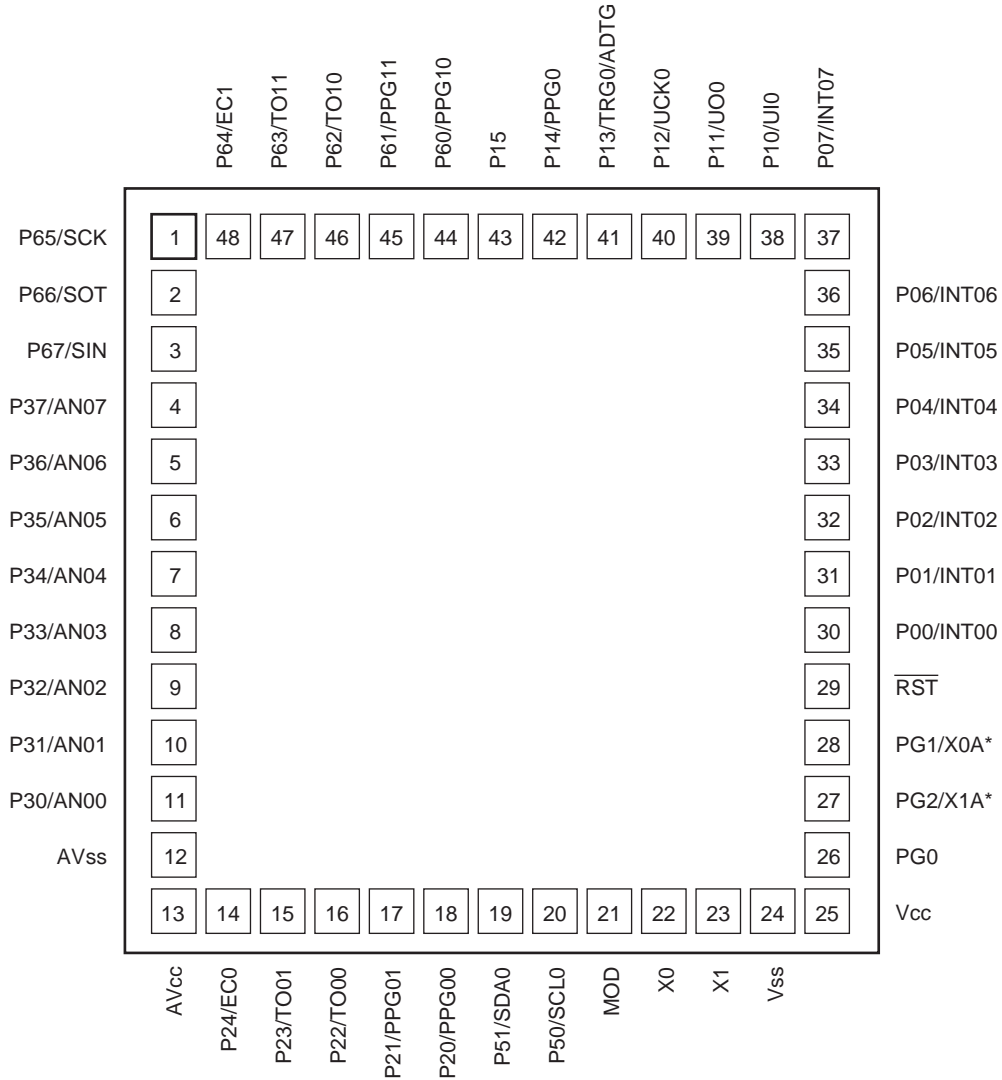

(LCC-48P-M09)

* : Single clock product is general-purpose port, and dual clock product is subclock oscillation pin.

(Continued)

MB95110A Series

(TOP VIEW)

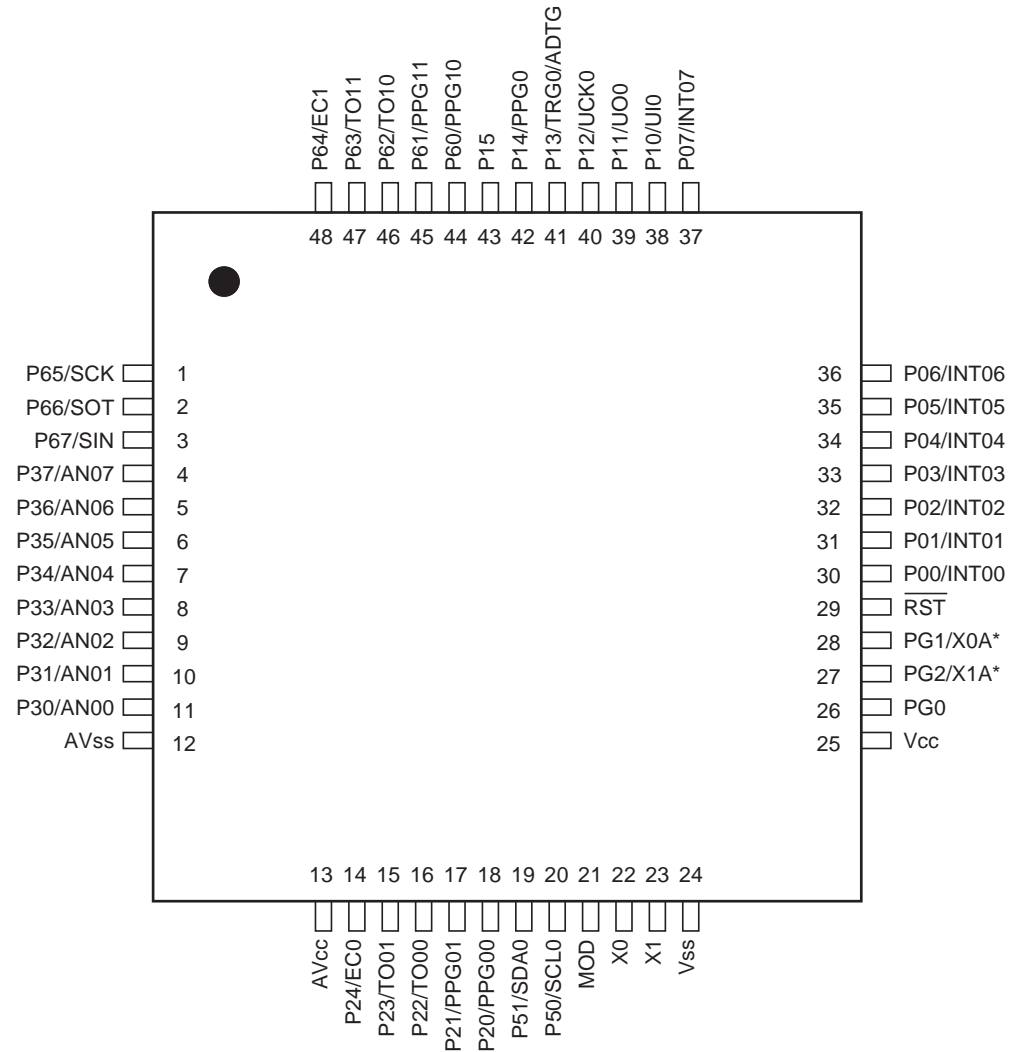

(FPT-48P-M26)

* : Single clock product is general-purpose port, and dual clock product is subclock oscillation pin.

(Continued)

(Continued)

(TOP VIEW)

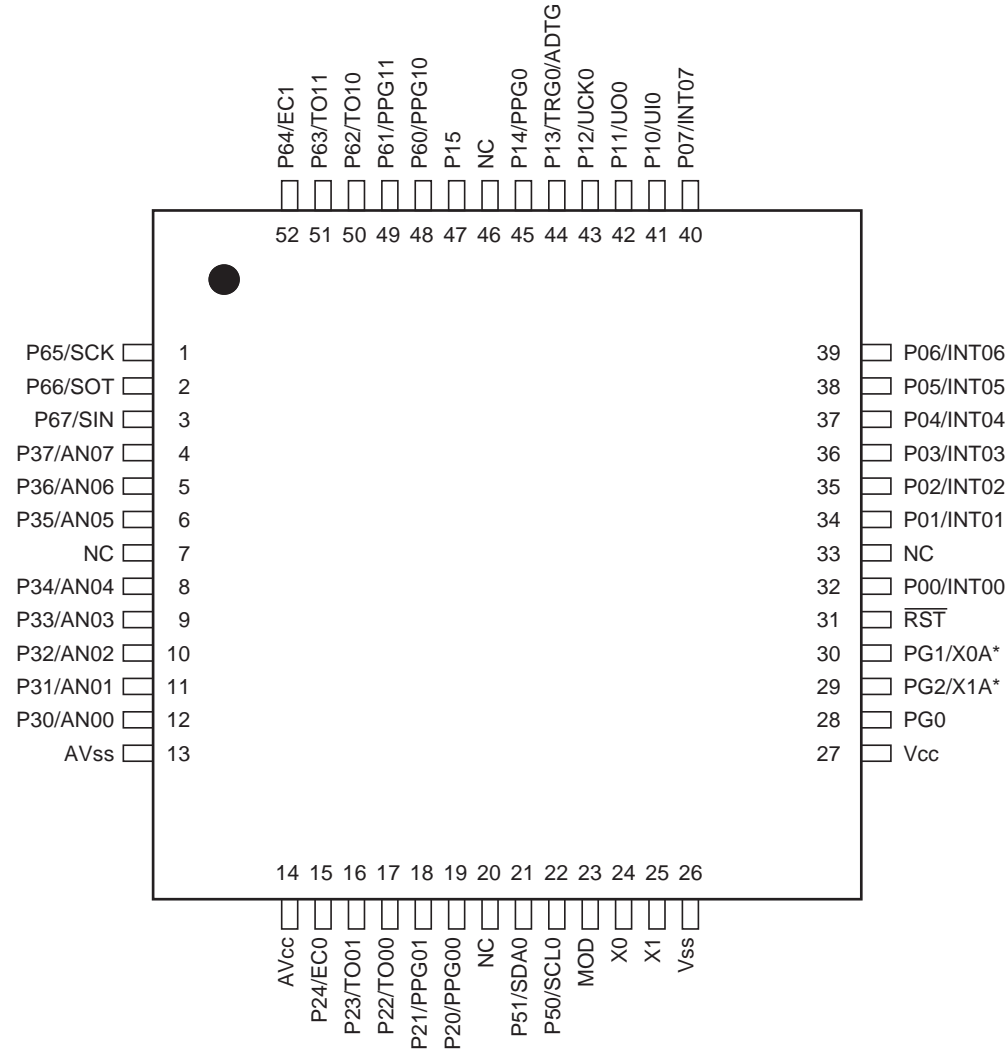

(FPT-52P-M01)

* : Single clock product is general-purpose port, and dual clock product is subclock oscillation pin.

MB95110A Series

■ PIN DESCRIPTION

Pin no.		Pin name	I/O Circuit type*3	Function
LQFP*1	LQFP*2			
1	1	P65/SCK	K	General-purpose I/O port. The pin is shared with LIN-UART clock I/O.
2	2	P66/SOT		General-purpose I/O port. The pin is shared with LIN-UART data output.
3	3	P67/SIN	L	General-purpose I/O port. The pin is shared with LIN-UART data input.
4	4	P37/AN07	J	General-purpose I/O port. The pins are shared with A/D converter analog input.
5	5	P36/AN06		
6	6	P35/AN05		
7	8	P34/AN04		
8	9	P33/AN03		
9	10	P32/AN02		
10	11	P31/AN01		
11	12	P30/AN00		
12	13	AVss	—	A/D converter power supply pin (GND)
13	14	AVcc	—	A/D converter power supply pin
14	15	P24/EC0	H	General-purpose I/O port. The pin is shared with 8/16-bit compound timer ch.0 clock input.
15	16	P23/TO01		General-purpose I/O port. The pins are shared with 8/16-bit compound timer ch.0 output.
16	17	P22/TO00		General-purpose I/O port. The pins are shared with 8/16-bit PPG ch.0 output.
17	18	P21/PPG01		
18	19	P20/PPG00		
19	21	P51/SDA0	I	General-purpose I/O port. The pin is shared with I ² C ch.0 data I/O.
20	22	P50/SCL0		General-purpose I/O port. The pin is shared with I ² C ch.0 clock I/O.
21	23	MOD	B	Operating mode designation pin
22	24	X0	A	Main clock input oscillation pin
23	25	X1		Main clock input/output oscillation pin
24	26	Vss	—	Power supply pin (GND)
25	27	Vcc	—	Power supply pin
26	28	PG0	H	General-purpose I/O port.

(Continued)

MB95110A Series

(Continued)

Pin no.		Pin name	I/O Circuit type*3	Function	
LQFP*1	LQFP*2				
27	29	PG2/X1A	H/A	Single clock product is general-purpose port (PG2) . Dual clock product is sub clock input/output oscillation pin (32 kHz).	
28	30	PG1/X0A		Single clock product is general-purpose port (PG1) . Dual clock product is sub clock input oscillation pin (32 kHz).	
29	31	RST	B'	Reset pin	
30	32	P00/INT00	C	General-purpose I/O port. The pins are shared with external interrupt input. Large current port.	
31	34	P01/INT01			
32	35	P02/INT02			
33	36	P03/INT03			
34	37	P04/INT04			
35	38	P05/INT05			
36	39	P06/INT06			
37	40	P07/INT07			
38	41	P10/UI0	G	General-purpose I/O port. The pin is shared with UART/SIO ch.0 data input.	
39	42	P11/UO0	H	General-purpose I/O port. The pin is shared with UART/SIO ch.0 data output.	
40	43	P12/UCK0		General-purpose I/O port. The pin is shared with UART/SIO ch.0 clock I/O.	
41	44	P13/TRG0/ ADTG		General-purpose I/O port. The pin is shared with 16-bit PPG ch.0 trigger input (TRG0) and A/D trigger input (ADTG).	
42	45	P14/PPG0		General-purpose I/O port. The pin is shared with 16-bit PPG ch.0 output.	
43	47	P15		General-purpose I/O port.	
44	48	P60/PPG10		K	General-purpose I/O port. The pins are shared with 8/16-bit PPG ch.1 output.
45	49	P61/PPG11	K		General-purpose I/O port. The pins are shared with 8/16-bit compound timer ch.1 output.
46	50	P62/TO10			
47	51	P63/TO11			
48	52	P64/EC1			
—	7, 20, 33, 46	NC	—	Internal connect pin. Be sure this pin is left open.	

*1 : FPT-48P-M26

*2 : FPT-52P-M01

*3: For the I/O circuit type, refer to "■ I/O CIRCUIT TYPE"

MB95110A Series

■ I/O CIRCUIT TYPE

Type	Circuit	Remarks
A		<ul style="list-style-type: none"> • Oscillation circuit • High-speed side Feedback resistance value : approx. 1 MΩ • Low-speed side Feedback resistance : approx. 24 MΩ (Evaluation product : approx. 10 MΩ) Dumping resistance : approx. 144 kΩ (Evaluation product : without dumping resistance)
B		<ul style="list-style-type: none"> • Only for input • Hysteresis input only for MASK ROM product • With pull-down resistor only for MASK ROM product
B'		Hysteresis input only for MASK ROM product
C		<ul style="list-style-type: none"> • CMOS output • Hysteresis input
G		<ul style="list-style-type: none"> • CMOS output • CMOS input • Hysteresis input • With pull-up control

(Continued)

(Continued)

Type	Circuit	Remarks
H		<ul style="list-style-type: none"> • CMOS output • Hysteresis input • With pull-up control
I		<ul style="list-style-type: none"> • N-ch open drain output • CMOS input • Hysteresis input
J		<ul style="list-style-type: none"> • CMOS output • Hysteresis input • Analog input • With pull-up control
K		<ul style="list-style-type: none"> • CMOS output • Hysteresis input
L		<ul style="list-style-type: none"> • CMOS output • CMOS input • Hysteresis input

MB95110A Series

■ HANDLING DEVICES

• Preventing Latch-up

Care must be taken to ensure that maximum voltage ratings are not exceeded when they are used.

Latch-up may occur on CMOS ICs if voltage higher than V_{CC} or lower than V_{SS} is applied to input and output pins other than medium- and high-withstand voltage pins or if higher than the rating voltage is applied between V_{CC} pin and V_{SS} pin.

When latch-up occurs, power supply current increases rapidly and might thermally damage elements.

Also, take care to prevent the analog power supply voltage (AV_{CC}) and analog input voltage from exceeding the digital power supply voltage (V_{CC}) when the analog system power supply is turned on or off.

• Stable Supply Voltage

Supply voltage should be stabilized.

A sudden change in power-supply voltage may cause a malfunction even within the guaranteed operating range of the V_{CC} power-supply voltage.

For stabilization, in principle, keep the variation in V_{CC} ripple (p-p value) in a commercial frequency range (50 Hz/60 Hz) not to exceed 10% of the standard V_{CC} value and suppress the voltage variation so that the transient variation rate does not exceed 0.1 V/ms during a momentary change such as when the power supply is switched.

• Precautions for Use of External Clock

Even when an external clock is used, oscillation stabilization wait time is required for power-on reset, wake-up from subclock mode or stop mode.

■ PIN CONNECTION

• Treatment of Unused Input Pin

Leaving unused input pins unconnected can cause abnormal operation or latch-up, leaving to permanent damage. Unused input pins should always be pulled up or down through resistance of at least 2 k Ω .

Any unused input/output pins may be set to output mode and left open, or set to input mode and treated the same as unused input pins. If there is unused output pin, make it to open.

• Treatment of Power Supply Pins on A/D Converter

Connect to be $AV_{CC} = V_{CC}$ and $AV_{SS} = V_{SS}$ even if the A/D converter is not in use.

Noise riding on the AV_{CC} pin may cause accuracy degradation. So, connect approx. 0.1 μ F ceramic capacitor as a bypass capacitor between AV_{CC} and AV_{SS} pins in the vicinity of this device.

• Power Supply Pins

In products with multiple V_{CC} or V_{SS} pins, the pins of the same potential are internally connected in the device to avoid abnormal operations including latch-up. However, you must connect the pins to external power supply and a ground line to lower the electro-magnetic emission level, to prevent abnormal operation of strobe signals caused by the rise in the ground level, and to conform to the total output current rating.

Moreover, connect the current supply source with the V_{CC} and V_{SS} pins of this device at the low impedance.

It is also advisable to connect a ceramic capacitor of approximately 0.1 μ F as a bypass capacitor between V_{CC} and V_{SS} pins near this device.

- Mode Pin (MOD)

Connect the mode pin directly to V_{CC} or V_{SS} .

To prevent the device unintentionally entering test mode due to noise, lay out the printed circuit board so as to minimize the distance from the mode pins to V_{CC} or V_{SS} and to provide a low-impedance connection.

- Analog Power Supply

Always set the same potential to AV_{CC} and V_{CC} . When $V_{CC} > AV_{CC}$, the current may flow through the AN00 to AN07 pins.

MB95110A Series

■ PROGRAMMING FLASH MEMORY MICROCONTROLLERS USING PARALLEL PROGRAMMER

• Supported Parallel Programmers and Adapters

The following table lists supported parallel programmers and adapters.

Package	Applicable adapter model	Parallel programmers
FPT-48P-M26	TEF110-118F37AP	AF9708 (Ver 02.35G or more) AF9709/B (Ver 02.35G or more) AF9723+AF9834 (Ver 02.08E or more)
FPT-52P-M01	TEF110-95F118PMC	
LCC-48P-M09	TEF100-118F41AP	

Note: For information on applicable adapter models and parallel programmers, contact the following:
Flash Support Group, Inc. TEL: +81-53-428-8380

• Sector Configuration

The individual sectors of flash memory correspond to addresses used for CPU access and programming by the parallel programmer as follows:

Flash memory	CPU address	Writer address*		
SA1 (4 Kbytes)	1000 _H	71000 _H	Lower bank	
	1FFF _H	71FFF _H		
SA2 (4 Kbytes)	2000 _H	72000 _H		
	2FFF _H	72FFF _H		
SA3 (4 Kbytes)	3000 _H	73000 _H		
	3FFF _H	73FFF _H		
SA4 (16 Kbytes)	4000 _H	74000 _H		
SA5 (16 Kbytes)	7FFF _H	77FFF _H		Upper bank
	8000 _H	78000 _H		
SA6 (4 Kbytes)	BFFF _H	7BFFF _H		
	C000 _H	7C000 _H		
SA7 (4 Kbytes)	CFFF _H	7CFFF _H		
	D000 _H	7D000 _H		
SA8 (4 Kbytes)	DFFF _H	7DFFF _H		
	E000 _H	7E000 _H		
SA9 (4 Kbytes)	EFFF _H	7EFFF _H		
	F000 _H	7F000 _H		
	FFF _H	7FFF _H		

*: Programmer addresses are equivalent to CPU addresses, used when the parallel programmer programs data into flash memory.
These programmer addresses are used for the parallel programmer to program or erase data in flash memory.

- **Programming Method**

- 1) Set the type code of the parallel programmer to "17226".
- 2) Load program data to programmer addresses 71000_H to 7FFFF_H.
- 3) Programmed by parallel programmer.

MB95110A Series

■ BLOCK DIAGRAM

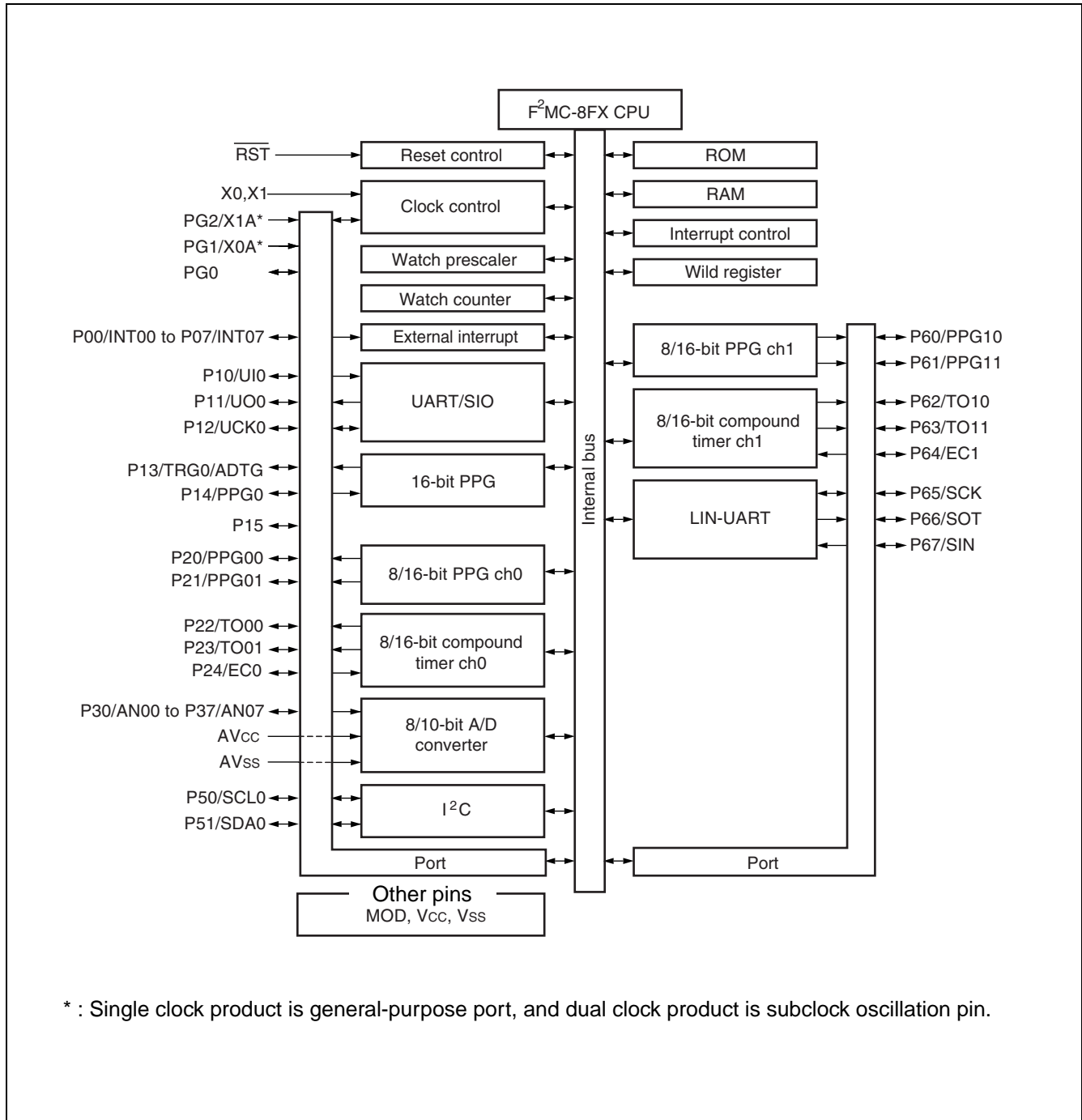

■ CPU CORE

1. Memory space

Memory space of the MB95110A series is 64 Kbytes and consists of I/O area, data area, and program area. The memory space includes special-purpose areas such as the general-purpose registers and vector table. Memory map of the MB95110A series shown in below.

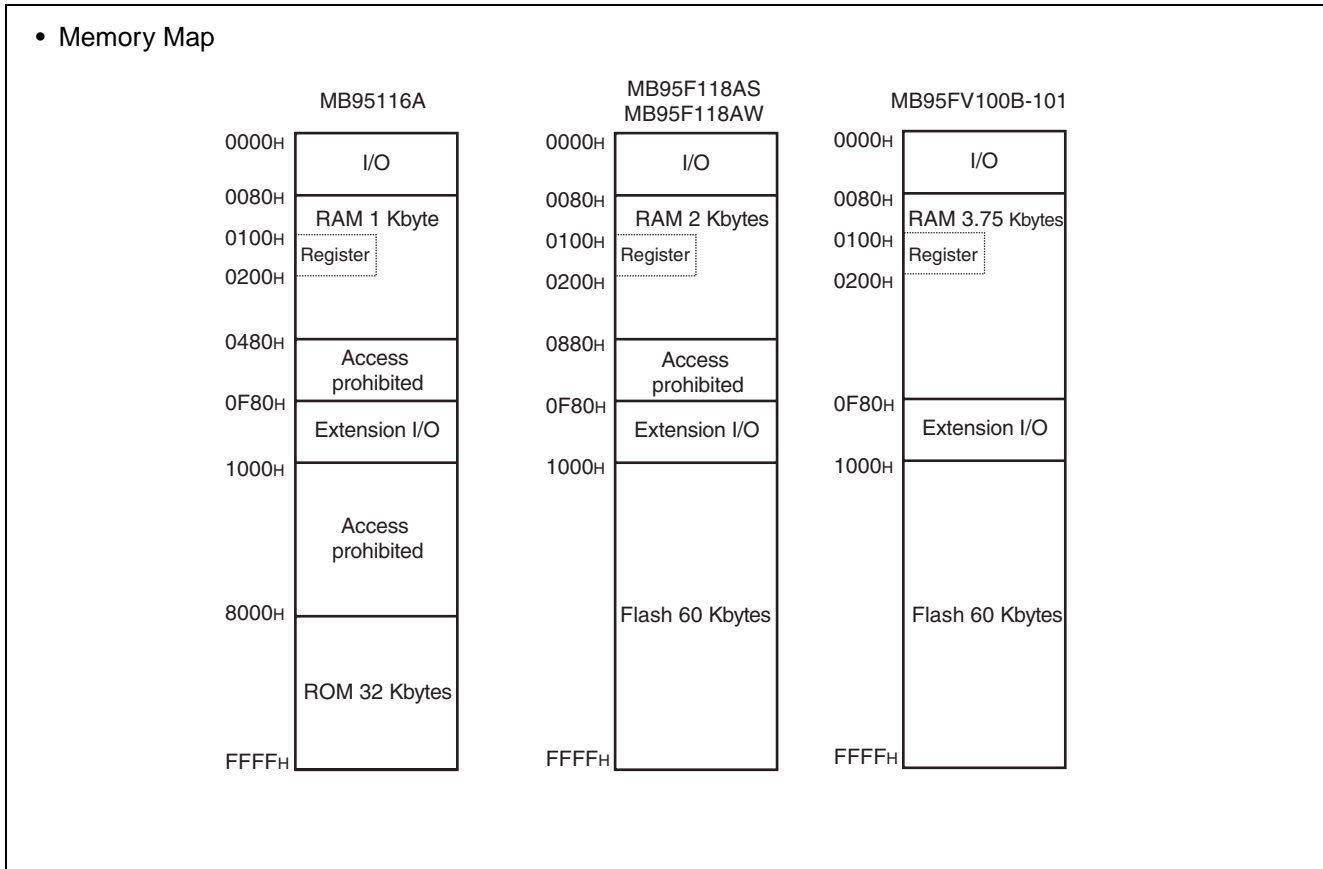

MB95110A Series

2. Register

The MB95110A series has two types of registers; dedicated registers in the CPU and general-purpose registers in the memory. The dedicated registers are as follows:

- Program counter (PC) : A 16-bit register to indicate locations where instructions are stored.
- Accumulator (A) : A 16-bit register for temporary storage of arithmetic operations. In the case of an 8-bit data processing instruction, the lower one byte is used.
- Temporary accumulator (T) : A 16-bit register which performs arithmetic operations with the accumulator. In the case of an 8-bit data processing instruction, the lower one byte is used.
- Index register (IX) : A 16-bit register for index modification
- Extra pointer (EP) : A 16-bit pointer to point to a memory address.
- Stack pointer (SP) : A 16-bit register to indicate a stack area.
- Program status (PS) : A 16-bit register for storing a register bank pointer, a direct bank pointer, and a condition code register

16-bit		Initial Value
PC	: Program counter	FFFD _H
A	: Accumulator	0000 _H
T	: Temporary accumulator	0000 _H
IX	: Index register	0000 _H
EP	: Extra pointer	0000 _H
SP	: Stack pointer	0000 _H
PS	: Program status	0030 _H

The PS can further be divided into higher 8 bits for use as a register bank pointer (RP) and a direct bank pointer (DP) and the lower 8 bits for use as a condition code register (CCR). (Refer to the diagram below.)

- Structure of the program status

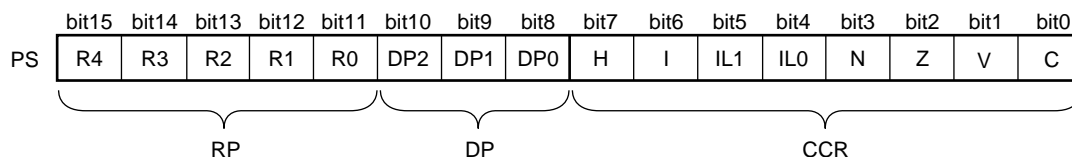

The RP indicates the address of the register bank currently being used. The relationship between the content of RP and the real address conforms to the conversion rule illustrated below:

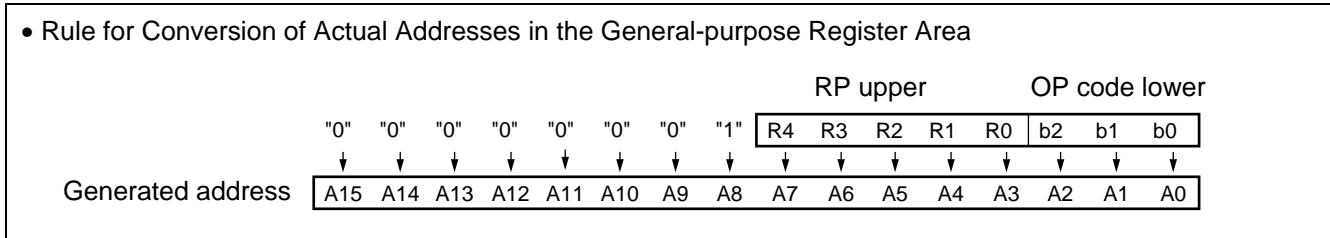

The DP specifies the area for mapping instructions (16 different instructions such as MOV A, dir) using direct addresses to 0080H to 00FFH.

Direct bank pointer (DP2 to DP0)	Specified address area	Mapping area
XXX _B (no effect to mapping)	0000 _H to 007F _H	0000 _H to 007F _H (without mapping)
000 _B (initial value)	0080 _H to 00FF _H	0080 _H to 00FF _H (without mapping)
001 _B		0100 _H to 017F _H
010 _B		0180 _H to 01FF _H
011 _B		0200 _H to 027F _H
100 _B		0280 _H to 02FF _H
101 _B		0300 _H to 037F _H
110 _B		0380 _H to 03FF _H
111 _B		0400 _H to 047F _H

The CCR consists of the bits indicating arithmetic operation results or transfer data contents and the bits that control CPU operations at interrupt.

- H flag : Set to "1" when a carry or a borrow from bit 3 to bit 4 occurs as a result of an arithmetic operation. Cleared to "0" otherwise. This flag is for decimal adjustment instructions.
- I flag : Interrupt is enabled when this flag is set to "1". Interrupt is disabled when this flag is set to "0". The flag is set to "0" when reset.
- IL1, IL0 : Indicates the level of the interrupt currently enabled. Processes an interrupt only if its request level is higher than the value indicated by this bit.

IL1	IL0	Interrupt level	Priority
0	0	0	High ↑ ↓ Low = no interruption
0	1	1	
1	0	2	
1	1	3	

- N flag : Set to "1" if the MSB is set to "1" as the result of an arithmetic operation. Cleared to "0" when the bit is set to "0".
- Z flag : Set to "1" when an arithmetic operation results in "0". Cleared to "0" otherwise.
- V flag : Set to "1" if the complement on 2 overflows as a result of an arithmetic operation. Cleared to "0" otherwise.
- C flag : Set to "1" when a carry or a borrow from bit 7 occurs as a result of an arithmetic operation. Cleared to "0" otherwise. Set to the shift-out value in the case of a shift instruction.

MB95110A Series

The following general-purpose registers are provided:

General-purpose registers: 8-bit data storage registers

The general-purpose registers are 8 bits and located in the register banks on the memory. One bank contains eight registers. Up to a total of 32 banks can be used on the MB95110A series. The bank currently in use is specified by the register bank pointer (RP), and the lower 3 bits of OP code indicates the general-purpose register 0 (R0) to general-purpose register 7 (R7).

- Register Bank Configuration

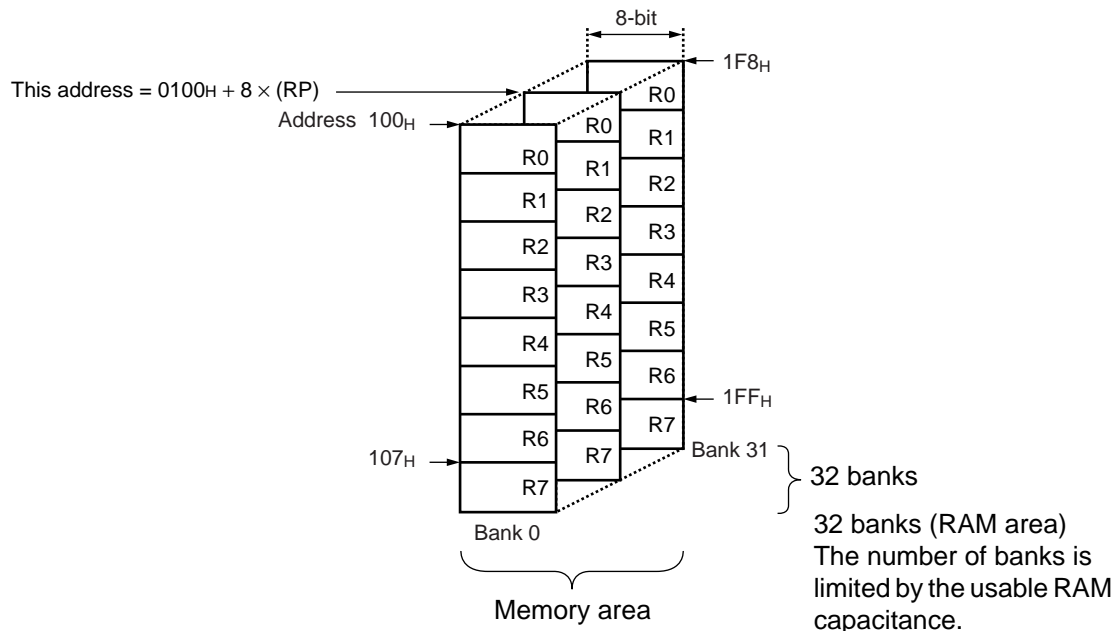

■ I/O MAP

Address	Register abbreviation	Register name	R/W	Initial value
0000 _H	PDR0	Port 0 data register	R/W	00000000 _B
0001 _H	DDR0	Port 0 direction register	R/W	00000000 _B
0002 _H	PDR1	Port 1 data register	R/W	00000000 _B
0003 _H	DDR1	Port 1 direction register	R/W	00000000 _B
0004 _H	—	(Disabled)	—	—
0005 _H	WATR	Oscillation stabilization wait time setting register	R/W	11111111 _B
0006 _H	PLLC	PLL control register	R/W	00000000 _B
0007 _H	SYCC	System clock control register	R/W	1010X011 _B
0008 _H	STBC	Standby control register	R/W	00000000 _B
0009 _H	RSRR	Reset source register	R	XXXXXXXX _B
000A _H	TBTC	Timebase timer control register	R/W	00000000 _B
000B _H	WPCR	Watch prescaler control register	R/W	00000000 _B
000C _H	WDTC	Watchdog timer control register	R/W	00000000 _B
000D _H	—	(Disabled)	—	—
000E _H	PDR2	Port 2 data register	R/W	00000000 _B
000F _H	DDR2	Port 2 direction register	R/W	00000000 _B
0010 _H	PDR3	Port 3 data register	R/W	00000000 _B
0011 _H	DDR3	Port 3 direction register	R/W	00000000 _B
0012 _H , 0013 _H	—	(Disabled)	—	—
0014 _H	PDR5	Port 5 data register	R/W	00000000 _B
0015 _H	DDR5	Port 5 direction register	R/W	00000000 _B
0016 _H	PDR6	Port 6 data register	R/W	00000000 _B
0017 _H	DDR6	Port 6 direction register	R/W	00000000 _B
0018 _H to 0029 _H	—	(Disabled)	—	—
002A _H	PDRG	Port G data register	R/W	00000000 _B
002B _H	DDRG	Port G direction register	R/W	00000000 _B
002C _H	—	(Disabled)	—	—
002D _H	PUL1	Port 1 pull-up register	R/W	00000000 _B
002E _H	PUL2	Port 2 pull-up register	R/W	00000000 _B
002F _H	PUL3	Port 3 pull-up register	R/W	00000000 _B
0030 _H to 0034 _H	—	(Disabled)	—	—

(Continued)

MB95110A Series

Address	Register abbreviation	Register name	R/W	Initial value
0035 _H	PULG	Port G pull-up register	R/W	00000000 _B
0036 _H	T01CR1	8/16-bit compound timer 01 control status register 1 ch.0	R/W	00000000 _B
0037 _H	T00CR1	8/16-bit compound timer 00 control status register 1 ch.0	R/W	00000000 _B
0038 _H	T11CR1	8/16-bit compound timer 11 control status register 1 ch.1	R/W	00000000 _B
0039 _H	T10CR1	8/16-bit compound timer 10 control status register 1 ch.1	R/W	00000000 _B
003A _H	PC01	8/16-bit PPG1 control register ch.0	R/W	00000000 _B
003B _H	PC00	8/16-bit PPG0 control register ch.0	R/W	00000000 _B
003C _H	PC11	8/16-bit PPG1 control register ch.1	R/W	00000000 _B
003D _H	PC10	8/16-bit PPG0 control register ch.1	R/W	00000000 _B
003E _H to 0041 _H	—	(Disabled)	—	—
0042 _H	PCNTH0	16-bit PPG status control register (Upper byte) ch.0	R/W	00000000 _B
0043 _H	PCNTL0	16-bit PPG status control register (Lower byte) ch.0	R/W	00000000 _B
0044 _H to 0047 _H	—	(Disabled)	—	—
0048 _H	EIC00	External interrupt circuit control register ch.0/ch.1	R/W	00000000 _B
0049 _H	EIC10	External interrupt circuit control register ch.2/ch.3	R/W	00000000 _B
004A _H	EIC20	External interrupt circuit control register ch.4/ch.5	R/W	00000000 _B
004B _H	EIC30	External interrupt circuit control register ch.6/ch.7	R/W	00000000 _B
004C _H to 004F _H	—	(Disabled)	—	—
0050 _H	SCR	LIN-UART serial control register	R/W	00000000 _B
0051 _H	SMR	LIN-UART serial mode register	R/W	00000000 _B
0052 _H	SSR	LIN-UART serial status register	R/W	00001000 _B
0053 _H	RDR/TDR	LIN-UART reception/transmission data register	R/W	00000000 _B
0054 _H	ESCR	LIN-UART extended status control register	R/W	00000100 _B
0055 _H	ECCR	LIN-UART extended communication control register	R/W	000000XX _B
0056 _H	SMC10	UART/SIO serial mode control register 1 ch.0	R/W	00000000 _B
0057 _H	SMC20	UART/SIO serial mode control register 2 ch.0	R/W	00100000 _B
0058 _H	SSR0	UART/SIO serial status register ch.0	R/W	00000001 _B
0059 _H	TDR0	UART/SIO serial output data register ch.0	R/W	00000000 _B
005A _H	RDR0	UART/SIO serial input data register ch.0	R	00000000 _B
005B _H to 005F _H	—	(Disabled)	—	—

(Continued)

MB95110A Series

Address	Register abbreviation	Register name	R/W	Initial value
0060 _H	IBCR00	I ² C bus control register 0 ch.0	R/W	00000000 _B
0061 _H	IBCR10	I ² C bus control register 1 ch.0	R/W	00000000 _B
0062 _H	IBSR0	I ² C bus status register ch.0	R	00000000 _B
0063 _H	IDDR0	I ² C data register ch.0	R/W	00000000 _B
0064 _H	IAAR0	I ² C address register ch.0	R/W	00000000 _B
0065 _H	ICCR0	I ² C clock control register ch.0	R/W	00000000 _B
0066 _H to 006B _H	—	(Disabled)	—	—
006C _H	ADC1	8/10-bit A/D converter control register 1	R/W	00000000 _B
006D _H	ADC2	8/10-bit A/D converter control register 2	R/W	00000000 _B
006E _H	ADDH	8/10-bit A/D converter data register (Upper byte)	R/W	00000000 _B
006F _H	ADDL	8/10-bit A/D converter data register (Lower byte)	R/W	00000000 _B
0070 _H	WCSR	Watch counter status register	R/W	00000000 _B
0071 _H	—	(Disabled)	—	—
0072 _H	FSR	Flash memory status register	R/W	000X0000 _B
0073 _H	SWRE0	Flash memory sector writing control register 0	R/W	00000000 _B
0074 _H	SWRE1	Flash memory sector writing control register 1	R/W	00000000 _B
0075 _H	—	(Disabled)	—	—
0076 _H	WREN	Wild register address compare enable register	R/W	00000000 _B
0077 _H	WROR	Wild register data test setting register	R/W	00000000 _B
0078 _H	—	(Mirror of register bank pointer (RP) and direct bank pointer (DP))	—	—
0079 _H	ILR0	Interrupt level setting register 0	R/W	11111111 _B
007A _H	ILR1	Interrupt level setting register 1	R/W	11111111 _B
007B _H	ILR2	Interrupt level setting register 2	R/W	11111111 _B
007C _H	ILR3	Interrupt level setting register 3	R/W	11111111 _B
007D _H	ILR4	Interrupt level setting register 4	R/W	11111111 _B
007E _H	ILR5	Interrupt level setting register 5	R/W	11111111 _B
007F _H	—	(Disabled)	—	—
0F80 _H	WRARH0	Wild register address setting register (Upper byte) ch.0	R/W	00000000 _B
0F81 _H	WRARL0	Wild register address setting register (Lower byte) ch.0	R/W	00000000 _B
0F82 _H	WRDR0	Wild register data setting register ch.0	R/W	00000000 _B
0F83 _H	WRARH1	Wild register address setting register (Upper byte) ch.1	R/W	00000000 _B
0F84 _H	WRARL1	Wild register address setting register (Lower byte) ch.1	R/W	00000000 _B
0F85 _H	WRDR1	Wild register data setting register ch.1	R/W	00000000 _B

(Continued)

MB95110A Series

Address	Register abbreviation	Register name	R/W	Initial value
0F86 _H	WRARH2	Wild register address setting register (Upper byte) ch.2	R/W	00000000 _B
0F87 _H	WRARL2	Wild register address setting register (Lower byte) ch.2	R/W	00000000 _B
0F88 _H	WRDR2	Wild register data setting register ch.2	R/W	00000000 _B
0F89 _H to 0F91 _H	—	(Disabled)	—	—
0F92 _H	T01CR0	8/16-bit compound timer 01 control status register 0 ch.0	R/W	00000000 _B
0F93 _H	T00CR0	8/16-bit compound timer 00 control status register 0 ch.0	R/W	00000000 _B
0F94 _H	T01DR	8/16-bit compound timer 01 data register ch.0	R/W	00000000 _B
0F95 _H	T00DR	8/16-bit compound timer 00 data register ch.0	R/W	00000000 _B
0F96 _H	TMCR0	8/16-bit compound timer 00/01 timer mode control register ch.0	R/W	00000000 _B
0F97 _H	T11CR0	8/16-bit compound timer 11 control status register 0 ch.1	R/W	00000000 _B
0F98 _H	T10CR0	8/16-bit compound timer 10 control status register 0 ch.1	R/W	00000000 _B
0F99 _H	T11DR	8/16-bit compound timer 11 data register ch.1	R/W	00000000 _B
0F9A _H	T10DR	8/16-bit compound timer 10 data register ch.1	R/W	00000000 _B
0F9B _H	TMCR1	8/16-bit compound timer 10/11 timer mode control register ch.1	R/W	00000000 _B
0F9C _H	PPS01	8/16-bit PPG1 cycle setting buffer register ch.0	R/W	11111111 _B
0F9D _H	PPS00	8/16-bit PPG0 cycle setting buffer register ch.0	R/W	11111111 _B
0F9E _H	PDS01	8/16-bit PPG1 duty setting buffer register ch.0	R/W	11111111 _B
0F9F _H	PDS00	8/16-bit PPG0 duty setting buffer register ch.0	R/W	11111111 _B
0FA0 _H	PPS11	8/16-bit PPG1 cycle setting buffer register ch.1	R/W	11111111 _B
0FA1 _H	PPS10	8/16-bit PPG0 cycle setting buffer register ch.1	R/W	11111111 _B
0FA2 _H	PDS11	8/16-bit PPG1 duty setting buffer register ch.1	R/W	11111111 _B
0FA3 _H	PDS10	8/16-bit PPG0 duty setting buffer register ch.1	R/W	11111111 _B
0FA4 _H	PPGS	8/16-bit PPG starting register	R/W	00000000 _B
0FA5 _H	REVC	8/16-bit PPG output inversion register	R/W	00000000 _B
0FA6 _H to 0FA9 _H	—	(Disabled)	—	—
0FAA _H	PDCRH0	16-bit PPG down counter register (Upper byte) ch.0	R	00000000 _B
0FAB _H	PDCRL0	16-bit PPG down counter register (Lower byte) ch.0	R	00000000 _B
0FAC _H	PCSRH0	16-bit PPG cycle setting buffer register (Upper byte) ch.0	R/W	11111111 _B
0FAD _H	PCSRL0	16-bit PPG cycle setting buffer register (Lower byte) ch.0	R/W	11111111 _B
0FAE _H	PDUTH0	16-bit PPG duty setting buffer register (Upper byte) ch.0	R/W	11111111 _B
0FAF _H	PDUTL0	16-bit PPG duty setting buffer register (Lower byte) ch.0	R/W	11111111 _B

(Continued)

(Continued)

Address	Register abbreviation	Register name	R/W	Initial value
0FB0 _H to 0FBB _H	—	(Disabled)	—	—
0FBC _H	BGR1	LIN-UART baud rate generator register 1	R/W	00000000 _B
0FBD _H	BGR0	LIN-UART baud rate generator register 0	R/W	00000000 _B
0FBE _H	PSSR0	UART/SIO dedicated baud rate generator prescaler selection register ch.0	R/W	00000000 _B
0FBF _H	BRSR0	UART/SIO dedicated baud rate generator baud rate setting register ch.0	R/W	00000000 _B
0FC0 _H to 0FC2 _H	—	(Disabled)	—	—
0FC3 _H	AIDRL	A/D input disable register (Lower byte)	R/W	00000000 _B
0FC4 _H to 0FE2 _H	—	(Disabled)	—	—
0FE3 _H	WCDR	Watch counter data register	R/W	00111111 _B
0FE4 _H to 0FED _H	—	(Disabled)	—	—
0FEE _H	ILSR	Input level select register	R/W	00000000 _B
0FEF _H	WICR	Interrupt pin control register	R/W	01000000 _B
0FF0 _H to 0FFF _H	—	(Disabled)	—	—

- R/W access symbols

R/W : Readable/Writable

R : Read only

W : Write only

- Initial value symbols

0 : The initial value of this bit is "0".

1 : The initial value of this bit is "1".

X : The initial value of this bit is undefined.

Note : Do not write to the " (Disabled) ". Reading the " (Disabled) " returns an undefined value.

MB95110A Series

■ INTERRUPT SOURCE TABLE

Interrupt source	Interrupt request number	Vector table address		Bit name of interrupt level setting register	Same level priority order (at simultaneous occurrence)
		Upper	Lower		
External interrupt ch.0	IRQ0	FFFA _H	FFFB _H	L00 [1 : 0]	<div style="display: flex; align-items: center; justify-content: center;"> <div style="margin-right: 10px;">High</div> <div style="flex-grow: 1; border-left: 1px solid black; position: relative;"> <div style="position: absolute; top: -10px; left: 50%; transform: translate(-50%, -50%);">↑</div> <div style="position: absolute; bottom: -10px; left: 50%; transform: translate(-50%, -50%);">↓</div> </div> <div style="margin-left: 10px;">Low</div> </div>
External interrupt ch.4					
External interrupt ch.1	IRQ1	FFF8 _H	FFF9 _H	L01 [1 : 0]	
External interrupt ch.5					
External interrupt ch.2	IRQ2	FFF6 _H	FFF7 _H	L02 [1 : 0]	
External interrupt ch.6					
External interrupt ch.3	IRQ3	FFF4 _H	FFF5 _H	L03 [1 : 0]	
External interrupt ch.7					
UART/SIO ch.0	IRQ4	FFF2 _H	FFF3 _H	L04 [1 : 0]	
8/16-bit compound timer ch.0 (Lower)	IRQ5	FFF0 _H	FFF1 _H	L05 [1 : 0]	
8/16-bit compound timer ch.0 (Upper)	IRQ6	FFEE _H	FFEF _H	L06 [1 : 0]	
LIN-UART (reception)	IRQ7	FFEC _H	FFED _H	L07 [1 : 0]	
LIN-UART (transmission)	IRQ8	FFEA _H	FFEB _H	L08 [1 : 0]	
8/16-bit PPG ch.1 (Lower)	IRQ9	FFE8 _H	FFE9 _H	L09 [1 : 0]	
8/16-bit PPG ch.1 (Upper)	IRQ10	FFE6 _H	FFE7 _H	L10 [1 : 0]	
(Unused)	IRQ11	FFE4 _H	FFE5 _H	L11 [1 : 0]	
8/16-bit PPG ch.0 (Upper)	IRQ12	FFE2 _H	FFE3 _H	L12 [1 : 0]	
8/16-bit PPG ch.0 (Lower)	IRQ13	FFE0 _H	FFE1 _H	L13 [1 : 0]	
8/16-bit compound timer ch.1 (Upper)	IRQ14	FFDE _H	FFDF _H	L14 [1 : 0]	
16-bit PPG ch.0	IRQ15	FFDC _H	FFDD _H	L15 [1 : 0]	
I ² C ch.0	IRQ16	FFDA _H	FFDB _H	L16 [1 : 0]	
(Unused)	IRQ17	FFD8 _H	FFD9 _H	L17 [1 : 0]	
8/10-bit A/D converter	IRQ18	FFD6 _H	FFD7 _H	L18 [1 : 0]	
Timebase timer	IRQ19	FFD4 _H	FFD5 _H	L19 [1 : 0]	
Watch prescaler/counter	IRQ20	FFD2 _H	FFD3 _H	L20 [1 : 0]	
(Unused)	IRQ21	FFD0 _H	FFD1 _H	L21 [1 : 0]	
8/16-bit compound timer ch.1 (Lower)	IRQ22	FFCE _H	FFCF _H	L22 [1 : 0]	
Flash memory	IRQ23	FFCC _H	FFCD _H	L23 [1 : 0]	

■ ELECTRICAL CHARACTERISTICS

1. Absolute Maximum Ratings

Parameter	Symbol	Rating		Unit	Remarks
		Min	Max		
Power supply voltage*1	V _{CC} , AV _{CC}	V _{SS} – 0.3	V _{SS} + 4.0	V	*2
Input voltage*1	V _{I1}	V _{SS} – 0.3	V _{SS} + 4.0	V	Other than P50, P51*3
	V _{I2}	V _{SS} – 0.3	V _{SS} + 6.0		P50, P51
Output voltage*1	V _O	V _{SS} – 0.3	V _{SS} + 4.0	V	*3
Maximum clamp current	I _{CLAMP}	– 2.0	+ 2.0	mA	Applicable to pins*4
Total maximum clamp current	Σ I _{CLAMP}	—	20	mA	Applicable to pins*4
“L” level maximum output current	I _{OL1}	—	15	mA	Other than P00 to P07
	I _{OL2}		15		P00 to P07
“L” level average current	I _{OLAV1}	—	4	mA	Other than P00 to P07 Average output current = operating current × operating ratio (1 pin)
	I _{OLAV2}		12		P00 to P07 Average output current = operating current × operating ratio (1 pin)
“L” level total maximum output current	ΣI _{OL}	—	100	mA	
“L” level total average output current	ΣI _{OLAV}	—	50	mA	Total average output current = operating current × operating ratio (total of pins)
“H” level maximum output current	I _{OH1}	—	– 15	mA	Other than P00 to P07
	I _{OH2}		– 15		P00 to P07
“H” level average current	I _{OHAV1}	—	– 4	mA	Other than P00 to P07 Average output current = operating current × operating ratio (1 pin)
	I _{OHAV2}		– 8		P00 to P07 Average output current = operating current × operating ratio (1 pin)
“H” level total maximum output current	ΣI _{OH}	—	– 100	mA	
“H” level total average output current	ΣI _{OHAV}	—	– 50	mA	Total average output current = operating current × operating ratio (total of pins)
Power consumption	P _d	—	320	mW	
Operating temperature	T _A	– 40	+ 85	°C	
Storage temperature	T _{stg}	– 55	+ 150	°C	

(Continued)

MB95110A Series

(Continued)

*1 : The parameter is based on $AV_{CC} = V_{SS} = 0.0 \text{ V}$.

*2 : Apply equal potential to AV_{CC} and V_{CC} .

*3 : V_{I1} and V_O should not exceed $V_{CC} + 0.3 \text{ V}$. V_{I1} must not exceed the rating voltage. However, if the maximum current to/from an input is limited by some means with external components, the I_{CLAMP} rating supersedes the V_{I1} rating.

- *4 :
- Applicable to pins : P00 to P07, P10 to P15, P20 to P24, P30 to P37, PG0
 - Use within recommended operating conditions.
 - Use at DC voltage (current).
 - +B signal is an input signal that exceeds V_{CC} voltage. The + B signal should always be applied a limiting resistance placed between the + B signal and the microcontroller.
 - The value of the limiting resistance should be set so that when the + B signal is applied the input current to the microcontroller pin does not exceed rated values, either instantaneously or for prolonged periods.
 - Note that when the microcontroller drive current is low, such as in the power saving modes, the +B input potential may pass through the protective diode and increase the potential at the VCC pin, and this may affect other devices.
 - Note that if the + B signal is inputted when the microcontroller power supply is off (not fixed at 0 V), the power supply is provided from the pins, so that incomplete operation may result.
 - Note that if the + B input is applied during power-on, the power supply is provided from the pins and the resulting power supply voltage may not be sufficient to operate the power-on reset.
 - Care must be taken not to leave the + B input pin open.
 - Sample recommended circuits :

• Input/Output Equivalent Circuits

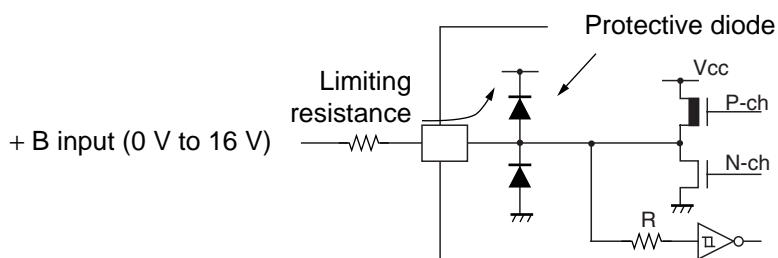

WARNING: Semiconductor devices can be permanently damaged by application of stress (voltage, current, temperature, etc.) in excess of absolute maximum ratings. Do not exceed these ratings.

MB95110A Series

2. Recommended Operating Conditions

($AV_{SS} = V_{SS} = 0.0\text{ V}$)

Parameter	Symbol	Pin name	Conditions	Value			Unit	Remarks
				Min	Typ	Max		
Power supply voltage	V_{CC} , AV_{CC}	—	—	1.8*1	—	3.3	V	At normal operating, Flash memory product, $T_A = -10\text{ °C to }+85\text{ °C}$
				1.8*1	—	3.6		At normal operating, MASK ROM product, $T_A = -10\text{ °C to }+85\text{ °C}$
				2.0*1	—	3.3		At normal operating, Flash memory product, $T_A = -40\text{ °C to }+85\text{ °C}$
				2.0*1	—	3.6		At normal operating, MASK ROM product, $T_A = -40\text{ °C to }+85\text{ °C}$
				2.6	—	3.6		MB95FV100B-101, $T_A = +5\text{ °C to }+35\text{ °C}$
				1.5	—	3.3		Retain status of stop mode operation, Flash memory product
				1.5	—	3.6		Retain status of stop mode operation, MASK ROM product
"H" level input voltage	V_{IH1}	P10, P67	*2	0.7 V_{CC}	—	$V_{CC} + 0.3$	V	At selecting of CMOS input level (hysteresis input)
	V_{IH2}	P50, P51	*2	0.7 V_{CC}	—	$V_{SS} + 5.5$	V	At selecting of CMOS input level (hysteresis input)
	V_{IHS1}	P00 to P07, P10 to P15, P20 to P24, P30 to P37, P60 to P67, PG0, PG1*2, PG2*2	*2	0.8 V_{CC}	—	$V_{CC} + 0.3$	V	Hysteresis input
	V_{IHS2}	P50, P51	*2	0.8 V_{CC}	—	$V_{SS} + 5.5$	V	Hysteresis input
	V_{IHM}	\overline{RST} , MOD	—	—	0.7 V_{CC}	—	$V_{CC} + 0.3$	V
—			—	0.8 V_{CC}	—	$V_{CC} + 0.3$	V	Hysteresis input (MASK ROM product)

(Continued)

MB95110A Series

(Continued)

Parameter	Symbol	Pin name	Conditions	Value			Unit	Remarks
				Min	Typ	Max		
“L” level input voltage	V_{IL}	P10, P50, P51, P67	*2	$V_{SS} - 0.3$	—	$0.3 V_{CC}$	V	At selecting of CMOS input level (hysteresis input)
	V_{ILS}	P00 to P07, P10 to P15, P20 to P24, P30 to P37, P50, P51, P60 to P67, PG0, PG1*2, PG2*2	*2	$V_{SS} - 0.3$	—	$0.2 V_{CC}$	V	Hysteresis input
	V_{ILM}	\overline{RST} , MOD	—	$V_{SS} - 0.3$	—	$0.3 V_{CC}$	V	CMOS input (Flash memory product)
			—	$V_{SS} - 0.3$	—	$0.2 V_{CC}$	V	Hysteresis input (MASK ROM product)
Operating temperature	T_A	—	—	- 40	—	+ 85	°C	

*1 : The values vary with the operating frequency.

*2 : P10, P50, P51, and P67 can switch the input level to either the “CMOS input level” or “hysteresis input level”. The switching of the input level can be set by the input level selection register (ILSR).

WARNING: The recommended operating conditions are required in order to ensure the normal operation of the semiconductor device. All of the device’s electrical characteristics are warranted when the device is operated within these ranges.

Always use semiconductor devices within their recommended operating condition ranges. Operation outside these ranges may adversely affect reliability and could result in device failure.

No warranty is made with respect to uses, operating conditions, or combinations not represented on the data sheet. Users considering application outside the listed conditions are advised to contact their FUJITSU representatives beforehand.

MB95110A Series

3. DC Characteristics

($V_{CC} = AV_{CC} = 3.3\text{ V}$, $AV_{SS} = V_{SS} = 0.0\text{ V}$, $T_A = -40\text{ }^\circ\text{C}$ to $+85\text{ }^\circ\text{C}$)

Parameter	Symbol	Pin name	Conditions	Value			Unit	Remarks
				Min	Typ	Max		
“H” level output voltage	V_{OH1}	Output pin other than P00 to P07	$I_{OH} = -4.0\text{ mA}$	2.4	—	—	V	MB95FV100B-101 a conditional : $I_{OH} = -2.0\text{ mA}$
	V_{OH2}	P00 to P07	$I_{OH} = -8.0\text{ mA}$	2.4	—	—	V	MB95FV100B-101 a conditional : $I_{OH} = -5.0\text{ mA}$
“L” level output voltage	V_{OL1}	Output pin other than P00 to P07	$I_{OL} = 4.0\text{ mA}$	—	—	0.4	V	MB95FV100B-101 a conditional : $I_{OL} = 3.0\text{ mA}$
	V_{OL2}	P00 to P07	$I_{OL} = 12\text{ mA}$	—	—	0.4	V	MB95FV100B-101 a conditional : $I_{OL} = 8.0\text{ mA}$
Open drain output application voltage	V_D	P50, P51	—	$V_{SS} - 0.3$	—	$V_{SS} + 5.5$	V	
Input leakage current (Hi-Z output leakage current)	I_{LI}	Port other than P50, P51	$0.0\text{ V} < V_I < V_{CC}$	-5	—	+5	μA	When no pull-up prohibition setting
Open drain output leakage current	I_{LIOD}	P50, P51	$0.0\text{ V} < V_I < V_{SS} + 5.5\text{ V}$	—	—	+5	μA	
Pull-up resistor	R_{PULL}	P10 to P15, P20 to P24, P30 to P37, PG0, PG1*1, PG2*1	$V_I = 0.0\text{ V}$	25	50	100	k Ω	When pull-up permission setting
Pull-down resistor	R_{MOD}	MOD	$V_I = V_{CC}$	50	100	200	k Ω	MASK ROM product only
Power supply current*2	I_{CC}	V_{CC} (external clock operation)	$F_{CH} = 20\text{ MHz}$ $F_{MP} = 10\text{ MHz}$ Main clock mode (divided by 2)	—	11	14	mA	Flash memory product
				—	7.3	10	mA	MASK ROM product
				—	30	35	mA	Flash memory product (at FLASH writing and erasing)
	I_{CCS}		$F_{CH} = 20\text{ MHz}$ $F_{MP} = 10\text{ MHz}$ Main Sleep mode (divided by 2)	—	4.5	6	mA	

(Continued)

MB95110A Series

(Continued)

($V_{CC} = AV_{CC} = 3.3\text{ V}$, $AV_{SS} = V_{SS} = 0.0\text{ V}$, $T_A = -40\text{ }^\circ\text{C}$ to $+85\text{ }^\circ\text{C}$)

Parameter	Symbol	Pin name	Conditions	Value			Unit	Remarks
				Min	Typ	Max		
Power supply current* ²	I _{CCL}	V _{CC} (external clock operation)	F _{CL} = 32 kHz F _{MPL} = 16 kHz Subclock mode (divided by 2), T _A = +25 °C	—	25	35	μA	
	I _{CCLS}		F _{CL} = 32 kHz F _{MPL} = 16 kHz Sub sleep mode (divided by 2), T _A = +25 °C	—	7	15	μA	
	I _{CCT}		F _{CL} = 32 kHz Watch mode	—	2	10	μA	Flash memory product
			Main stop mode T _A = +25 °C	—	1	5	μA	MASK ROM product
	I _{CCMPLL}		F _{CH} = 4 MHz F _{MP} = 10 MHz Main PLL mode (multiplied by 2.5)	—	10	14	mA	Flash memory product
				—	6.7	10	mA	MASK ROM product
	I _{CCSPLL}		F _{CL} = 32 kHz F _{MPL} = 128 kHz Sub PLL mode (multiplied by 4), T _A = +25 °C	—	190	250	μA	
	I _{CTS}		F _{CH} = 10 MHz Timebase timer mode T _A = +25 °C	—	0.4	0.5	mA	
	I _{CCH}	Sub stop mode T _A = +25 °C	—	1	5	μA		
	I _A	AV _{CC}	F _{CH} = 10 MHz At A/D converting	—	1.3	2.2	mA	
I _{AH}	F _{CH} = 10 MHz At A/D converting stop T _A = +25 °C		—	1	5	μA		
Input capacitance	C _{IN}	Other than AV _{CC} , AV _{SS} , V _{CC} , and V _{SS}	f = 1 MHz	—	5	15	pF	

*1 : Single clock products only

*2 : The power-supply current is determined by the external clock.

- Refer to “4. AC characteristics (1) Clock Timing” for F_{CH} and F_{CL}.
- Refer to “4. AC characteristics (2) Source Clock/Machine Clock” for f_{MP} and f_{MPL}.

4. AC Characteristics

(1) Clock Timing

(V_{CC} = 3.3 V, AV_{SS} = V_{SS} = 0.0 V, T_A = -40 °C to +85 °C)

Parameter	Symbol	Pin	Conditions	Value			Unit	Remarks
				Min	Typ	Max		
Clock frequency	F _{CH}	X0, X1	—	1	—	10	MHz	When using Main oscillation circuit
				1	—	20	MHz	When using external clock
				3	—	10	MHz	Main PLL multiplied by 1
				3	—	5	MHz	Main PLL multiplied by 2
				3	—	4	MHz	Main PLL multiplied by 2.5
	F _{CL}	X0A, X1A		—	32.768	—	kHz	When using Sub oscillation circuit
Clock cycle time	t _{H CYL}	X0, X1	100	—	1000	ns	When using Main oscillation circuit	
			50	—	1000	ns	When using Sub oscillation circuit	
	t _{L CYL}	X0A, X1A	—	30.5	—	μs	Subclock	
Input clock pulse width	t _{WH1} t _{WL1}	X0	10	—	—	ns	When using external clock Duty ratio is about 30% to 70%.	
	t _{WH2} t _{WL2}	X0A	—	15.2	—	μs		
Input clock rise time and fall time	t _{CR} t _{CF}	X0, X0A	—	—	5	ns	When using external clock	

MB95110A Series

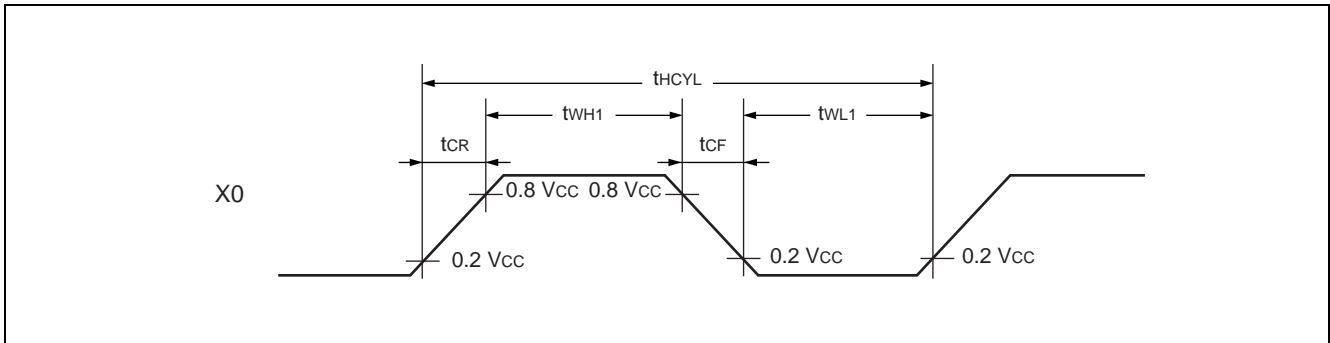

• Figure of Main Clock Input Port External Connection

When using a crystal or ceramic oscillator

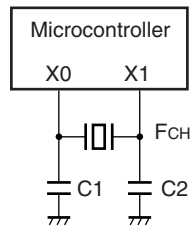

When using external clock

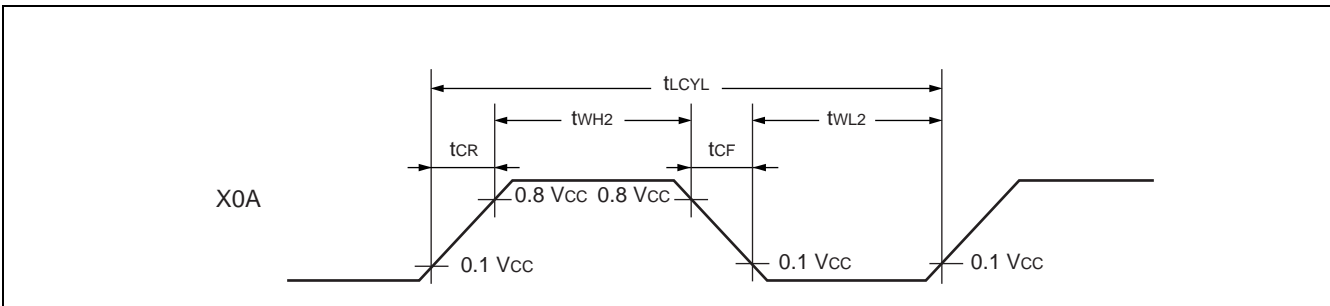
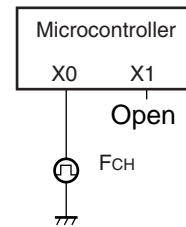

• Figure of Subclock Input Port External Connection

When using a crystal or ceramic oscillator

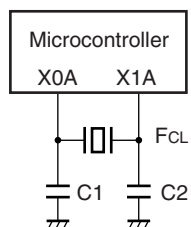

When using external clock

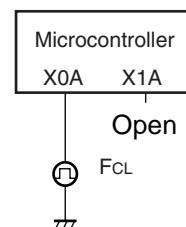

(2) Source Clock/Machine Clock

(V_{CC} = 3.3 V, AV_{SS} = V_{SS} = 0.0 V, T_A = -40 °C to +85 °C)

Parameter	Sym- bol	Pin name	Value			Unit	Remarks
			Min	Typ	Max		
Source clock*1 (Clock before setting division)	t _{SCLK}	—	100	—	2000	ns	When using Main clock Min : F _{CH} = 10 MHz, PLL multiplied by 1 Max : F _{CH} = 1 MHz, divided by 2
			7.6	—	61.0	μs	When using Subclock Min : F _{CL} = 32 kHz, PLL multiplied by 4 Max : F _{CL} = 32 kHz, divided by 2
Source clock frequency	F _{SP}	—	0.5	—	10.0	MHz	When using Main clock
	F _{SPL}	—	16.384	—	131.072	kHz	When using Subclock
Machine clock*2 (Minimum instruction execution time)	t _{MCLK}	—	100	—	32000	ns	When using Main clock Min : F _{SP} = 10 MHz, no division Max : F _{SP} = 0.5 MHz, divided by 16
			7.6	—	976.5	μs	When using Subclock Min : F _{SPL} = 131 kHz, no division Max : F _{SPL} = 16 kHz, divided by 16
Machine clock frequency	F _{MP}	—	0.031	—	10.000	MHz	When using Main clock
	F _{MPL}	—	1.024	—	131.072	kHz	When using Subclock

*1 : Clock before setting division due to machine clock division ratio selection bit (SYCC : DIV1 and DIV0) . This source clock is divided by the machine clock division ratio selection bit (SYCC : DIV1 and DIV0) , and it becomes the machine clock. Further, the source clock can be selected as follow.

- Main clock divided by 2
- PLL multiplication of main clock (select from 1, 2, 2.5 multiplication)
- Subclock divided by 2
- PLL multiplication of subclock (select from 2, 3, 4 multiplication)

*2 : Operation clock of the microcontroller. Machine clock can be selected as follow.

- Source clock (no division)
- Source clock divided by 4
- Source clock divided by 8
- Source clock divided by 16

MB95110A Series

• Outline of clock generation block

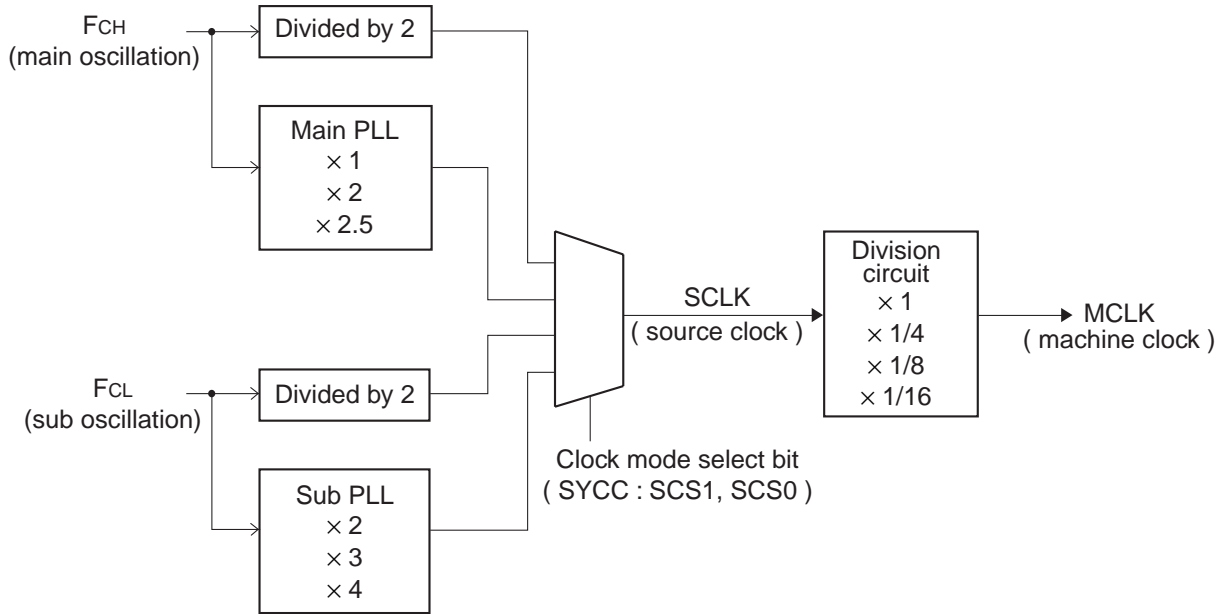

- Operating voltage - Operating frequency (When $T_A = -10\text{ }^\circ\text{C}$ to $+85\text{ }^\circ\text{C}$)
 - MB95116A

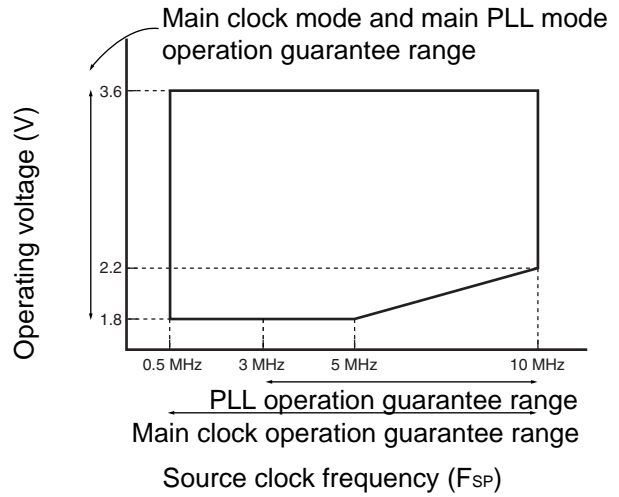
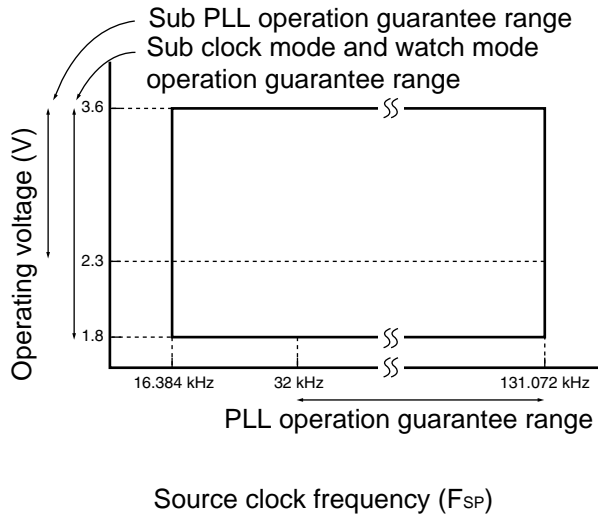

- MB95F118AS, MB95F118AW

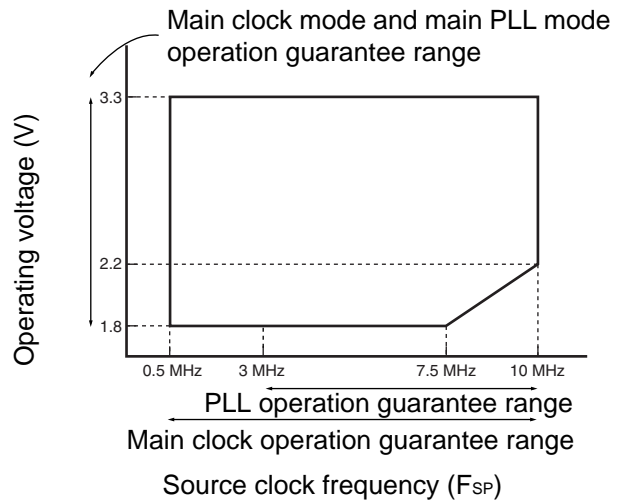
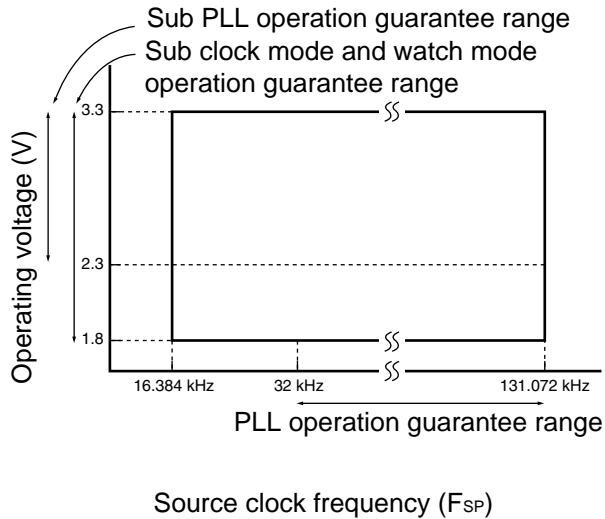

MB95110A Series

- Operating voltage - Operating frequency (When $T_A = -40\text{ }^\circ\text{C}$ to $+85\text{ }^\circ\text{C}$)
 - MB95116A

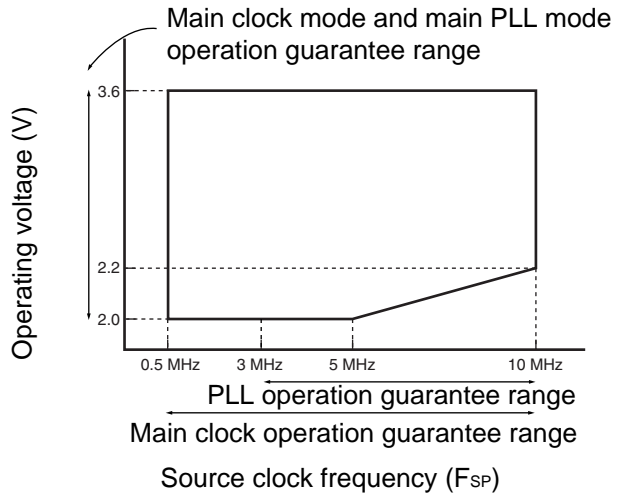
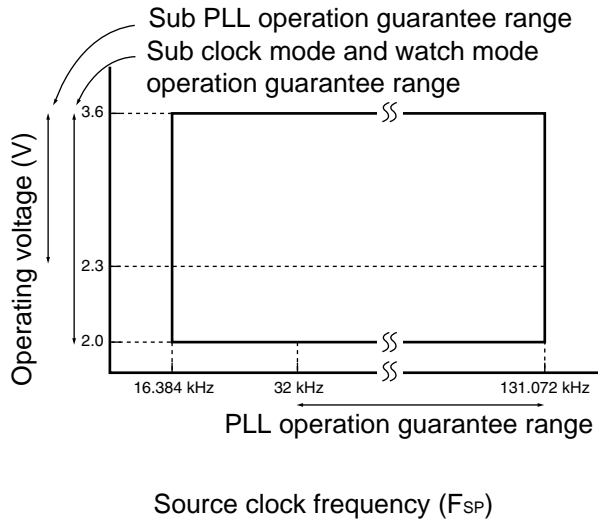

- MB95F118AS, MB95F118AW

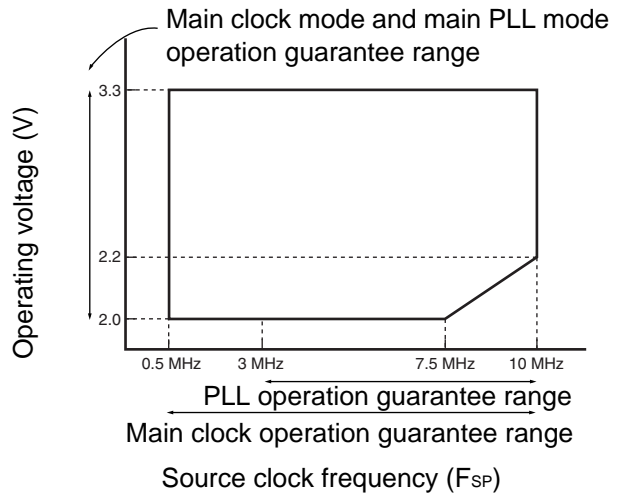
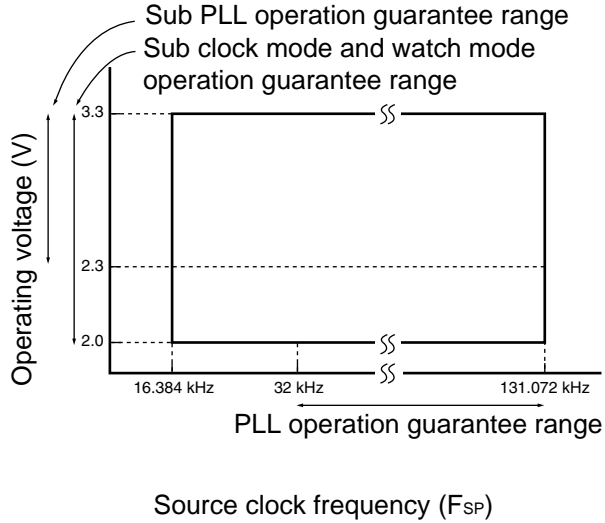

- Operating voltage - Operating frequency (When $T_A = +5\text{ }^\circ\text{C}$ to $+35\text{ }^\circ\text{C}$)
 - MB95FV100B-101

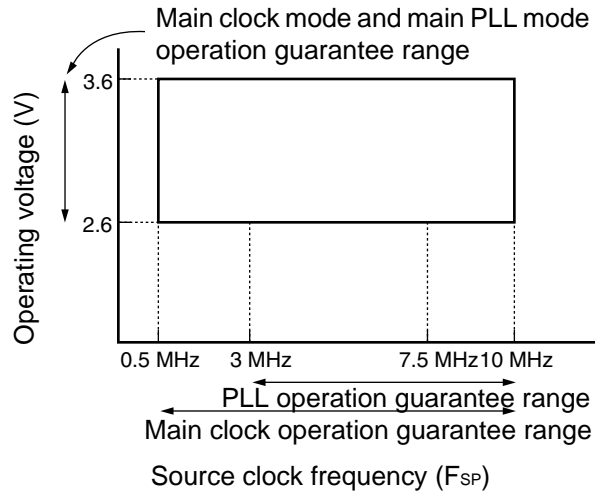
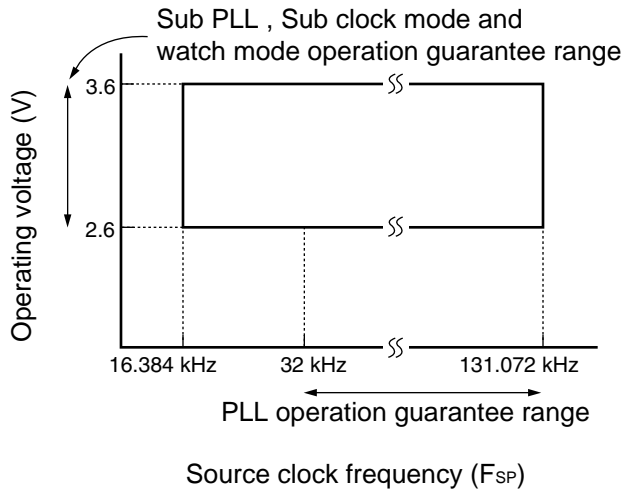

- Main PLL operation frequency

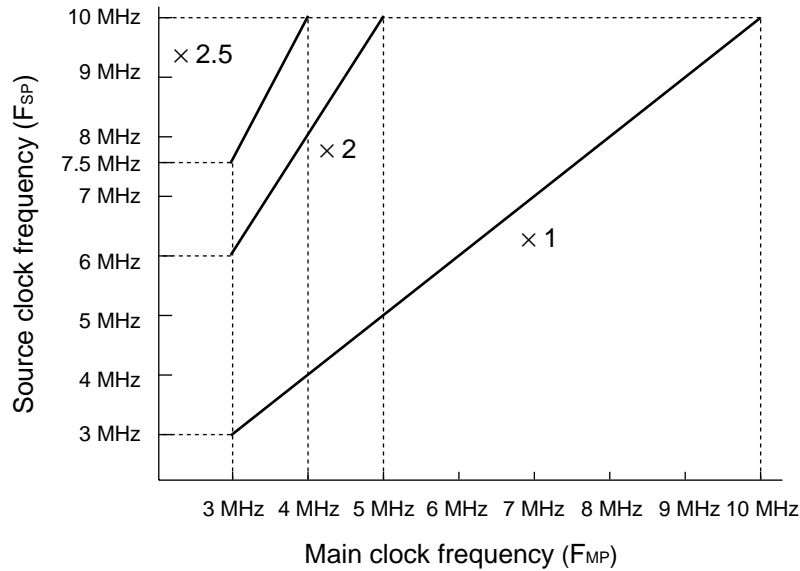

MB95110A Series

(3) External Reset

($V_{CC} = 3.3\text{ V}$, $A_{VSS} = V_{SS} = 0.0\text{ V}$, $T_A = -40\text{ }^\circ\text{C}$ to $+85\text{ }^\circ\text{C}$)

Parameter	Symbol	Value		Unit	Remarks
		Min	Max		
$\overline{\text{RST}}$ "L" level pulse width	t_{RSTL}	$2 t_{\text{MCLK}}^{*1}$	—	ns	At normal operating
		Oscillation time of oscillator ^{*2} $+ 2 t_{\text{MCLK}}^{*1}$	—	ns	At stop mode, subclock mode, Sub sleep mode, and watch mode

*1 : Refer to "(2) Source Clock/Machine Clock" for t_{MCLK} .

*2 : Oscillation time of oscillator is the time that the amplitude reaches 90 %. In the crystal oscillator, the oscillation time is between several ms and tens of ms. In ceramic oscillators, the oscillation time is between hundreds of μs and several ms. In the external clock, the oscillation time is 0 ms.

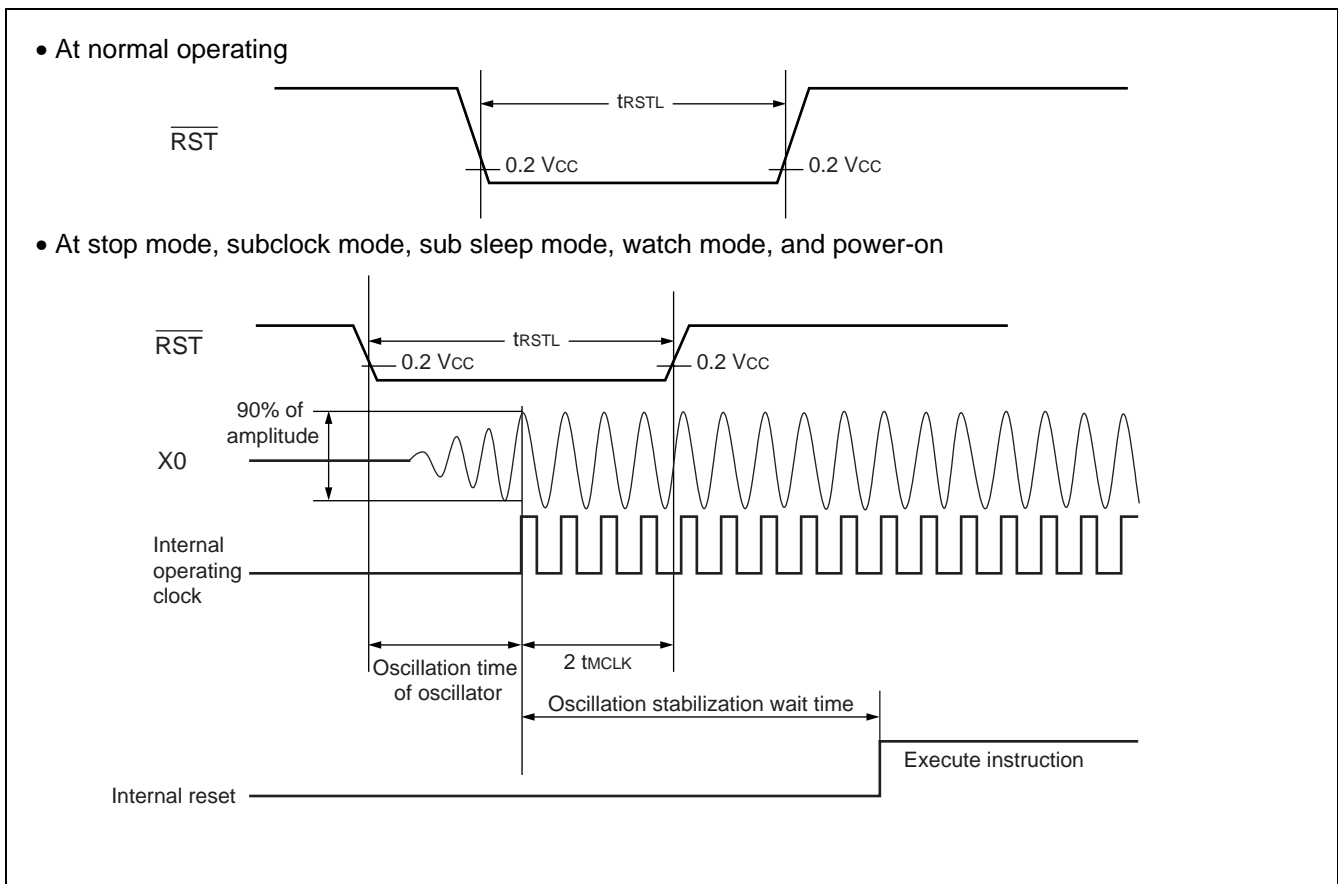

(4) Power-on Reset

($A_{VSS} = V_{SS} = 0.0 \text{ V}$, $T_A = -40 \text{ }^\circ\text{C}$ to $+85 \text{ }^\circ\text{C}$)

Parameter	Symbol	Conditions	Value		Unit	Remarks
			Min	Max		
Power supply rising time	t_R	—	—	36	ms	
Power supply cutoff time	t_{OFF}	—	1	—	ms	Waiting time until power-on

Note : The power supply must be turned on within the selected oscillation stabilization time.

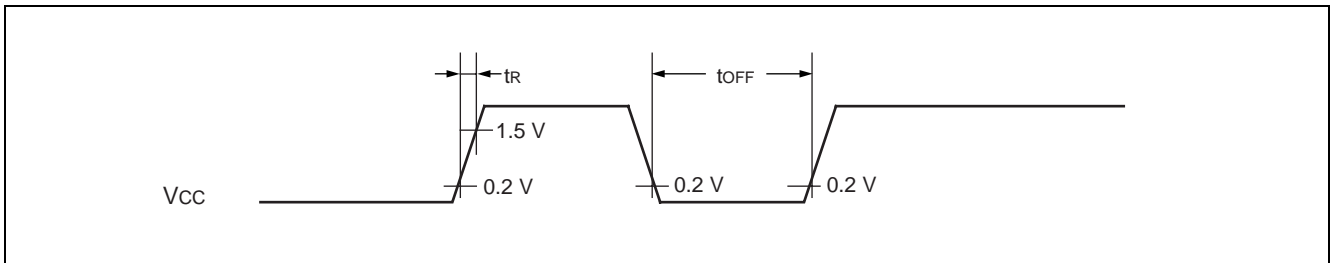

Note : Sudden change of power supply voltage may activate the power-on reset function. When changing power supply voltages during operation, set the slope of rising within 20 mV/ms as shown below.

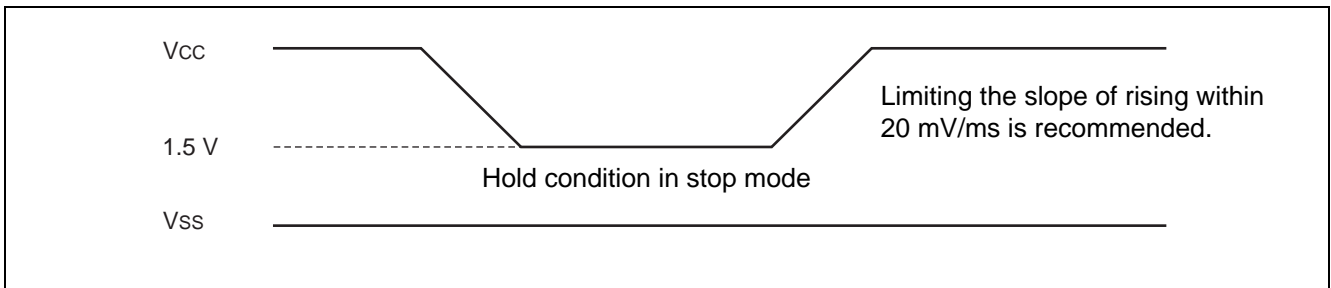

MB95110A Series

(5) Peripheral Input Timing

($V_{CC} = 3.3\text{ V}$, $A/V_{SS} = V_{SS} = 0.0\text{ V}$, $T_A = -40\text{ }^\circ\text{C}$ to $+85\text{ }^\circ\text{C}$)

Parameter	Symbol	Pin name	Value		Unit	Remarks
			Min	Max		
Peripheral input "H" pulse width	t_{ILIH}	INT00 to INT07, EC0, EC1, TRG0/ADTG	$2 t_{MCLK}^*$	—	ns	
Peripheral input "L" pulse width	t_{IHIL}		$2 t_{MCLK}^*$	—	ns	

* : Refer to "(2) Source Clock/Machine Clock" for t_{MCLK} .

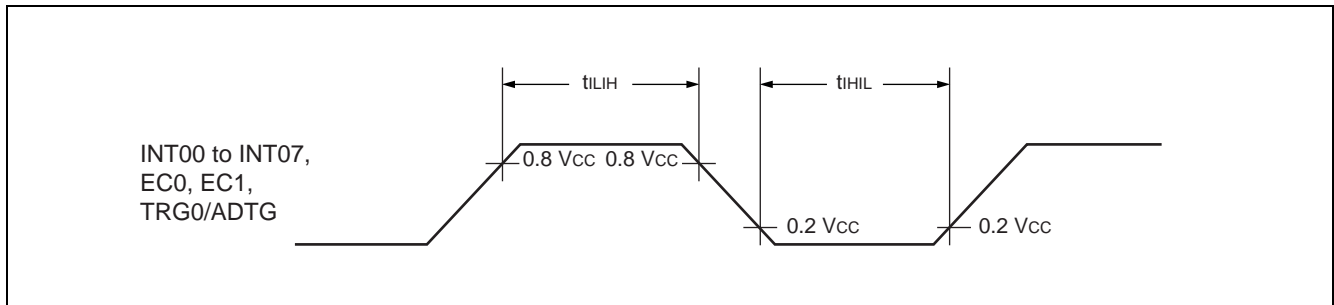

(6) UART/SIO, Serial I/O Timing

(V_{CC} = 3.3 V, AV_{SS} = V_{SS} = 0.0 V, T_A = -40 °C to +85 °C)

Parameter	Symbol	Pin name	Conditions	Value		Unit	Remarks
				Min	Max		
Serial clock cycle time	t _{SCYC}	UCK0	Internal clock operation output pin : C _L = 80 pF + 1 TTL.	4 t _{MCLK} *	—	ns	
UCK ↓ → UO time	t _{SLOV}	UCK0, UO0		- 190	+ 190	ns	
Valid UI → UCK ↑	t _{IVSH}	UCK0, UI0		2 t _{MCLK} *	—	ns	
UCK ↑ → valid UI hold time	t _{SHIX}	UCK0, UI0		2 t _{MCLK} *	—	ns	
Serial clock "H" pulse width	t _{SHSL}	UCK0	External clock operation output pin : C _L = 80 pF + 1 TTL.	4 t _{MCLK} *	—	ns	
Serial clock "L" pulse width	t _{SLSH}	UCK0		4 t _{MCLK} *	—	ns	
UCK ↓ → UO time	t _{SLOV}	UCK0, UO0		—	190	ns	
Valid UI → UCK ↑	t _{IVSH}	UCK0, UI0		2 t _{MCLK} *	—	ns	
UCK ↑ → valid UI hold time	t _{SHIX}	UCK0, UI0	2 t _{MCLK} *	—	ns		

* : Refer to "(2) Source Clock/Machine Clock" for t_{MCLK}.

• Internal shift clock mode

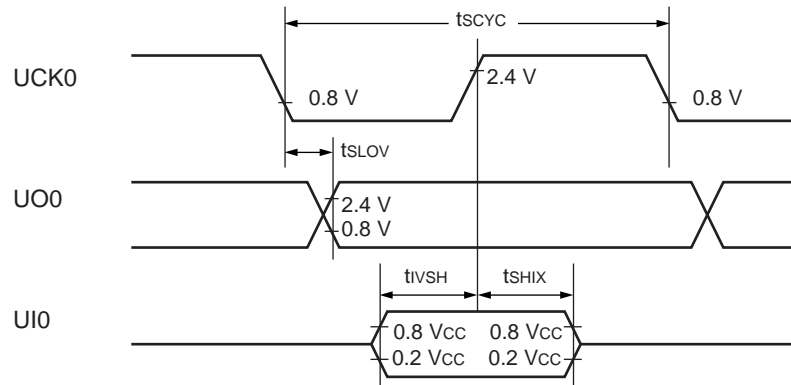

• External shift clock mode

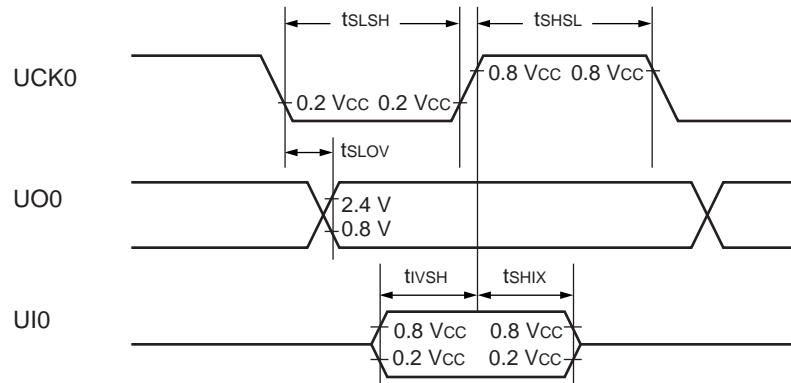

MB95110A Series

(7) LIN-UART Timing

Sampling at the rising edge of sampling clock*1 and prohibited serial clock delay*2
 (ESCR register : SCES bit = 0, ECCR register : SCDE bit = 0)

(V_{CC} = 3.3 V, AV_{SS} = V_{SS} = 0.0 V, T_A = -40 °C to + 85 °C)

Parameter	Sym- bol	Pin name	Conditions	Value		Unit
				Min	Max	
Serial clock cycle time	t _{SCYC}	SCK	Internal clock operation output pin : C _L = 80 pF + 1 TTL	5 t _{MCLK} *3	—	ns
SCK ↑→ SOT delay time	t _{SLOVI}	SCK, SOT		- 95	+ 95	ns
Valid SIN→SCK↑	t _{IVSHI}	SCK, SIN		t _{MCLK} *3 + 190	—	ns
SCK↑→ valid SIN hold time	t _{SHIXI}	SCK, SIN		0	—	ns
Serial clock "L" pulse width	t _{SLSH}	SCK	External clock operation output pin : C _L = 80 pF + 1 TTL	3 t _{MCLK} *3 - t _r	—	ns
Serial clock "H" pulse width	t _{SHSL}	SCK		t _{MCLK} *3 + 95	—	ns
SCK ↓→SOT delay time	t _{SLOVE}	SCK, SOT		—	2 t _{MCLK} *3 + 95	ns
Valid SIN→SCK↑	t _{IVSHE}	SCK, SIN		190	—	ns
SCK↑→ valid SIN hold time	t _{SHIXE}	SCK, SIN		t _{MCLK} *3 + 95	—	ns
SCK fall time	t _f	SCK		—	10	ns
SCK rise time	t _r	SCK		—	10	ns

*1 : Provide switch function whether sampling of reception data is performed at rising edge or falling edge of the serial clock.

*2 : Serial clock delay function is used to delay half clock for the output signal of serial clock.

*3 : Refer to "(2) Source Clock/Machine Clock" for t_{MCLK}.

- Internal shift clock mode

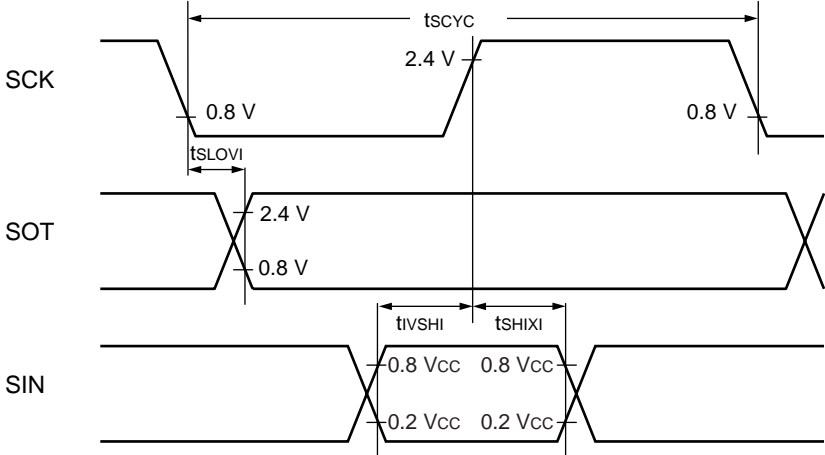

- External shift clock mode

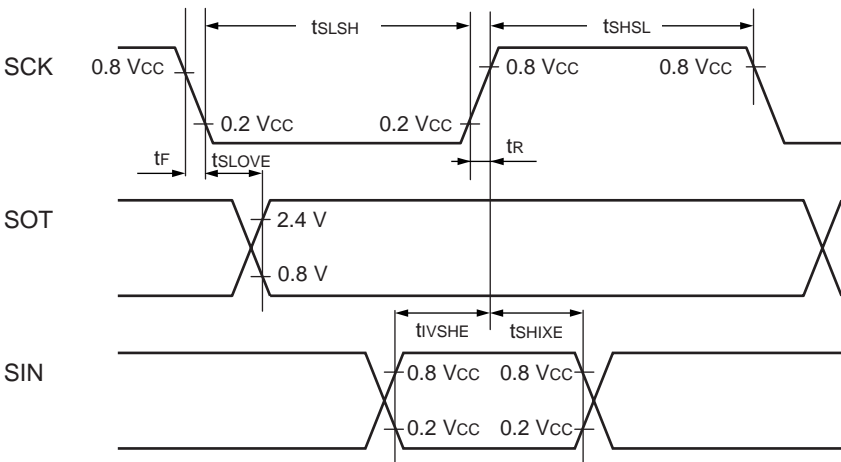

MB95110A Series

Sampling at the falling edge of sampling clock*1 and prohibited serial clock delay*2
 (ESCR register : SCES bit = 1, ECCR register : SCDE bit = 0)

(V_{CC} = 3.3 V, AV_{SS} = V_{SS} = 0.0 V, T_A = -40 °C to +85 °C)

Parameter	Symbol	Pin name	Conditions	Value		Unit
				Min	Max	
Serial clock cycle time	t _{SCYC}	SCK	Internal clock operation output pin : C _L = 80 pF + 1 TTL	5 t _{MCLK} *3	—	ns
SCK↑→SOT delay time	t _{SHOVI}	SCK, SOT		-95	+95	ns
Valid SIN→SCK↓	t _{IVSLI}	SCK, SIN		t _{MCLK} *3 + 190	—	ns
SCK↓→valid SIN hold time	t _{SLIXI}	SCK, SIN		0	—	ns
Serial clock "H" pulse width	t _{SHSL}	SCK	External clock operation output pin : C _L = 80 pF + 1 TTL	3 t _{MCLK} *3 - t _R	—	ns
Serial clock "L" pulse width	t _{SLSH}	SCK		t _{MCLK} *3 + 95	—	ns
SCK↑→SOT delay time	t _{SHOVE}	SCK, SOT		—	2 t _{MCLK} *3 + 95	ns
Valid SIN→SCK↓	t _{IVSLE}	SCK, SIN		190	—	ns
SCK↓→valid SIN hold time	t _{SLIXE}	SCK, SIN		t _{MCLK} *3 + 95	—	ns
SCK fall time	t _F	SCK		—	10	ns
SCK rise time	t _R	SCK	—	10	ns	

*1 : Provide switch function whether sampling of reception data is performed at rising edge or falling edge of the serial clock.

*2 : Serial clock delay function is used to delay half clock for the output signal of serial clock.

*3 : Refer to "(2) Source Clock/Machine Clock" for t_{MCLK}.

- Internal shift clock mode

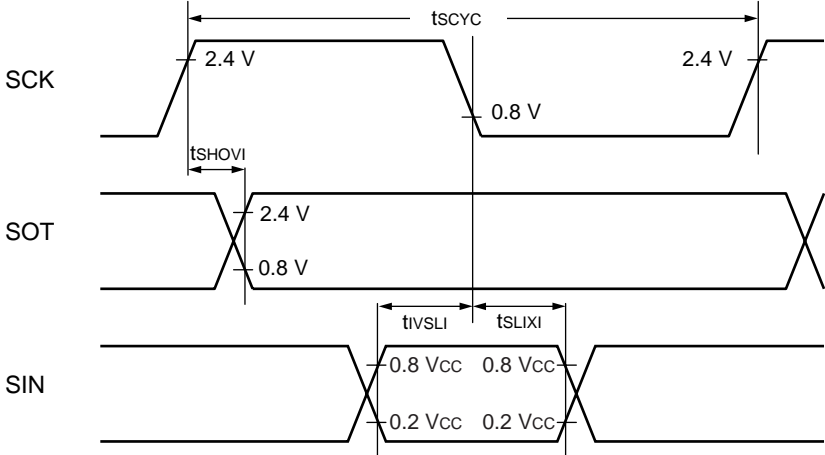

- External shift clock mode

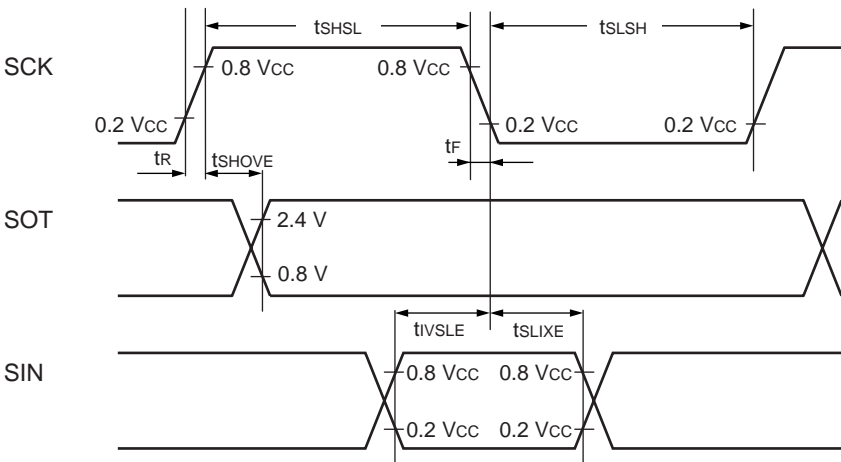

MB95110A Series

Sampling at the rising edge of sampling clock*¹ and enabled serial clock delay*²
 (ESCR register : SCES bit = 0, ECCR register : SCDE bit = 1)

(V_{CC} = 3.3 V, AV_{SS} = V_{SS} = 0.0 V, T_A = - 40 °C to + 85 °C)

Parameter	Sym- bol	Pin name	Conditions	Value		Unit
				Min	Max	
Serial clock cycle time	t _{SCYC}	SCK	Internal clock operation output pin : C _L = 80 pF + 1 TTL	5 t _{MCLK} * ³	—	ns
SCK↑→ SOT delay time	t _{SHOVI}	SCK, SOT		- 95	+ 95	ns
Valid SIN→SCK↓	t _{VSLI}	SCK, SIN		t _{MCLK} * ³ + 190	—	ns
SCK↓→ valid SIN hold time	t _{SLIXI}	SCK, SIN		0	—	ns
SOT→SCK↓ delay time	t _{SOVLI}	SCK, SOT		—	4 t _{MCLK} * ³	ns

*1 : Provide switch function whether sampling of reception data is performed at rising edge or falling edge of the serial clock.

*2 : Serial clock delay function is used to delay half clock for the output signal of serial clock.

*3 : Refer to “ (2) Source Clock/Machine Clock” for t_{MCLK}.

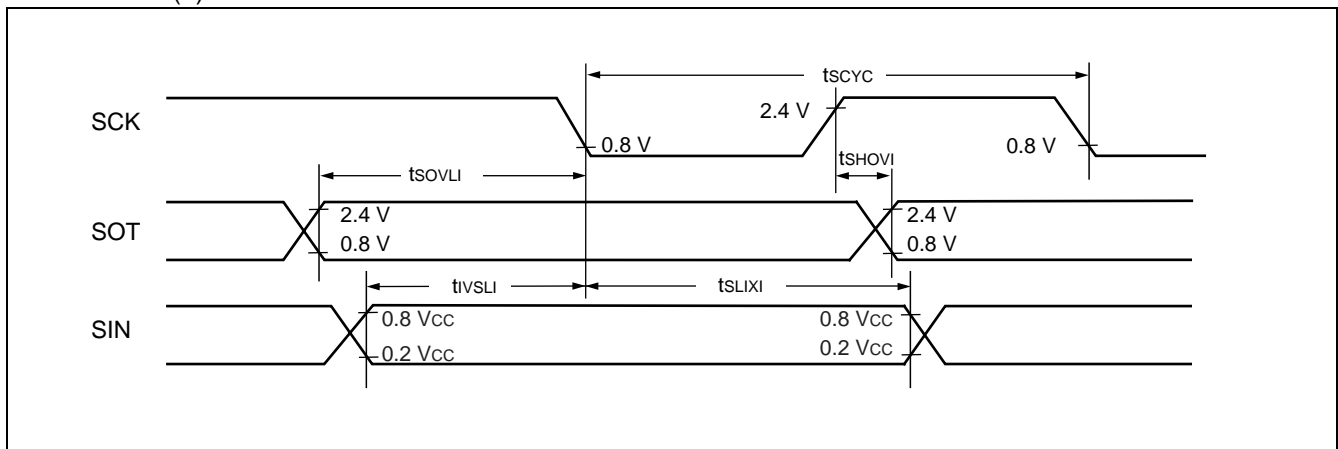

MB95110A Series

Sampling at the falling edge of sampling clock*1 and enabled serial clock delay*2
 (ESCR register : SCES bit = 1, ECCR register : SCDE bit = 1)

($V_{CC} = 3.3\text{ V}$, $AV_{SS} = V_{SS} = 0.0\text{ V}$, $T_A = -40\text{ }^\circ\text{C}$ to $+85\text{ }^\circ\text{C}$)

Parameter	Symbol	Pin name	Conditions	Value		Unit
				Min	Max	
Serial clock cycle time	t_{SCYC}	SCK	Internal clock operating output pin : $C_L = 80\text{ pF} + 1\text{ TTL}$	$5 t_{MCLK}^{*3}$	—	ns
SCK↓→SOT hold time	t_{SLOVI}	SCK, SOT		-95	+95	ns
Valid SIN→SCK↑	t_{IVSHI}	SCK, SIN		$t_{MCLK}^{*3} + 190$	—	ns
SCK↑ → valid SIN hold time	t_{SHIXI}	SCK, SIN		0	—	ns
SOT→SCK↑ delay time	t_{SOVHI}	SCK, SOT		—	$4 t_{MCLK}^{*3}$	ns

*1 : Provide switch function whether sampling of reception data is performed at rising edge or falling edge of the serial clock.

*2 : Serial clock delay function is used to delay half clock for the output signal of serial clock.

*3 : Refer to “ (2) Source Clock/Machine Clock” for t_{MCLK} .

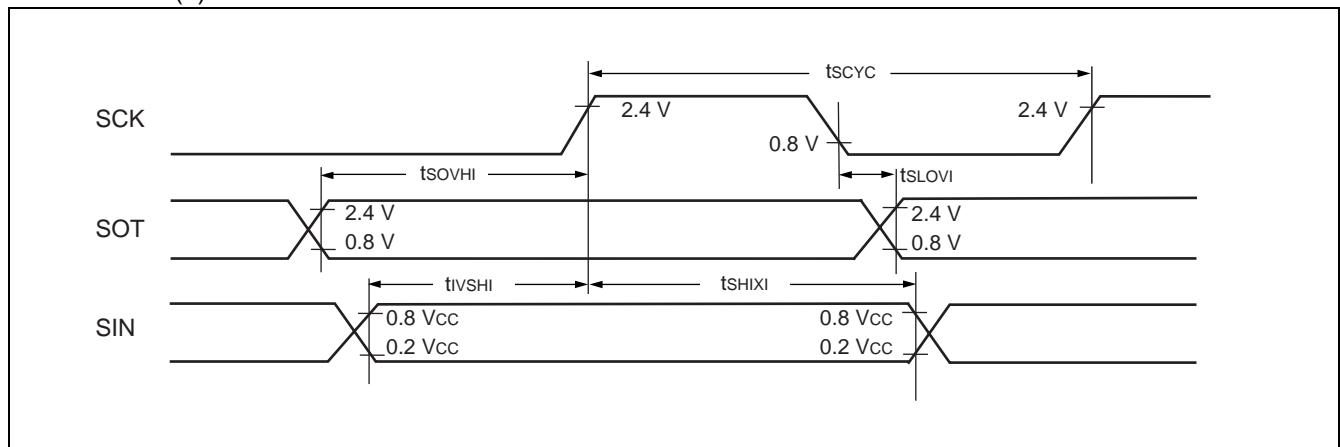

MB95110A Series

(8) I²C Timing

(V_{CC} = 3.3 V, AV_{SS} = V_{SS} = 0.0 V, T_A = -40 °C to +85 °C)

Parameter	Sym- bol	Pin name	Conditions	Value				Unit	Re- marks
				Standard- mode		Fast-mode			
				Min	Max	Min	Max		
SCL clock frequency	f _{SCL}	SCL0	R = 1.7 kΩ, C = 50 pF*1	0	100	0	400	kHz	
(Repeat) Start condition hold time SDA ↓ → SCL ↓	t _{HD;STA}	SCL0 SDA0		4.0	—	0.6	—	μs	
SCL clock "L" width	t _{LOW}	SCL0		4.7	—	1.3	—	μs	
SCL clock "H" width	t _{HIGH}	SCL0		4.0	—	0.6	—	μs	
(Repeat) Start condition setup time SCL ↑ → SDA ↓	t _{SU;STA}	SCL0 SDA0		4.7	—	0.6	—	μs	
Data hold time SCL ↓ → SDA ↓ ↑	t _{HD;DAT}	SCL0 SDA0		0	3.45*2	0	0.9*3	μs	
Data setup time SDA ↓ ↑ → SCL ↑	t _{SU;DAT}	SCL0 SDA0		0.25	—	0.1	—	μs	
Stop condition setup time SCL ↑ → SDA ↑	t _{SU;STO}	SCL0 SDA0		4	—	0.6	—	μs	
Bus free time between stop condition and start condition	t _{BUF}	SCL0 SDA0		4.7	—	1.3	—	μs	

*1 : R, C : Pull-up resistor and load capacitor of the SCL and SDA lines.

*2 : The maximum t_{HD;DAT} have only to be met if the device dose not stretch the "L" width (t_{LOW}) of the SCL signal.

*3 : A Fast-mode I²C-bus device can be used in a Standard-mode I²C-bus system, but the requirement t_{SU;DAT} ≥ 250 ns must then be met.

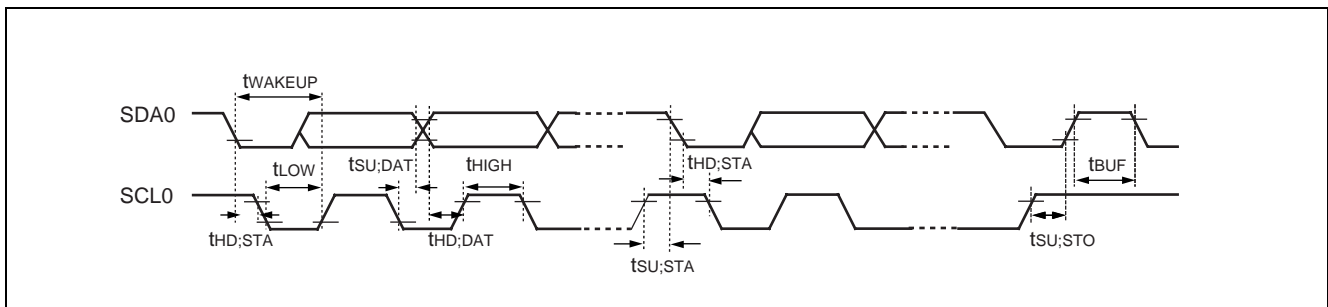

MB95110A Series

(V_{CC} = 3.3 V, AV_{SS} = V_{SS} = 0.0 V, T_A = -40 °C to +85 °C)

Parameter	Sym- bol	Pin name	Condition	Value*2		Unit	Remarks
				Min	Max		
SCL clock "L" width	t _{LOW}	SCL0	R = 1.7 kΩ, C = 50 pF*1	$(2 + nm / 2) t_{MCLK} - 20$	—	ns	Master mode
SCL clock "H" width	t _{HIGH}	SCL0		$(nm / 2) t_{MCLK} - 20$	$(nm / 2) t_{MCLK} + 20$	ns	Master mode
Start condition hold time	t _{HD;STA}	SCL0 SDA0		$(-1 + nm / 2) t_{MCLK} - 20$	$(-1 + nm) t_{MCLK} + 20$	ns	Master mode Maximum value is applied when m, n = 1, 8. Otherwise, the minimum value is applied.
Stop condition setup time	t _{SU;STO}	SCL0 SDA0		$(1 + nm / 2) t_{MCLK} - 20$	$(1 + nm / 2) t_{MCLK} + 20$	ns	Master mode
Start condition setup time	t _{SU;STA}	SCL0 SDA0		$(1 + nm / 2) t_{MCLK} - 20$	$(1 + nm / 2) t_{MCLK} + 20$	ns	Master mode
Bus free time between stop condition and start condition	t _{BUF}	SCL0 SDA0		$(2 nm + 4) t_{MCLK} - 20$	—	ns	
Data hold time	t _{HD;DAT}	SCL0 SDA0		$3 t_{MCLK} - 20$	—	ns	Master mode
Data setup time	t _{SU;DAT}	SCL0 SDA0		$(-2 + nm / 2) t_{MCLK} - 20$	$(-1 + nm / 2) t_{MCLK} + 20$	ns	Master mode When assuming that "L" of SCL is not extended, the minimum value is applied to first bit of continuous data. Otherwise, the maximum value is applied.
Setup time between clearing interrupt and SCL rising	t _{SU;INT}	SCL0		$(nm / 2) t_{MCLK} - 20$	$(1 + nm / 2) t_{MCLK} + 20$	ns	Minimum value is applied to interrupt at 9th SCL↓. Maximum value is applied to interrupt at 8th SCL↓.
SCL clock "L" width	t _{LOW}	SCL0		$4 t_{MCLK} - 20$	—	ns	At reception
SCL clock "H" width	t _{HIGH}	SCL0		$4 t_{MCLK} - 20$	—	ns	At reception
Start condition detection	t _{HD;STA}	SCL0 SDA0		$2 t_{MCLK} - 20$	—	ns	Undetected when 1 t _{MCLK} is used at reception
Stop condition detection	t _{SU;STO}	SCL0 SDA0		$2 t_{MCLK} - 20$	—	ns	Undetected when 1 t _{MCLK} is used at reception
Restart condition detection condition	t _{SU;STA}	SCL0 SDA0		$2 t_{MCLK} - 20$	—	ns	Undetected when 1 t _{MCLK} is used at reception
Bus free time	t _{BUF}	SCL0 SDA0		$2 t_{MCLK} - 20$	—	ns	At reception
Data hold time	t _{HD;DAT}	SCL0 SDA0		$2 t_{MCLK} - 20$	—	ns	At slave transmission mode
Data setup time	t _{SU;DAT}	SCL0 SDA0		$t_{LOW} - 3 t_{MCLK} - 20$	—	ns	At slave transmission mode

(Continued)

MB95110A Series

(Continued)

Parameter	Symbol	Pin name	Condition	Value*2		Unit	Remarks
				Min	Max		
Data hold time	$t_{HD;DAT}$	SCL0 SDA0	R = 1.7 k Ω , C = 50 pF*1	0	—	ns	At reception
Data setup time	$t_{SU;DAT}$	SCL0 SDA0		$t_{MCLK} - 20$	—	ns	At reception
SDA \downarrow →SCL \uparrow (at wake-up function)	t_{WAKEUP}	SCL0 SDA0		Oscillation stabilization wait time + 2 $t_{MCLK} - 20$	—	ns	

*1 : R, C : Pull-up resistor and load capacitor of the SCL and SDA lines.

*2 : • Refer to “ (2) Source Clock/Machine Clock” for t_{MCLK} .

- m is CS4 bit and CS3 bit (bit 4 and bit 3) of clock control register (ICCR) .
- n is CS2 bit to CS0 bit (bit 2 to bit 0) of clock control register (ICCR) .
- Actual timing of I²C is determined by m and n values set by the machine clock (t_{MCLK}) and CS4 to CS0 of ICCR0 register.
- Standard-mode :
m and n can be set at the range : 0.9 MHz < t_{MCLK} (machine clock) < 10 MHz.
Setting of m and n limits the machine clock that can be used below.

(m, n) = (1, 8)	: 0.9 MHz < t_{MCLK} ≤ 1 MHz
(m, n) = (1, 22), (5, 4), (6, 4), (7, 4), (8, 4)	: 0.9 MHz < t_{MCLK} ≤ 2 MHz
(m, n) = (1, 38), (5, 8), (6, 8), (7, 8), (8, 8)	: 0.9 MHz < t_{MCLK} ≤ 4 MHz
(m, n) = (1, 98)	: 0.9 MHz < t_{MCLK} ≤ 10 MHz
- Fast-mode :
m and n can be set at the range : 3.3 MHz < t_{MCLK} (machine clock) < 10 MHz.
Setting of m and n limits the machine clock that can be used below.

(m, n) = (1, 8)	: 3.3 MHz < t_{MCLK} ≤ 4 MHz
(m, n) = (1, 22), (5, 4)	: 3.3 MHz < t_{MCLK} ≤ 8 MHz
(m, n) = (6, 4)	: 3.3 MHz < t_{MCLK} ≤ 10 MHz

5. A/D Converter

(1) A/D Converter Electrical Characteristics

($AV_{CC} = V_{CC} = 1.8 \text{ V}$ to 3.3 V [Flash memory product], $AV_{CC} = V_{CC} = 1.8 \text{ V}$ to 3.6 V [MASK ROM product], $AV_{SS} = V_{SS} = 0.0 \text{ V}$, $T_A = -40 \text{ }^\circ\text{C}$ to $+85 \text{ }^\circ\text{C}$)

Parameter	Symbol	Value			Unit	Remarks
		Min	Typ	Max		
Resolution	—	—	—	10	bit	
Total error		-3.0	—	+3.0	LSB	
Linearity error		-2.5	—	+2.5	LSB	
Differential linear error		-1.9	—	+1.9	LSB	
Zero transition voltage	V_{OT}	$AV_{SS} - 1.5$ LSB	$AV_{SS} + 0.5$ LSB	$AV_{SS} + 2.5$ LSB	V	Flash memory product : $2.7 \text{ V} \leq AV_{CC} \leq 3.3 \text{ V}$ MASK ROM product : $2.7 \text{ V} \leq AV_{CC} \leq 3.6 \text{ V}$
		$AV_{SS} - 0.5$ LSB	$AV_{SS} + 1.5$ LSB	$AV_{SS} + 3.5$ LSB	V	$1.8 \text{ V} \leq AV_{CC} < 2.7 \text{ V}$
Full-scale transition voltage	V_{FST}	$AV_{CC} - 3.5$ LSB	$AV_{CC} - 1.5$ LSB	$AV_{CC} + 0.5$ LSB	V	Flash memory product : $2.7 \text{ V} \leq AV_{CC} \leq 3.3 \text{ V}$ MASK ROM product : $2.7 \text{ V} \leq AV_{CC} \leq 3.6 \text{ V}$
		$AV_{CC} - 2.5$ LSB	$AV_{CC} - 0.5$ LSB	$AV_{CC} + 1.5$ LSB	V	$1.8 \text{ V} \leq AV_{CC} < 2.7 \text{ V}$
Compare time	—	1.3	—	140	μs	Flash memory product : $2.7 \text{ V} \leq AV_{CC} \leq 3.3 \text{ V}$ MASK ROM product : $2.7 \text{ V} \leq AV_{CC} \leq 3.6 \text{ V}$
		20	—	140	μs	$1.8 \text{ V} \leq AV_{CC} < 2.7 \text{ V}$
Sampling time	—	0.4	—	∞	μs	Flash memory product : $2.7 \text{ V} \leq AV_{CC} \leq 3.3 \text{ V}$ MASK ROM product : $2.7 \text{ V} \leq AV_{CC} \leq 3.6 \text{ V}$ external impedance < at $1.8 \text{ k}\Omega$
		30	—	∞	μs	$1.8 \text{ V} \leq AV_{CC} < 2.7 \text{ V}$ external impedance < at $14.8 \text{ k}\Omega$
Analog input current	I_{AIN}	-0.3	—	+0.3	μA	
Analog input voltage	V_{AIN}	AV_{SS}	—	AV_{CC}	V	
Reference voltage	—	$AV_{SS} + 1.8$	—	AV_{CC}	V	AV_{CC} pin
Reference voltage supply current	I_R	—	400	600	μA	AV_{CC} pin, During A/D operation
	I_{RH}	—	—	5	μA	AV_{CC} pin, at stop mode

MB95110A Series

(2) Notes on Using A/D Converter

• About the external impedance of analog input and its sampling time

A/D converter with sample and hold circuit. If the external impedance is too high to keep sufficient sampling time, the analog voltage charged to the internal sample and hold capacitor is insufficient, adversely affecting A/D conversion precision. Therefore, to satisfy the A/D conversion precision standard, consider the relationship between the external impedance and minimum sampling time and either adjust the resistor value and operating frequency or decrease the external impedance so that the sampling time is longer than the minimum value. Also, if the sampling time cannot be sufficient, connect a capacitor of about 0.1 μF to the analog input pin.

• Analog input equivalent circuit

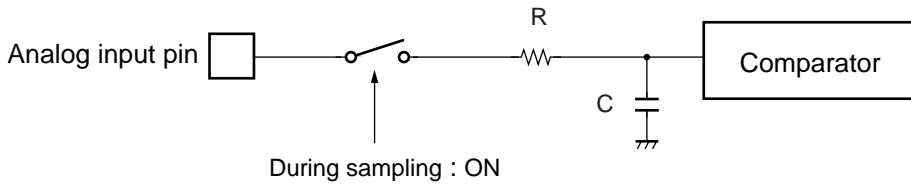

	R	C
$2.7 \text{ V} \leq AV_{CC} \leq 3.6 \text{ V}$	1.7 k Ω (Max)	14.5 pF (Max)
$1.8 \text{ V} \leq AV_{CC} < 2.7 \text{ V}$	84 k Ω (Max)	25.2 pF (Max)

Note : The values are reference values.

• The relationship between external impedance and minimum sampling time

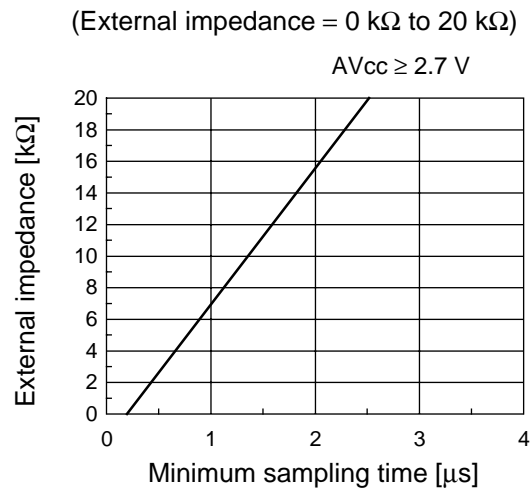
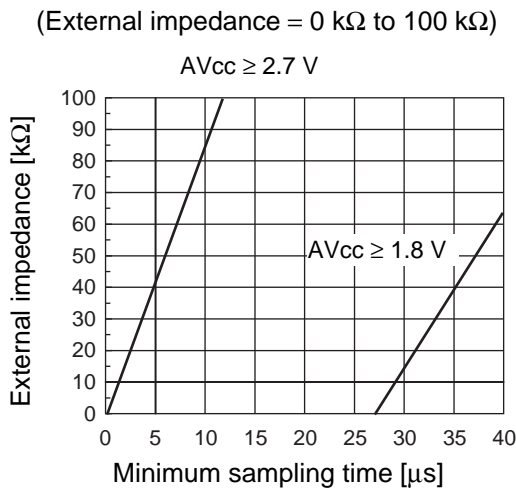

• About errors

As $|AV_{CC} - AV_{SS}|$ becomes smaller, values of relative errors grow larger.

(3) Definition of A/D Converter Terms

- Resolution
The level of analog variation that can be distinguished by the A/D converter.
When the number of bits is 10, analog voltage can be divided into $2^{10} = 1024$.
- Linearity error (unit : LSB)
The deviation between the value along a straight line connecting the zero transition point (“00 0000 0000” ← → “00 0000 0001”) of a device and the full-scale transition point (“11 1111 1111” ← → “11 1111 1110”) compared with the actual conversion values obtained.
- Differential linear error (Unit : LSB)
Deviation of input voltage, which is required for changing output code by 1 LSB, from an ideal value.
- Total error (unit: LSB)
Difference between actual and theoretical values, caused by a zero transition error, full-scale transition error, linearity error, quantum error, and noise.

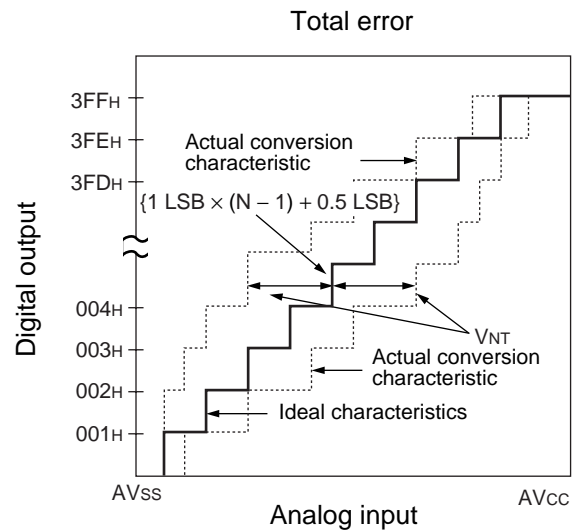
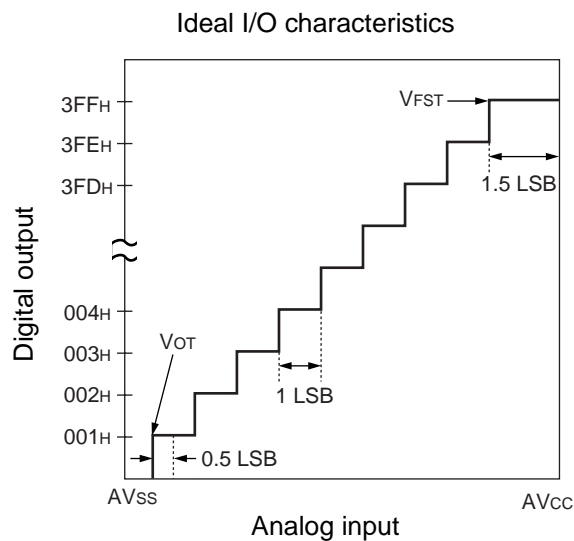

$$1 \text{ LSB} = \frac{AV_{CC} - AV_{SS}}{1024} \text{ (V)}$$

$$\text{Total error of digital output } N = \frac{V_{NT} - \{1 \text{ LSB} \times (N - 1) + 0.5 \text{ LSB}\}}{1 \text{ LSB}} \text{ [LSB]}$$

N : A/D converter digital output value

V_{NT} : A voltage at which digital output transits from (N - 1) to N.

(Continued)

MB95110A Series

(Continued)

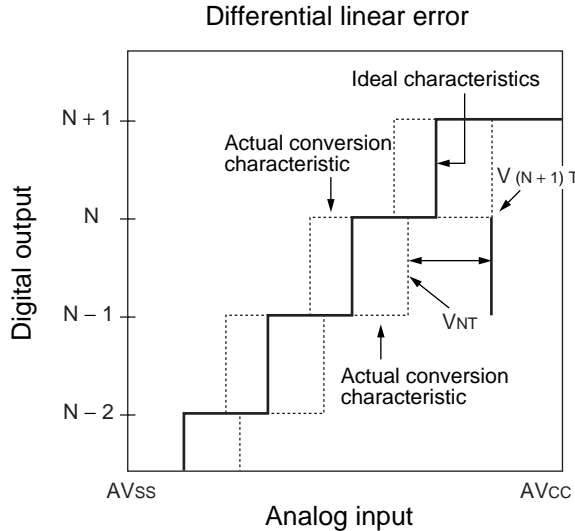
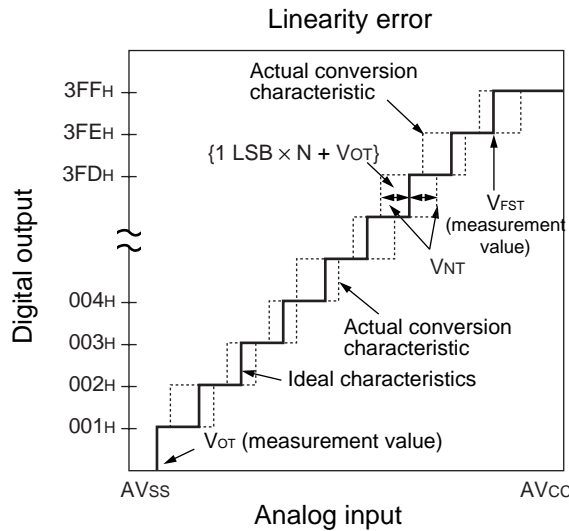
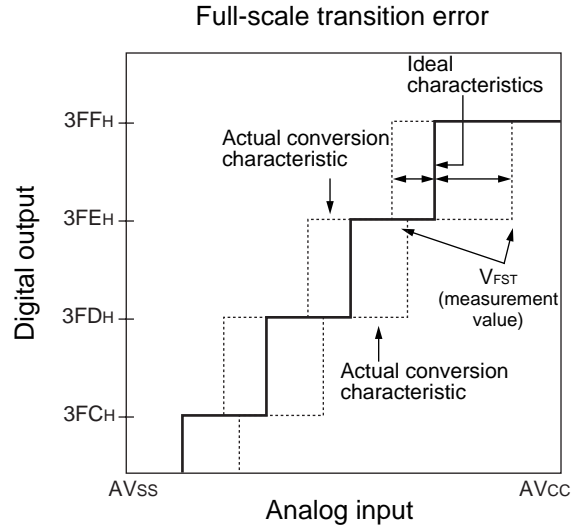
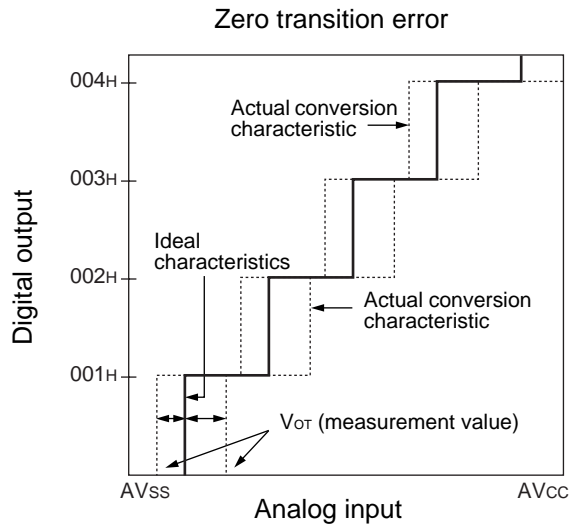

$$\text{Linear error in digital output } N = \frac{V_{NT} - \{1 \text{ LSB} \times N + V_{OT}\}}{1 \text{ LSB}}$$

$$\text{Differential linear error in digital output } N = \frac{V_{(N+1)T} - V_{NT}}{1 \text{ LSB}} - 1$$

N : A/D converter digital output value

V_{NT} : A voltage at which digital output transits from (N - 1) to N.

V_{OT} (Ideal value) = $AV_{SS} + 0.5 \text{ LSB}$ [V]

V_{FST} (Ideal value) = $AV_{CC} - 1.5 \text{ LSB}$ [V]

6. Flash Memory Program/Erase Characteristics

Parameter	Value			Unit	Remarks
	Min	Typ	Max		
Sector erase time (4 Kbytes sector)	—	0.2* ¹	3.0* ²	s	Excludes 00 _H programming prior erasure
Sector erase time (16 Kbytes sector)	—	0.5* ¹	12.0* ²	s	Excludes 00 _H programming prior erasure
Byte programming time	—	32	3600	μs	Excludes system-level overhead
Erase/program cycle	10000	—	—	cycle	
Power supply voltage at erase/program	2.7	—	3.3	V	
Flash data retention time	20* ³	—	—	year	Average T _A = +85 °C

*1 : T_A = +25 °C, V_{CC} = 3.0 V, 10000 cycles

*2 : T_A = +85 °C, V_{CC} = 2.7 V, 10000 cycles

*3 : This value comes from the technology qualification (using Arrhenius equation to translate high temperature measurements into normalized value at +85 °C) .

MB95110A Series

EXAMPLE CHARACTERISTICS

MB95116A current characteristics

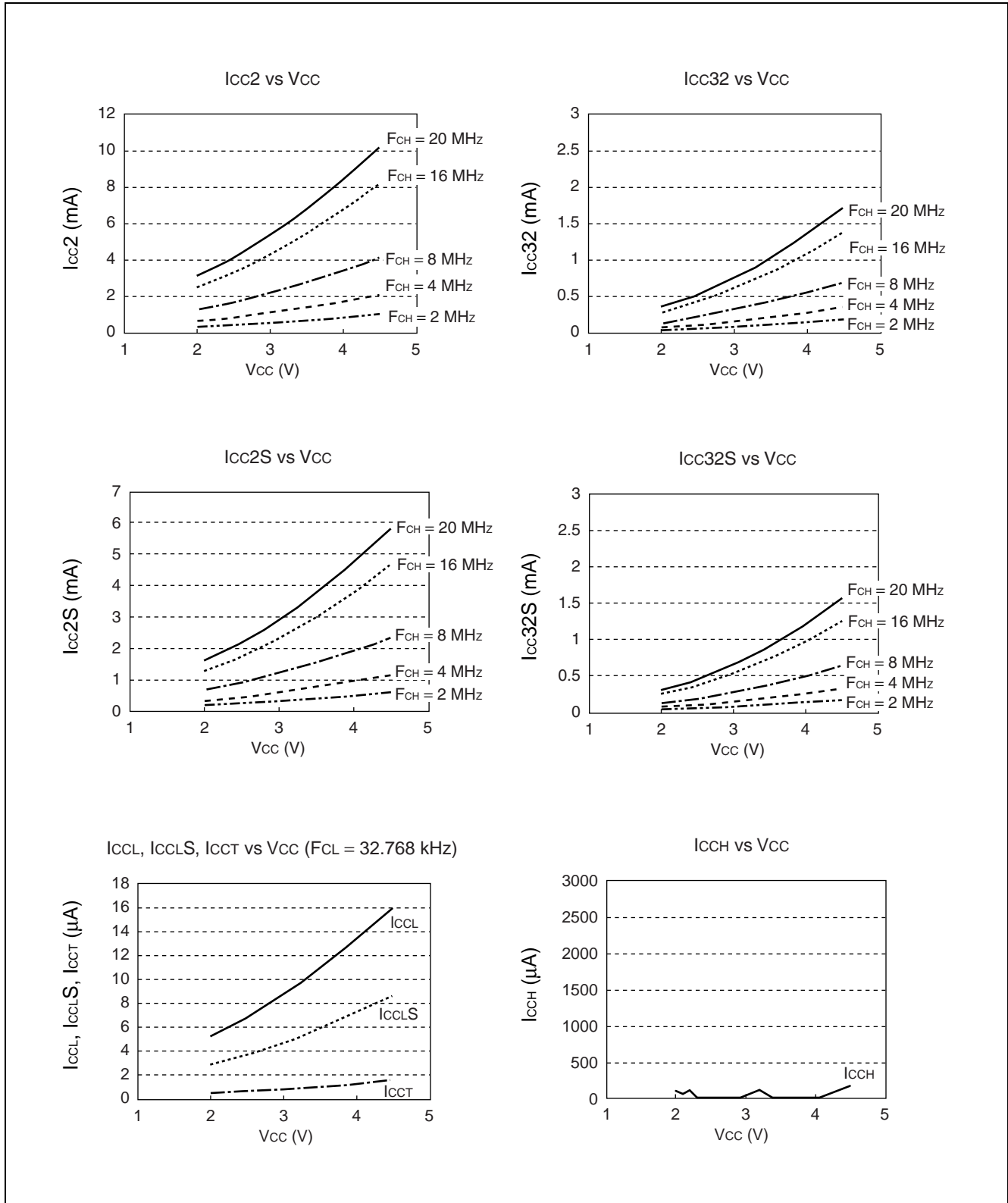

• MB95F118AS/AW current characteristics

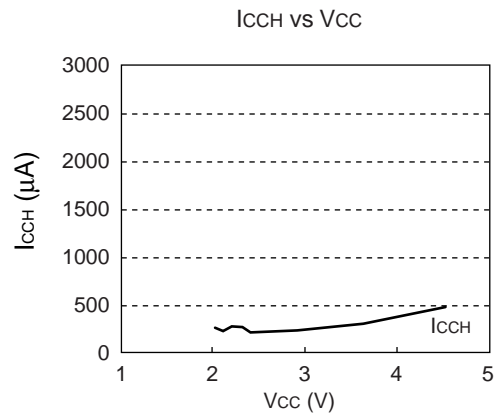
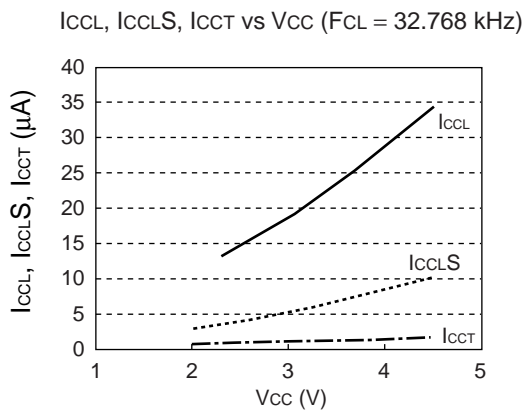
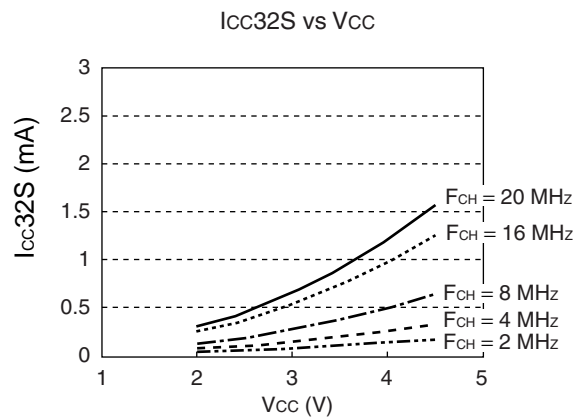
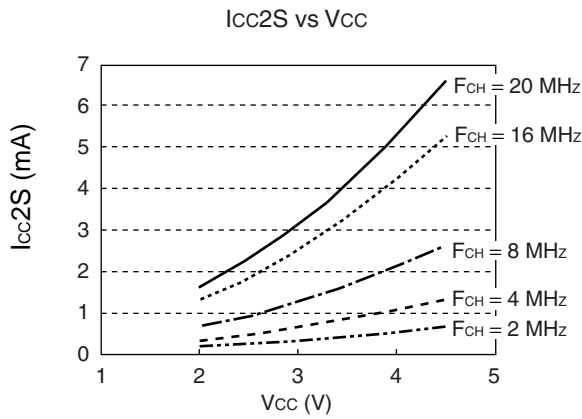
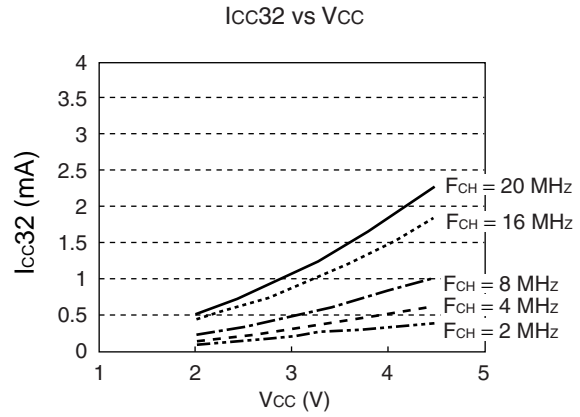
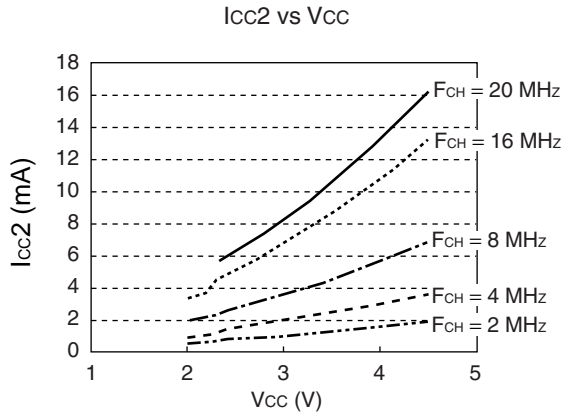

MB95110A Series

• MB95116A current temperature characteristics

$F_{CH} = 21$ [MHz], $F_{CL} = 32.768$ [kHz]

$V_{CC} = 3.3$ [V]

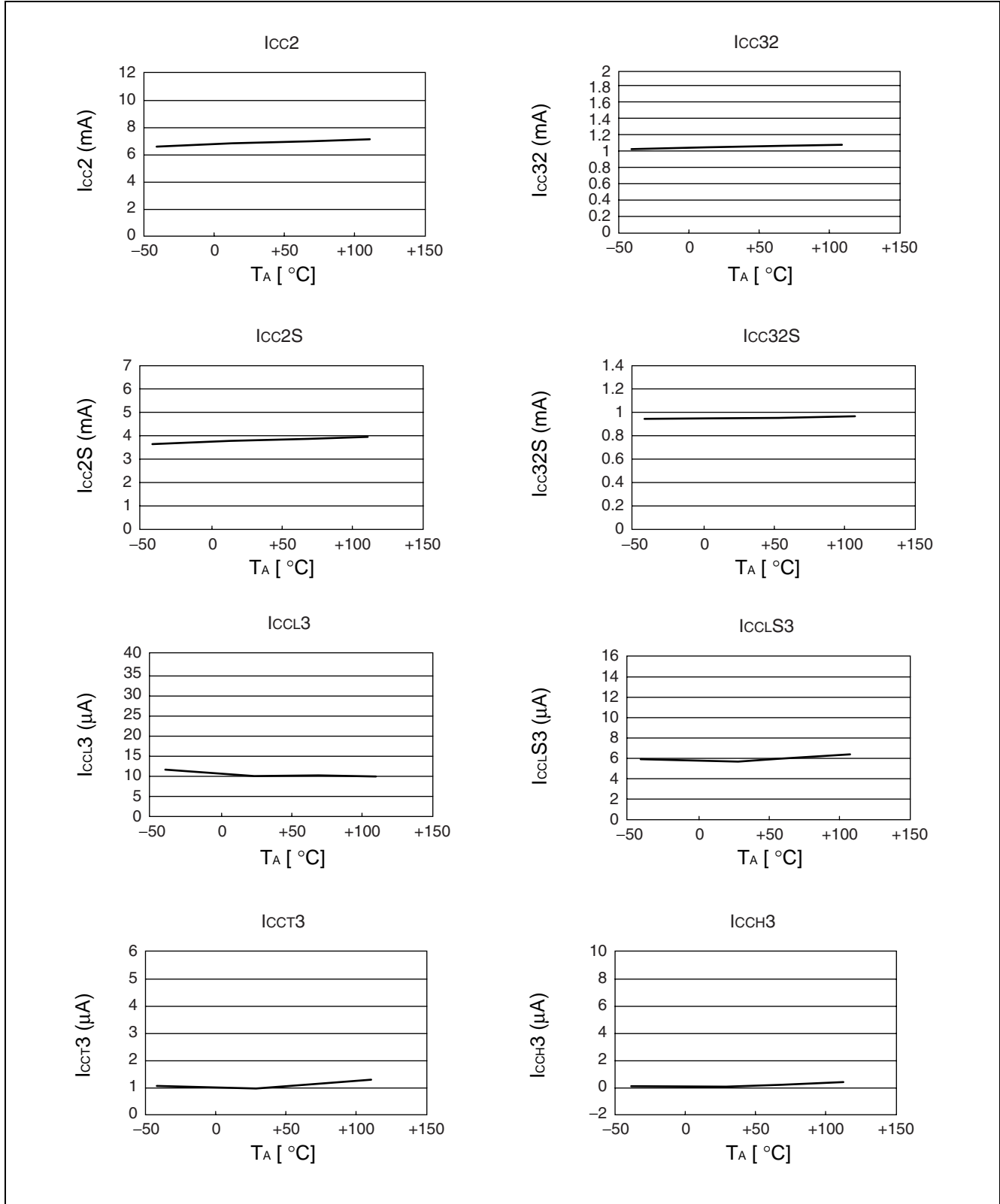

• MB95F118AS/AW current temperature characteristics

$F_{CH} = 21$ [MHz], $F_{CL} = 32.768$ [kHz]

$V_{CC} = 3.3$ [V]

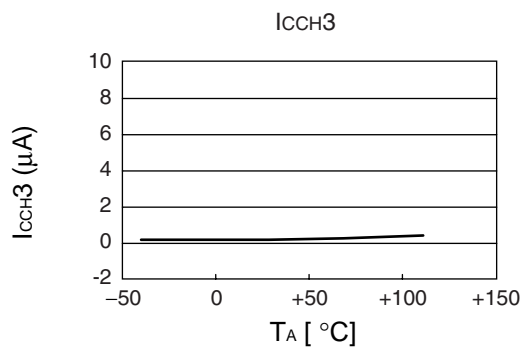
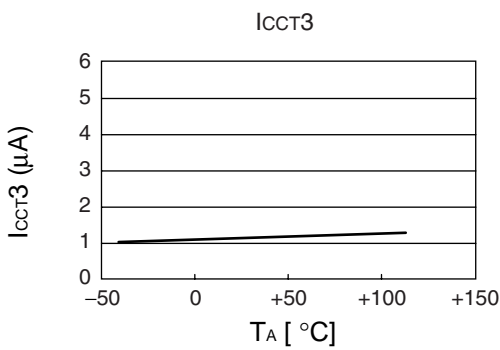
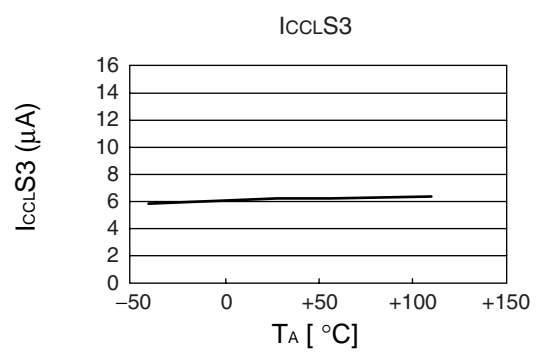
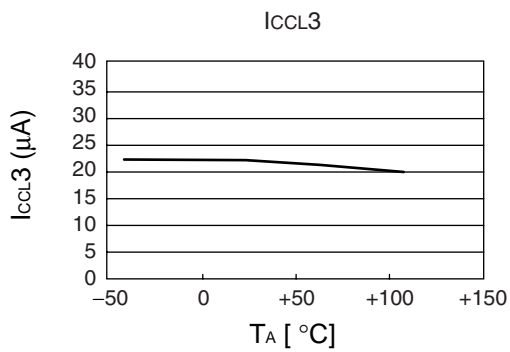
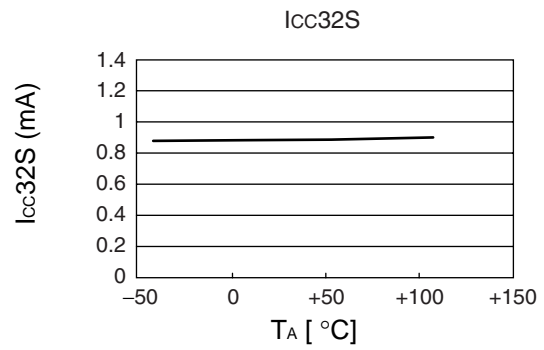
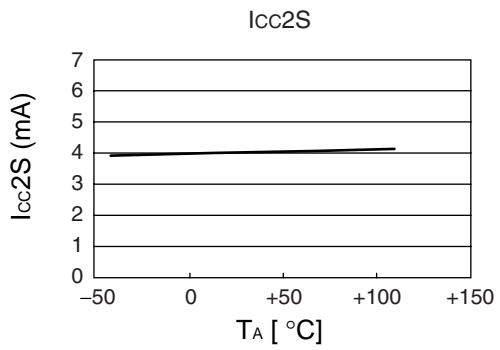
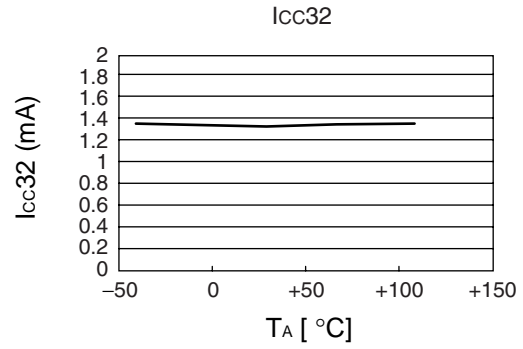
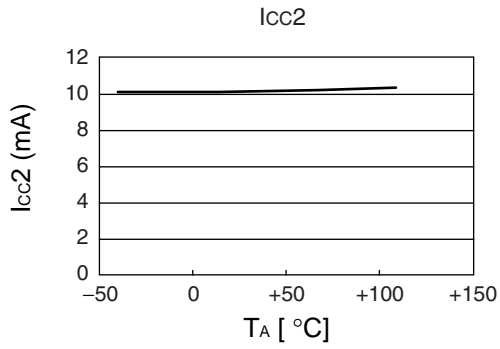

MB95110A Series

• MB95116A/MB95F118AS/AW input characteristics

MB95F118AS/AW
Hysteresis input characteristics of CMOS input level
 $T_A = +25\text{ }^\circ\text{C}$

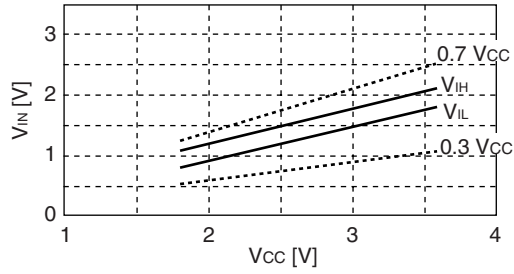

MB95116A
Hysteresis input characteristics of CMOS input level
 $T_A = +25\text{ }^\circ\text{C}$

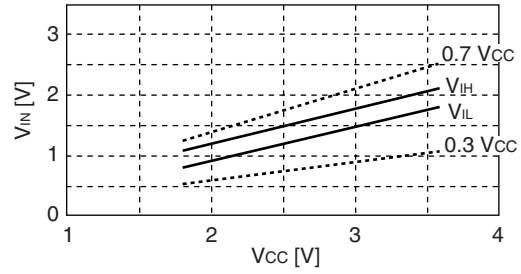

MB95F118AS/AW
Hysteresis input characteristics
 $T_A = +25\text{ }^\circ\text{C}$

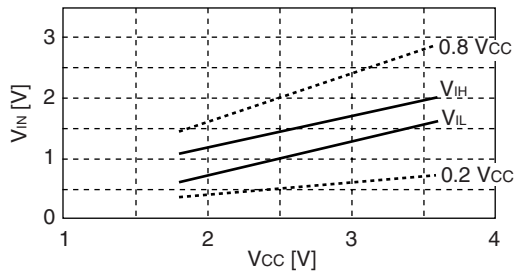

MB95116A
Hysteresis input characteristics
 $T_A = +25\text{ }^\circ\text{C}$

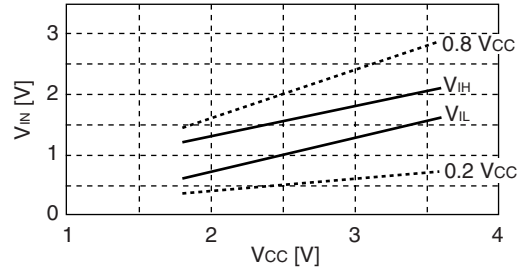

MB95F118AS/AW
CMOS input characteristics
 $T_A = +25\text{ }^\circ\text{C}$

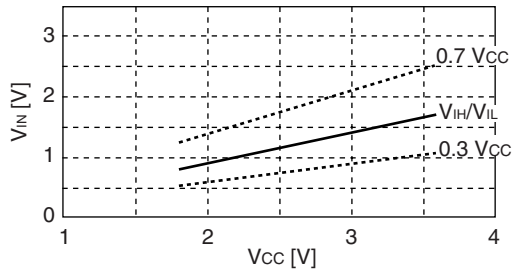

MB95110A Series

• MB95116A/MB95F118AS/AW “H” level output voltage characteristics

V_{OH1} : Output pin of other than P00 to P07 (Min)

V_{OH2} : P00 to P07 (Min)

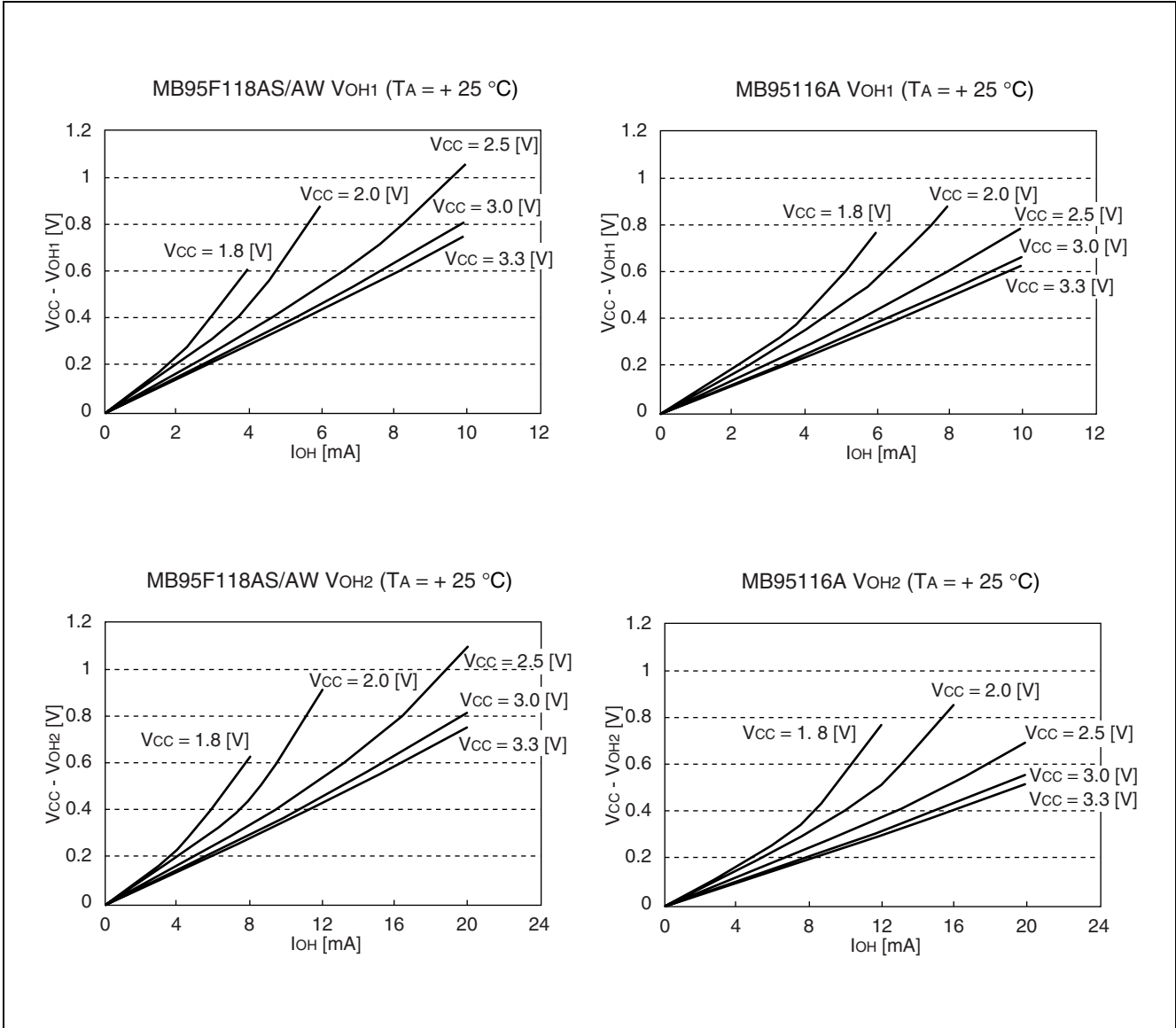

MB95110A Series

- MB95116A/MB95F118AS/AW “L” level output voltage characteristics

V_{OH1} : Output pin of other than P00 to P07 (Max)

V_{OH2} : P00 to P07 (Max)

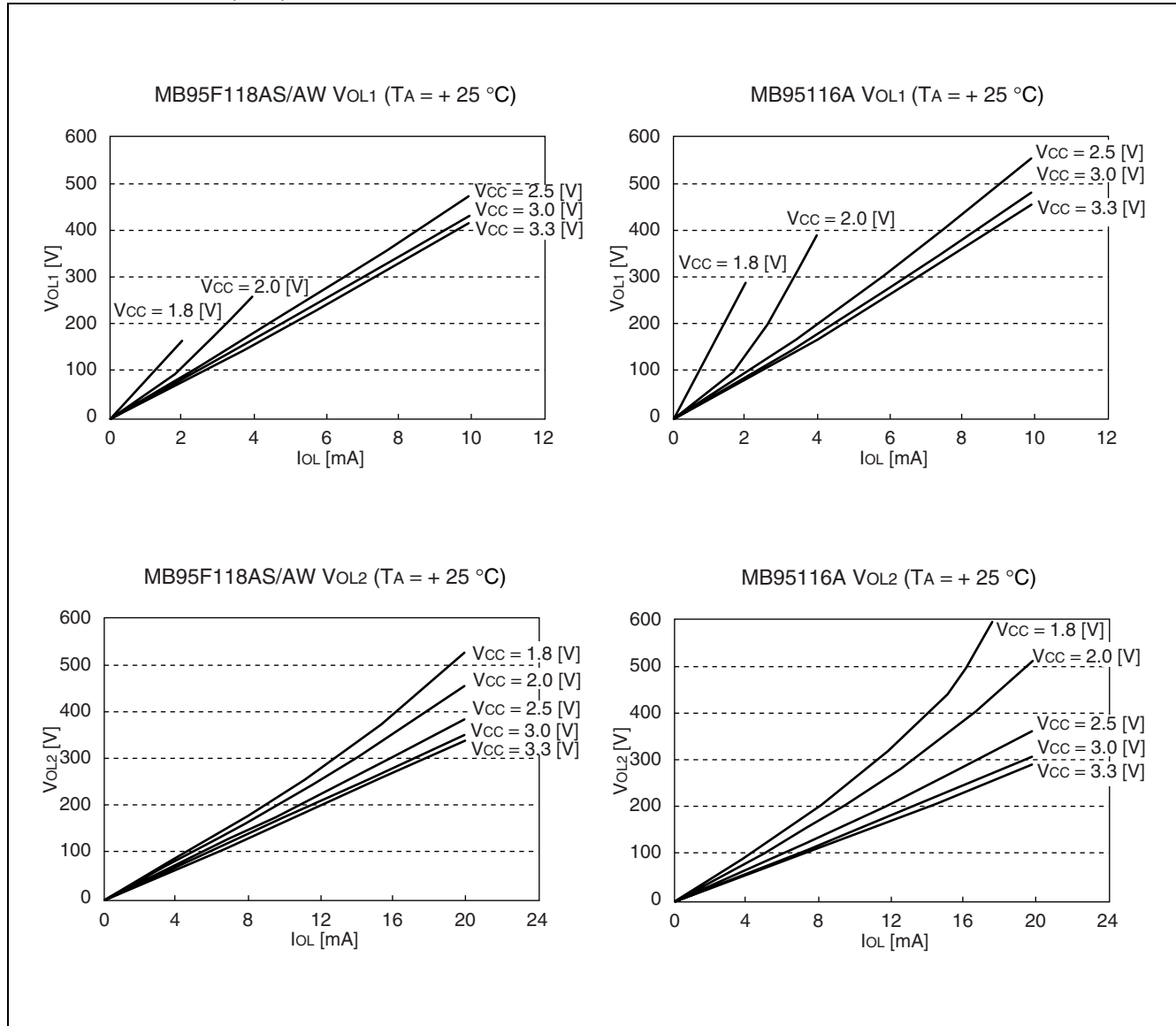

■ MASK OPTIONS

No	Part number	MB95116A	MB95F118AS	MB95F118AW	MB95FV100B-101
	Specifying procedure	Specify when ordering MASK	Setting disabled	Setting disabled	Setting disabled
1	Clock mode select • Single-system clock mode • Dual-system clock mode	Selectable	Single-system clock mode	Dual-system clock mode	Changing by the switch on MCU board
2	Low voltage detection reset* • With low voltage detection reset • Without low voltage detection reset	No	No	No	No
3	Selection of oscillation stabilization wait time • Selectable the initial value of main clock oscillation stabilization wait time	Selectable 1 : $(2^2 - 2) / F_{CH}$ 2 : $(2^{12} - 2) / F_{CH}$ 3 : $(2^{13} - 2) / F_{CH}$ 4 : $(2^{14} - 2) / F_{CH}$	Fixed to oscillation stabilization wait time of $(2^{14}-2) / F_{CH}$	Fixed to oscillation stabilization wait time of $(2^{14}-2) / F_{CH}$	Fixed to oscillation stabilization wait time of $(2^{14}-2) / F_{CH}$

* : Low voltage detection reset is options of 5-V products.

■ ORDERING INFORMATION

Part number	Package	Remarks
MB95116APV2 MB95F118ASPV2 MB95F118AWPV2	48-pin plastic BCC (LCC-48P-M09)	
MB95116APMT MB95F118ASPMT MB95F118AWPMT	48-pin plastic LQFP (FPT-48P-M26)	
MB95116APMC MB95F118ASPMC MB95F118AWPMC	52-pin plastic LQFP (FPT-52P-M01)	
MB2146-301 (MB95FV100B-101PBT)	MCU board (224-pin plastic PFBGA) (BGA-224P-M08)	

MB95110A Series

PACKAGE DIMENSIONS

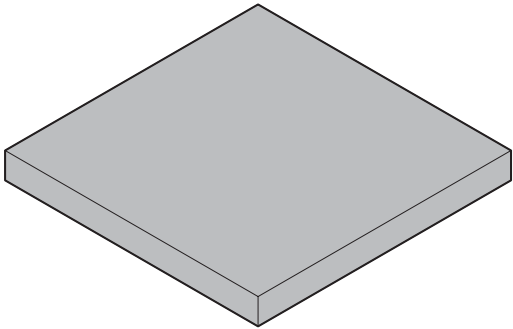
<p style="text-align: center;">48-pin plastic BCC</p>  <p style="text-align: center;">(LCC-48P-M09)</p>	Lead pitch	0.50 mm
	Package width × package length	7.00 mm × 7.00 mm
	Sealing method	Plastic mold
	Mounting height	0.80 mm Max
	Weight	0.06 g

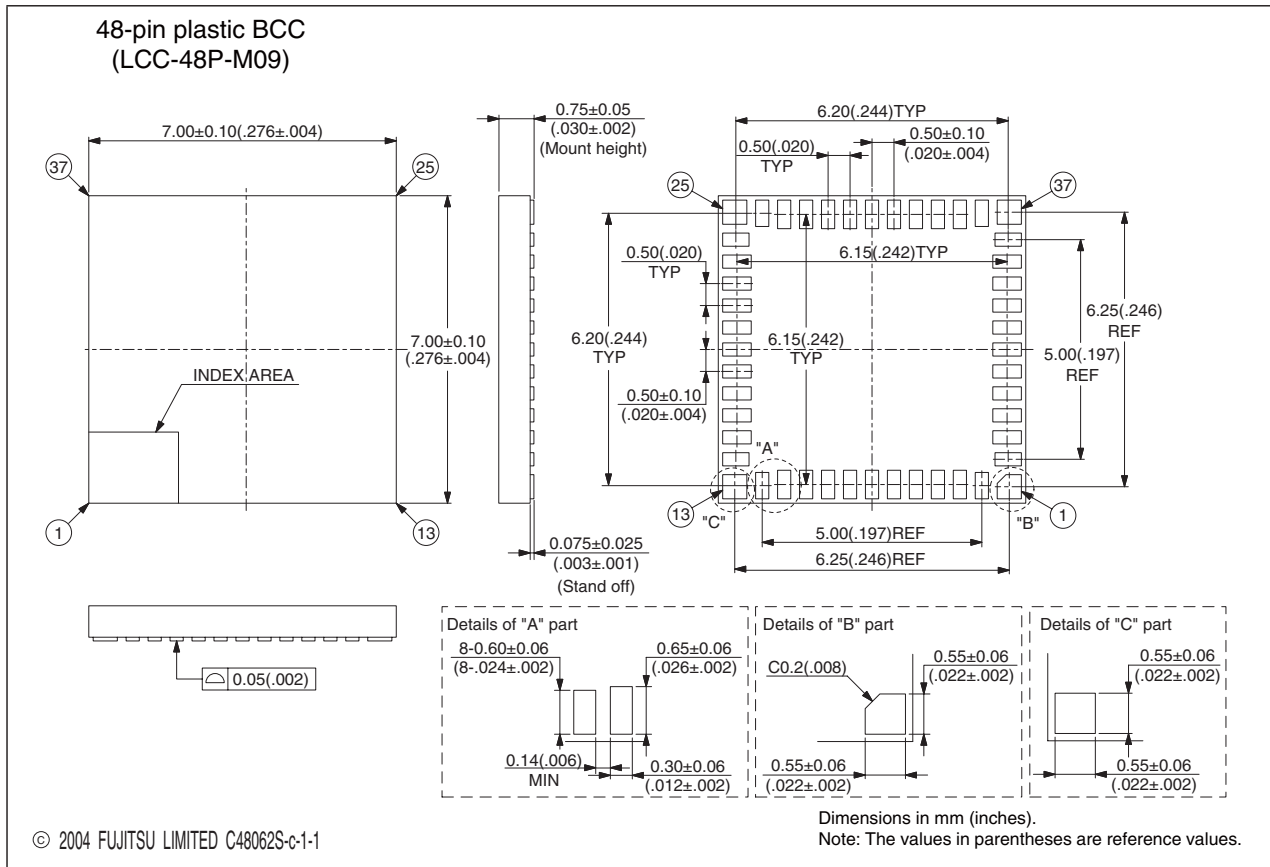

(Continued)

MB95110A Series

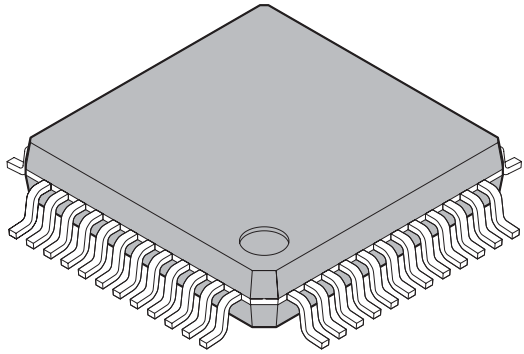
<p style="text-align: center;">48-pin plastic LQFP</p>  <p style="text-align: center;">(FPT-48P-M26)</p>	Lead pitch	0.50 mm
	Package width × package length	7 × 7 mm
	Lead shape	Gullwing
	Sealing method	Plastic mold
	Mounting height	1.70 mm MAX
	Weight	0.17 g
	Code (Reference)	P-LFQFP48-7×7-0.50

48-pin plastic LQFP
(FPT-48P-M26)

Note 1) * : These dimensions include resin protrusion.
 Note 2) Pins width and pins thickness include plating thickness.
 Note 3) Pins width do not include tie bar cutting remainder.

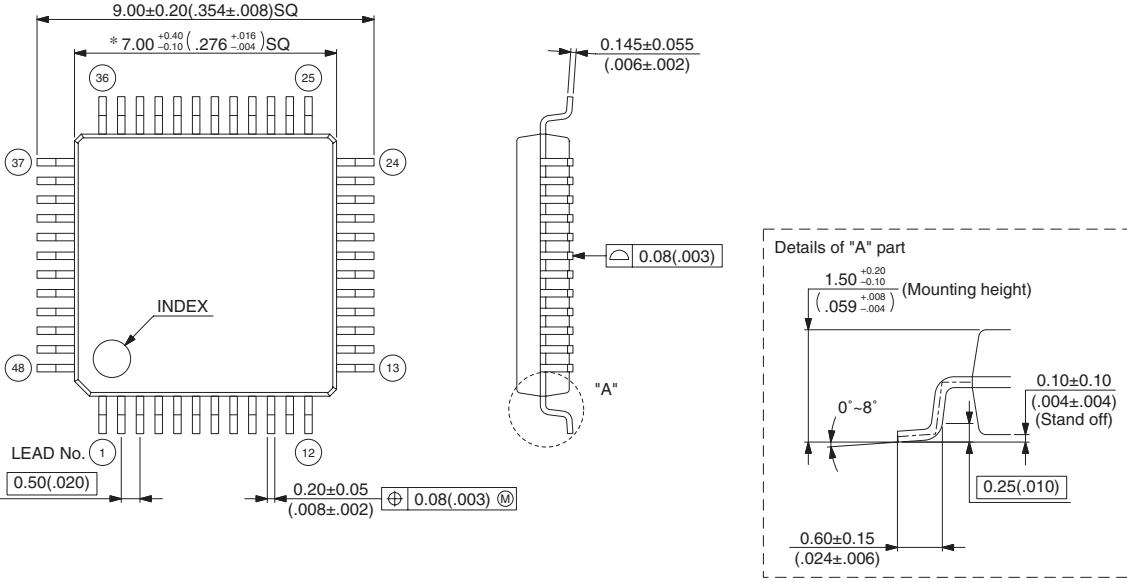

Top view dimensions:
 Overall width: 9.00 ± 0.20 (.354 ± .008) SQ
 Pin pitch: $* 7.00^{+0.40}_{-0.10}$ (.276 $^{+0.16}_{-0.04}$) SQ
 Lead No. 1: 0.50 (.020)
 Pin thickness: 0.20 ± 0.05 (.008 ± .002) $\oplus 0.08$ (.003) M

Side view dimensions:
 Lead thickness: 0.145 ± 0.055 (.006 ± .002)
 Lead width: 0.08 (.003)

Details of "A" part:
 Mounting height: $1.50^{+0.20}_{-0.10}$ (.059 $^{+0.008}_{-0.004}$)
 Stand off: 0.10 ± 0.10 (.004 ± .004)
 Lead width: 0.25 (.010)
 Lead thickness: 0.60 ± 0.15 (.024 ± .006)
 Lead angle: 0° ~ 8°

© 2003 FUJITSU LIMITED F48040S-c-2-2

Dimensions in mm (inches).
 Note: The values in parentheses are reference values.

(Continued)

MB95110A Series

(Continued)

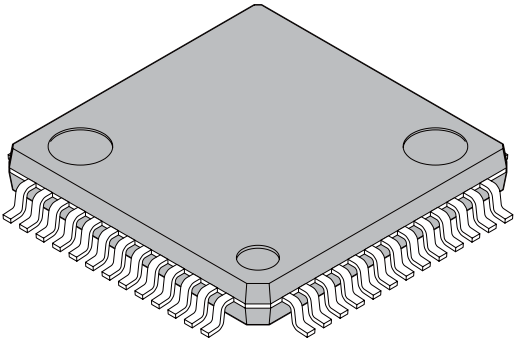
<p style="text-align: center;">52-pin plastic LQFP</p>  <p style="text-align: center;">(FPT-52P-M01)</p>	Lead pitch	0.65 mm
	Package width × package length	10.0 × 10.0 mm
	Lead shape	Gullwing
	Sealing method	Plastic mold
	Mounting height	1.70 mm Max
	Code (Reference)	P-LQFP52-10×10-0.65

52-pin plastic LQFP
(FPT-52P-M01)

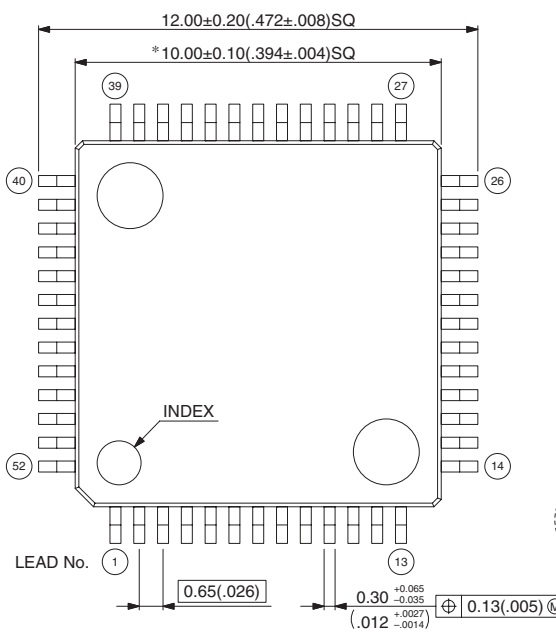

Note 1) * : These dimensions do not include resin protrusion.
 Note 2) Pins width and pins thickness include plating thickness.
 Note 3) Pins width do not include tie bar cutting remainder.

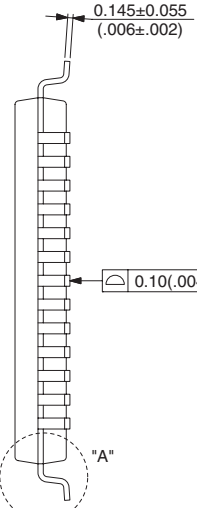

Details of "A" part

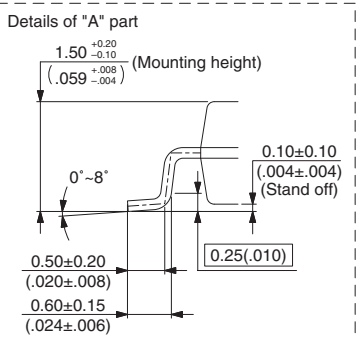

© 2005 FUJITSU LIMITED F52001S-c-1-1

Dimensions in mm (inches).
 Note: The values in parentheses are reference values

MB95110A Series

The information for microcontroller supports is shown in the following homepage.
<http://www.fujitsu.com/global/services/microelectronics/product/micom/support/index.html>

FUJITSU LIMITED

All Rights Reserved.

The contents of this document are subject to change without notice. Customers are advised to consult with FUJITSU sales representatives before ordering.

The information, such as descriptions of function and application circuit examples, in this document are presented solely for the purpose of reference to show examples of operations and uses of Fujitsu semiconductor device; Fujitsu does not warrant proper operation of the device with respect to use based on such information. When you develop equipment incorporating the device based on such information, you must assume any responsibility arising out of such use of the information. Fujitsu assumes no liability for any damages whatsoever arising out of the use of the information.

Any information in this document, including descriptions of function and schematic diagrams, shall not be construed as license of the use or exercise of any intellectual property right, such as patent right or copyright, or any other right of Fujitsu or any third party or does Fujitsu warrant non-infringement of any third-party's intellectual property right or other right by using such information. Fujitsu assumes no liability for any infringement of the intellectual property rights or other rights of third parties which would result from the use of information contained herein.

The products described in this document are designed, developed and manufactured as contemplated for general use, including without limitation, ordinary industrial use, general office use, personal use, and household use, but are not designed, developed and manufactured as contemplated (1) for use accompanying fatal risks or dangers that, unless extremely high safety is secured, could have a serious effect to the public, and could lead directly to death, personal injury, severe physical damage or other loss (i.e., nuclear reaction control in nuclear facility, aircraft flight control, air traffic control, mass transport control, medical life support system, missile launch control in weapon system), or (2) for use requiring extremely high reliability (i.e., submersible repeater and artificial satellite).

Please note that Fujitsu will not be liable against you and/or any third party for any claims or damages arising in connection with above-mentioned uses of the products.

Any semiconductor devices have an inherent chance of failure. You must protect against injury, damage or loss from such failures by incorporating safety design measures into your facility and equipment such as redundancy, fire protection, and prevention of over-current levels and other abnormal operating conditions.

If any products described in this document represent goods or technologies subject to certain restrictions on export under the Foreign Exchange and Foreign Trade Law of Japan, the prior authorization by Japanese government will be required for export of those products from Japan.

Edited Business Promotion Dept.