

FEATURES

Digitally/pin-programmable gain

$G = 1, 2, 4, 8, 16, 32, 64, \text{ or } 128$

Specified from -40°C to $+125^{\circ}\text{C}$

50 nV/ $^{\circ}\text{C}$ maximum input offset drift

10 ppm/ $^{\circ}\text{C}$ maximum gain drift

Excellent dc performance

80 dB minimum CMR, $G = 1$

15 μV maximum input offset voltage

500 pA maximum bias current

0.7 μV p-p noise (0.1 Hz to 10 Hz)

Good ac performance

2.7 MHz bandwidth, $G = 1$

1.1 V/ μs slew rate

Rail-to-rail output

Shutdown/multiplex

Extra op amp

Single-supply range: 3 V to 5 V

Dual-supply range: ± 1.5 V to ± 2.5 V

Qualified for automotive applications

APPLICATIONS

Pressure and strain transducers

Thermocouples and RTDs

Programmable instrumentation

Industrial controls

Weigh scales

Automotive controls

GENERAL DESCRIPTION

The AD8231 is a low drift, rail-to-rail, instrumentation amplifier with software-programmable gains of 1, 2, 4, 8, 16, 32, 64, or 128. The gains are programmed via digital logic or pin strapping.

The AD8231 is ideal for applications that require precision performance over a wide temperature range, such as industrial temperature sensing and data logging. Because the gain setting resistors are internal, maximum gain drift is only 10 ppm/ $^{\circ}\text{C}$ for gains of 1 to 32. Because of the auto-zero input stage, maximum input offset is 15 μV and maximum input offset drift is just 50 nV/ $^{\circ}\text{C}$. CMRR is 80 dB for $G = 1$, increasing to 110 dB at higher gains.

FUNCTIONAL BLOCK DIAGRAM

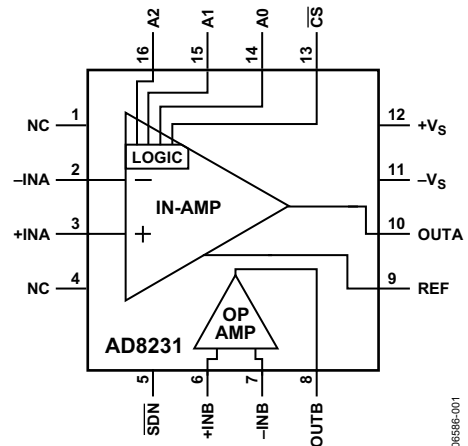

Figure 1.

Table 1. Instrumentation and Difference Amplifiers by Category

| High Performance | Low Cost | High Voltage | Mil Grade | Low Power | Digital Gain |
|---------------------|---------------------|--------------|-----------|--------------------|---------------------|
| AD8221 | AD623 ¹ | AD628 | AD620 | AD627 ¹ | AD8231 ¹ |
| AD8220 ¹ | AD8553 ¹ | AD629 | AD621 | | AD8250 |
| AD8222 | | | AD524 | | AD8251 |
| AD8224 ¹ | | | AD526 | | AD8555 ¹ |
| | | | AD624 | | AD8556 ¹ |
| | | | | | AD8557 ¹ |

¹ Rail-to-rail output.

The AD8231 also includes an uncommitted op amp that can be used for additional gain, differential signal driving, or filtering. Like the in-amp, the op amp has an auto-zero architecture, rail-to-rail input, and rail-to-rail output.

The AD8231 includes a shutdown feature that reduces current to a maximum of 1 μA . In shutdown, both amplifiers also have a high output impedance, which allows easy multiplexing of multiple amplifiers without additional switches.

The AD8231 is specified over the extended industrial temperature range of -40°C to $+125^{\circ}\text{C}$. It is available in a 4 mm \times 4 mm 16-lead LFCSP.

Rev. B

Information furnished by Analog Devices is believed to be accurate and reliable. However, no responsibility is assumed by Analog Devices for its use, nor for any infringements of patents or other rights of third parties that may result from its use. Specifications subject to change without notice. No license is granted by implication or otherwise under any patent or patent rights of Analog Devices. Trademarks and registered trademarks are the property of their respective owners.

TABLE OF CONTENTS

| | | | |
|--|----|--|----|
| Features | 1 | Gain Selection | 18 |
| Applications | 1 | Reference Terminal | 18 |
| Functional Block Diagram | 1 | Layout | 19 |
| General Description | 1 | Input Bias Current Return Path | 19 |
| Revision History | 2 | Input Protection | 19 |
| Specifications | 3 | RF Interference | 20 |
| Absolute Maximum Ratings | 7 | Common-Mode Input Voltage Range | 20 |
| Thermal Resistance | 7 | Reducing Noise | 20 |
| Maximum Power Dissipation | 7 | Applications Information | 21 |
| ESD Caution | 7 | Differential Output | 21 |
| Pin Configuration and Function Descriptions | 8 | Multiplexing | 21 |
| Typical Performance Characteristics | 9 | Using the AD8231 with Bipolar Supplies | 21 |
| Instrumentation Amplifier Performance Curves | 9 | Sallen Key Filter | 22 |
| Operational Amplifier Performance Curves | 15 | Outline Dimensions | 23 |
| Performance Curves Valid for Both Amplifiers | 17 | Ordering Guide | 23 |
| Theory of Operation | 18 | Automotive Products | 23 |
| Amplifier Architecture | 18 | | |

REVISION HISTORY

4/11—Rev. A to Rev. B

| | |
|--|----|
| Changes to Features Section and Applications Section | 1 |
| Added Exposed Pad Notation to Outline Dimensions | 23 |
| Changes to Ordering Guide | 23 |
| Added Automotive Products Section | 23 |

9/07—Rev. 0 to Rev. A

| | |
|---|----|
| Changes to Features and General Description | 1 |
| Changes to Table 2 | 3 |
| Changes to Table 3 | 5 |
| Changes to Typical Performance Characteristics Layout | 9 |
| Inserted Figure 3 to Figure 8; Renumbered Sequentially | 9 |
| Inserted Figure 9; Renumbered Sequentially | 10 |
| Inserted Figure 16, and Figure 18 to Figure 20; Renumbered Sequentially | 11 |
| Inserted Figure 24; Renumbered Sequentially | 12 |
| Deleted Figure 28 and Figure 29; Renumbered Sequentially ... | 13 |
| Inserted Figure 33 and Figure 34; Renumbered Sequentially ... | 14 |
| Inserted Figure 41 to Figure 46; Renumbered Sequentially | 16 |
| Inserted Figure 48; Renumbered Sequentially | 17 |
| Changes to Gain Selection Section and Figure 50 | 18 |
| Added Input Protection Section | 19 |
| Added Reducing Noise Section | 20 |
| Changes to Multiplexing Section | 21 |
| Added Using the AD8231 with Bipolar Supplies Section | 21 |
| Added Sallen Key Filter Section | 22 |
| Changes to Ordering Guide | 23 |

5/07—Revision 0: Initial Version

SPECIFICATIONS

$V_S = 5\text{ V}$, $V_{REF} = 2.5\text{ V}$, $G = 1$, $R_L = 10\text{ k}\Omega$, $T_A = 25^\circ\text{C}$, unless otherwise noted.

Table 2.

| Parameter | Conditions | Min | Typ | Max | Unit |
|----------------------------------|--|------|-------|------|------------------------------|
| INSTRUMENTATION AMPLIFIER | | | | | |
| Offset Voltage | $V_{OS\ RTI} = V_{OSI} + V_{OSO}/G$ | | | | |
| Input Offset, V_{OSI} | | | 4 | 15 | μV |
| Average Temperature Drift | $T_A = -40^\circ\text{C}$ to $+125^\circ\text{C}$ | | 0.01 | 0.05 | $\mu\text{V}/^\circ\text{C}$ |
| Output Offset, V_{OSO} | | | 15 | 30 | μV |
| Average Temperature Drift | $T_A = -40^\circ\text{C}$ to $+125^\circ\text{C}$ | | 0.05 | 0.5 | $\mu\text{V}/^\circ\text{C}$ |
| Input Currents | | | | | |
| Input Bias Current | | | 250 | 500 | pA |
| Input Offset Current | $T_A = -40^\circ\text{C}$ to $+125^\circ\text{C}$ | | | 5 | nA |
| | $T_A = -40^\circ\text{C}$ to $+125^\circ\text{C}$ | | 20 | 100 | pA |
| | $T_A = -40^\circ\text{C}$ to $+125^\circ\text{C}$ | | | 0.5 | nA |
| Gains | 1, 2, 4, 8, 16, 32, 64, or 128 | | | | |
| Gain Error | | | | | |
| G = 1 | | | | 0.05 | % |
| G = 2 to 128 | | | | 0.8 | % |
| Gain Drift | $T_A = -40^\circ\text{C}$ to $+125^\circ\text{C}$ | | | | |
| G = 1 to 32 | | | 3 | 10 | ppm/ $^\circ\text{C}$ |
| G = 64 | | | 4 | 20 | ppm/ $^\circ\text{C}$ |
| G = 128 | | | 10 | 30 | ppm/ $^\circ\text{C}$ |
| Linearity | 0.2 V to 4.8 V, 10 k Ω load | | 3 | | ppm |
| | 0.2 V to 4.8 V, 2 k Ω load | | 5 | | ppm |
| CMRR | | | | | |
| G = 1 | | 80 | | | dB |
| G = 2 | | 86 | | | dB |
| G = 4 | | 92 | | | dB |
| G = 8 | | 98 | | | dB |
| G = 16 | | 104 | | | dB |
| G = 32 | | 110 | | | dB |
| G = 64 | | 110 | | | dB |
| G = 128 | | 110 | | | dB |
| Noise | $e_n = \sqrt{(e_{ni}^2 + (e_{no}/G)^2)}$, $V_{IN+}, V_{IN-} = 2.5\text{ V}$ | | | | |
| Input Voltage Noise, e_{ni} | f = 1 kHz | | 32 | | nV/ $\sqrt{\text{Hz}}$ |
| | f = 1 kHz, $T_A = -40^\circ\text{C}$ | | 27 | | nV/ $\sqrt{\text{Hz}}$ |
| | f = 1 kHz, $T_A = 125^\circ\text{C}$ | | 39 | | nV/ $\sqrt{\text{Hz}}$ |
| Output Voltage Noise, e_{no} | f = 0.1 Hz to 10 Hz | | 0.7 | | $\mu\text{V p-p}$ |
| | f = 1 kHz | | 58 | | nV/ $\sqrt{\text{Hz}}$ |
| | f = 1 kHz, $T_A = -40^\circ\text{C}$ | | 50 | | nV/ $\sqrt{\text{Hz}}$ |
| | f = 1 kHz, $T_A = 125^\circ\text{C}$ | | 70 | | nV/ $\sqrt{\text{Hz}}$ |
| | f = 0.1 Hz to 10 Hz | | 1.1 | | $\mu\text{V p-p}$ |
| Current Noise | f = 10 Hz | | 20 | | fA/ $\sqrt{\text{Hz}}$ |
| Other Input Characteristics | | | | | |
| Common-Mode Input Impedance | | | 10 5 | | G Ω pF |
| Power Supply Rejection Ratio | | 100 | 115 | | dB |
| Input Operating Voltage Range | | 0.05 | | 4.95 | V |
| Reference Input | | | | | |
| Input Impedance | | | 28 | | k Ω |
| Voltage Range | | -0.2 | | +5.2 | V |

AD8231

| Parameter | Conditions | Min | Typ | Max | Unit |
|---|---|------|------|------|---------------------------|
| Dynamic Performance | | | | | |
| Bandwidth | | | | | |
| G = 1 | | | 2.7 | | MHz |
| G = 2 | | | 2.5 | | MHz |
| Gain Bandwidth Product | | | | | |
| G = 4 to 128 | | | 7 | | MHz |
| Slew Rate | | | 1.1 | | V/ μ s |
| Output Characteristics | | | | | |
| Output Voltage High | $R_L = 100\text{ k}\Omega$ to ground | 4.9 | 4.94 | | V |
| | $R_L = 10\text{ k}\Omega$ to ground | 4.8 | 4.88 | | V |
| Output Voltage Low | $R_L = 100\text{ k}\Omega$ to 5 V | | 60 | 100 | mV |
| | $R_L = 10\text{ k}\Omega$ to 5 V | | 80 | 200 | mV |
| Short-Circuit Current | | | 70 | | mA |
| Digital Interface | | | | | |
| Input Voltage Low | $T_A = -40^\circ\text{C}$ to $+125^\circ\text{C}$ | | | 1.0 | V |
| Input Voltage High | $T_A = -40^\circ\text{C}$ to $+125^\circ\text{C}$ | 4.0 | | | V |
| Setup Time to $\overline{\text{CS}}$ High | $T_A = -40^\circ\text{C}$ to $+125^\circ\text{C}$ | 50 | | | ns |
| Hold Time after $\overline{\text{CS}}$ High | $T_A = -40^\circ\text{C}$ to $+125^\circ\text{C}$ | 20 | | | ns |
| OPERATIONAL AMPLIFIER | | | | | |
| Input Characteristics | | | | | |
| Offset Voltage, V_{OS} | | | 5 | 15 | μ V |
| Temperature Drift | $T_A = -40^\circ\text{C}$ to $+125^\circ\text{C}$ | | 0.01 | 0.06 | μ V/ $^\circ\text{C}$ |
| Input Bias Current | | | 250 | 500 | pA |
| | $T_A = -40^\circ\text{C}$ to $+125^\circ\text{C}$ | | | 5 | nA |
| Input Offset Current | | | 20 | 100 | pA |
| | $T_A = -40^\circ\text{C}$ to $+125^\circ\text{C}$ | | | 0.5 | nA |
| Input Voltage Range | | 0.05 | | 4.95 | V |
| Open-Loop Gain | | 100 | 120 | | V/mV |
| Common-Mode Rejection Ratio | | 100 | 120 | | dB |
| Power Supply Rejection Ratio | | 100 | 110 | | dB |
| Voltage Noise Density | | | 20 | | nV/ $\sqrt{\text{Hz}}$ |
| Voltage Noise | $f = 0.1\text{ Hz}$ to 10 Hz | | 0.4 | | μ V p-p |
| Dynamic Performance | | | | | |
| Gain Bandwidth Product | | | 1 | | MHz |
| Slew Rate | | | 0.5 | | V/ μ s |
| Output Characteristics | | | | | |
| Output Voltage High | $R_L = 100\text{ k}\Omega$ to ground | 4.9 | 4.96 | | V |
| | $R_L = 10\text{ k}\Omega$ to ground | 4.8 | 4.92 | | V |
| Output Voltage Low | $R_L = 100\text{ k}\Omega$ to 5 V | | 60 | 100 | mV |
| | $R_L = 10\text{ k}\Omega$ to 5 V | | 80 | 200 | mV |
| Short-Circuit Current | | | 70 | | mA |
| BOTH AMPLIFIERS | | | | | |
| Power Supply | | | | | |
| Quiescent Current | | | 4 | 5 | mA |
| Quiescent Current (Shutdown) | | | 0.01 | 1 | μ A |

$V_S = 3.0\text{ V}$, $V_{REF} = 1.5\text{ V}$, $T_A = 25^\circ\text{C}$, $G = 1$, $R_L = 10\text{ k}\Omega$, unless otherwise noted.

Table 3.

| Parameter | Conditions | Min | Typ | Max | Unit |
|----------------------------------|--|------|-------|------|------------------------------|
| INSTRUMENTATION AMPLIFIER | | | | | |
| Offset Voltage | $V_{OS\ RTI} = V_{OSI} + V_{OSO}/G$ | | | | |
| Input Offset, V_{OSI} | | | 4 | 15 | μV |
| Average Temperature Drift | | | 0.01 | 0.05 | $\mu\text{V}/^\circ\text{C}$ |
| Output Offset, V_{OSO} | | | 15 | 30 | μV |
| Average Temperature Drift | | | 0.05 | 0.5 | $\mu\text{V}/^\circ\text{C}$ |
| Input Currents | | | | | |
| Input Bias Current | | | 250 | 500 | pA |
| Input Offset Current | $T_A = -40^\circ\text{C}$ to $+125^\circ\text{C}$ | | 20 | 100 | pA |
| | $T_A = -40^\circ\text{C}$ to $+125^\circ\text{C}$ | | | 0.5 | nA |
| Gains | 1, 2, 4, 8, 16, 32, 64, or 128 | | | | |
| Gain Error | | | | | |
| $G = 1$ | | | | 0.05 | % |
| $G = 2$ to 128 | | | | 0.8 | % |
| Gain Drift | $T_A = -40^\circ\text{C}$ to $+125^\circ\text{C}$ | | | | |
| $G = 1$ to 32 | | | 3 | 10 | $\text{ppm}/^\circ\text{C}$ |
| $G = 64$ | | | 4 | 20 | $\text{ppm}/^\circ\text{C}$ |
| $G = 128$ | | | 10 | 30 | $\text{ppm}/^\circ\text{C}$ |
| CMRR | | | | | |
| $G = 1$ | | 80 | | | dB |
| $G = 2$ | | 86 | | | dB |
| $G = 4$ | | 92 | | | dB |
| $G = 8$ | | 98 | | | dB |
| $G = 16$ | | 104 | | | dB |
| $G = 32$ | | 110 | | | dB |
| $G = 64$ | | 110 | | | dB |
| $G = 128$ | | 110 | | | dB |
| Noise | $e_n = \sqrt{(e_{ni})^2 + (e_{no}/G)^2}$ $V_{IN+}, V_{IN-} = 2.5\text{ V}$, $T_A = 25^\circ\text{C}$ | | | | |
| Input Voltage Noise, e_{ni} | $f = 1\text{ kHz}$ | | 40 | | $\text{nV}/\sqrt{\text{Hz}}$ |
| | $f = 1\text{ kHz}$, $T_A = -40^\circ\text{C}$ | | 35 | | $\text{nV}/\sqrt{\text{Hz}}$ |
| | $f = 1\text{ kHz}$, $T_A = 125^\circ\text{C}$ | | 48 | | $\text{nV}/\sqrt{\text{Hz}}$ |
| Output Voltage Noise, e_{no} | $f = 0.1\text{ Hz}$ to 10 Hz | | 0.8 | | $\mu\text{V p-p}$ |
| | $f = 1\text{ kHz}$ | | 72 | | $\text{nV}/\sqrt{\text{Hz}}$ |
| | $f = 1\text{ kHz}$, $T_A = -40^\circ\text{C}$ | | 62 | | $\text{nV}/\sqrt{\text{Hz}}$ |
| | $f = 1\text{ kHz}$, $T_A = 125^\circ\text{C}$ | | 83 | | $\text{nV}/\sqrt{\text{Hz}}$ |
| | $f = 0.1\text{ Hz}$ to 10 Hz | | 1.4 | | $\mu\text{V p-p}$ |
| Current Noise | $f = 10\text{ Hz}$ | | 20 | | $\text{fA}/\sqrt{\text{Hz}}$ |
| Other Input Characteristics | | | | | |
| Common-Mode Input Impedance | | | 10 5 | | $\text{G}\Omega \text{pF}$ |
| Power Supply Rejection Ratio | | 100 | 115 | | dB |
| Input Operating Voltage Range | | 0.05 | | 2.95 | V |
| Reference Input | | | | | |
| Input Impedance | | | 28 | | $\text{k}\Omega \text{pF}$ |
| Voltage Range | | -0.2 | | +3.2 | V |

AD8231

| Parameter | Conditions | Min | Typ | Max | Unit |
|---|---|------|------|------|--------|
| Dynamic Performance | | | | | |
| Bandwidth | | | | | |
| G = 1 | | | 2.7 | | MHz |
| G = 2 | | | 2.5 | | MHz |
| Gain Bandwidth Product | | | | | |
| G = 4 to 128 | | | 7 | | MHz |
| Slew Rate | | | 1.1 | | V/μs |
| Output Characteristics | | | | | |
| Output Voltage High | $R_L = 100\text{ k}\Omega$ to ground | 2.9 | 2.94 | | V |
| | $R_L = 10\text{ k}\Omega$ to ground | 2.8 | 2.88 | | V |
| Output Voltage Low | $R_L = 100\text{ k}\Omega$ to 3 V | | 60 | 100 | mV |
| | $R_L = 10\text{ k}\Omega$ to 3 V | | 80 | 200 | mV |
| Short-Circuit Current | | | 40 | | mA |
| Digital Interface | | | | | |
| Input Voltage Low | $T_A = -40^\circ\text{C}$ to $+125^\circ\text{C}$ | | | 0.7 | V |
| Input Voltage High | $T_A = -40^\circ\text{C}$ to $+125^\circ\text{C}$ | 2.3 | | | V |
| Setup Time to $\overline{\text{CS}}$ High | $T_A = -40^\circ\text{C}$ to $+125^\circ\text{C}$ | 60 | | | ns |
| Hold Time after $\overline{\text{CS}}$ High | $T_A = -40^\circ\text{C}$ to $+125^\circ\text{C}$ | 20 | | | ns |
| OPERATIONAL AMPLIFIERS | | | | | |
| Input Characteristics | | | | | |
| Offset Voltage, V_{os} | | | 5 | 15 | μV |
| Temperature Drift | $T_A = -40^\circ\text{C}$ to $+125^\circ\text{C}$ | | 0.01 | 0.06 | μV/°C |
| Input Bias Current | | | 250 | 500 | pA |
| | $T_A = -40^\circ\text{C}$ to $+125^\circ\text{C}$ | | | 5 | nA |
| Input Offset Current | | | 20 | 100 | pA |
| | $T_A = -40^\circ\text{C}$ to $+125^\circ\text{C}$ | | | 0.5 | nA |
| Input Voltage Range | | 0.05 | | 2.95 | V |
| Open-Loop Gain | | 100 | 120 | | V/mV |
| Common-Mode Rejection Ratio | | 100 | 120 | | dB |
| Power Supply Rejection Ratio | | 100 | 110 | | dB |
| Voltage Noise Density | | | 27 | | nV/√Hz |
| Voltage Noise | $f = 0.1\text{ Hz}$ to 10 Hz | | 0.6 | | μV p-p |
| Dynamic Performance | | | | | |
| Gain Bandwidth Product | | | 1 | | MHz |
| Slew Rate | | | 0.5 | | V/μs |
| Output Characteristics | | | | | |
| Output Voltage High | $R_L = 100\text{ k}\Omega$ to ground | 2.9 | 2.96 | | V |
| | $R_L = 10\text{ k}\Omega$ to ground | 2.8 | 2.82 | | V |
| Output Voltage Low | $R_L = 100\text{ k}\Omega$ to 3 V | | 60 | 100 | mV |
| | $R_L = 10\text{ k}\Omega$ to 3 V | | 80 | 200 | mV |
| Short-Circuit Current | | | 40 | | mA |
| BOTH AMPLIFIERS | | | | | |
| Power Supply | | | | | |
| Quiescent Current | | | 3.5 | 4.5 | mA |
| Quiescent Current (Shutdown) | | | 0.01 | 1 | μA |

ABSOLUTE MAXIMUM RATINGS

Table 4.

| Parameter | Rating |
|--------------------------------------|--|
| Supply Voltage | 6 V |
| Output Short-Circuit Current | Indefinite ¹ |
| Input Voltage (Common-Mode) | $-V_S - 0.3 \text{ V}$ to $+V_S + 0.3 \text{ V}$ |
| Differential Input Voltage | $-V_S - 0.3 \text{ V}$ to $+V_S + 0.3 \text{ V}$ |
| Storage Temperature Range | -65°C to $+150^\circ\text{C}$ |
| Operational Temperature Range | -40°C to $+125^\circ\text{C}$ |
| Package Glass Transition Temperature | 130°C |
| ESD (Human Body Model) | 1.5 kV |
| ESD (Charged Device Model) | 1.5 kV |
| ESD (Machine Model) | 0.2 kV |

¹ For junction temperatures between 105°C and 130°C, short-circuit operation beyond 1000 hours can impact part reliability.

Stresses above those listed under Absolute Maximum Ratings may cause permanent damage to the device. This is a stress rating only; functional operation of the device at these or any other conditions above those indicated in the operational section of this specification is not implied. Exposure to absolute maximum rating conditions for extended periods may affect device reliability.

THERMAL RESISTANCE

Table 5.

| Thermal Pad | θ_{JA} | Unit |
|-----------------------|---------------|---------------------------|
| Soldered to Board | 54 | $^\circ\text{C}/\text{W}$ |
| Not Soldered to Board | 96 | $^\circ\text{C}/\text{W}$ |

The θ_{JA} values in Table 5 assume a 4-layer JEDEC standard board. If the thermal pad is soldered to the board, it is also assumed it is connected to a plane. θ_{JC} at the exposed pad is 6.3°C/W.

MAXIMUM POWER DISSIPATION

The maximum safe power dissipation for the AD8231 is limited by the associated rise in junction temperature (T_J) on the die. At approximately 130°C, which is the glass transition temperature, the plastic changes its properties. Even temporarily exceeding this temperature limit may change the stresses that the package exerts on the die, permanently shifting the parametric performance of the amplifiers. Exceeding a temperature of 130°C for an extended period can result in a loss of functionality.

ESD CAUTION



ESD (electrostatic discharge) sensitive device. Charged devices and circuit boards can discharge without detection. Although this product features patented or proprietary protection circuitry, damage may occur on devices subjected to high energy ESD. Therefore, proper ESD precautions should be taken to avoid performance degradation or loss of functionality.

PIN CONFIGURATION AND FUNCTION DESCRIPTIONS

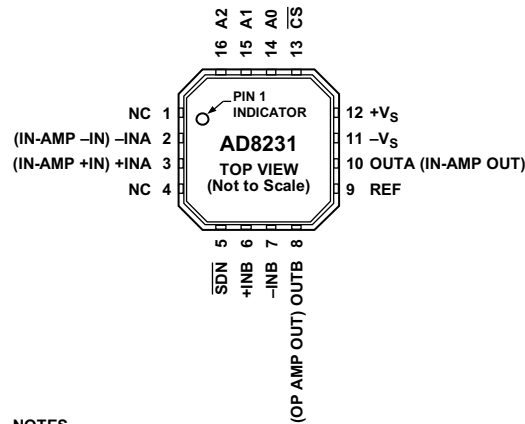

NOTES

1. NC = NO CONNECT.
2. THE EXPOSED PAD CAN BE CONNECTED TO THE NEGATIVE SUPPLY ($-V_S$) OR LEFT FLOATING.

06586-002

Figure 2. Pin Configuration

Table 6. Pin Function Descriptions

| Pin Number | Mnemonic | Description |
|------------|-------------------------|--|
| 1 | NC | No Connect. |
| 2 | -INA (IN-AMP -IN) | Instrumentation Amplifier Negative Input. |
| 3 | +INA (IN-AMP +IN) | Instrumentation Amplifier Positive Input. |
| 4 | NC | No Connect. |
| 5 | $\overline{\text{SDN}}$ | Shutdown. |
| 6 | +INB | Operational Amplifier Positive Input. |
| 7 | -INB | Operational Amplifier Negative Input. |
| 8 | OUTB (OP AMP OUT) | Operational Amplifier Output. |
| 9 | REF | Instrumentation Amplifier Reference Pin. It should be driven with a low impedance. Output is referred to this pin. |
| 10 | OUTA (IN-AMP OUT) | Instrumentation Amplifier Output. |
| 11 | $-V_S$ | Negative Power Supply. Connect to ground in single-supply applications. |
| 12 | $+V_S$ | Positive Power Supply. |
| 13 | CS | Chip Select. Enables digital logic interface. |
| 14 | A0 | Gain Setting Bit (LSB). |
| 15 | A1 | Gain Setting Bit. |
| 16 | A2 | Gain Setting Bit (MSB). |
| | EPAD | Exposed Pad. Can be connected to the negative supply ($-V_S$) or left floating. |

TYPICAL PERFORMANCE CHARACTERISTICS

INSTRUMENTATION AMPLIFIER PERFORMANCE CURVES

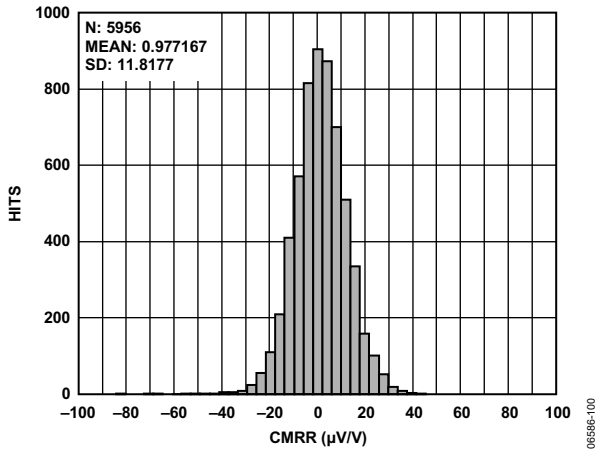

Figure 3. Instrumentation Amplifier CMR Distribution, G = 1

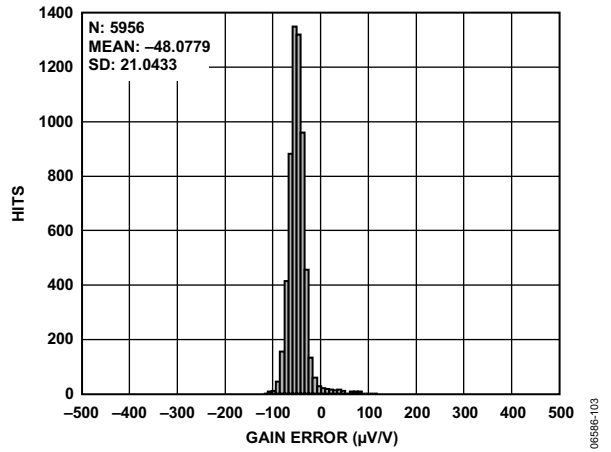

Figure 6. Instrumentation Amplifier Gain Distribution, G = 1

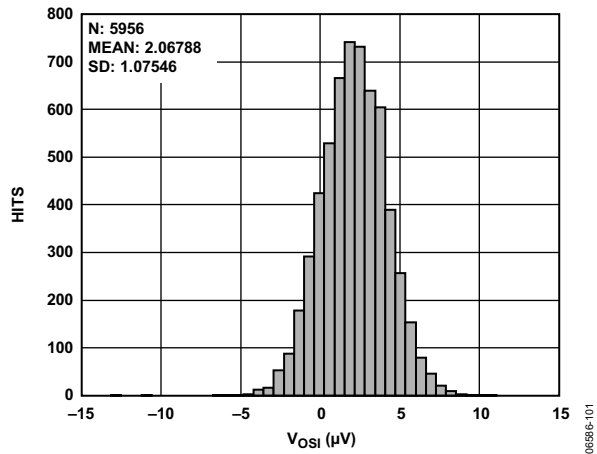

Figure 4. Instrumentation Amplifier Input Offset Voltage Distribution

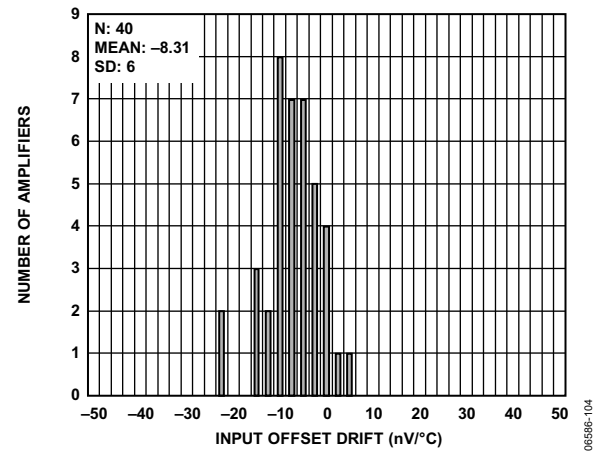

Figure 7. Instrumentation Amplifier Input Offset Voltage Drift, -40°C to +125°C

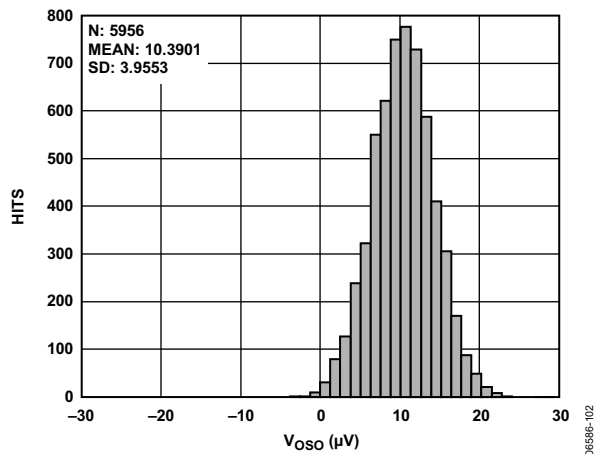

Figure 5. Instrumentation Amplifier Output Offset Voltage Distribution

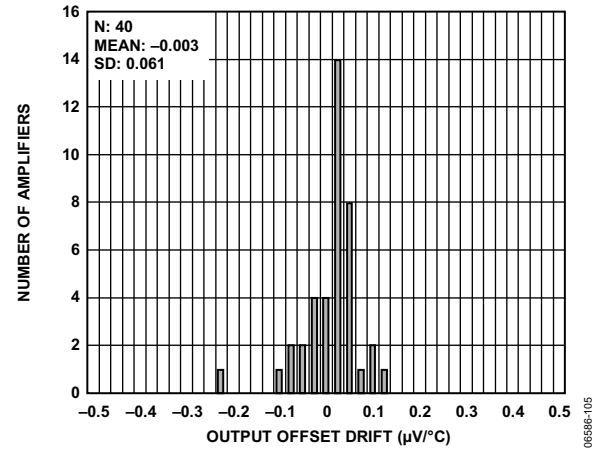

Figure 8. Instrumentation Amplifier Output Offset Drift, -40°C to +125°C

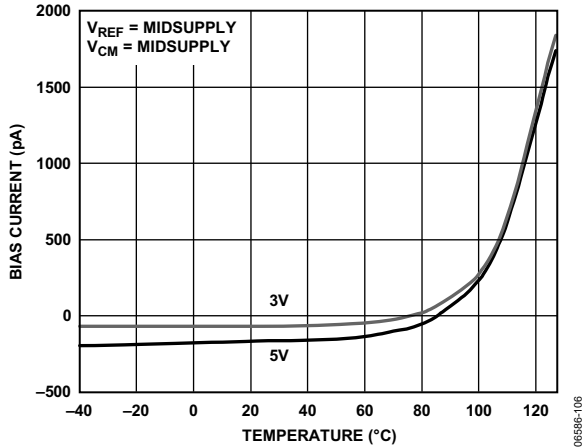

Figure 9. Instrumentation Amplifier Bias Current vs. Temperature

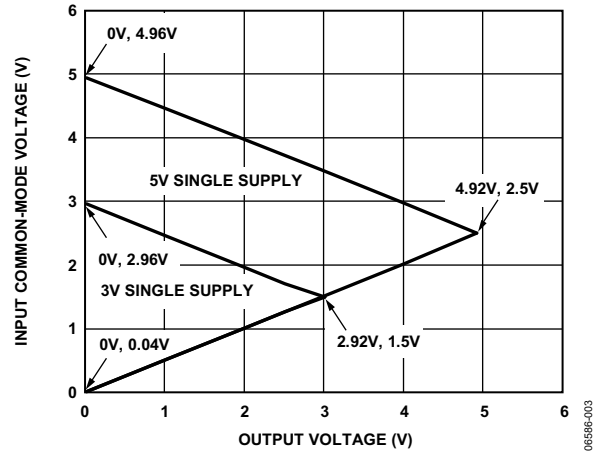

Figure 12. Instrumentation Amplifier Input Common-Mode Range vs. Output Voltage, $V_{REF} = 0\text{ V}$

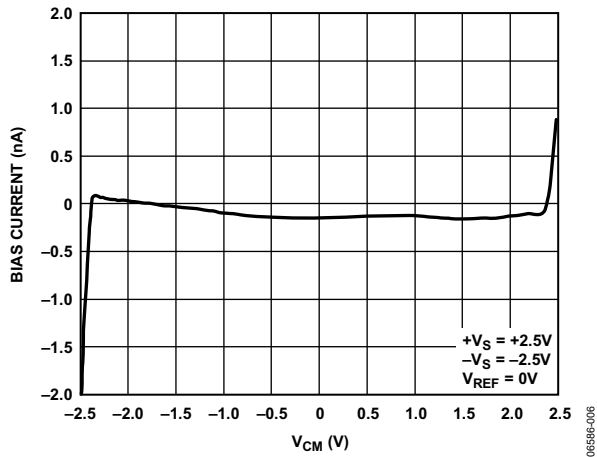

Figure 10. Instrumentation Amplifier Bias Current vs. Common-Mode Voltage, 5 V

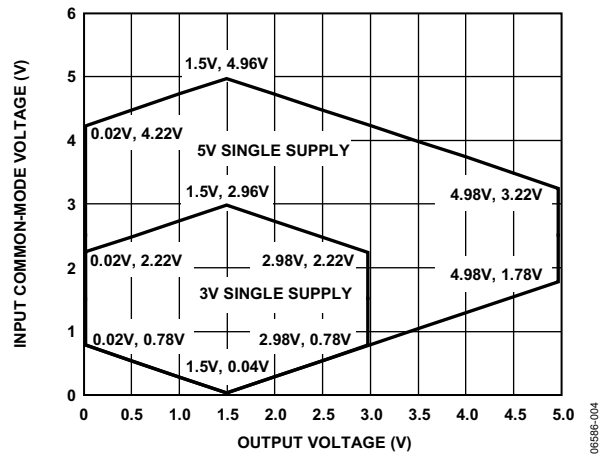

Figure 13. Instrumentation Amplifier Input Common-Mode Range vs. Output Voltage, $V_{REF} = 1.5\text{ V}$

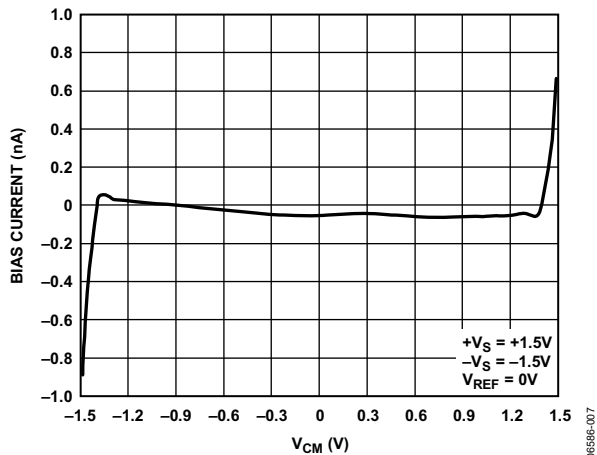

Figure 11. Instrumentation Amplifier Bias Current vs. Common-Mode Voltage, 3 V

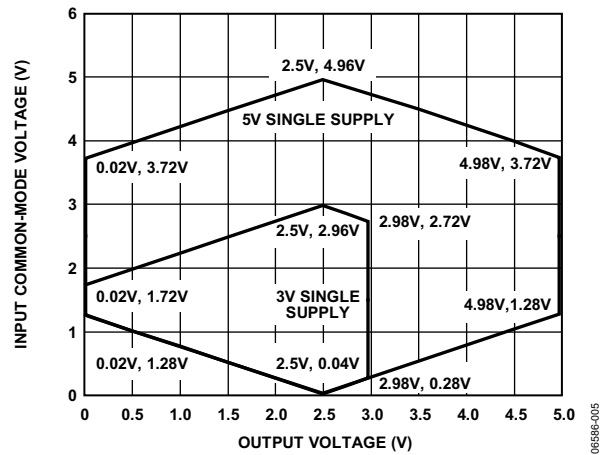

Figure 14. Instrumentation Amplifier Input Common-Mode Range vs. Output Voltage, $V_{REF} = 2.5\text{ V}$

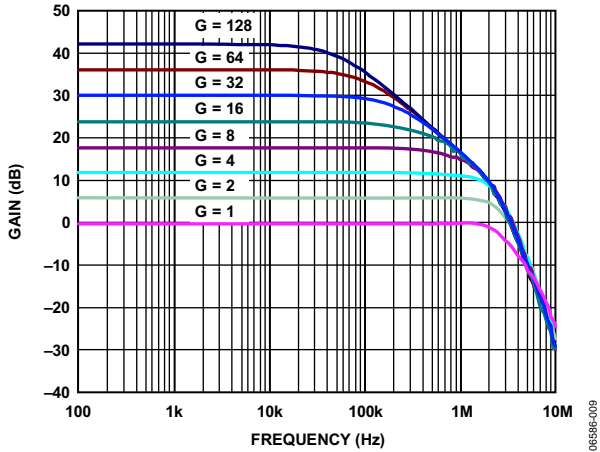

Figure 15. Instrumentation Amplifier Gain vs. Frequency

06596-009

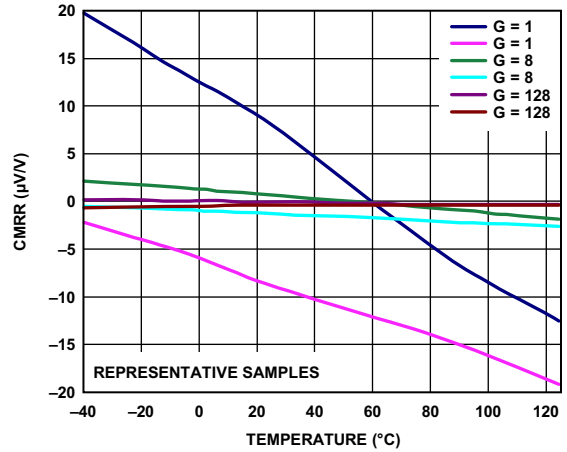

Figure 18. Instrumentation Amplifier CMRR vs. Temperature

06596-118

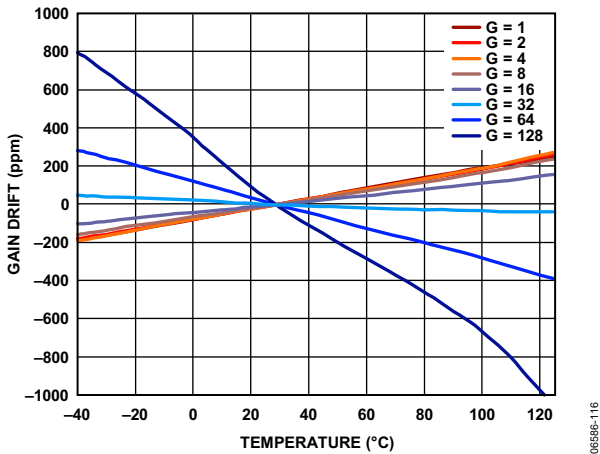

Figure 16. Instrumentation Amplifier Gain Drift vs. Temperature

06596-116

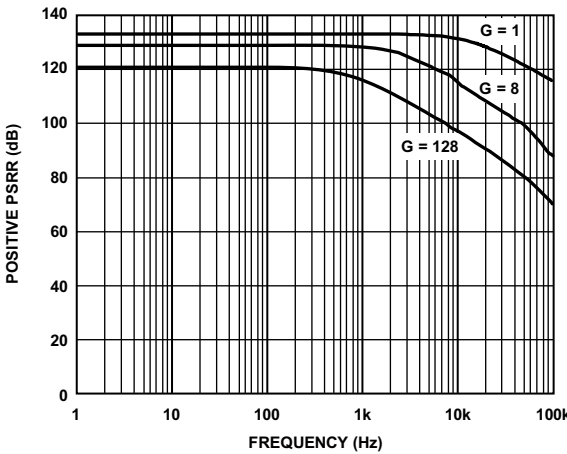

Figure 19. Instrumentation Amplifier Positive PSRR vs. Frequency

06596-146

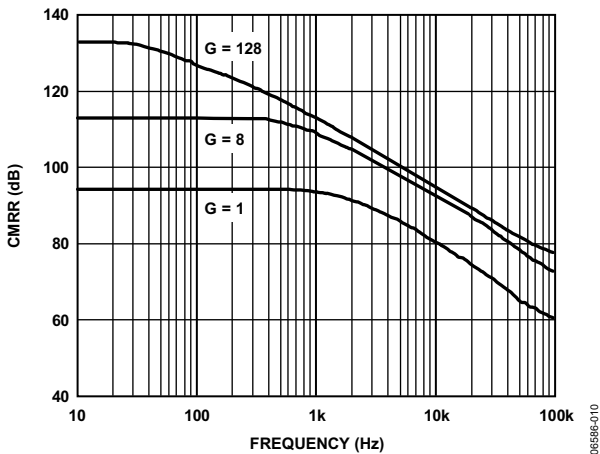

Figure 17. Instrumentation Amplifier CMRR vs. Frequency

06596-010

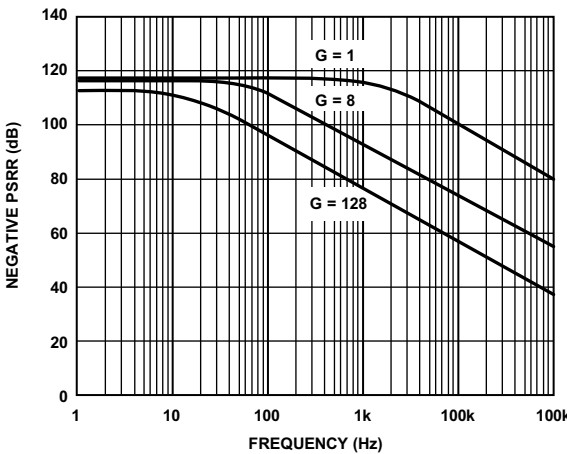

Figure 20. Instrumentation Amplifier Negative PSRR vs. Frequency

06596-147

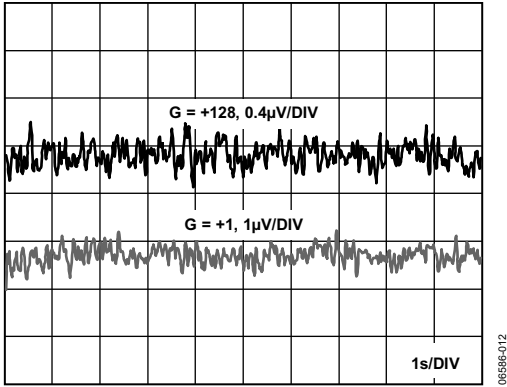

Figure 21. Instrumentation Amplifier 0.1 Hz to 10 Hz Noise

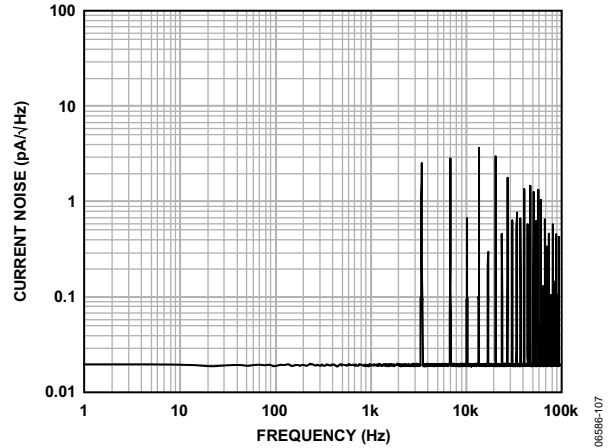

Figure 24. Instrumentation Amplifier Current Noise Spectral Density

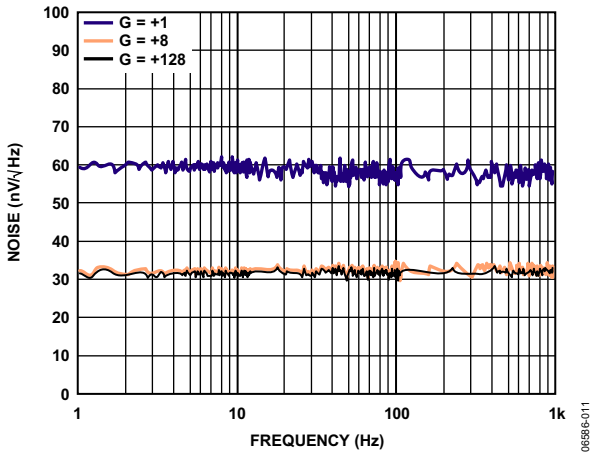

Figure 22. Instrumentation Amplifier Voltage Noise Spectral Density vs. Frequency, 5 V, 1 Hz to 1000 Hz

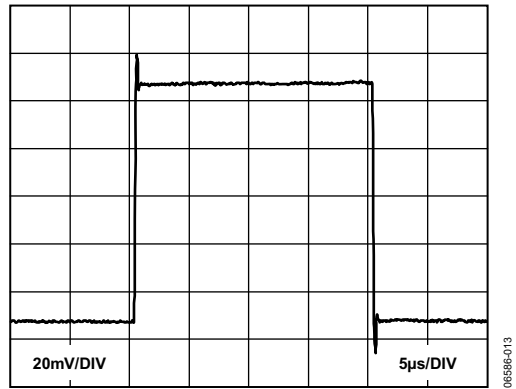

Figure 25. Instrumentation Amplifier Small Signal Pulse Response, $G = 1$, $R_L = 2\text{ k}\Omega$, $C_L = 500\text{ pF}$

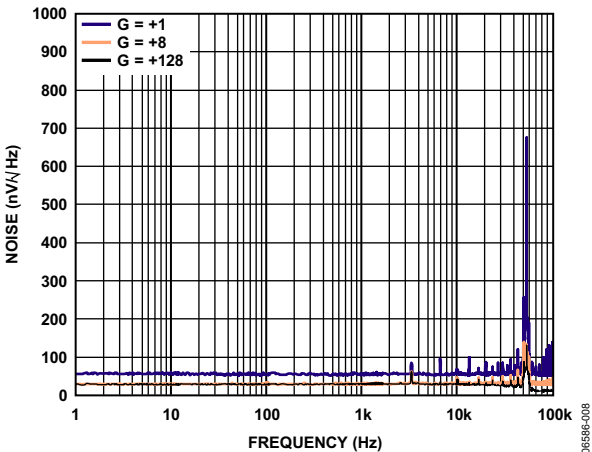

Figure 23. Instrumentation Amplifier Voltage Noise Spectral Density vs. Frequency, 5 V, 1 Hz to 1 MHz

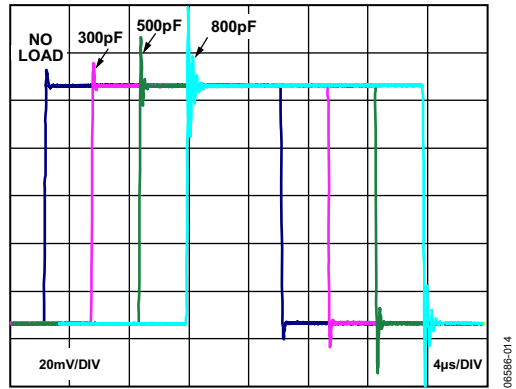

Figure 26. Instrumentation Amplifier Small Signal Pulse Response for Various Capacitive Loads, $G = 1$

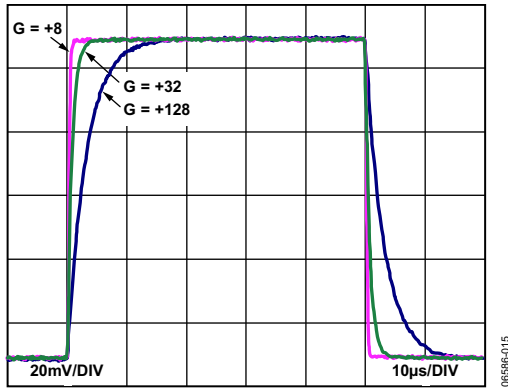

Figure 27. Instrumentation Amplifier Small Signal Pulse Response, $G = 4, 16,$ and $128, R_L = 2\text{ k}\Omega, C_L = 500\text{ pF}$

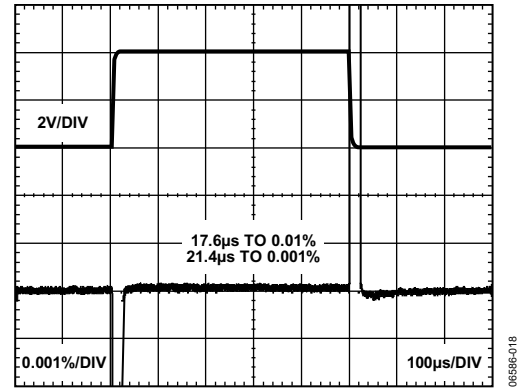

Figure 30. Instrumentation Amplifier Large Signal Pulse Response, $G = 128, V_S = 5\text{ V}$

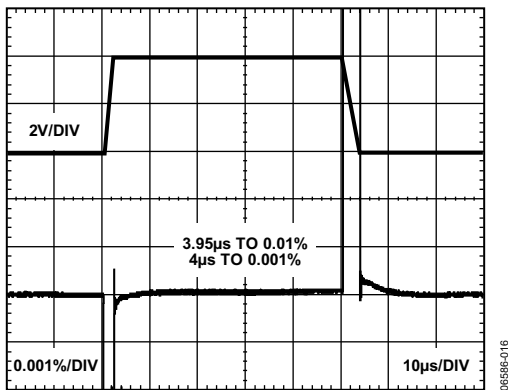

Figure 28. Instrumentation Amplifier Large Signal Pulse Response, $G = 1, V_S = 5\text{ V}$

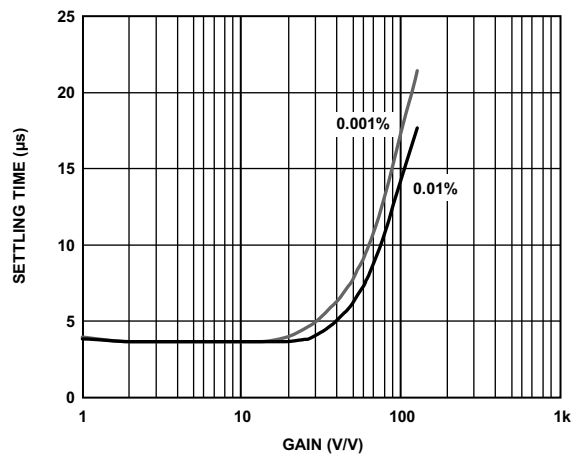

Figure 31. Instrumentation Amplifier Settling Time vs. Gain for a $4\text{ V p-p Step}, V_S = 5\text{ V}$

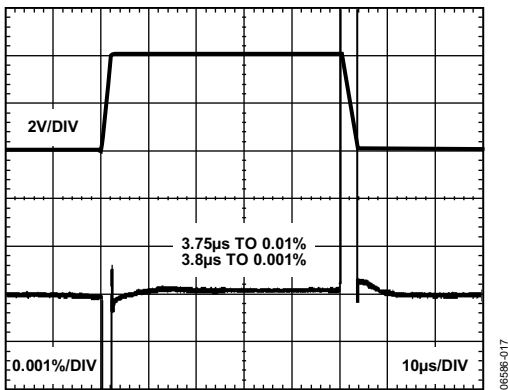

Figure 29. Instrumentation Amplifier Large Signal Pulse Response, $G = 8, V_S = 5\text{ V}$

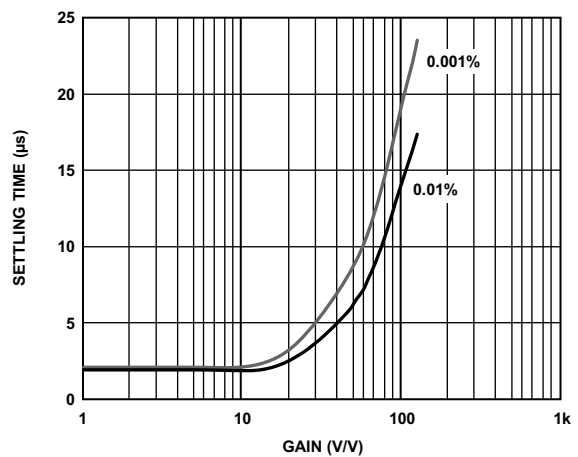

Figure 32. Instrumentation Amplifier Settling Time vs. Gain for a $2\text{ V p-p Step}, V_S = 3\text{ V}$

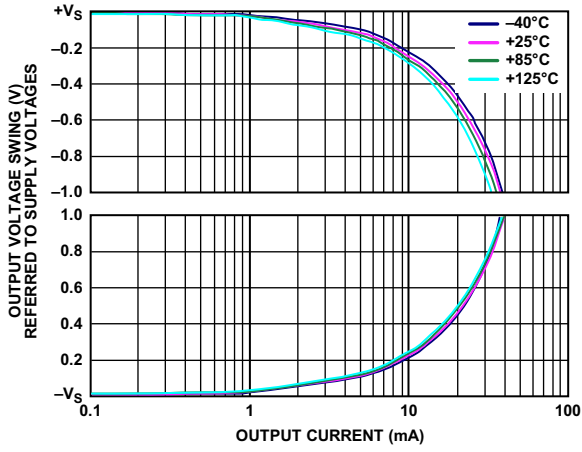

Figure 33. Instrumentation Amplifier Output Voltage Swing vs. Output Current, $V_S = 3\text{ V}$

06586-133

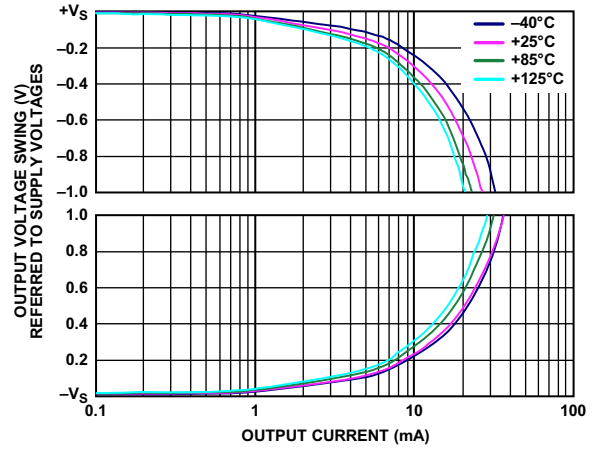

Figure 34. Instrumentation Amplifier Output Voltage Swing vs. Output Current, $V_S = 5\text{ V}$

06586-134

OPERATIONAL AMPLIFIER PERFORMANCE CURVES

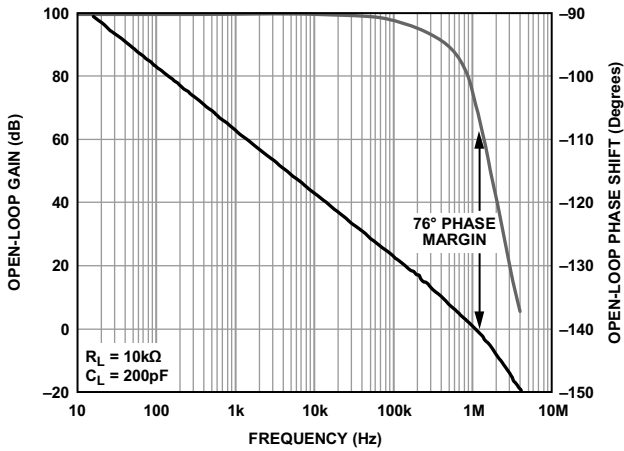

Figure 35. Operational Amplifier Open-Loop Gain and Phase vs. Frequency, $V_S = 5\text{ V}$

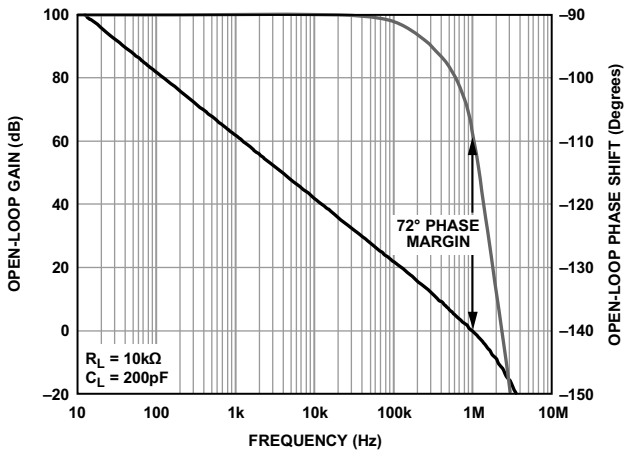

Figure 36. Operational Amplifier Open-Loop Gain and Phase vs. Frequency, $V_S = 3\text{ V}$

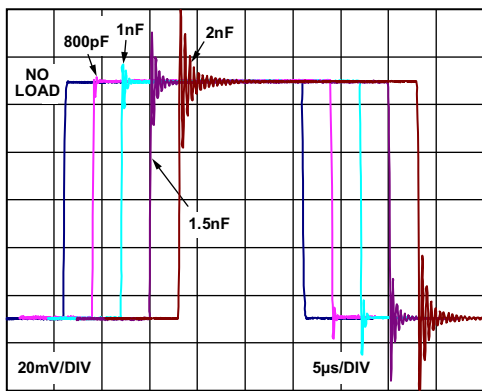

Figure 37. Operational Amplifier Small Signal Response for Various Capacitive Loads, $V_S = 5\text{ V}$

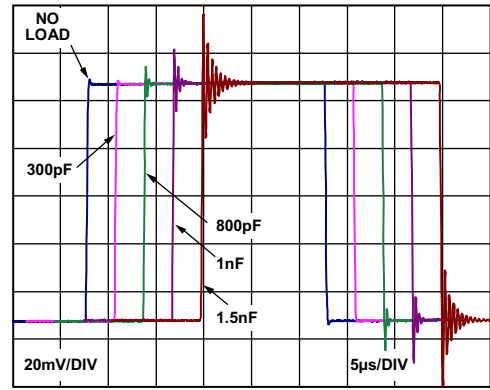

Figure 38. Operational Amplifier Small Signal Response for Various Capacitive Loads, $V_S = 3\text{ V}$

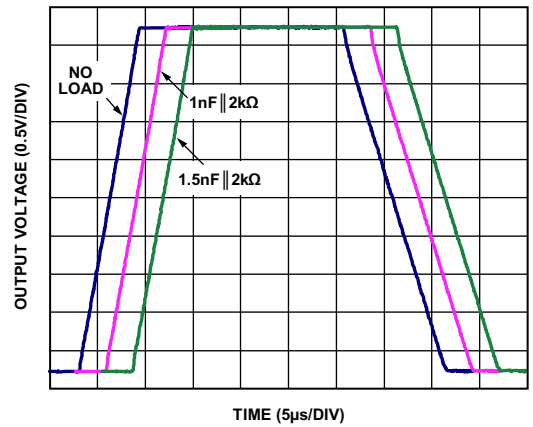

Figure 39. Operational Amplifier Large Signal Transient Response, $V_S = 5\text{ V}$

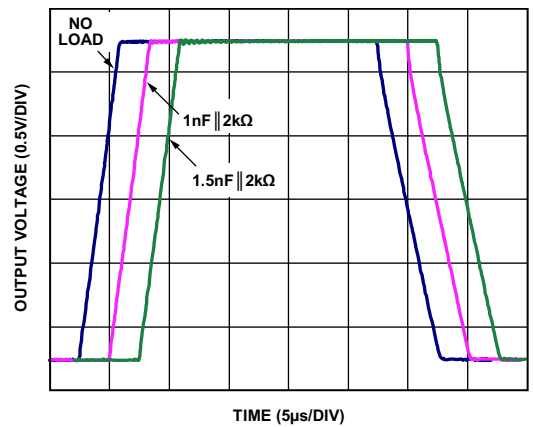

Figure 40. Operational Amplifier Large Signal Transient Response, $V_S = 3\text{ V}$

AD8231

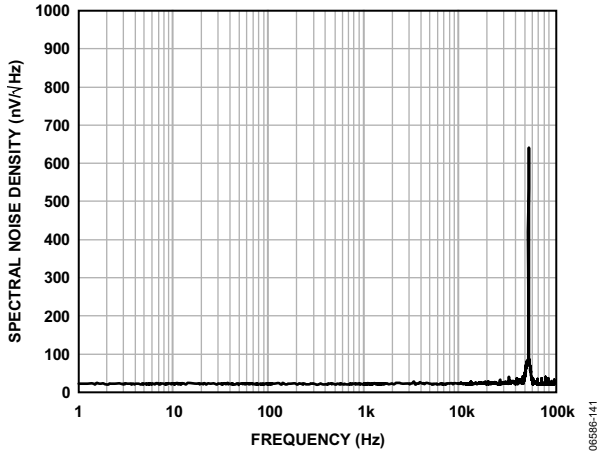

Figure 41. Operational Amplifier Voltage Spectral Noise Density vs. Frequency

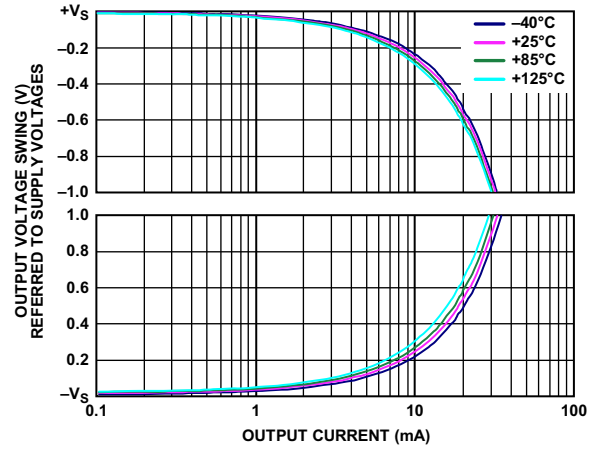

Figure 44. Operational Amplifier Output Voltage Swing vs. Output Current, $V_S = 3\text{ V}$

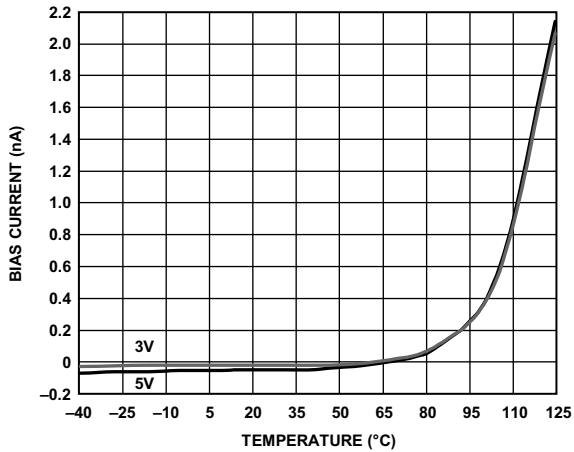

Figure 42. Operational Amplifier Bias Current vs. Temperature

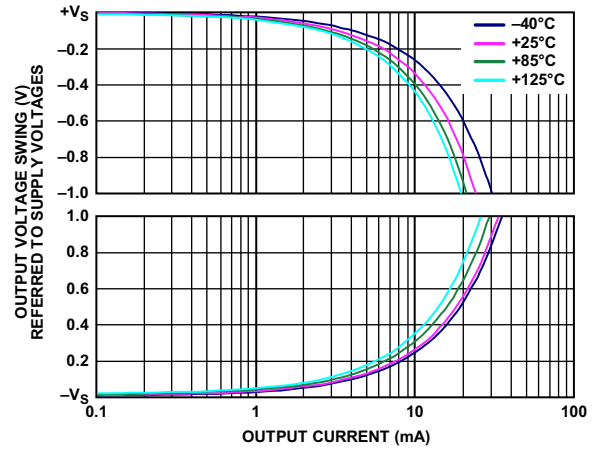

Figure 45. Operational Amplifier Output Voltage Swing vs. Output Current, $V_S = 5\text{ V}$

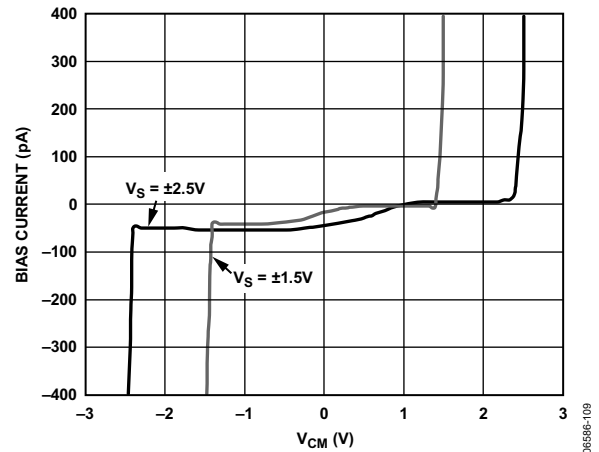

Figure 43. Operational Amplifier Bias Current vs. Common Mode

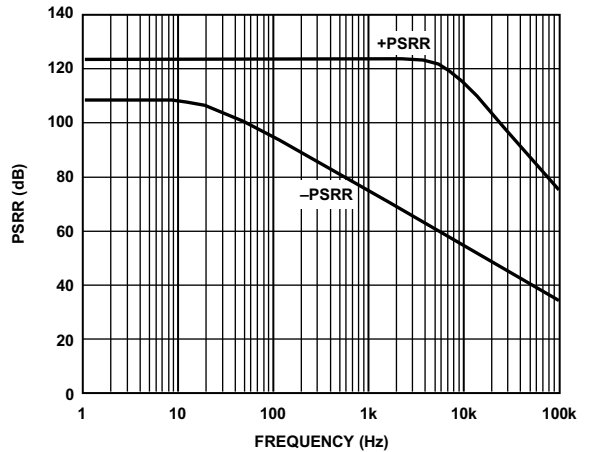

Figure 46. Operational Amplifier Power Supply Rejection Ratio

PERFORMANCE CURVES VALID FOR BOTH AMPLIFIERS

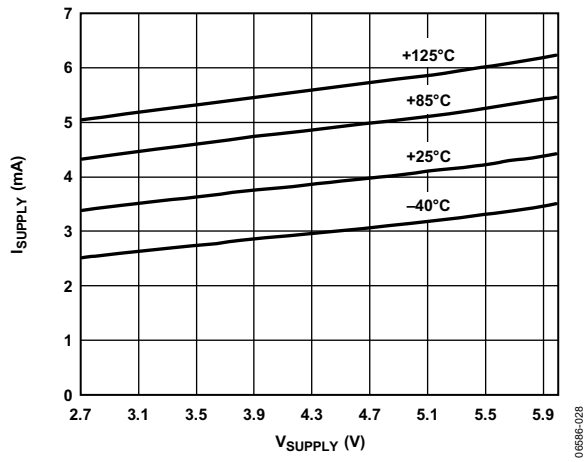

Figure 47. Supply Current vs. Supply Voltage

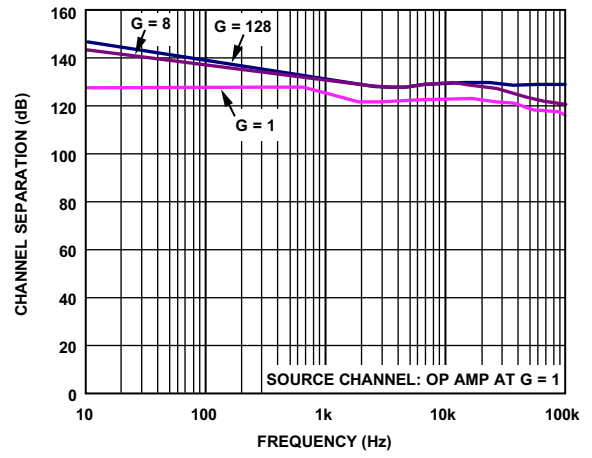

Figure 48. Channel Separation vs. Frequency

THEORY OF OPERATION

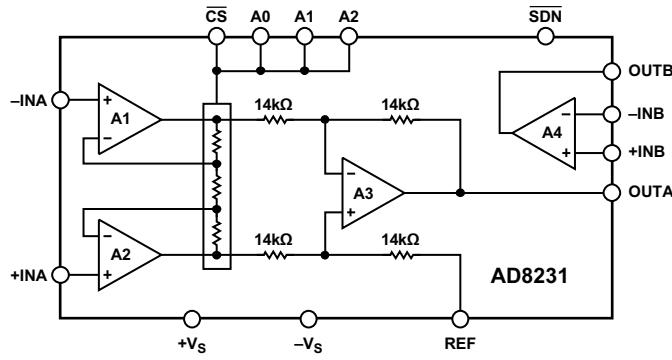

Figure 49. Simplified Schematic

AMPLIFIER ARCHITECTURE

The AD8231 is based on the classic 3-op amp topology. This topology has two stages: a preamplifier to provide amplification, followed by a difference amplifier to remove the common-mode voltage. Figure 49 shows a simplified schematic of the AD8231. The preamp stage is composed of Amplifier A1, Amplifier A2, and a digitally controlled resistor network. The second stage is a gain of 1 difference amplifier composed of Amplifier A3 and four 14 kΩ resistors. A1, A2, and A3 are all zero drift, rail-to-rail input, rail-to-rail-output amplifiers.

The AD8231 design makes it extremely robust over temperature. The AD8231 uses an internal thin film resistor to set the gain. Because all of the resistors are on the same die, gain temperature drift performance and CMRR drift performance are better than can be achieved with topologies using external resistors. The AD8231 also uses an auto-zero topology to null the offsets of all its internal amplifiers. Because this topology continually corrects for any offset errors, offset temperature drift is nearly nonexistent.

The AD8231 also includes a free operational amplifier. Like the other amplifiers in the AD8231, it is a zero drift, rail-to-rail input, rail-to-rail output architecture.

GAIN SELECTION

The gain of the AD8231 is set by voltages applied to the A0, A1, and A2 pins. To change the gain, the CS pin must be driven low. When the CS pin is driven high, the gain is latched, and voltages at the A0 to A2 pins have no effect. Because the CS pin is level sensitive rather than edge sensitive, it can also be tied permanently low. Table 7 shows the different gain settings.

The time required for a gain change is dominated by the settling time of the amplifier. The AD8231 takes about 200 ns to switch gains, after which the amplifier begins to settle. Refer to Figure 28 through Figure 32 to determine the settling time for different gains.

Table 7. Truth Table for AD8231 Gain Settings

| CS | A2 | A1 | A0 | Gain |
|------|------|------|------|-----------|
| Low | Low | Low | Low | 1 |
| Low | Low | Low | High | 2 |
| Low | Low | High | Low | 4 |
| Low | Low | High | High | 8 |
| Low | High | Low | Low | 16 |
| Low | High | Low | High | 32 |
| Low | High | High | Low | 64 |
| Low | High | High | High | 128 |
| High | X | X | X | No change |

REFERENCE TERMINAL

The output voltage of the AD8231 is developed with respect to the potential on the reference terminal, which is useful when the output signal needs to be offset to a midsupply level. For example, a voltage source can be tied to the REF pin to level-shift the output so that the AD8231 can drive a single-supply ADC. The REF pin is protected with ESD diodes and should not exceed either +Vs or -Vs by more than 0.3 V.

For best performance, source impedance to the REF terminal should be kept below 1 Ω. As shown in Figure 49, the reference terminal, REF, is at one end of a 14 kΩ resistor. Additional impedance at the REF terminal adds to this 14 kΩ resistor and results in amplification of the signal connected to the positive input, causing a CMRR error.

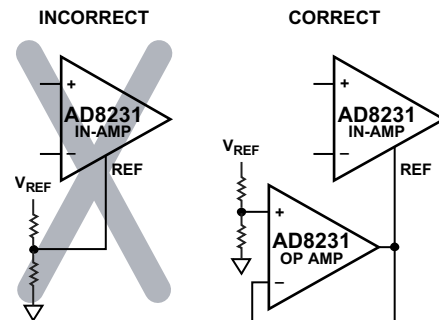

Figure 50. Driving the Reference (REF)

LAYOUT

The AD8231 is a high precision device. To ensure optimum performance at the PCB level, care must be taken in the design of the board layout. The AD8231 pinout is arranged in a logical manner to aid in this task.

Power Supplies

The AD8231 should be decoupled with a 0.1 μF bypass capacitor between the two supplies. This capacitor should be placed as close as possible to Pin 11 and Pin 12, either directly next to the pins or beneath the pins on the backside of the board. The auto-zero architecture of the AD8231 requires a low ac impedance between the supplies. Long trace lengths to the bypass capacitor increase this impedance, which results in a larger input offset voltage.

A stable dc voltage should be used to power the instrumentation amplifier. Noise on the supply pins can adversely affect performance.

Package Considerations

The AD8231 comes in a 4 mm \times 4 mm LFCSP. Beware of blindly copying the footprint from another 4 mm \times 4 mm LFCSP part; it cannot have the same thermal pad size and leads. Refer to the Outline Dimensions section to verify that the PCB symbol has the correct dimensions. Space between the leads and thermal pad should be kept as wide as possible for the best bias current performance.

Thermal Pad

The AD8231 4 mm \times 4 mm LFCSP comes with a thermal pad. This pad is connected internally to $-V_S$. The pad can either be left unconnected or connected to the negative supply rail. For high vibration applications, a landing is recommended.

Because the AD8231 dissipates little power, heat dissipation is rarely an issue. If improved heat dissipation is desired (for example, when ambient temperatures are near 125°C or when driving heavy loads), connect the thermal pad to the negative supply rail. For the best heat dissipation performance, the negative supply rail should be a plane in the board. See the Thermal Resistance section for thermal coefficients with and without the pad soldered.

INPUT BIAS CURRENT RETURN PATH

The input bias current of the AD8231 must have a return path to common. When the source, such as a thermocouple, cannot provide a return current path, one should be created, as shown in Figure 51.

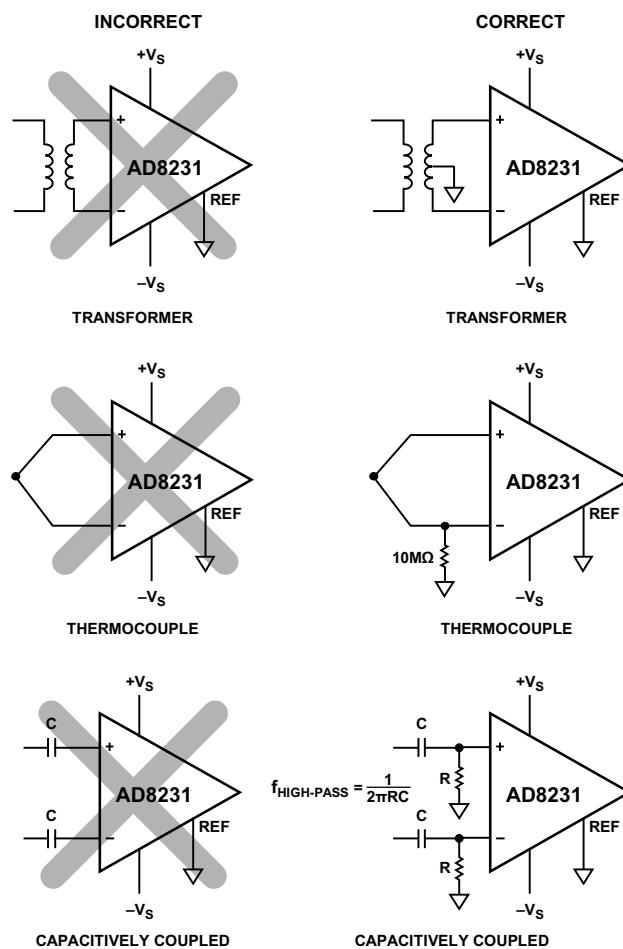

Figure 51. Creating an I_{BIAS} Path

INPUT PROTECTION

All terminals of the AD8231 are protected against ESD. In addition, the input structure allows for dc overload conditions a diode drop above the positive supply and a diode drop below the negative supply. Voltages beyond these limits cause the ESD diodes to conduct and current to flow. If overvoltage events are anticipated, an external resistor should be used in series with each of the inputs to limit the current to below 10 mA. Currents up to 100 mA can be sustained for a few seconds.

Note that if either input is brought below the negative supply to the point where the ESD diode turns on, the AD8231 output can phase-reverse.

AD8231

RF INTERFERENCE

RF rectification is often a problem when amplifiers are used in applications where there are strong RF signals. The disturbance can appear as a small dc offset voltage. High frequency signals can be filtered with a low-pass, RC network placed at the input of the instrumentation amplifier, as shown in Figure 52. The filter limits the input signal bandwidth according to the following relationship

$$FilterFreq_{diff} = \frac{1}{2 R(2C_D + \pi C_C)}$$

$$FilterFreq_{CM} = \frac{1}{2\pi R C_C}$$

where $C_D \geq 10C_C$.

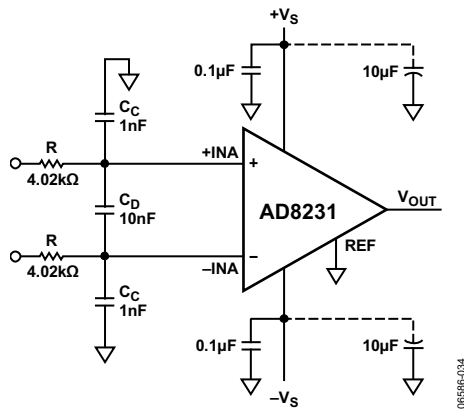

Figure 52. RFI Suppression

Figure 52 shows an example where the differential filter frequency is approximately 2 kHz, and the common-mode filter frequency is approximately 40 kHz.

Values of R and C_C should be chosen to minimize RFI. Mismatch between the $R \times C_C$ at the positive input and the $R \times C_C$ at the negative input degrades the CMRR of the AD8231. By using a value of C_D that is ten times larger than the value of C_C , the effect of the mismatch is reduced and performance is improved.

COMMON-MODE INPUT VOLTAGE RANGE

The 3-op amp architecture of the AD8231 applies gain and then removes the common-mode voltage. Therefore, internal nodes in the AD8231 experience a combination of both the gained signal and the common-mode signal. This combined signal can be limited by the voltage supplies even when the individual input and output signals are not. To determine whether the signal could be limited, refer to Figure 12 through Figure 14 or use the following formula

$$V_S - 0.04 V \leq V_{CM} \pm \frac{|V_{DIFF}| \times Gain}{2} \leq V_S + 0.04 V$$

If more common-mode range is required, the simplest solution is to apply less gain in the instrumentation amplifier. The extra op amp can be used to provide another gain stage after the in-amp. Because the AD8231 has good offset and noise performance at low gains, applying less gain in the instrumentation amplifier generally has a limited impact on the overall system performance.

REDUCING NOISE

Because the AD8231 has no 1/f noise, reducing the bandwidth corresponds directly to less noise. Table 8 shows the AD8231 performance at a gain of 1 at different bandwidths, assuming a 2-pole Butterworth filter roll off.

Table 8. AD8231 noise at various bandwidths

| Bandwidth (Hz) | Noise (μV rms) | SNR Single-Ended ¹ | | SNR Differential Output ² | |
|----------------|----------------------|-------------------------------|------|--------------------------------------|------|
| | | dB | Bits | dB | Bits |
| 1 | 0.07 | 148.3 | 24.3 | 154.3 | 25.3 |
| 3.2 | 0.12 | 143.2 | 23.5 | 149.2 | 24.5 |
| 10 | 0.21 | 138.3 | 22.7 | 144.3 | 23.7 |
| 32 | 0.37 | 133.2 | 21.8 | 139.2 | 22.8 |
| 100 | 0.66 | 128.3 | 21.0 | 137.63 | 22.0 |
| 320 | 1.17 | 123.2 | 20.2 | 129.2 | 21.2 |
| 1 k | 2.07 | 118.3 | 19.3 | 124.3 | 20.3 |
| 3.2 k | 3.71 | 113.2 | 18.5 | 119.2 | 19.5 |
| 10 k | 6.55 | 108.3 | 17.7 | 117.3 | 18.7 |
| 32 k | 11.73 | 103.2 | 16.9 | 109.2 | 17.9 |

¹ SNR for single-ended output configuration calculated with output signal of 4.8 V p-p, which corresponds to 1.697 V rms.

² SNR for differential output configuration calculated with output signal of 9.6 V p-p, which corresponds to 3.397 V rms.

The AD8231 has two clocks: an auto-zero clock at 3.4 kHz and a commutating clock at 54 kHz. While the auto-zero clock has negligible energy and can generally be ignored, the commutating clock has enough energy to significantly affect the noise of the part. Therefore, in applications where low noise is critical, limiting the bandwidth of the system below 54 kHz is recommended.

APPLICATIONS INFORMATION

DIFFERENTIAL OUTPUT

Figure 53 shows how to create a differential output in-amp using the AD8231 uncommitted op amp. Because this configuration makes use of the reference terminal of the in-amp, errors from the op amp and resistor mismatch result in common-mode errors, rather than differential errors. Because common-mode errors are typically rejected by the next device in the signal chain, this circuit configuration adds almost no extra error.

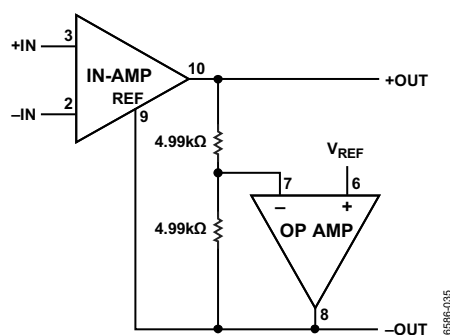

Figure 53. Differential Output Using Operational Amplifier

MULTIPLEXING

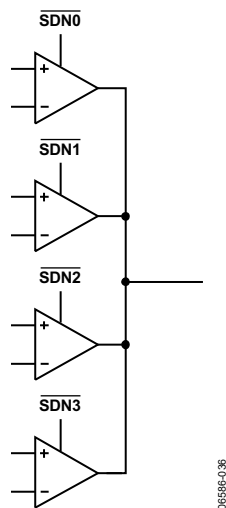

Figure 54. Four AD8231s in Multiplexing Configuration

The outputs of both the AD8231 in-amp and op amp are high impedance in the shutdown state. This feature allows several AD8231s to be multiplexed together without any external switches. Figure 54 shows an example of such a configuration. All the outputs are connected together and only one amplifier is turned on at a time. This feature is analogous to the high-Z mode of the digital tristate logic.

The resistors in the AD8231 instrumentation amplifier create a resistive path from the output to the reference pin of about 100 kΩ. If a higher output impedance in shutdown mode is desired, the reference pin can be driven with the op amp of the AD8231. In this configuration, the output impedance in shutdown is several GΩ, and many thousand AD8231s can theoretically be multiplexed in such a way.

The AD8231 can enter and leave shutdown mode very quickly. However, when the amplifier wakes up and reconnects its input circuitry, the voltage at its internal input nodes changes dramatically. It takes time for the output of the amplifier to settle. Refer to Figure 28 through Figure 32 to determine the settling time for different gains. This settling time limits how quickly the AD8231 can be multiplexed with the $\overline{\text{SDN}}$ pin.

USING THE AD8231 WITH BIPOLAR SUPPLIES

The AD8231 can be used with bipolar supplies as long as the maximum voltage drop between the supply rails is kept below 6 V and all input voltages are kept within the supply rails.

With bipolar supplies, the acceptable levels for the digital inputs A0, A1, A2, CS, and $\overline{\text{SDN}}$ shift. Table 9 shows acceptable values for low and high signals for both single and dual supplies.

Table 9. Digital Pin Thresholds

| Supply Voltage (V) | Low | | High | |
|--------------------|---------|---------|---------|---------|
| | Min (V) | Max (V) | Min (V) | Max (V) |
| 0 to 5 | 0 | +1 | 4 | 5 |
| 0 to 3 | 0 | +0.8 | 2.2 | 3 |
| -2.5 to +2.5 | -2.5 | -1.5 | 1.5 | 2.5 |
| -1.5 to +1.5 | -1.5 | -0.7 | 0.7 | 1.5 |

AD8231

When operating the AD8231 on dual supplies, a level-shift is typically needed from standard single-supply control logic. One easy way to accomplish the level-shift is through a single-pole, double-throw switch, such as the ADG633. Figure 55 shows an application schematic for ± 2.5 V operation.

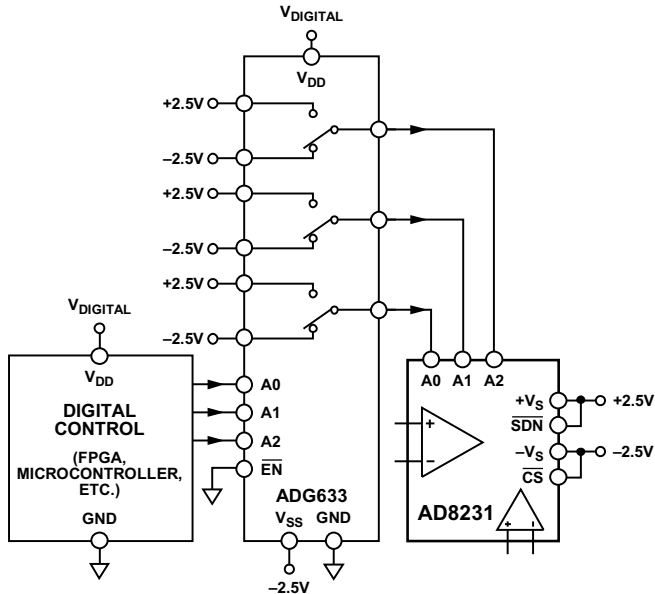

$V_{DIGITAL}$ IS THE DIGITAL SUPPLY VOLTAGE. IT CAN BE ANY VOLTAGE BETWEEN 2.5V AND 9.5V.

Figure 55. Converting Single-Supply Control Signals to Dual Supply.

SALLEN KEY FILTER

The extra op amp in the AD8231 can be used to create a 2-pole Sallen Key filter. Such a filter can remove excess noise or perform antialiasing before an analog-to-digital converter.

Figure 56 shows how to create a 2-pole low-pass Butterworth filter. Components R1, R2, C1, and C2 set the frequency of the filter. The ratio of R3 and R4 sets the peaking of the filter. If R4 equals 10 k Ω , R3 should equal 5.9 k Ω for an optimum 2-pole response.

Depending on the circuitry before and after the AD8231, a 3-pole filter can be possible. If the previous stage has a small output impedance, an additional pole can be added before the in amp (R6, R7, and C4). If the following stage has a high input impedance, an additional pole can be added after the op amp (R5 and C3). Peaking from the Sallen Key stage should be higher to compensate for the extra attenuation of the third pole; both R3 and R4 should be 10 k Ω for optimum response.

Note that in addition to setting the peaking of the filter, the ratio R3/R4 also sets the dc gain: $G = 1 + R3/R4$. If lower dc gain is required, replace R1 with a voltage divider, where the output resistance of the divider is equal to the required value of R1.

Figure 56 shows a bias point connected to R4 and the in-amp reference. The filter stage amplifies the signal around this bias point. The bias point is typically midsupply and should be low impedance.

Table 10. Recommended Component Values for Butterworth Low-Pass Filter in Figure 56

| 3 dB Freq | Sallen Key | | Optional Poles | | | |
|-----------|----------------------|-------------|----------------------|---------|------------------|---------|
| | R1, R2 (k Ω) | C1, C2 (nF) | Before In-Amp | | After Op Amp | |
| | | | R6, R7 (k Ω) | C4 (nF) | R5 (k Ω) | C3 (nF) |
| 32 Hz | 499 | 10 | 499 | 4.7 | 49.9 | 100 |
| 100 Hz | 158 | 10 | 158 | 4.7 | 16 | 100 |
| 320 Hz | 49.9 | 10 | 49.9 | 4.7 | 4.99 | 100 |
| 1 kHz | 15.8 | 1 | 15.8 | 0.47 | 1.6 | 100 |
| 3.2 kHz | 4.99 | 1 | 4.99 | 0.47 | 0.499 | 100 |
| 10 kHz | 1.58 | 1 | 1.58 | 0.47 | 0.16 | 100 |
| 32 kHz | 0.499 | 1 | 0.499 | 0.47 | 0.049 | 100 |

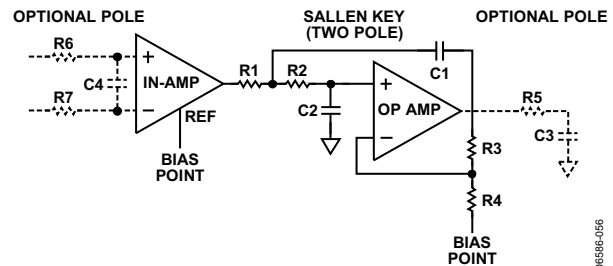
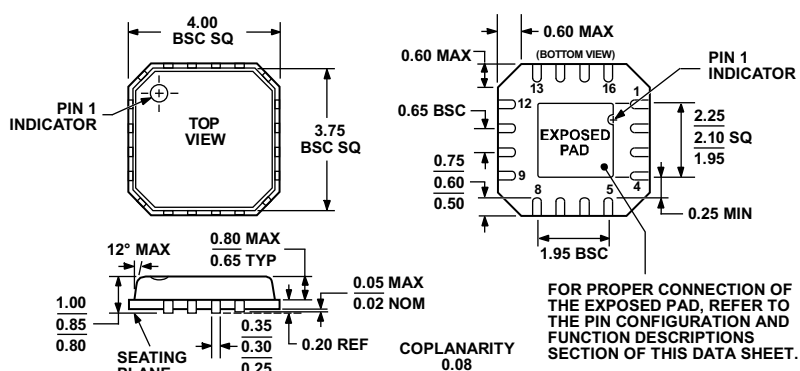

Figure 56. Butterworth Low-Pass Filter (Dotted Sections Indicate Optional Poles)

OUTLINE DIMENSIONS



COMPLIANT TO JEDEC STANDARDS MO-220-VGGC

Figure 57. 16-Lead Lead Frame Chip Scale Package [LFCSP_VQ]
4 mm × 4 mm Body, Very Thin Quad
(CP-16-4)
Dimensions shown in millimeters

ORDERING GUIDE

| Model ^{1, 2} | Temperature Range | Package Description | Package Option |
|-----------------------|-------------------|-------------------------------------|----------------|
| AD8231ACPZ-R7 | −40°C to +125°C | 16-Lead LFCSP_VQ, 7" Tape and Reel | CP-16-4 |
| AD8231ACPZ-RL | −40°C to +125°C | 16-Lead LFCSP_VQ, 13" Tape and Reel | CP-16-4 |
| AD8231ACPZ-WP | −40°C to +125°C | 16-Lead LFCSP_VQ, Waffle Pack | CP-16-4 |
| AD8231WACPZ-RL | −40°C to +125°C | 16-Lead LFCSP_VQ, 13" Tape and Reel | CP-16-4 |
| AD8231-EVALZ | | Evaluation Board | |

¹ Z = RoHS Compliant Part.

² W = Qualified for Automotive Applications.

AUTOMOTIVE PRODUCTS

The AD8231W models are available with controlled manufacturing to support the quality and reliability requirements of automotive applications. Note that these automotive models may have specifications that differ from the commercial models; therefore, designers should review the Specifications section of this data sheet carefully. Only the automotive grade products shown are available for use in automotive applications. Contact your local Analog Devices, Inc. account representative for specific product ordering information and to obtain the specific Automotive Reliability reports for these models.

AD8231

NOTES