

PWM Control 2A Step-Down Converter

❖ GENERAL DESCRIPTION

AX3106 consists of step-down switching regulator with PWM control. These device include a reference voltage source, oscillation circuit, error amplifier, internal PMOS and etc.

AX3106 provides low-ripple power, high efficiency, and excellent transient characteristics. The PWM control circuit is able to every the duty ratio linearly form 0 up to 100%. This converter also contains an error amplifier circuit as well as a soft-start circuit that prevents overshoot at startup. An enable function, an over current protect function and short circuit protect function are built inside, and when OCP or SCP happens, the operation frequency will be reduced. Also, an internal compensation block is built in to minimum external component count.

With the addition of an internal P-channel Power MOS, a coil, capacitors, and a diode connected externally, these ICs can function as step-down switching regulators. They serve as ideal power supply units for portable devices when coupled with the SOP-8L package, providing such outstanding features as low current consumption. Since this converter can accommodate an input voltage up to 23V, it is also suitable for the operation via an AC adapter.

❖ FEATURES

- Input voltage : 3.6V to 23V
- Output voltage : 0.8V to V_{CC}
- Duty ratio : 0% to 100% PWM control
- Oscillation frequency : 330KHz typ.
- Soft-start (SS), Current Limit (CL), Enable function.
- Thermal Shutdown function.
- Short Circuit Protect (SCP).
- Built-in internal SW P-channel MOS.
- Low ESR output capacitor (Multi-layer chip capacitor (MLCC)) application.
- SOP-8L Pb-Free package.

❖ ABSOLUTE MAXIMUM RATINGS (at $T_A=25^\circ\text{C}$)

Characteristics	Symbol	Rating	Unit
VCC Pin Voltage	V_{CC}	$V_{SS} - 0.3$ to $V_{SS} + 25$	V
Feedback Pin Voltage	V_{FB}	$V_{SS} - 0.3$ to V_{CC}	V
ON/OFF Pin Voltage	V_{EN}	$V_{SS} - 0.3$ to $V_{CC} + 0.3$	V
Switch Pin Voltage	V_{SW}	$V_{SS} - 0.3$ to $V_{CC} + 0.3$	V
Power Dissipation	PD	Internally limited	mW
Storage Temperature Range	T_{ST}	-40 to +150	$^\circ\text{C}$
Operating Junction Temperature Range	T_J	-20 to +125	$^\circ\text{C}$
Operating Supply Voltage	V_{OP}	+3.6 to +20	V
Thermal Resistance from Junction to case	θ_{JC}	25	$^\circ\text{C/W}$
Thermal Resistance from Junction to ambient	θ_{JA}	70	$^\circ\text{C/W}$

Note: θ_{JA} is measured with the PCB copper area(need connect to SW pins) of approximately 1 in²(Multi-layer).

❖ ELECTRICAL CHARACTERISTICS ($V_{IN} = 12\text{V}$, $T_A=25^\circ\text{C}$, unless otherwise specified)

Characteristics	Symbol	Conditions	Min	Typ	Max	Units	
Feedback Voltage	V_{FB}	$I_{OUT}=0.2\text{A}$	0.784	0.8	0.816	V	
Quiescent Current	I_{CCQ}	$V_{FB}=1.2\text{V}$ force driver off		3	5	mA	
Feedback Bias Current	I_{FB}	$I_{OUT}=0.2\text{A}$	-	0.1	0.5	μA	
Shutdown Supply Current	I_{SD}	$V_{EN}=0\text{V}$	-	2	10	μA	
Current Limit	I_{CL}		3.0	-	-	A	
Line Regulation	$\Delta V_{OUT}/V_{OUT}$	$V_{CC}=4\text{V}\sim 23\text{V}$, $I_{OUT}=0.2\text{A}$	-	0.6	1.2	%	
Load Regulation	$\Delta V_{OUT}/V_{OUT}$	$I_{OUT} = 0.2$ to 2A	-	0.15	0.3	%	
Oscillation Frequency	F_{OSC}	SW pin	260	330	400	KHz	
EN Pin Logic input threshold voltage	V_{SH}	High (regulator ON)	2.0	-	-	V	
	V_{SL}	Low(regulator OFF)	-	-	0.8		
EN Pin Input Current	I_{SH}	$V_{EN}=2.5\text{V}$ (ON)	-	20	-	μA	
	I_{SL}	$V_{EN}=0.3\text{V}$ (OFF)	-	-10	-	μA	
Soft-Start Time	T_{SS}		-	20	-	ms	
Internal MOSFET $R_{DS(ON)}$	$R_{DS(ON)}$	$V_{CC}=12\text{V}$, $V_{FB}=0\text{V}$	-	70	-	m Ω	
Efficiency	EFFI	$V_{OUT}=5\text{V}$	$I_{OUT}=1\text{A}$	-	92	-	%
			$I_{OUT}=2\text{A}$	-	92	-	
Thermal shutdown Temp	T_{SD}			125		$^\circ\text{C}$	

❖ APPLICATION CIRCUIT

1. MLCC

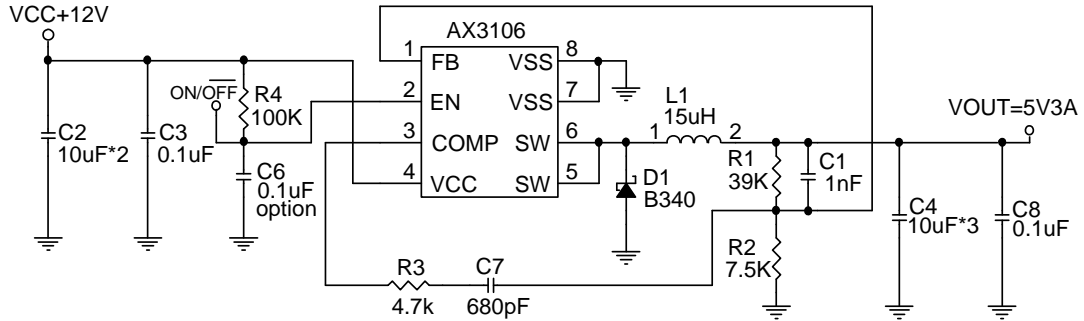

$$V_{OUT} = V_{FB} \times \left(1 + \frac{R1}{R2}\right)$$

$V_{FB} = 0.8V$; $R1$ suggest 10K ~ 50K

Compensation Capacitor Selection(MLCC)					
V_{IN}	V_{OUT}	L1	R3	C7	C1
12V	5.0/3.3/2.5V	15uH	4.7K	680pF	1nF
5V	3.3/2.5V	15uH	6.8K	470pF	1nF

2. EL CAP

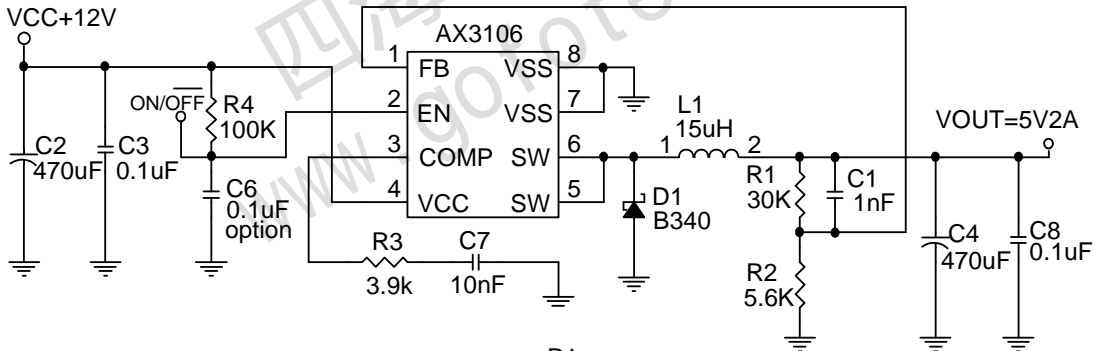

$$V_{OUT} = V_{FB} \times \left(1 + \frac{R1}{R2}\right)$$

$V_{FB} = 0.8V$; $R2$ suggest 0.8K ~ 6.0K

Compensation Capacitor Selection(EL CAP)					
V_{IN}	V_{OUT}	L1	R3	C7	C1
5-20V	5.0/3.3/2.5/1.8V	15uH	3.9K	10nF	1nF

❖ FUNCTION DESCRIPTIONS

PWM Control

The AX3106 consists of DC/DC converters that employ a pulse-width modulation (PWM) system. In converters of the AX3106, the pulse width varies in a range from 0 to 100%, according to the load current. The ripple voltage produced by the switching can easily be removed through a filter because the switching frequency remains constant. Therefore, these converters provide a low-ripple power over broad ranges of input voltage and load current.

Setting the Output Voltage

Application circuit item shows the basic application circuit with adjustable output version. The external resistor sets the output voltage according to the following equation:

$$V_{OUT} = 0.8V \times \left(1 + \frac{R1}{R2} \right)$$

Table 1 Resistor select for output voltage setting

V _{OUT}	C _{OUT}	R2	R1
5V	EL	1.3K	6.8K
	MLCC	7.5K	39K
3.3V	EL	1.5K	4.7K
	MLCC	15K	47K
2.5V	EL	2.2K	4.7K
	MLCC	22K	47K
1.8V	EL	2K	2.5K
1.5V	EL	2.2K	2.0K
1.2V	EL	3K	1.5K

Inductor Selection

For most designs, the operates with inductors of 15μH to 33μH. The inductor value can be derived from the following equation:

$$L = \frac{V_{OUT} \times (V_{IN} - V_{OUT})}{V_{IN} \times \Delta I_L \times f_{OSC}}$$

Where is inductor Ripple Current. Large value inductors lower ripple current and small value inductors result in high ripple currents. Choose inductor ripple current approximately 15% of the maximum load current 2A, $\Delta I_L=0.3A$. The DC current rating of the inductor should be at least equal to the maximum load current plus half the ripple current to prevent core saturation (2A+0.15A).

Input Capacitor Selection

(EL CAP)

This capacitor should be located close to the IC using short leads and the voltage rating should be approximately 1.5 times the maximum input voltage. The RMS current rating requirement for the input capacitor of a buck regulator is approximately 1/2 the DC load current. A low ESR input capacitor sized for maximum RMS current must be used. A 220μF low ESR capacitor for most applications is sufficient.

(MLCC)

A 22μF MLCC or greater capacitor for most applications is sufficient.

Note: MLCC do not support when V_{OUT} is smaller than 2.5V.

Output Capacitor Selection

(EL CAP)

The output capacitor is required to filter the output and provide regulator loop stability. The important capacitor parameters are; the 100KHz Equivalent Series Resistance (ESR), the RMS ripples current rating, voltage rating, and capacitance value. For the output capacitor, the ESR value is the most important parameter. The ESR can be calculated from the following formula.

$$V_{RIPPLE} = \Delta I_L \times ESR = 0.33A \times 130m\Omega = 43mV$$

An aluminum electrolytic capacitor's ESR value is related to the capacitance and its voltage rating. In most case, higher voltage electrolytic capacitors have lower ESR values. Most of the time, capacitors with much higher voltage ratings may be needed to provide the low ESR values required for low output ripple voltage. It is recommended to replace this low ESR capacitor by using a 330 μ F low ESR values < 130m Ω .

(MLCC CAP)

A 22 μ F MLCC capacitor for most applications is sufficient.

RDS (ON) Current Limiting

The current limit threshold is setting by the internal circuit.

V _{IN}	4V~4.6V	4.6V~8V	8V~20V
I _{CL} (MIN)	2.5A	2.8A	3.0A
I _{OUT} (MAX)	1.8A	2A	2A

PCB Layout Guide

If you need low T_c and T_j or large PD(Power Dissipation), The dual SW pins(5 and 6) and V_{SS} pins(7 and 8)on the SOP-8L package are internally connected to die pad, The PCB layout should allow for maximum possible copper area at the SW pins.

1. Connect C3 to V_{CC} and V_{SS} pin as closely as possible to get good power filter effect.
2. Connect ground side of the C2 and D1 as closely as possible.

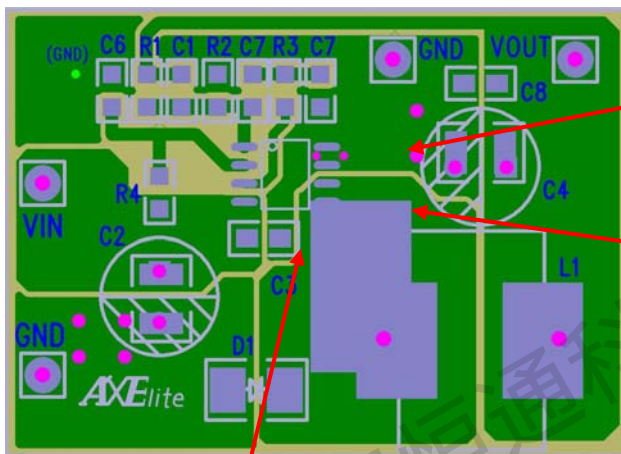

Use through hole to conduct the heat into the backside of PCB layer.

The heat sink copper of PCB area should be solder-painted without masked.

Bypass C3 need closely from IC's V_{CC} to V_{SS} pins.

❖ TYPICAL CHARACTERISTICS

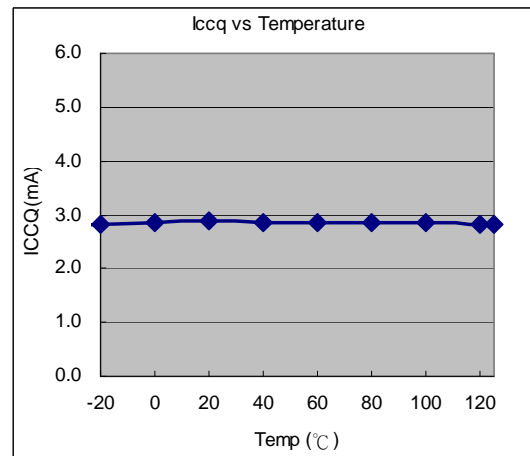
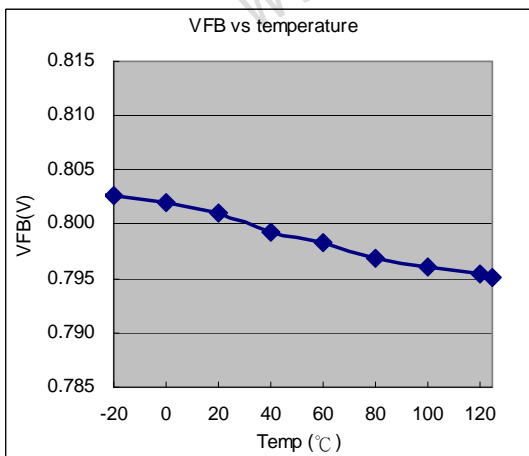
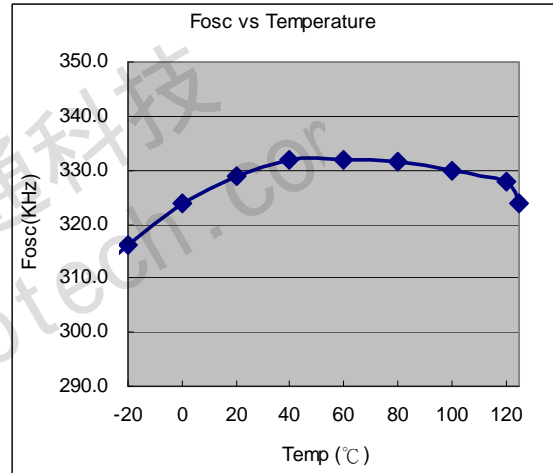
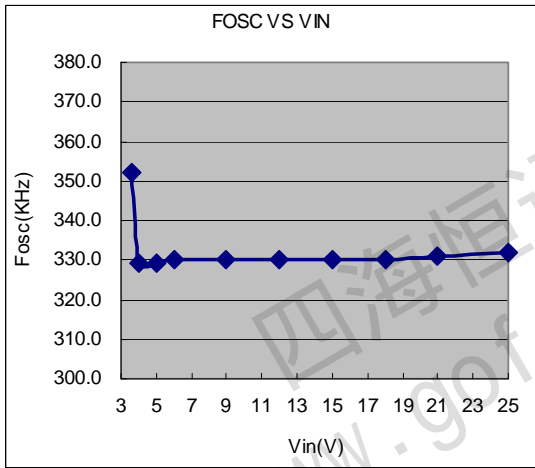
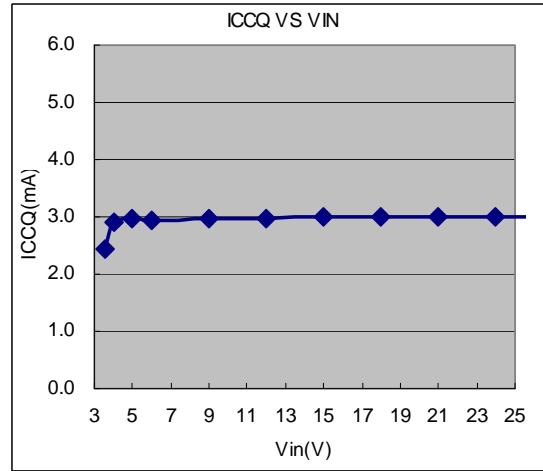
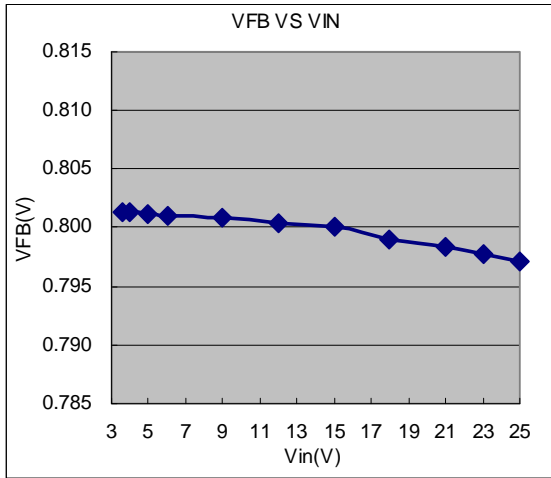

❖ TYPICAL CHARACTERISTICS (MLCC)

Output Ripple
($V_{IN}=12V, V_{OUT}=5V, I_{OUT}=2A$)

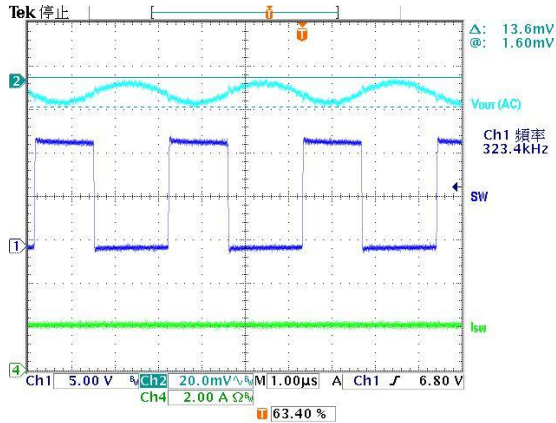

Power on test wave
($V_{IN}=12V, V_{OUT}=5V, I_{OUT}=2A$)

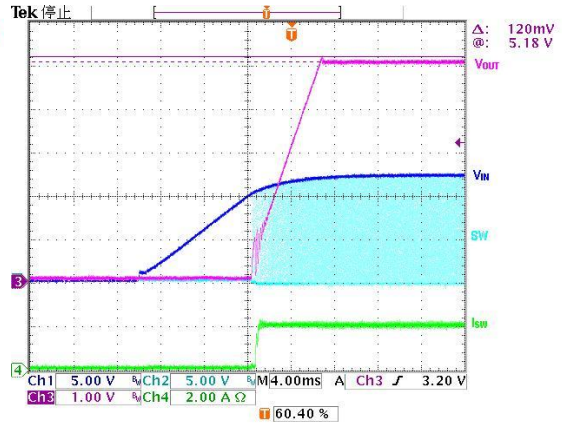

Load Transient Response
($V_{IN}=12V, V_{OUT}=5V, I_{OUT}=0.1\sim 2A$)

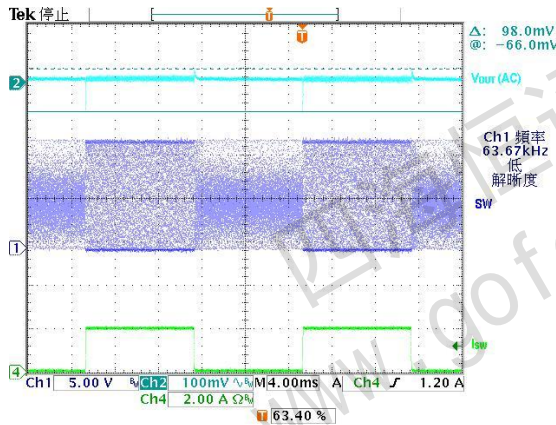

EN PIN on test wave
($V_{IN}=12V, V_{OUT}=5V, I_{OUT}=0.2A$)

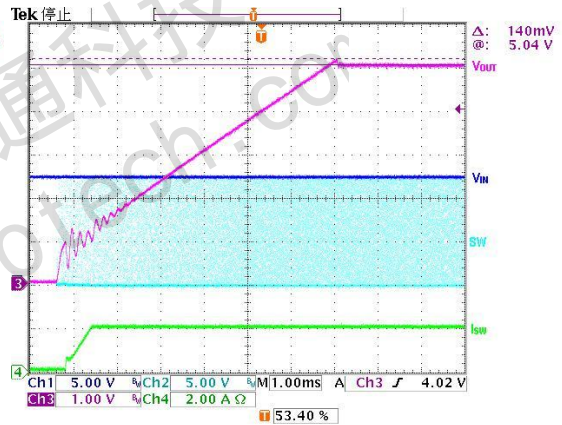

Efficiency
($V_{IN}=12V, V_{OUT}=5V$)

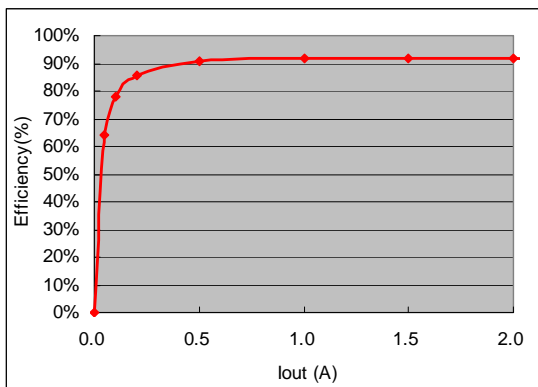

Efficiency
($V_{IN}=12V, V_{OUT}=3.3V$)

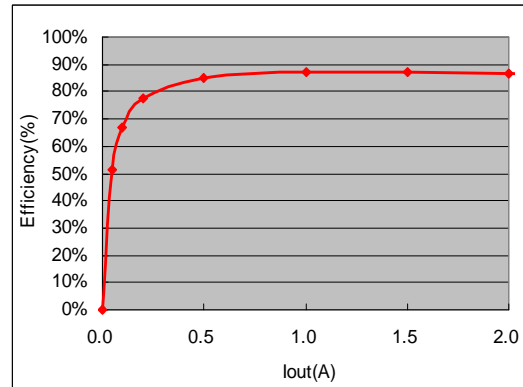

❖ TYPICAL CHARACTERISTICS (EL CAP)

Output Ripple
($V_{IN}=12V, V_{OUT}=5V, I_{OUT}=2A$)

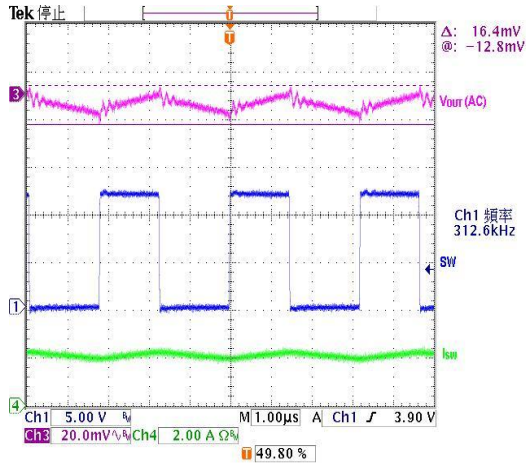

Power on test wave
($V_{IN}=12V, V_{OUT}=5V, I_{OUT}=2A$)

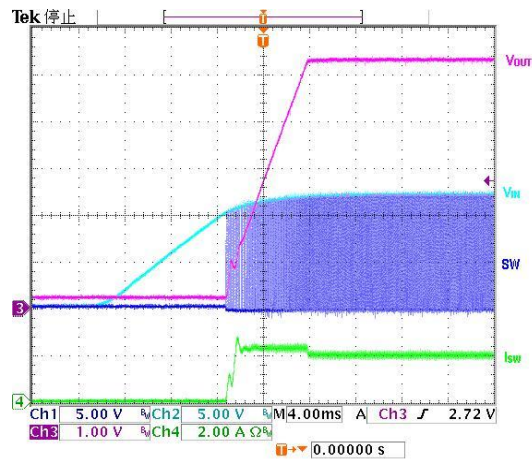

Load Transient Response
($V_{IN}=12V, V_{OUT}=5V, I_{OUT}=0.1\sim 2A$)

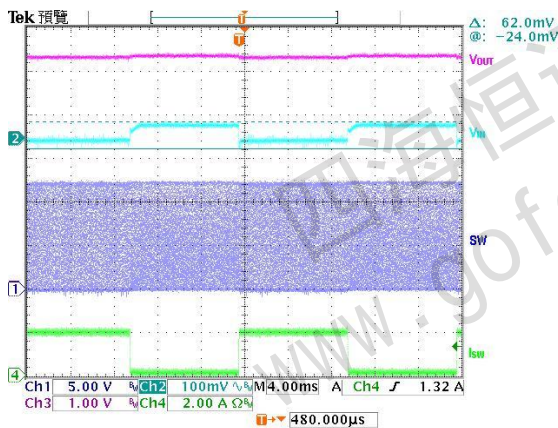

EN PIN on test wave
($V_{IN}=12V, V_{OUT}=5V, I_{OUT}=2A$)

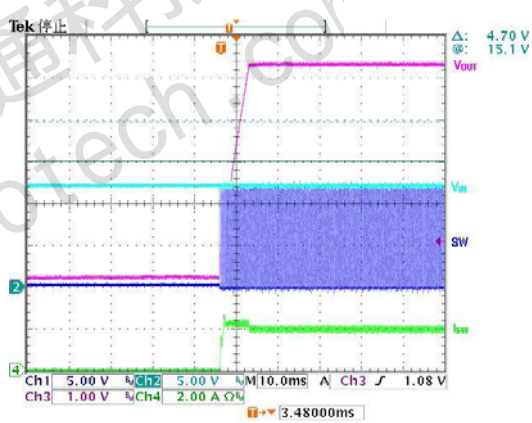

Efficiency
($V_{IN}=12V, V_{OUT}=5V/3.3V$)

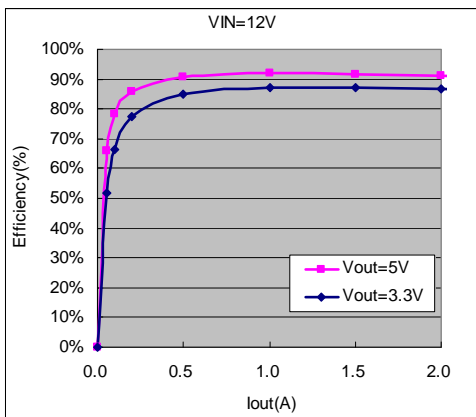

Efficiency
($V_{IN}=5V, V_{OUT}=3.3V/2.5V$)

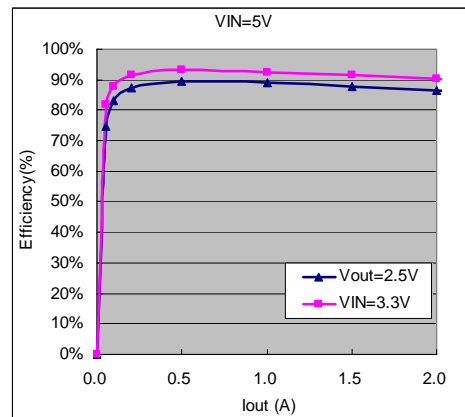

❖ PACKAGE OUTLINES

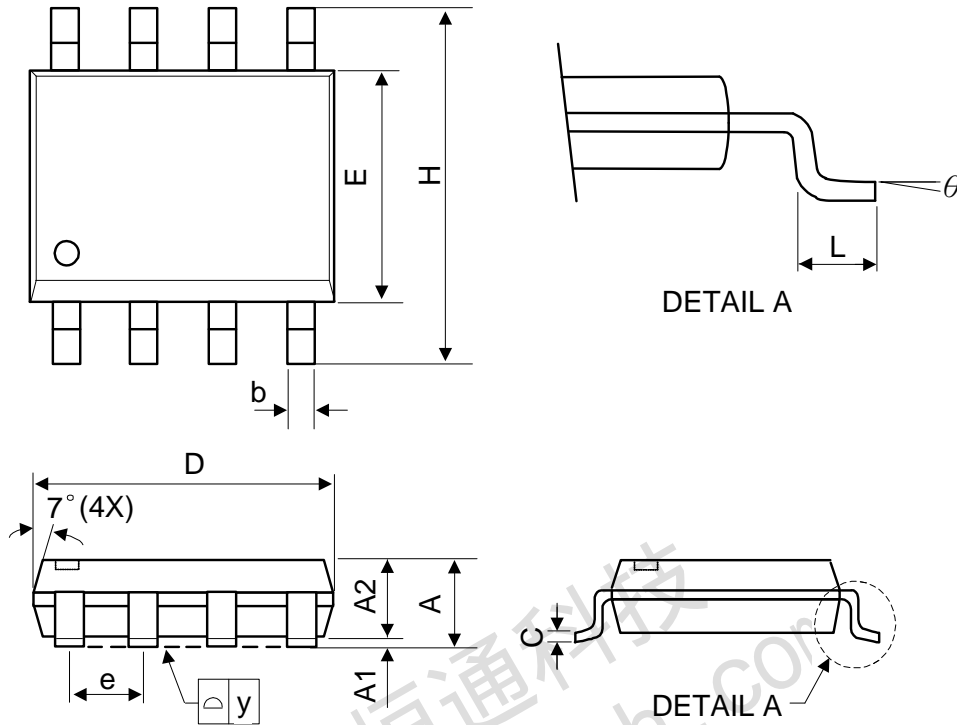

Symbol	Dimensions in Millimeters			Dimensions in Inches		
	Min.	Nom.	Max.	Min.	Nom.	Max.
A	-	-	1.75	-	-	0.069
A1	0.1	-	0.25	0.04	-	0.1
A2	1.25	-	-	0.049	-	-
C	0.1	0.2	0.25	0.0075	0.008	0.01
D	4.7	4.9	5.1	0.185	0.193	0.2
E	3.7	3.9	4.1	0.146	0.154	0.161
H	5.8	6	6.2	0.228	0.236	0.244
L	0.4	-	1.27	0.015	-	0.05
b	0.31	0.41	0.51	0.012	0.016	0.02
e	1.27 BSC			0.050 BSC		
y	-	-	0.1	-	-	0.004
θ	0°	-	8°	0°	-	8°

Mold flash shall not exceed 0.25mm per side

JEDEC outline: MS-012 AA