

입력전압(VCC)이 5V 이상일때  
R2 저항을 제거해주시고 R3에  
0ohm을 연결해주시기바랍니다.

입력전압(VCC)이 3.3V 일때  
R2 저항에 0ohm 연결해주시고  
R3저항을 제거해 주시기  
바랍니다.

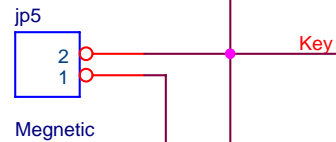
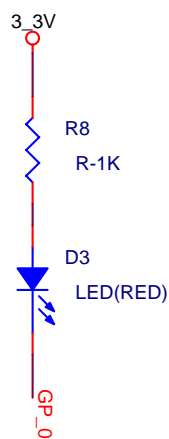
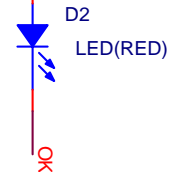
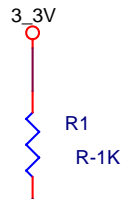
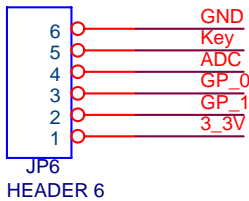
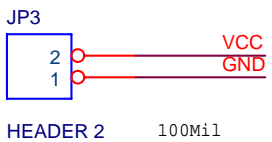
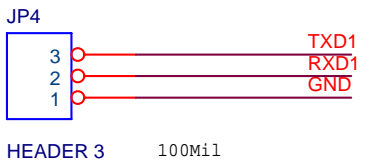
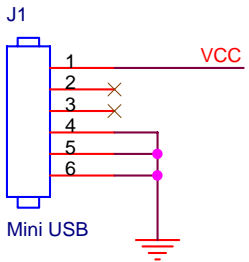

FZ800ED\_INT\_MAGNETIC의  
JP4를 통해서 출력되는  
신호를 EIA Level로  
사용하실려면 R4,R5의  
연결을 끊어주시고  
U2(MAX3238)와  
C5,C6,C7,C8,C9에 각각  
0.1uF를  
연결하시기바랍니다.

FZ800ED\_INT\_MAGNETIC의  
JP4를 통해서 출력되는  
신호를 TTL Level로  
사용하실려면 R4,R5에  
0ohm을 연결해주시고 U2,  
C5,C6,C7,C8,C9를  
제거해주시기바랍니다.

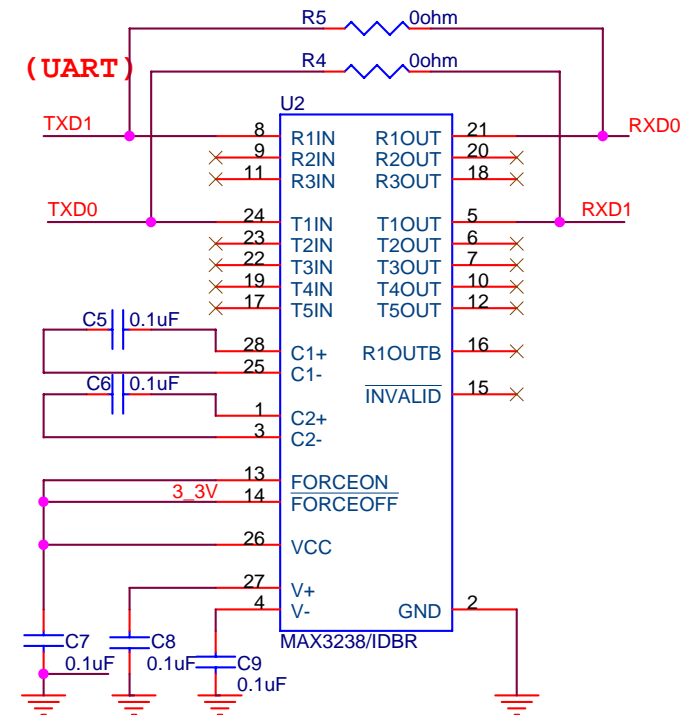

Title		
FZ800ED_INT_MAGNETIC		
Size	Document Number	Rev
A	<Doc>	<RevCode>
Date:	Friday, November 14, 2008	Sheet 1 of 1