



Inductors for Standard Circuits

Multilayer Ferrite

MLF series

MLF1005	1005 [0402 inch]*
MLF1608	1608 [0603 inch]
MLF2012	2012 [0805 inch]

* Dimensions Code JIS[EIA]

REMINDERS FOR USING THESE PRODUCTS

Before using these products, be sure to request the delivery specifications.

SAFETY REMINDERS

Please pay sufficient attention to the warnings for safe designing when using these products.

REMINDERS

- The storage period is less than 12 months. Be sure to follow the storage conditions (Temperature: 5 to 40°C, Humidity: 10 to 75% RH or less).
If the storage period elapses, the soldering of the terminal electrodes may deteriorate.
- Do not use or store in locations where there are conditions such as gas corrosion (salt, acid, alkali, etc.).
- Before soldering, be sure to preheat components.
The preheating temperature should be set so that the temperature difference between the solder temperature and chip temperature does not exceed 150°C.
- Soldering corrections after mounting should be within the range of the conditions determined in the specifications.
If overheated, a short circuit, performance deterioration, or lifespan shortening may occur.
- When embedding a printed circuit board where a chip is mounted to a set, be sure that residual stress is not given to the chip due to the overall distortion of the printed circuit board and partial distortion such as at screw tightening portions.
- Self heating (temperature increase) occurs when the power is turned ON, so the tolerance should be sufficient for the set thermal design.
- Carefully lay out the coil for the circuit board design of the non-magnetic shield type.
A malfunction may occur due to magnetic interference.
- Use a wrist band to discharge static electricity in your body through the grounding wire.
- Do not expose the products to magnets or magnetic fields.
- Do not use for a purpose outside of the contents regulated in the delivery specifications.
- The products listed on this catalog are intended for use in general electronic equipment (AV equipment, telecommunications equipment, home appliances, amusement equipment, computer equipment, personal equipment, office equipment, measurement equipment, industrial robots) under a normal operation and use condition.
The products are not designed or warranted to meet the requirements of the applications listed below, whose performance and/or quality require a more stringent level of safety or reliability, or whose failure, malfunction or trouble could cause serious damage to society, person or property.
If you intend to use the products in the applications listed below or if you have special requirements exceeding the range or conditions set forth in the each catalog, please contact us.

- (1) Aerospace/Aviation equipment
- (2) Transportation equipment (cars, electric trains, ships, etc.)
- (3) Medical equipment
- (4) Power-generation control equipment
- (5) Atomic energy-related equipment
- (6) Seabed equipment
- (7) Transportation control equipment

- (8) Public information-processing equipment
- (9) Military equipment
- (10) Electric heating apparatus, burning equipment
- (11) Disaster prevention/crime prevention equipment
- (12) Safety equipment
- (13) Other applications that are not considered general-purpose applications

When designing your equipment even for general-purpose applications, you are kindly requested to take into consideration securing protection circuit/device or providing backup circuits in your equipment.

Inductors for Standard Circuits

Multilayer Ferrite

Product compatible with RoHS directive
Halogen-free
Compatible with lead-free solders
AEC-Q200

Overview of the MLF Series

FEATURES

- The lineup includes a wide inductance range.
- Highly reliable monolithic structure with multilayer integration.

APPLICATION

Smart phones, tablet terminals, tuners, LCD-TVs, PDP-TVs, audio equipment, computers, signal processing for modules, automotive equipment (MLF1608, MLF2012) etc.

PART NUMBER CONSTRUCTION

MLF	1005	L	R10	K	T	□□□		
Series name	LxWxH Dimensions (mm)		characteristics	Inductance (μH)		Inductance tolerance	Packaging style	Internal code
1005	1.0x0.5x0.5		A	10N	0.010	K ±10%	T Taping	□□□
1608	1.6x0.8x0.8		C		(10nH)			
2012	2.0x1.25x0.85		D	R10	0.1			
	2.0x1.25x1.25		E	1R0	1			
			G	100	10			
			K					
			L					
			V					

OPERATING TEMPERATURE RANGE, PACKAGE QUANTITY, PRODUCT WEIGHT

Type	Temperature range		Package quantity (pieces/reel)	Individual weight (mg)	
	Operating temperature (°C)	Storage temperature* (°C)			
	MLF1005V.1005G	-55 to +125			-55 to +125
MLF1005L	-40 to +85	-40 to +85	10,000	1.2	
MLF1608	-40 to +85	-40 to +85	4,000	4	
MLF2012	t=0.85	-40 to +85	-40 to +85	4,000	10
	t=1.25			2,000	14

* The Storage temperature range is for after the circuit board is mounted.

- RoHS Directive Compliant Product: See the following for more details related to RoHS Directive compliant products. <http://www.tdk.co.jp/rohs/>
- Halogen-free: Indicates that Cl content is less than 900ppm, Br content is less than 900ppm, and that the total Cl and Br content is less than 1500ppm.

• All specifications are subject to change without notice.

Overview of the MLF Series

RECOMMENDED REFLOW PROFILE

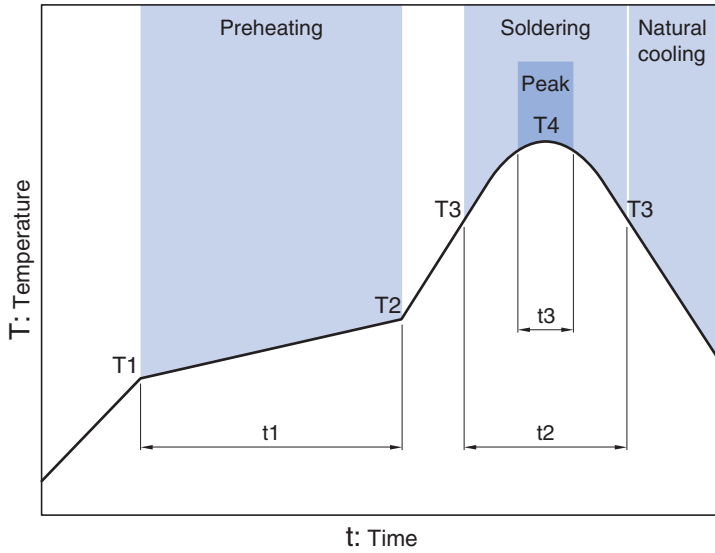

Preheating			Soldering		Peak	
Temp.	Temp.	Time	Temp.	Time	Temp.	Time
T1	T2	t1	T3	t2	T4	t3
150°C	180°C	60 to 120s	230°C	30 to 60s	250 to 260°C	10s max.

• All specifications are subject to change without notice.

MLF series

MLF1005 Type



■ SHAPE & DIMENSIONS

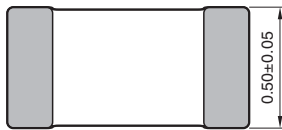
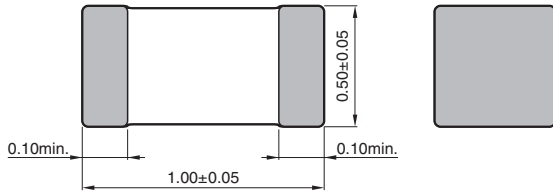

Dimensions in mm

■ RECOMMENDED LAND PATTERN

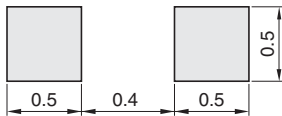

Dimensions in mm

• All specifications are subject to change without notice.

MLF series **MLF1005 Type**

■ ELECTRICAL CHARACTERISTICS

□ CHARACTERISTICS SPECIFICATION TABLE

L (μH)	Tolerance	L, Q measuring conditions		Q min.	Self-resonant frequency (MHz) min.	DC resistance (Ω) max.	Rated current (mA) max.	Part No.*
		Frequency (MHz)	Current (mA)					
0.10	$\pm 10\%$	25	1.0	10	450	0.51	180	MLF1005VR10KT□□□
0.12	$\pm 10\%$	25	1.0	10	400	0.59	180	MLF1005VR12KT□□□
0.15	$\pm 10\%$	25	1.0	15	350	0.63	180	MLF1005VR15KT□□□
0.18	$\pm 10\%$	25	1.0	15	320	0.72	160	MLF1005VR18KT□□□
0.22	$\pm 10\%$	25	1.0	15	290	0.79	160	MLF1005VR22KT□□□
0.27	$\pm 10\%$	25	1.0	15	260	0.91	150	MLF1005VR27KT□□□
0.33	$\pm 10\%$	25	1.0	15	230	1.05	140	MLF1005VR33KT□□□
0.39	$\pm 10\%$	25	1.0	15	210	1.35	130	MLF1005VR39KT□□□
0.47	$\pm 10\%$	25	1.0	15	190	1.50	120	MLF1005VR47KT□□□
0.56	$\pm 10\%$	25	1.0	15	170	1.95	120	MLF1005VR56KT□□□
0.39	$\pm 10\%$	10	1.0	30	210	0.41	50	MLF1005GR39KT□□□
0.47	$\pm 10\%$	10	1.0	30	190	0.42	50	MLF1005GR47KT□□□
0.56	$\pm 10\%$	10	1.0	30	170	0.47	45	MLF1005GR56KT□□□
0.68	$\pm 10\%$	10	1.0	30	150	0.55	45	MLF1005GR68KT□□□
0.82	$\pm 10\%$	10	1.0	30	130	0.59	40	MLF1005GR82KT□□□
1.0	$\pm 10\%$	10	1.0	30	120	0.64	40	MLF1005G1R0KT□□□
1.2	$\pm 10\%$	10	1.0	30	110	0.79	35	MLF1005G1R2KT□□□
1.5	$\pm 10\%$	10	1.0	30	100	0.95	35	MLF1005G1R5KT□□□
1.8	$\pm 10\%$	10	1.0	30	90	1.05	30	MLF1005G1R8KT□□□
2.2	$\pm 10\%$	10	1.0	30	80	1.30	30	MLF1005G2R2KT□□□
0.10	$\pm 10\%$	25	1.0	10	450	0.51	150	MLF1005LR10KT□□□
0.12	$\pm 10\%$	25	1.0	10	400	0.59	140	MLF1005LR12KT□□□
0.15	$\pm 10\%$	25	1.0	10	350	0.63	130	MLF1005LR15KT□□□
0.18	$\pm 10\%$	25	1.0	10	320	0.76	120	MLF1005LR18KT□□□
0.22	$\pm 10\%$	25	1.0	10	290	0.79	110	MLF1005LR22KT□□□
0.27	$\pm 10\%$	25	1.0	10	260	0.91	100	MLF1005LR27KT□□□
0.33	$\pm 10\%$	25	1.0	10	230	1.05	90	MLF1005LR33KT□□□
0.39	$\pm 10\%$	10	1.0	25	210	0.41	50	MLF1005LR39KT□□□
0.47	$\pm 10\%$	10	1.0	25	190	0.42	50	MLF1005LR47KT□□□
0.56	$\pm 10\%$	10	1.0	25	170	0.47	45	MLF1005LR56KT□□□
0.68	$\pm 10\%$	10	1.0	25	150	0.55	40	MLF1005LR68KT□□□
0.82	$\pm 10\%$	10	1.0	25	130	0.59	35	MLF1005LR82KT□□□
1.0	$\pm 10\%$	10	1.0	25	120	0.64	35	MLF1005L1R0KT□□□
1.2	$\pm 10\%$	10	1.0	25	110	0.79	35	MLF1005L1R2KT□□□
1.5	$\pm 10\%$	10	1.0	25	100	0.95	30	MLF1005L1R5KT□□□
1.8	$\pm 10\%$	10	1.0	25	90	1.05	20	MLF1005L1R8KT□□□
2.2	$\pm 10\%$	10	1.0	25	80	1.15	15	MLF1005L2R2KT□□□

* The "□□□" of the Part Number contains the internal code.

○ Measurement equipment

Measurement item	Product No.	Manufacturer
L, Q	4294A+16034G	Agilent Technologies
Self-resonant frequency	E4991A	Agilent Technologies
DC resistance	Type-7561	Yokogawa

* Equivalent measurement equipment may be used.

MLF series **MLF1005 Type**

■ ELECTRICAL CHARACTERISTICS

□ L FREQUENCY CHARACTERISTICS GRAPH

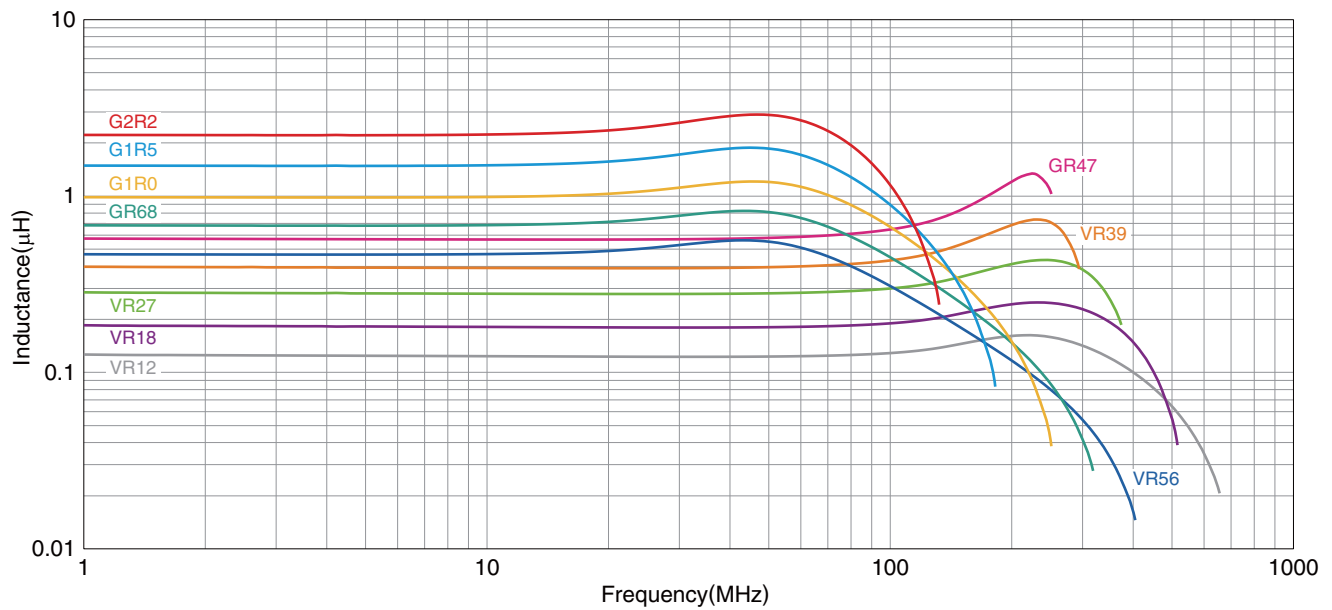
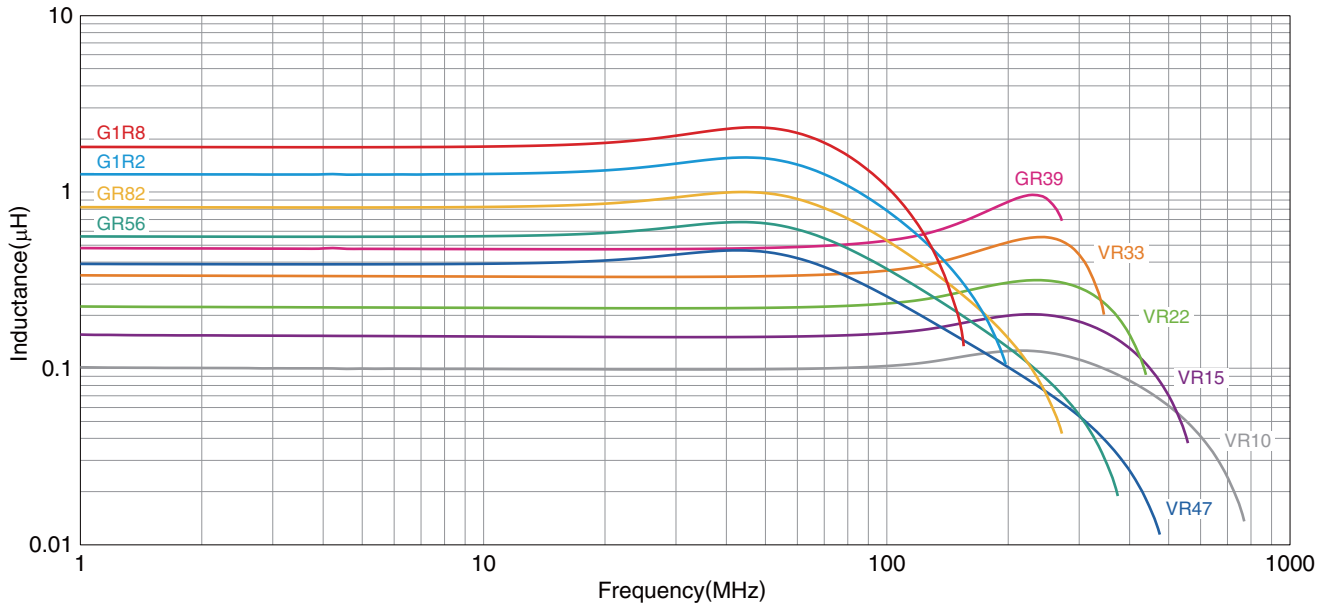

○ Measurement equipment

Product No.	Manufacturer
E4991A+16192A	Agilent Technologies

* Equivalent measurement equipment may be used.

MLF series **MLF1005 Type**

■ ELECTRICAL CHARACTERISTICS

□ L FREQUENCY CHARACTERISTICS GRAPH

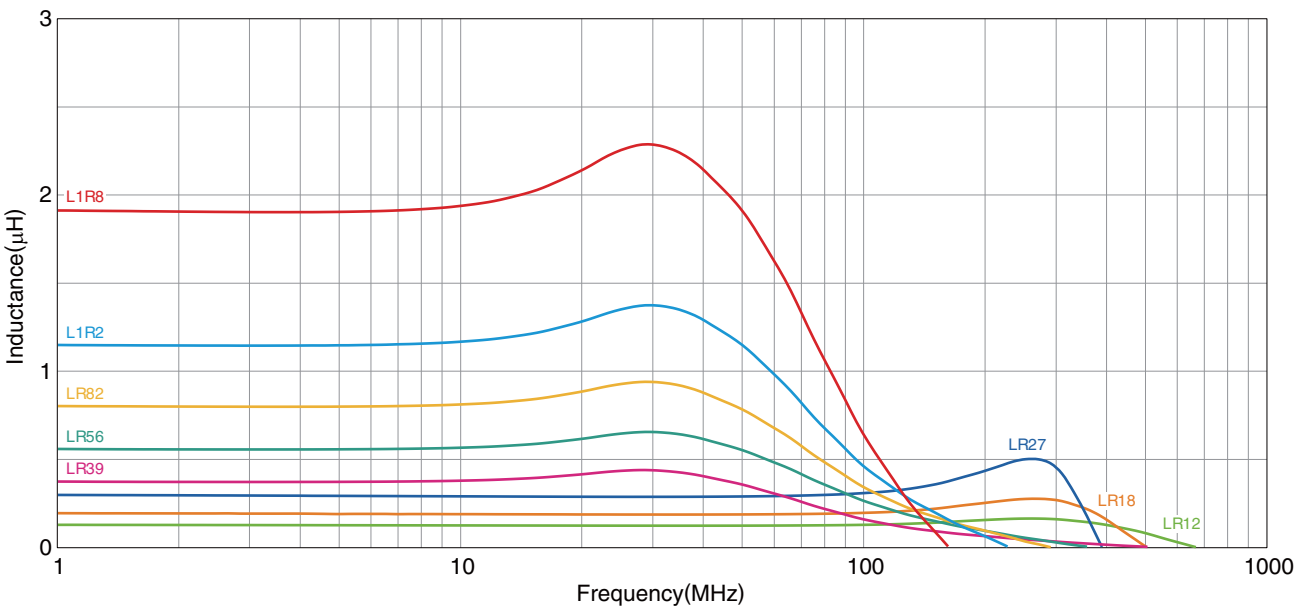
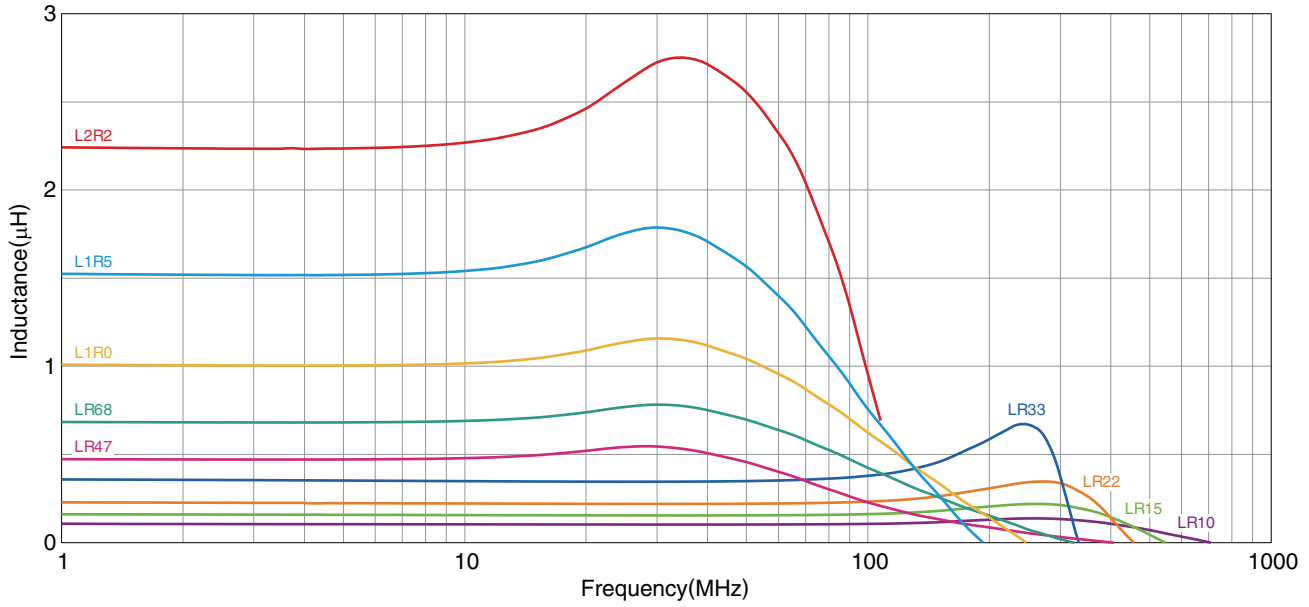

○ Measurement equipment

Product No.	Manufacturer
E4991A+16192A	Agilent Technologies

* Equivalent measurement equipment may be used.

• All specifications are subject to change without notice.

MLF series **MLF1005 Type**

■ ELECTRICAL CHARACTERISTICS

□ Q FREQUENCY CHARACTERISTICS GRAPH

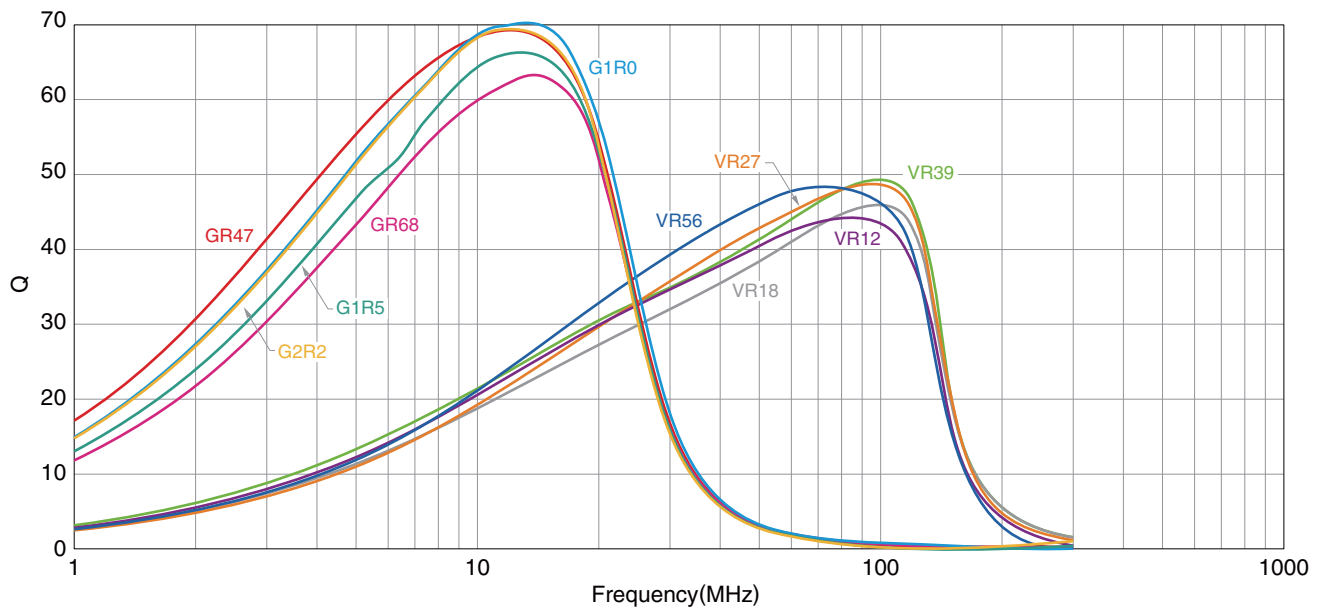
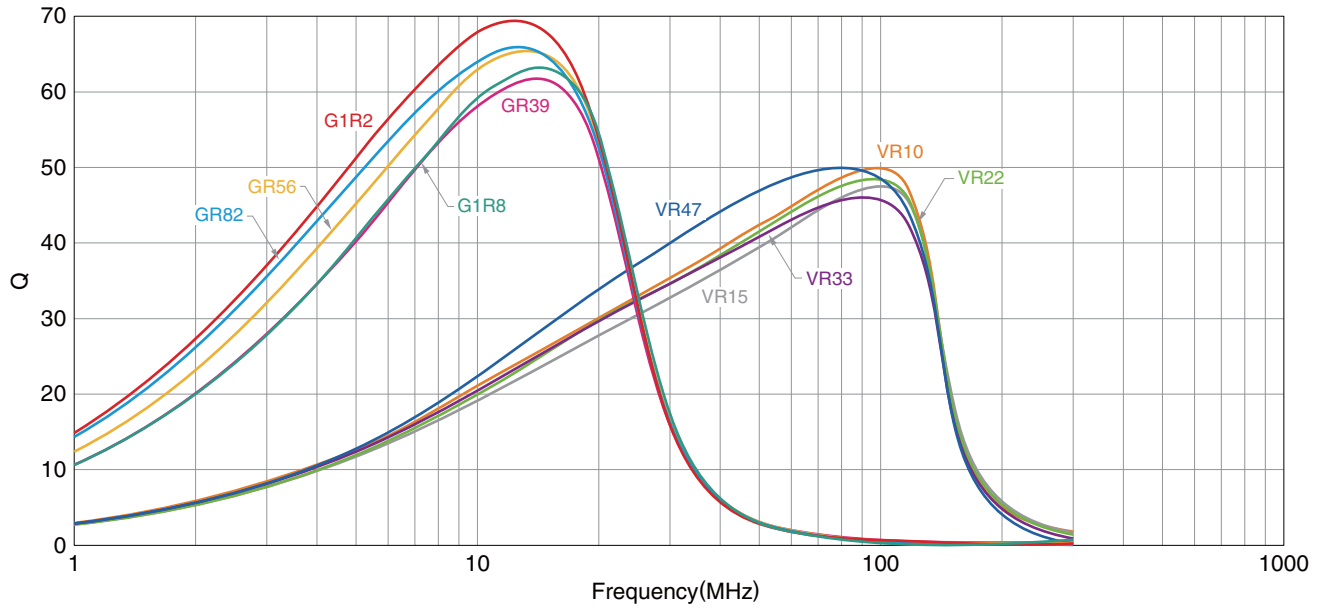

○ Measurement equipment

Product No.	Manufacturer
E4991A+16192A	Agilent Technologies

* Equivalent measurement equipment may be used.

• All specifications are subject to change without notice.

MLF series MLF1005 Type

ELECTRICAL CHARACTERISTICS

Q FREQUENCY CHARACTERISTICS GRAPH

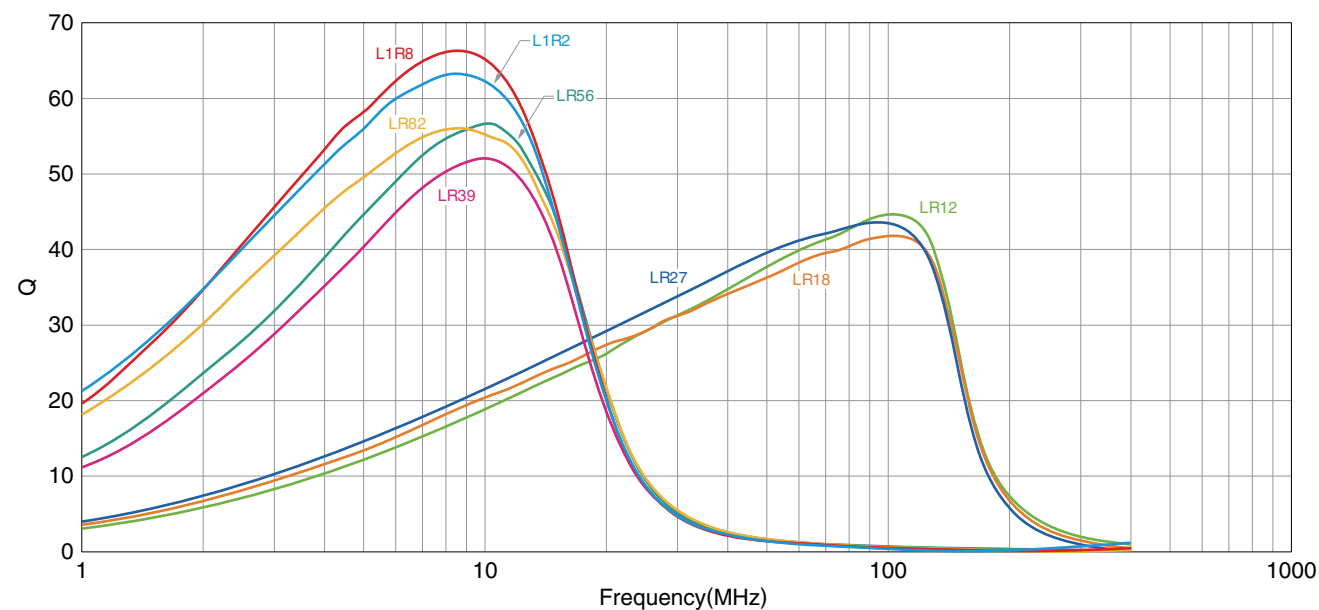
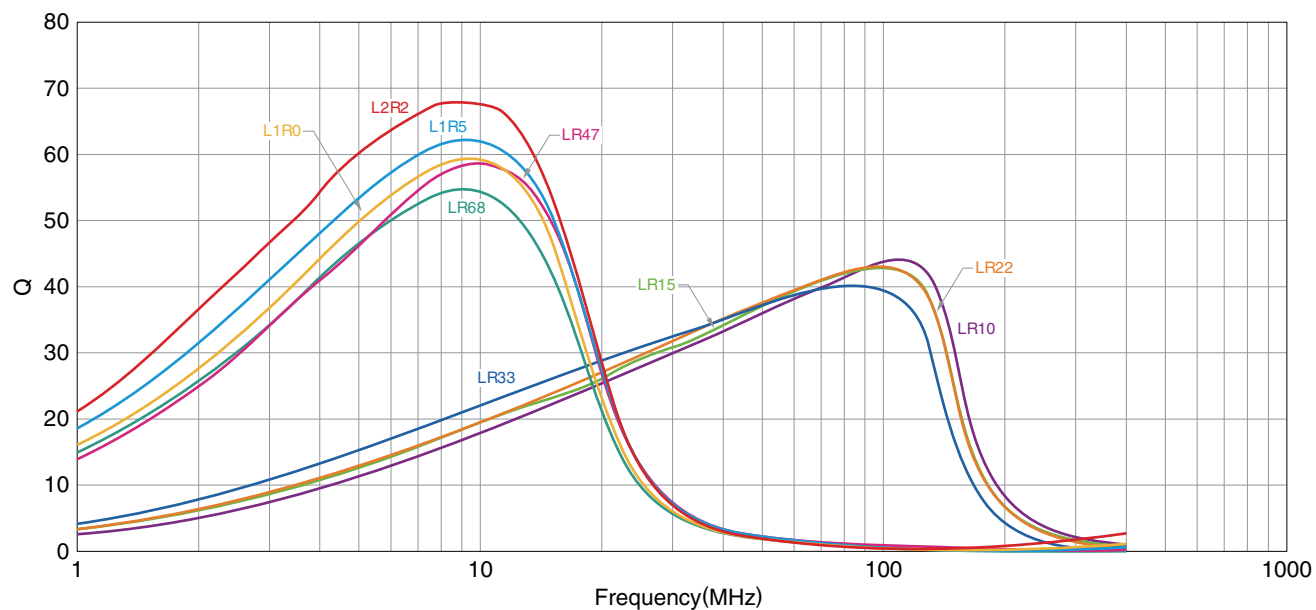

○ Measurement equipment

Product No.	Manufacturer
E4991A+16192A	Agilent Technologies

* Equivalent measurement equipment may be used.

• All specifications are subject to change without notice.

MLF series

MLF1608 Type



■ SHAPE & DIMENSIONS

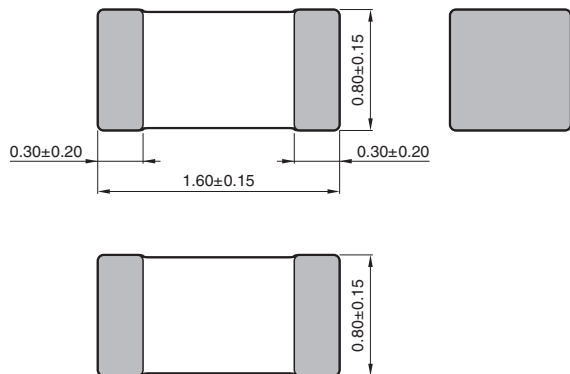

Dimensions in mm

■ RECOMMENDED LAND PATTERN

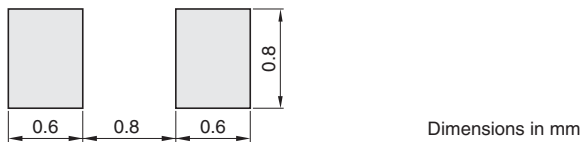

Dimensions in mm

• All specifications are subject to change without notice.

MLF series **MLF1608 Type**

■ ELECTRICAL CHARACTERISTICS

□ CHARACTERISTICS SPECIFICATION TABLE

L (μ H)	Q Tolerance	Q		L, Q measuring conditions		Self-resonant frequency(MHz)		DC resistance (Ω)		Rated current (mA)	Part No.*
		min.	typ.	Frequency (MHz)	Current (mA)	min.	typ.	max.	typ.	max.	
0.047	$\pm 20\%$	10	20	50	1.0	600	900	0.20	0.10	200	MLF1608D47NMT□□□
0.068	$\pm 20\%$	10	20	50	1.0	550	700	0.30	0.15	200	MLF1608D68NMT□□□
0.082	$\pm 20\%$	10	20	50	1.0	500	650	0.30	0.15	200	MLF1608D82NMT□□□
0.10	$\pm 10\%$	15	25	25	1.0	450	600	0.35	0.20	200	MLF1608DR10KT□□□
0.12	$\pm 10\%$	15	25	25	1.0	400	550	0.40	0.20	200	MLF1608DR12KT□□□
0.15	$\pm 10\%$	15	25	25	1.0	350	500	0.45	0.25	200	MLF1608DR15KT□□□
0.18	$\pm 10\%$	15	25	25	1.0	320	450	0.50	0.25	150	MLF1608DR18KT□□□
0.22	$\pm 10\%$	15	25	25	1.0	290	400	0.55	0.30	150	MLF1608DR22KT□□□
0.27	$\pm 10\%$	15	25	25	1.0	260	350	0.60	0.35	150	MLF1608DR27KT□□□
0.33	$\pm 10\%$	15	25	25	1.0	230	320	0.75	0.40	100	MLF1608DR33KT□□□
0.39	$\pm 10\%$	15	25	25	1.0	210	290	0.85	0.45	100	MLF1608DR39KT□□□
0.47	$\pm 10\%$	15	30	25	1.0	190	260	0.95	0.50	100	MLF1608DR47KT□□□
0.56	$\pm 10\%$	15	30	25	1.0	170	230	1.05	0.55	100	MLF1608DR56KT□□□
0.68	$\pm 10\%$	15	30	25	1.0	150	210	1.25	0.65	70	MLF1608DR68KT□□□
0.82	$\pm 10\%$	15	30	25	1.0	130	190	1.40	0.75	70	MLF1608DR82KT□□□
1.0	$\pm 10\%$	35	50	10	1.0	120	170	0.50	0.25	50	MLF1608A1R0KT□□□
1.2	$\pm 10\%$	35	50	10	1.0	110	150	0.65	0.25	50	MLF1608A1R2KT□□□
1.5	$\pm 10\%$	35	55	10	1.0	100	140	0.70	0.30	50	MLF1608A1R5KT□□□
1.8	$\pm 10\%$	35	55	10	1.0	90	130	0.85	0.35	50	MLF1608A1R8KT□□□
2.2	$\pm 10\%$	35	55	10	1.0	80	120	1.00	0.45	30	MLF1608A2R2KT□□□
2.7	$\pm 10\%$	35	55	10	1.0	70	110	1.15	0.50	30	MLF1608A2R7KT□□□
3.3	$\pm 10\%$	35	60	10	1.0	65	100	1.30	0.55	30	MLF1608A3R3KT□□□
3.9	$\pm 10\%$	35	60	10	1.0	60	90	1.45	0.65	30	MLF1608A3R9KT□□□
4.7	$\pm 10\%$	35	60	10	1.0	55	80	1.60	0.75	30	MLF1608A4R7KT□□□
5.6	$\pm 10\%$	35	60	4	0.1	45	70	1.10	0.55	15	MLF1608E5R6KT□□□
6.8	$\pm 10\%$	35	60	4	0.1	40	60	1.30	0.65	15	MLF1608E6R8KT□□□
8.2	$\pm 10\%$	35	60	4	0.1	35	55	1.50	0.80	10	MLF1608E8R2KT□□□
10	$\pm 10\%$	30	55	2	0.1	30	50	1.70	1.00	10	MLF1608E100KT□□□
12	$\pm 10\%$	30	55	2	0.1	25	45	1.80	1.20	10	MLF1608E120KT□□□
15	$\pm 10\%$	20	40	1	0.1	22	42	1.50	0.80	2	MLF1608C150KT□□□
18	$\pm 10\%$	20	40	1	0.1	20	40	1.60	0.85	2	MLF1608C180KT□□□
22	$\pm 10\%$	20	40	1	0.1	18	38	1.70	0.90	2	MLF1608C220KT□□□
27	$\pm 10\%$	20	40	1	0.1	15	35	1.80	1.20	2	MLF1608C270KT□□□
33	$\pm 10\%$	20	40	1	0.1	10	30	2.20	1.40	2	MLF1608C330KT□□□

* The "□□□" of the Part Number contains the internal code.

○ Measurement equipment

Measurement item	Product No.	Manufacturer
L, Q	4294A+16034G	Agilent Technologies
Self-resonant frequency	E4991A	Agilent Technologies
DC resistance	Type-7561	Yokogawa

* Equivalent measurement equipment may be used.

MLF series MLF1608 Type

ELECTRICAL CHARACTERISTICS

FREQUENCY CHARACTERISTICS GRAPH

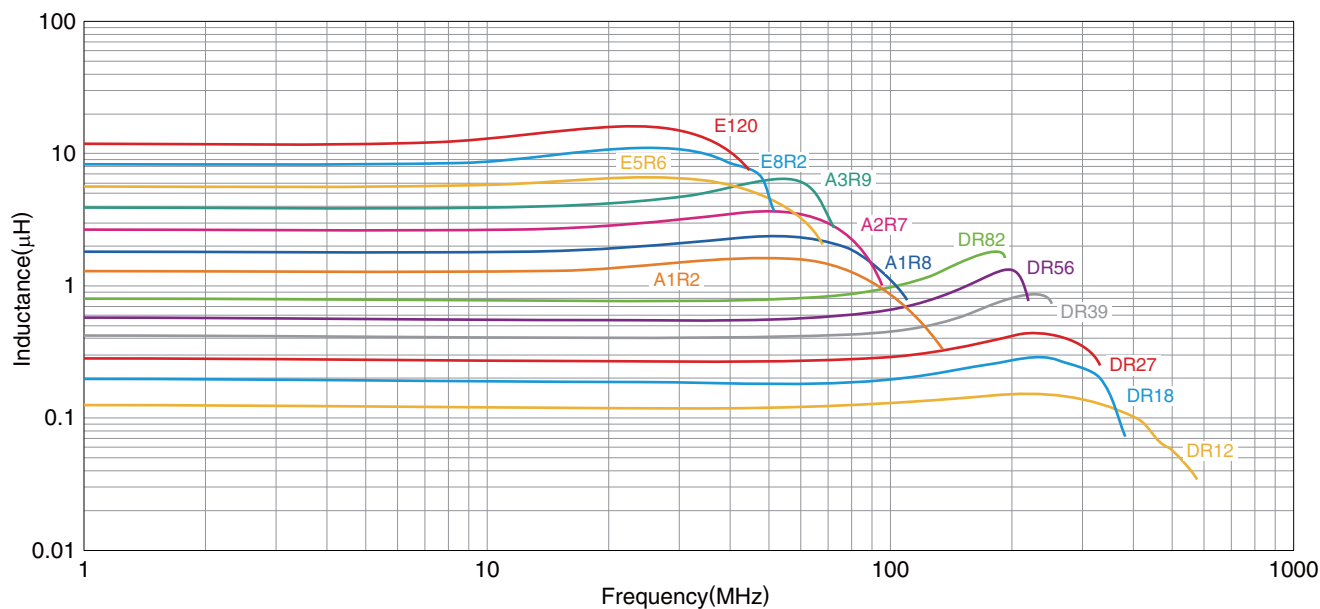
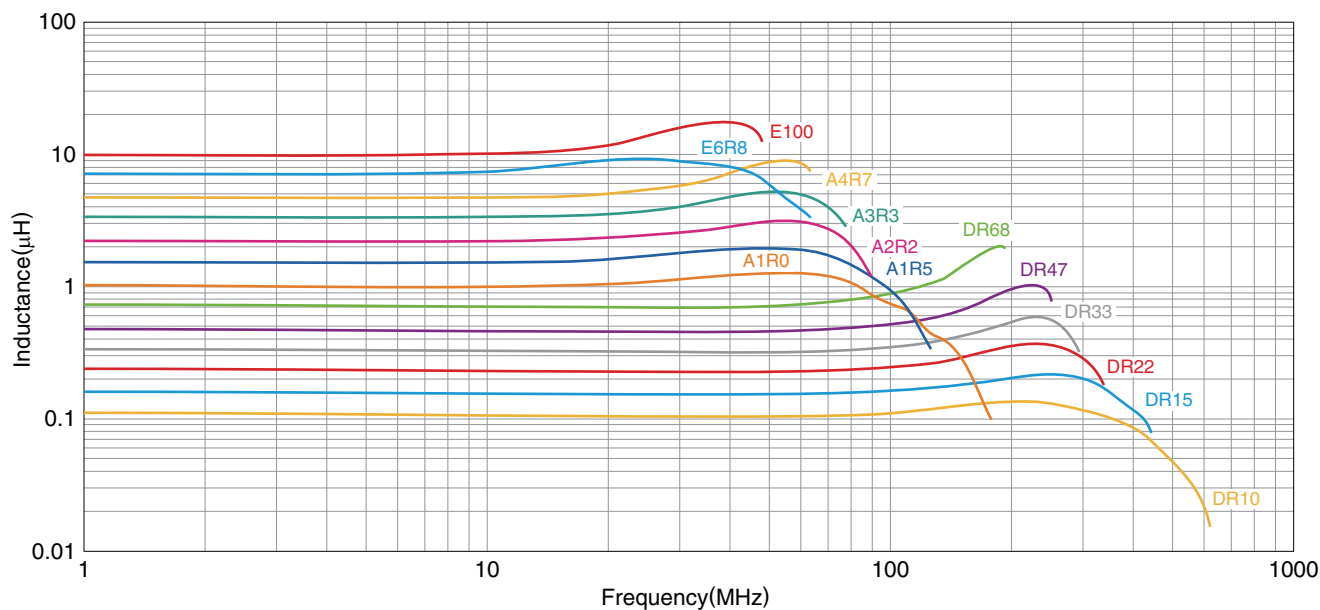

○ Measurement equipment

Product No.	Manufacturer
E4991A+16192A	Agilent Technologies

* Equivalent measurement equipment may be used.

MLF series **MLF1608 Type**

■ ELECTRICAL CHARACTERISTICS

□ L FREQUENCY CHARACTERISTICS GRAPH

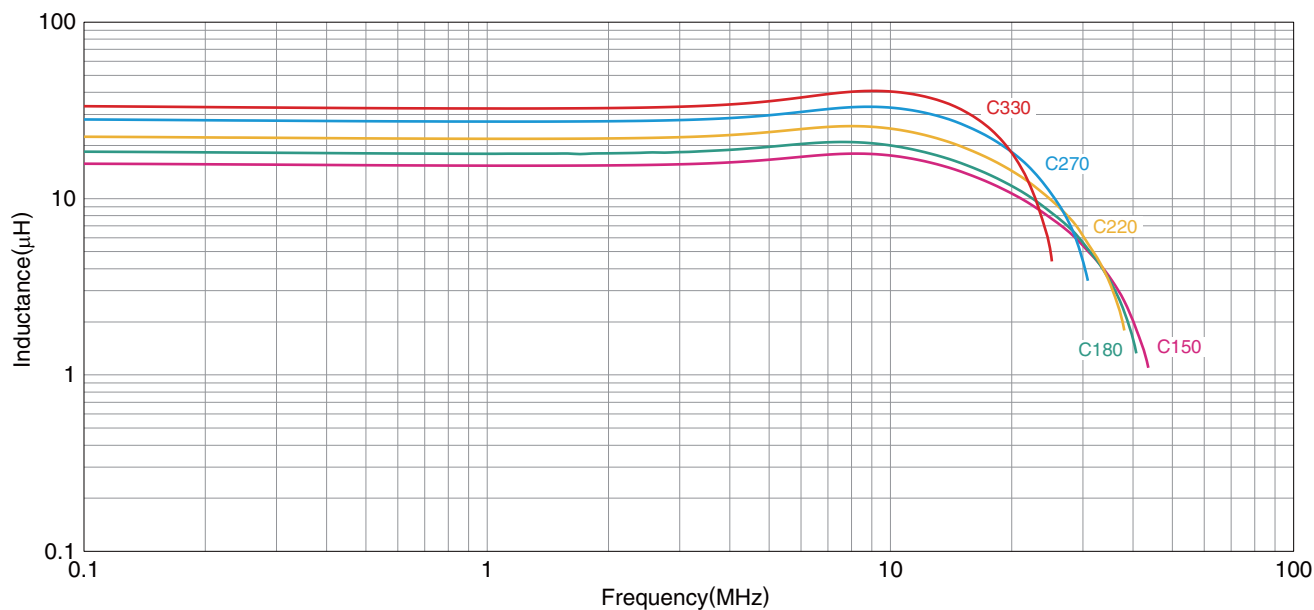

○ Measurement equipment

Product No.	Manufacturer
4294A+16034G	Agilent Technologies

* Equivalent measurement equipment may be used.

MLF series **MLF1608 Type**

■ ELECTRICAL CHARACTERISTICS

□ Q FREQUENCY CHARACTERISTICS GRAPH

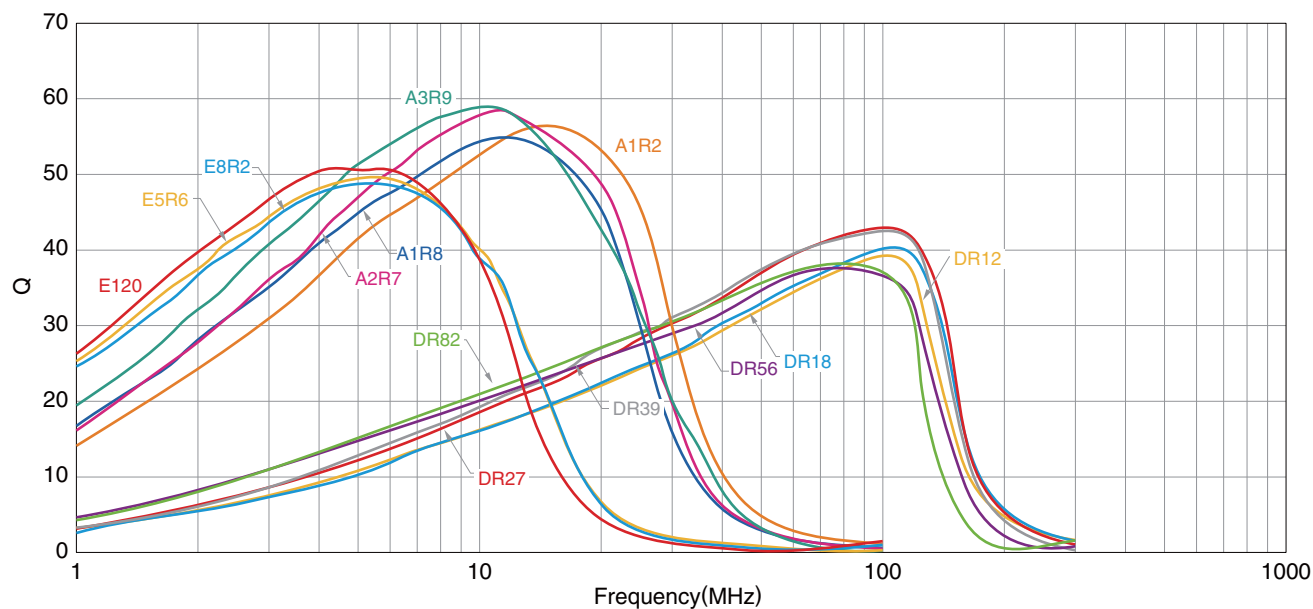
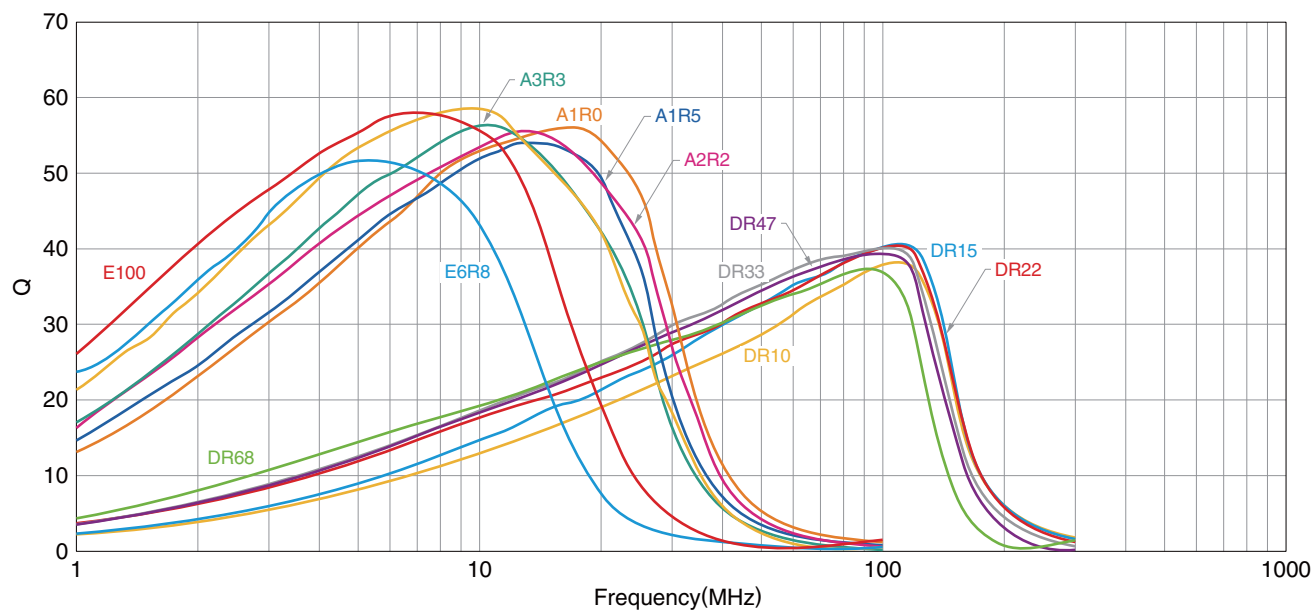

○ Measurement equipment

Product No.	Manufacturer
E4991A+16192A	Agilent Technologies

* Equivalent measurement equipment may be used.

• All specifications are subject to change without notice.

MLF series **MLF1608 Type**

■ ELECTRICAL CHARACTERISTICS

□ Q FREQUENCY CHARACTERISTICS GRAPH

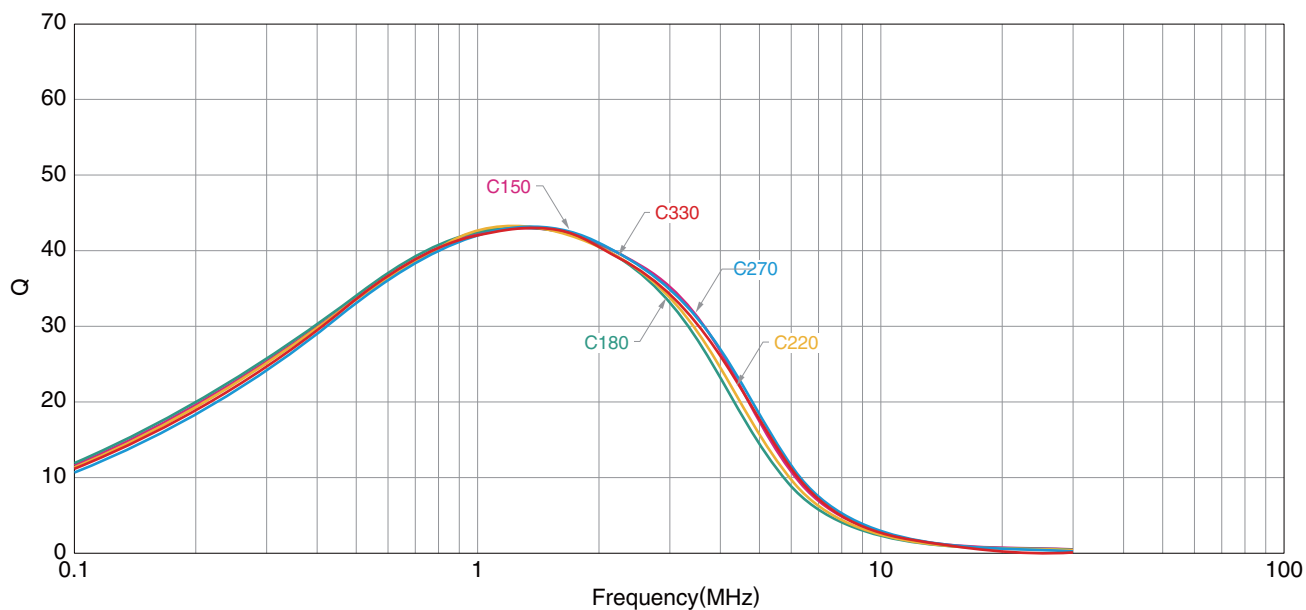

○ Measurement equipment

Product No.	Manufacturer
4294A+16034G	Agilent Technologies

* Equivalent measurement equipment may be used.

• All specifications are subject to change without notice.

MLF series

MLF2012 Type



SHAPE & DIMENSIONS

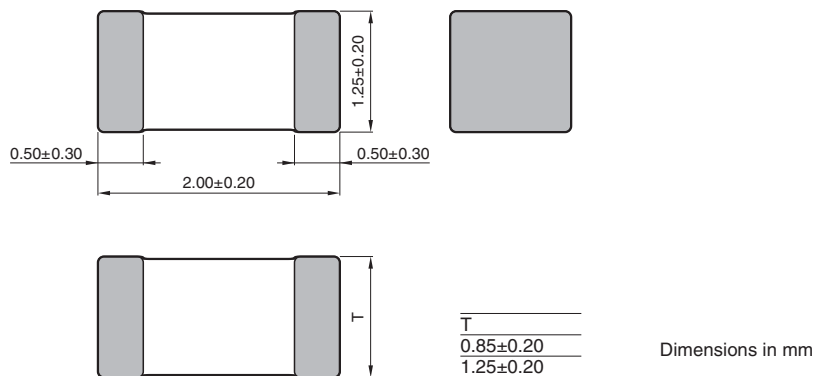

RECOMMENDED LAND PATTERN

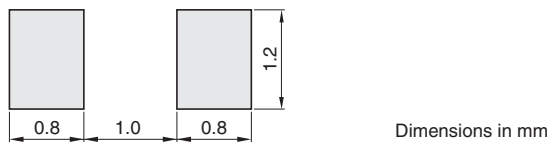

• All specifications are subject to change without notice.

MLF series **MLF2012 Type**

■ ELECTRICAL CHARACTERISTICS

□ CHARACTERISTICS SPECIFICATION TABLE

L (μ H)	Q Tolerance	Q		L, Q measuring conditions		Self-resonant frequency(MHz)		DC resistance (Ω)		Rated current (mA) max.	Thickness T (mm)	Part No.*
		min.	typ.	Frequency (MHz)	Current (mA)	min.	typ.	max.	typ.			
0.047	$\pm 20\%$	15	25	50	1.0	550	700	0.10	0.05	300	0.85	MLF2012D47NMT□□□
0.068	$\pm 20\%$	15	25	50	1.0	500	600	0.15	0.08	300	0.85	MLF2012D68NMT□□□
0.082	$\pm 20\%$	15	25	50	1.0	450	550	0.15	0.08	300	0.85	MLF2012D82NMT□□□
0.10	$\pm 10\%$	20	30	25	1.0	400	500	0.15	0.10	300	0.85	MLF2012DR10KT□□□
0.12	$\pm 10\%$	20	30	25	1.0	360	450	0.20	0.12	300	0.85	MLF2012DR12KT□□□
0.15	$\pm 10\%$	20	30	25	1.0	320	410	0.20	0.13	300	0.85	MLF2012DR15KT□□□
0.18	$\pm 10\%$	20	30	25	1.0	280	370	0.25	0.15	300	0.85	MLF2012DR18KT□□□
0.22	$\pm 10\%$	20	30	25	1.0	250	330	0.30	0.16	250	0.85	MLF2012DR22KT□□□
0.27	$\pm 10\%$	20	30	25	1.0	220	300	0.35	0.18	250	0.85	MLF2012DR27KT□□□
0.33	$\pm 10\%$	20	30	25	1.0	200	270	0.40	0.23	250	0.85	MLF2012DR33KT□□□
0.39	$\pm 10\%$	25	35	25	1.0	180	250	0.45	0.25	200	0.85	MLF2012DR39KT□□□
0.47	$\pm 10\%$	25	35	25	1.0	160	230	0.50	0.25	200	1.25	MLF2012DR47KT□□□
0.56	$\pm 10\%$	25	35	25	1.0	150	210	0.55	0.30	150	1.25	MLF2012DR56KT□□□
0.68	$\pm 10\%$	25	35	25	1.0	140	190	0.60	0.35	150	1.25	MLF2012DR68KT□□□
0.82	$\pm 10\%$	25	35	25	1.0	130	170	0.65	0.40	150	1.25	MLF2012DR82KT□□□
1.0	$\pm 10\%$	45	55	10	1.0	120	160	0.30	0.15	80	0.85	MLF2012A1R0KT□□□
1.2	$\pm 10\%$	45	55	10	1.0	110	150	0.35	0.15	80	0.85	MLF2012A1R2KT□□□
1.5	$\pm 10\%$	45	60	10	1.0	100	140	0.40	0.18	80	0.85	MLF2012A1R5KT□□□
1.8	$\pm 10\%$	45	60	10	1.0	90	130	0.45	0.20	80	0.85	MLF2012A1R8KT□□□
2.2	$\pm 10\%$	45	60	10	1.0	80	120	0.50	0.22	50	0.85	MLF2012A2R2KT□□□
2.7	$\pm 10\%$	45	70	10	1.0	70	100	0.55	0.25	50	1.25	MLF2012A2R7KT□□□
3.3	$\pm 10\%$	45	70	10	1.0	60	90	0.60	0.28	50	1.25	MLF2012A3R3KT□□□
3.9	$\pm 10\%$	45	70	10	1.0	55	80	0.65	0.30	30	1.25	MLF2012A3R9KT□□□
4.7	$\pm 10\%$	45	70	10	1.0	50	70	0.70	0.35	30	1.25	MLF2012A4R7KT□□□
5.6	$\pm 10\%$	50	75	4	0.1	45	65	0.60	0.30	15	1.25	MLF2012E5R6KT□□□
6.8	$\pm 10\%$	50	75	4	0.1	40	60	0.65	0.32	15	1.25	MLF2012E6R8KT□□□
8.2	$\pm 10\%$	50	75	4	0.1	35	55	0.70	0.35	15	1.25	MLF2012E8R2KT□□□
10	$\pm 10\%$	50	75	2	0.1	30	50	0.80	0.40	15	1.25	MLF2012E100KT□□□
12	$\pm 10\%$	50	75	2	0.1	25	45	0.90	0.50	15	1.25	MLF2012E120KT□□□
15	$\pm 10\%$	30	45	1	0.1	22	40	0.70	0.35	5	1.25	MLF2012C150KT□□□
18	$\pm 10\%$	30	45	1	0.1	20	38	0.80	0.38	5	1.25	MLF2012C180KT□□□
22	$\pm 10\%$	30	45	1	0.1	18	35	0.90	0.45	5	1.25	MLF2012C220KT□□□
27	$\pm 10\%$	30	45	1	0.1	17	33	1.00	0.50	5	1.25	MLF2012C270KT□□□
33	$\pm 10\%$	30	45	0.4	0.1	15	28	1.10	0.55	5	1.25	MLF2012C330KT□□□
39	$\pm 10\%$	35	55	2	0.1	13	23	2.40	1.30	4	1.25	MLF2012K390KT□□□
47	$\pm 10\%$	35	55	2	0.1	11	20	2.70	1.60	4	1.25	MLF2012K470KT□□□
56	$\pm 10\%$	35	55	2	0.1	10	18	2.80	1.80	4	1.25	MLF2012K560KT□□□
68	$\pm 10\%$	25	45	1	0.1	9	16	2.90	2.00	2	1.25	MLF2012C680KT□□□
82	$\pm 10\%$	25	45	1	0.1	8	14	3.00	2.40	2	1.25	MLF2012C820KT□□□
100	$\pm 10\%$	25	45	1	0.1	7	12	3.10	2.50	2	1.25	MLF2012C101KT□□□

* The "□□□" of the Part Number contains the internal code.

○ Measurement equipment

Measurement item	Product No.	Manufacturer
L, Q	4294A+16034G	Agilent Technologies
Self-resonant frequency	E4991A	Agilent Technologies
DC resistance	Type-7561	Yokogawa

* Equivalent measurement equipment may be used.

MLF series **MLF2012 Type**

■ ELECTRICAL CHARACTERISTICS

□ L FREQUENCY CHARACTERISTICS GRAPH

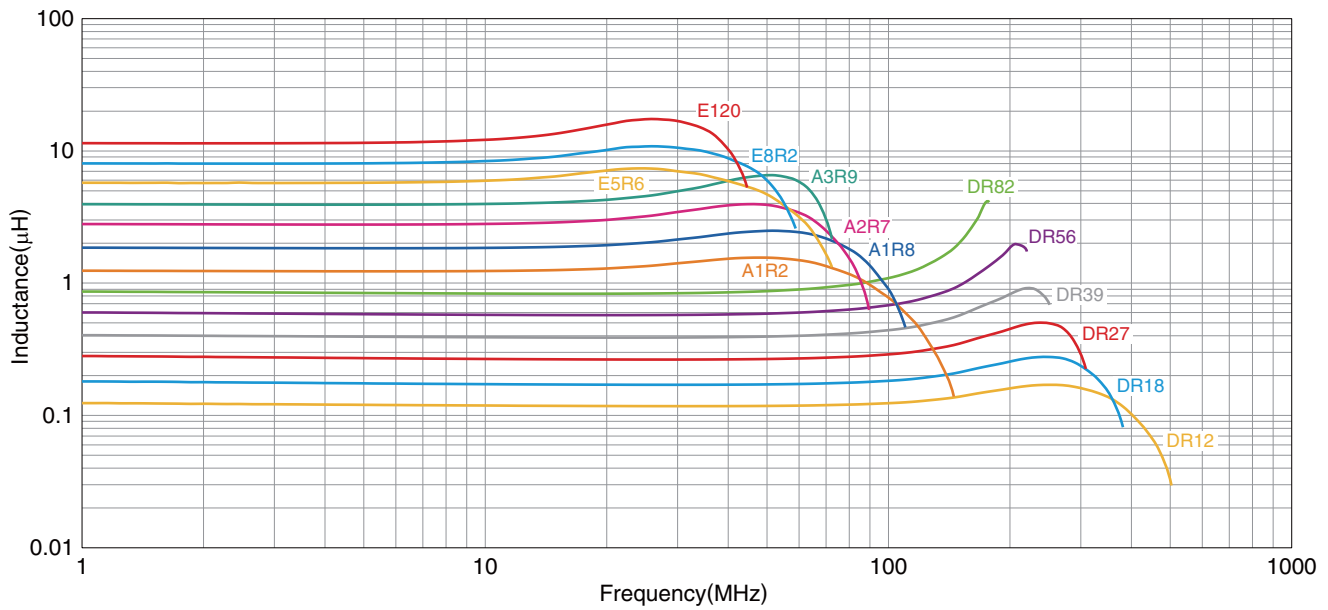
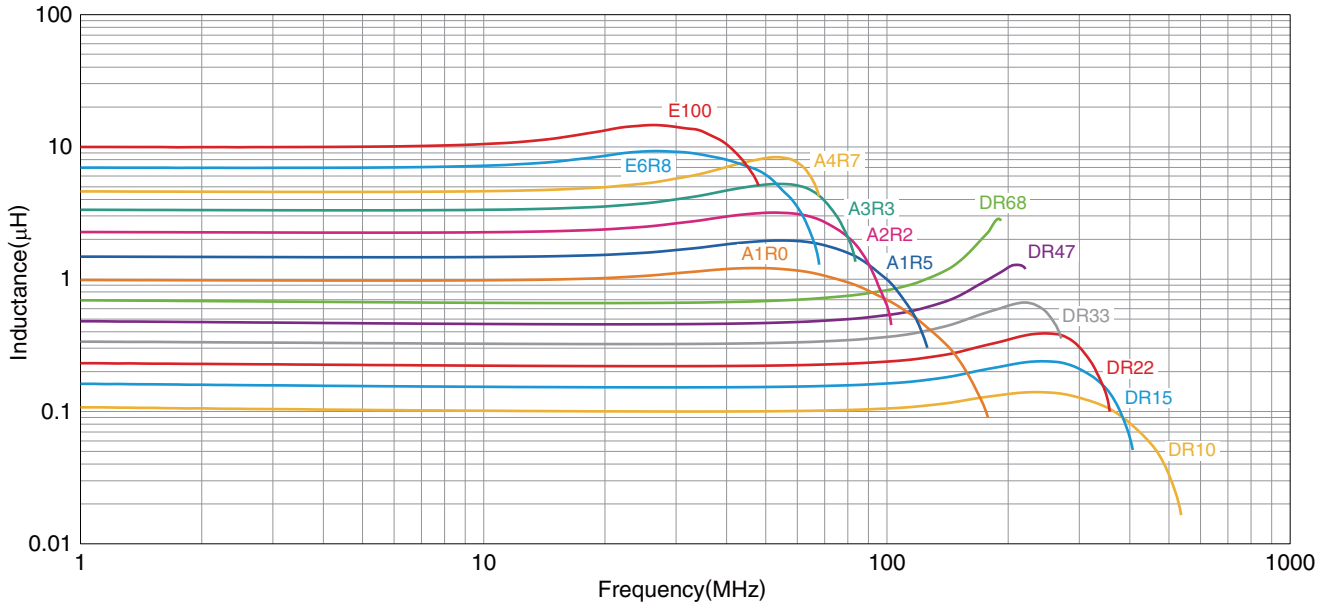

○ Measurement equipment

Product No.	Manufacturer
E4991A+16192A	Agilent Technologies

* Equivalent measurement equipment may be used.

• All specifications are subject to change without notice.

MLF series **MLF2012 Type**

■ ELECTRICAL CHARACTERISTICS

□ L FREQUENCY CHARACTERISTICS GRAPH

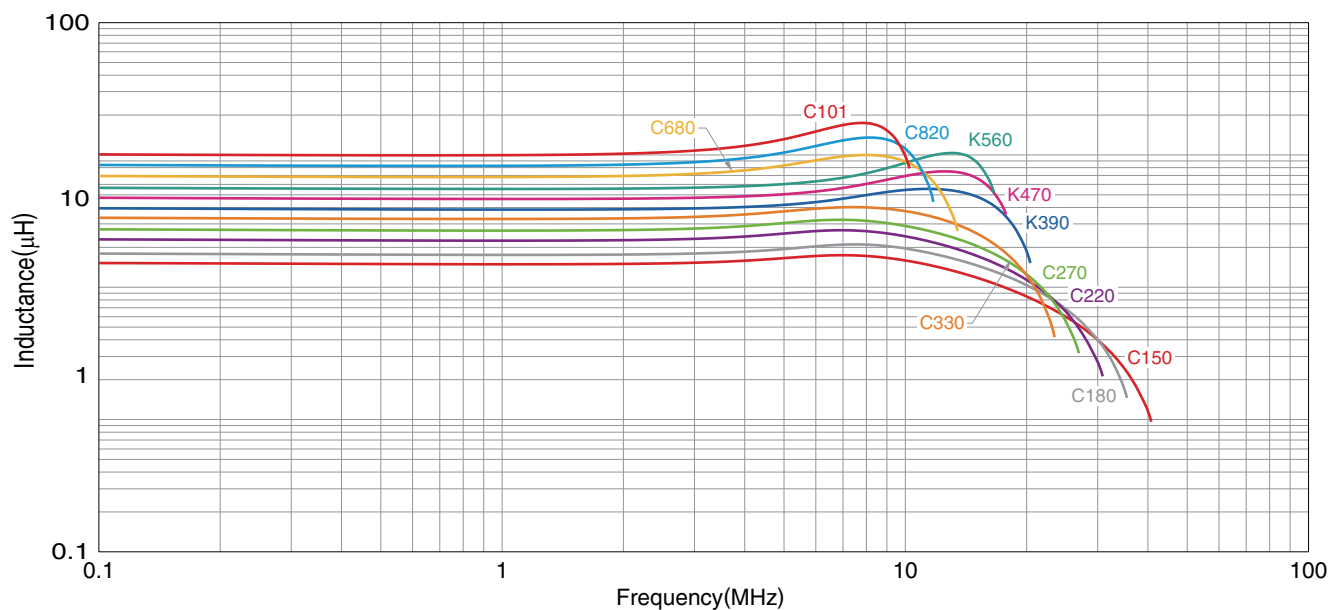

○ Measurement equipment

Product No.	Manufacturer
4294A+16034G	Agilent Technologies

* Equivalent measurement equipment may be used.

MLF series MLF2012 Type

ELECTRICAL CHARACTERISTICS

Q FREQUENCY CHARACTERISTICS GRAPH

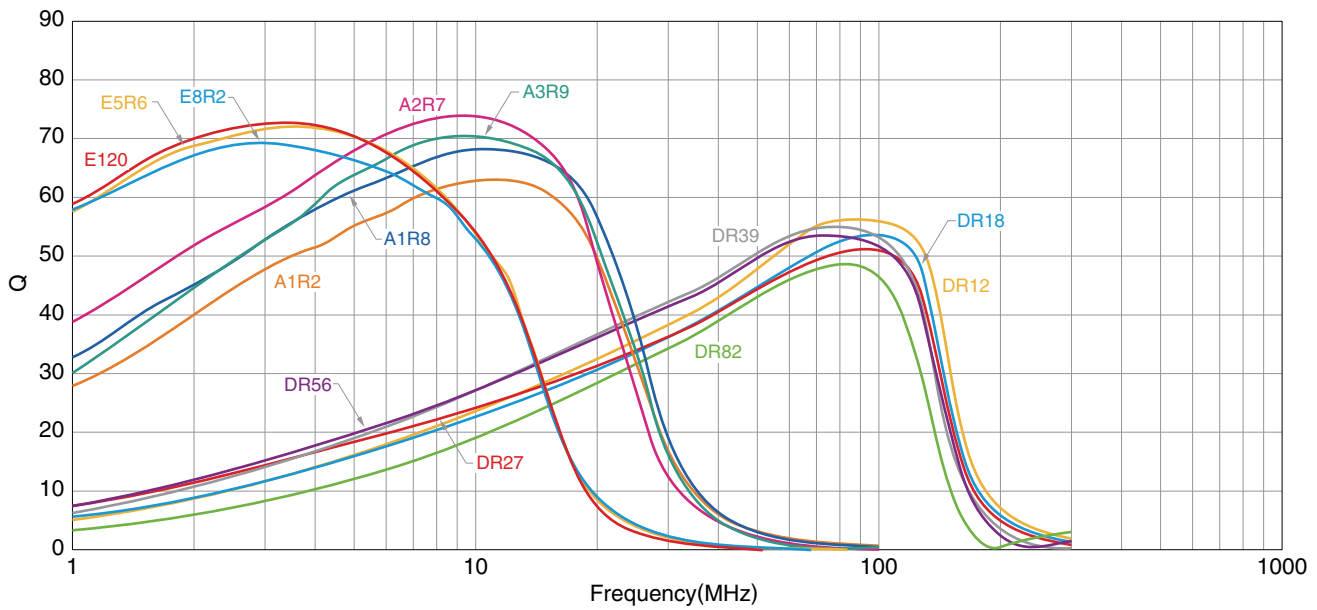
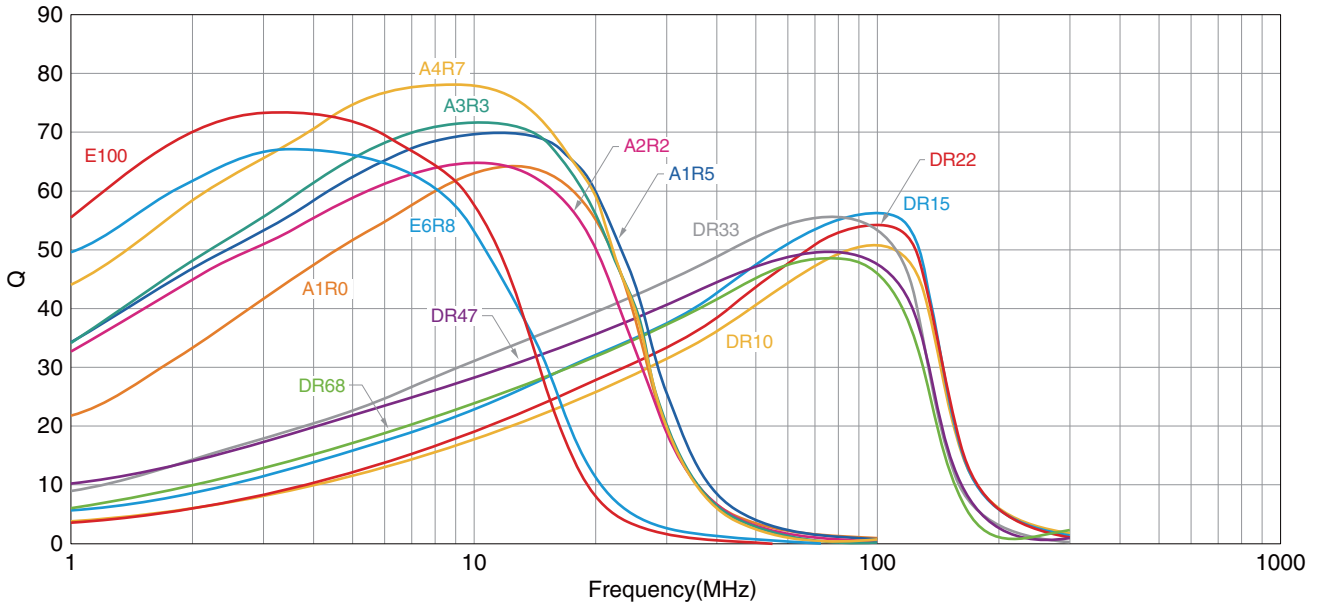

○ Measurement equipment

Product No.	Manufacturer
E4991A+16192A	Agilent Technologies

* Equivalent measurement equipment may be used.

• All specifications are subject to change without notice.

MLF series **MLF2012 Type**

Q FREQUENCY CHARACTERISTICS GRAPH

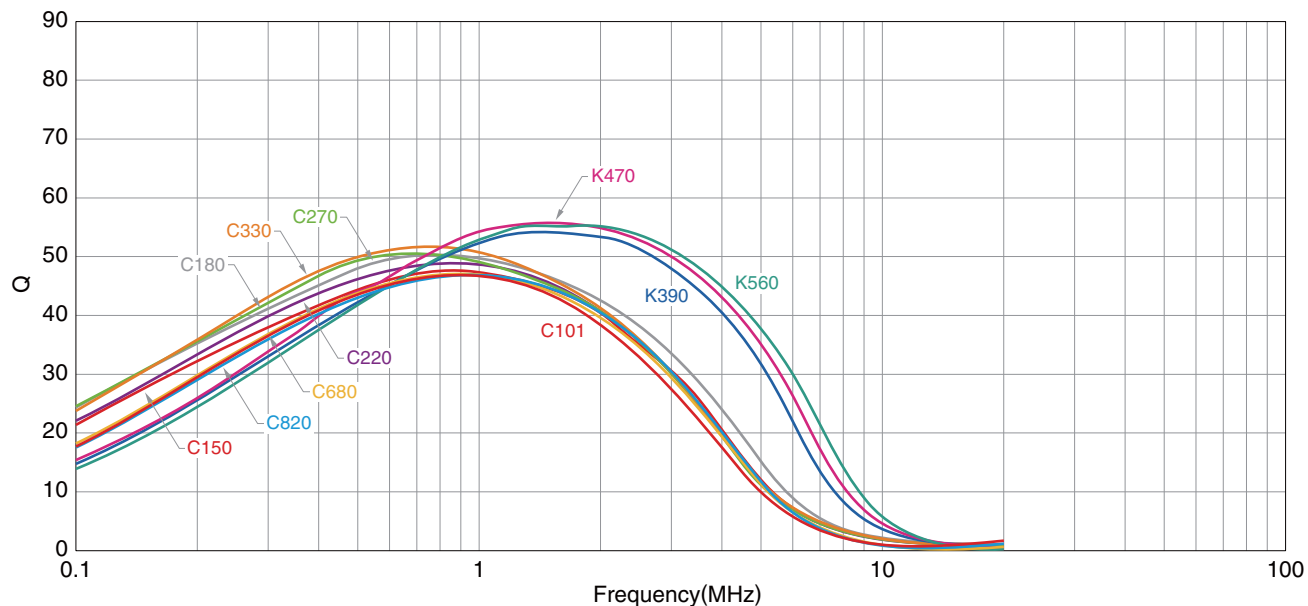

○ Measurement equipment

Product No.	Manufacturer
4294A+16034G	Agilent Technologies

* Equivalent measurement equipment may be used.

• All specifications are subject to change without notice.

MLF series

Packaging Style

REEL DIMENSIONS

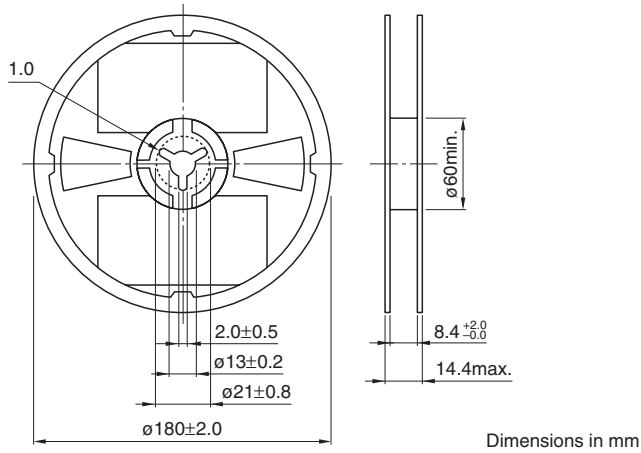

TAPE DIMENSIONS

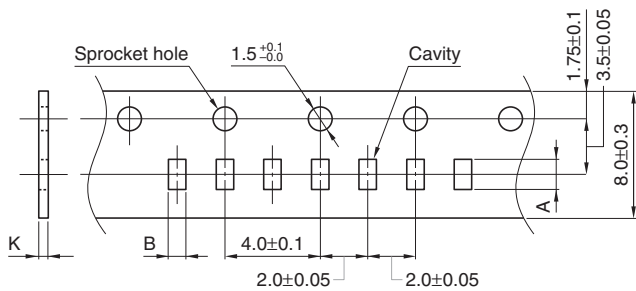

Type	A	B	K
MLF1005	1.15±0.1	0.65±0.1	0.8 max.
MLF1608	1.9±0.2	1.1±0.2	1.1 max.
MLF2012	t=0.85	2.3±0.2	1.5±0.2
	t=1.25	2.3±0.2	1.5±0.2

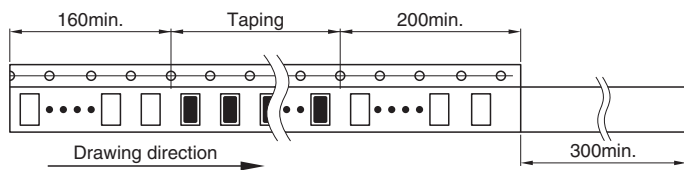

Dimensions in mm

• All specifications are subject to change without notice.

Mouser Electronics

Authorized Distributor

Click to View Pricing, Inventory, Delivery & Lifecycle Information:

TDK:

[MLF1608A1R0J](#) [MLF1608A1R2J](#) [MLF1608A1R5J](#) [MLF1608A1R8J](#) [MLF1608A2R2J](#) [MLF1608A3R9J](#)
[MLF1608DR10J](#) [MLF1608DR12J](#) [MLF1608DR15J](#) [MLF1608DR18J](#) [MLF1608DR27J](#) [MLF1608DR33J](#)
[MLF1608DR39J](#) [MLF1608DR47J](#) [MLF1608DR56J](#) [MLF1608E100J](#) [MLF1608E120J](#) [MLF1608E6R8J](#)
[MLF1608E8R2J](#) [MLF2012A1R2K](#) [MLF2012A2R2K](#) [MLF2012A4R7K](#) [MLF2012C101K](#) [MLF2012C220K](#)
[MLF2012C270K](#) [MLF2012C330K](#) [MLF2012C680K](#) [MLF2012C820K](#) [MLF2012D68NM](#) [MLF2012D82NM](#)
[MLF2012DR10K](#) [MLF2012DR15K](#) [MLF2012DR22K](#) [MLF2012DR39K](#) [MLF2012DR56K](#) [MLF2012DR82K](#)
[MLF2012E100K](#) [MLF2012K560K](#) [MLF2012A1R0J](#) [MLF2012A1R8J](#) [MLF2012A4R7J](#) [MLF2012DR15J](#)
[MLF2012DR33J](#) [MLF2012DR56J](#) [MLF2012DR82J](#) [MLF2012E100J](#) [MLF2012E120J](#) [MLF2012E6R8J](#)
[MLF2012E8R2J](#) [MLF1005VR47J](#) [MLF1005VR15J](#) [MLF1005VR27J](#) [MLF1005VR18J](#) [MLF1005VR22J](#)
[MLF1005VR39J](#) [MLF1005VR33J](#) [MLF1005VR56J](#) [MLF1005VR39KT](#) [MLF1005VR47KT](#) [MLF1005VR10KT](#)
[MLF1005G1R8KT](#) [MLF1005VR15KT](#) [MLF1005GR56KT](#) [MLF1005VR22KT](#) [MLF1005GR47KT](#) [MLF1005G1R0KT](#)
[MLF1005VR33KT](#) [MLF1005VR12KT](#) [MLF1005VR18KT](#) [MLF1005VR27KT](#) [MLF1005G1R2KT](#) [MLF1005GR68KT](#)
[MLF1005GR82KT](#) [MLF1005G2R2KT](#) [MLF1005G1R5KT](#) [MLF1005VR56KT](#)