

TOSHIBA

FILE NO. 060-200509

SERVICE MANUAL

LCD Color Television



42WL55A
42WL55E
42WL55R
42WL55T

TABLE OF CONTENTS

SERVICE SAFETY PRECAUTIONS	3
HANDLING THE LCD MODULE	5
SERVICE MODE	7
LOCATION OF CONTROLS	12
LAYOUT OF MAJOR BOARDS	14
MECHANICAL DISASSEMBLY	15
EXPLODED VIEW	17
PACKING DISASSEMBLY	19
CHASSIS AND CABINET REPLACEMENT PARTS LIST	20
PC BOARDS TOP & BOTTOM VIEW	27
CIRCUIT BLOCK DIAGRAM	39
SPECIFICATIONS	43
APPENDIX:	
SCHEMATIC DIAGRAM	



SERVICE SAFETY PRECAUTIONS











- The caution items shown here describe major safety issues and should always be observed.
- The meanings of the various indications are as follows.

 WARNING	Indicates a hypothetical situation in which service personnel and nearby third parties, or even end users due to a product defect after the service operation is completed, could possibly be in danger of injury or even death in the event of operational error.
 CAUTION	Indicates a hypothetical situation in which service personnel and nearby third parties, or even end users after the service operation is completed, could possibly be in danger of injury, or where there could be physical damage in the event of operational error.

* Physical damage means major damage to a home, furnishings and other possessions.

Examples of marks

 SHOCK HAZARD	The Δ indicates caution (including danger and warning). The actual meaning of this caution is indicated inside the Δ or nearby illustrations or text. The example shown to the left indicates the danger of "electrical shock".
 PROHIBIT DISASSEMBLING	The \ominus indicates a forbidden action. The actual meaning of this caution is indicated inside the \ominus or nearby illustrations or text. The example shown to the left indicates that disassembly is forbidden.
 UNPULUG	The \bullet indicates a forced action (an action that must be performed). The actual meaning of this forced action is indicated by \bullet or nearby illustrations or text. The example shown to the left indicates that the power plug must be disconnected.

	 WARNING
 KEEP CHILDREN AWAY	<ul style="list-style-type: none"> Always advise users to keep children away. There is danger of injury to children from tools, disassembled products, etc.
 UNPLUG	<ul style="list-style-type: none"> Always disconnect the power plug before starting work whenever power is not required. Failure to disconnect the power plug before starting work can result in electrical shock.
 SHOCK HAZARD	<ul style="list-style-type: none"> Depending on the model, use an insulation transformer or wear gloves when servicing with the power on, and disconnect the power plug to avoid electrical shock when replacing parts. In some cases, alternating current is also impressed in the chassis, so electrical shock is possible if the chassis is contacted with the power on.
 USE SPECIFIED PARTS	<ul style="list-style-type: none"> Always use the replacement parts specified for the particular model when making repairs. The parts used in products have the necessary safety characteristics such as inflammability, voltage resistance, etc.; therefore, use only replacement parts that have these same characteristics. Use only the specified parts when the  mark is included in a circuit diagram or parts list.
 CAUTION FOR WIRING	<ul style="list-style-type: none"> Parts mounting and routing of the wiring should be the same as that used originally. For safety purposes, insulating materials such as tubing or tape is sometimes used and potted circuit boards are sometimes mounted floating. Also make sure that wiring is routed and clamped to avoid parts that generate heat and which use high voltage. Always follow the original scheme.
 CAUTION FOR ASSEMBLING / WIRING	<ul style="list-style-type: none"> After a repair has been completed, reassemble all disassembled parts, and route and reconnect the wiring, in accordance with the original scheme. Do not allow internal wiring to be pinched by cabinets, panels, etc. Any error in reassembly or wiring can result in electrical leakage, flame, etc., and may be hazardous.
 CHECK INSULATION RESISTANCE	<ul style="list-style-type: none"> After completing the work, disconnect the power plug from the outlet, remove the antenna, turn on the power switch. Then, use a 500V insulation resistance meter to check the insulation resistance of the antenna terminal, other metallic parts and between the prongs of the power plug to make sure that the insulation resistance is 1M Ω or more. The set will require inspection and repair if the insulation resistance is below this value.
 PROHIBIT REMODELING	<ul style="list-style-type: none"> Never remodel the product in any way. Remodeling can result in improper operation, malfunction, or electrical leakage and flame, which may be hazardous.

HANDLING THE LCD MODULE

Safety Precautions

In the event that the screen is damaged or the liquid crystal (fluid) leaks, do not breathe in or drink this fluid. Also, never touch this fluid.

Such actions could cause toxicity or skin irritation. If this fluid should enter the mouth, rinse the mouth thoroughly with water. If the fluid should contact the skin or clothing, wipe off with alcohol, etc., and rinse thoroughly with water. If the fluid should enter the eyes, immediately rinse the eyes thoroughly with running water.

Precautions for Handling the LCD Module

The LCD module can easily be damaged during disassembly or reassembly; therefore, always observe the following precautions when handling the module.

1. When attaching the LCD module to the LCD cover, position it appropriately and fasten at the position where the display can be viewed most conveniently.

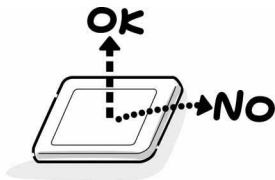

2. Carefully align the holes at all four corners of the LCD module with the corresponding holes in the LCD cover and fasten with screws. Do not strongly push on the module because any impact can adversely affect the performance. Also use caution when handling the polarized screen because it can easily be damaged.

CAUTION

The metal edges of the LCD module are sharp, so use caution to avoid injury.

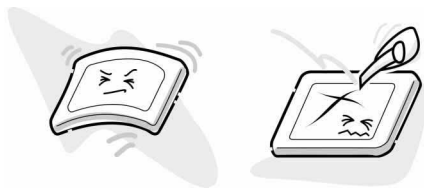

3. If the panel surface becomes soiled, wipe with cotton or a soft cloth. If this does not remove the soiling, breathe on the surface and then wipe again.

If the panel surface is extremely soiled, use a CRT cleaner as a cleaner. Wipe off the panel surface by drop the cleaner on the cloth. Do not drop the cleaner on the panel. Pay attention not to scratch the panel surface.



4. Leaving water or other fluids on the panel screen for an extended period of time can result in discoloration or stripes. Immediately remove any type of fluid from the screen.



5. Glass is used in the panel, so do not drop or strike with hard objects. Such actions can damage the panel.



6. CMOS-LSI circuitry is used in the LCD module, so avoid damage due to static electricity. When handling the module, use a wrist ground or anchor ground.

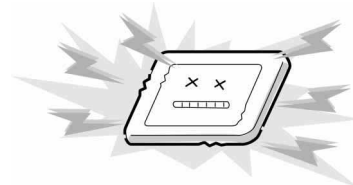

7. Do not expose the LCD module to direct sunlight or strong ultraviolet rays for an extended period of time.

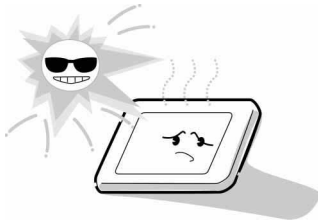

8. Do not store the LCD module below the temperature conditions described in the specifications. Failure to do so could result in freezing of the liquid crystal due to cold air or loss of resilience or other damage.

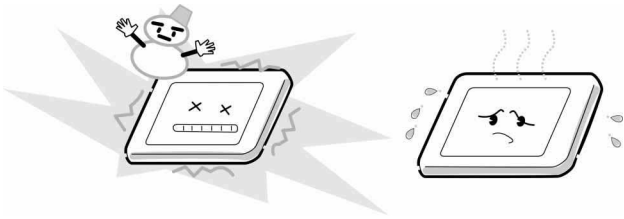

9. Do not disassemble the LCD module. Such actions could result in improper operation.

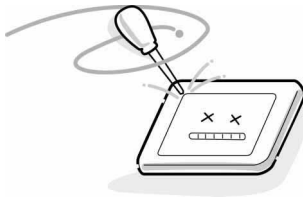

10. When transporting the LCD module, do not use packing containing epoxy resin (amine) or silicon resin (alcohol or oxim). The gas generated by these materials can cause loss of polarity.

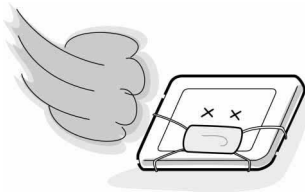

SERVICE MODE

1. ENTERING SERVICE MODE

- 1) Press MUTE button once on Remote Control.
- 2) Press MUTE button again and keep pressing.
- 3) While pressing the MUTE button, press MENU button on TV set.



2. DISPLAYING THE ADJUSTMENT MENU

- 1) Press MENU button on TV.

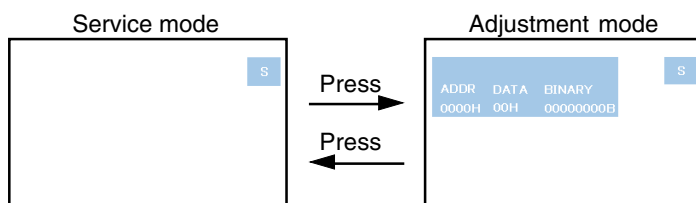

3. KEY FUNCTION IN THE SERVICE MODE

The following key entry during display of adjustment menu provides special functions.

Test signal selection :	MUTE button (on Remote)
Selection of the adjustment items :	Channel $\blacktriangle/\blacktriangledown$ (on TV or Remote)
Change of the data value :	Volume $\blacktriangle/\blacktriangledown$ +/- (on TV or Remote)
Adjustment menu mode ON/OFF :	MENU button (on TV)
Initialization of the memory :	CALL + Channel button on TV (\blacktriangle)
Reset the count of operating protect circuit to "00":	CALL + Channel button on TV (\blacktriangledown)
"RCUT" selection :	1 button
"GCUT" selection :	2 button
"BCUT" selection :	3 button
"SCNT" selection :	4 button
"COLP" selection :	5 button
"TNTC" selection :	6 button
Automatic A/D Adjustment(PC, Component):	7 button
Self diagnostic display ON/OFF :	9 button

- - - - Color thickness correction
note: Displayed differently as shown below, depending on the setting of the receiving color system.
COLP (PAL)
COLC (NTSC)
COLS (SECAM)

CAUTION : Never try to perform initialization unless you have changed the memory IC.

4. SELECTING THE ADJUSTING ITEMS

- 1) Every pressing of CHANNEL ▲ button in the service mode changes the adjustment items in the order of table-2.
(▼ button for reverse order)

5. ADJUSTING THE DATA

- 1) Pressing of VOLUME ▲ +/- button will change the value of data in the range from 00H to FFH. The variable range depends on the adjusting item.

6. EXIT FROM SERVICE MODE

- 1) Pressing POWER button to turn off the TV once.

■ INITIALIZATION OF MEMORY DATA

After replacing EEPROM IC, the following initialization is required.

1. Enter the service mode, then select any register item.
2. Press and hold the CALL button on the Remote, then press the CHANNEL▲ button on the TV. The initialization of EEPROM IC has been completed.
3. Check the picture carefully. If necessary, adjust any adjustment item above.
Perform "Auto tune" on the owner's manual.

CAUTION: Never attempt to initialize the data unless EEPROM IC has been replaced.

7. TEST SIGNAL SELECTION

- 1) Every pressing of -⊖ button on the Remote Control changes the built-in test patterns on screen as described below in SERVICE MODE.

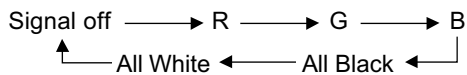

Signals	Picture
<ul style="list-style-type: none">• Red raster• Green raster• Blue raster• All Black• All White	

8. SELF DIAGNOSTIC FUNCTION

- 1) Press "9" button on Remote Control during display of adjustment menu in the service mode.
The diagnosis will begin to check if interface among IC's is executed properly.
- 2) During diagnosis, the following displays are shown.



- ① Firmware :
Version information of microprocessor
In case of file name : WL55_ASIA and Version : 0100 indicates [WL55_ASIA_0100].
- ② Time : Total hour of turn the TV on. (Unit : H)
- ③ Power : Operation number of protecting circuit ----"000" is normal.
When indication is other than "000", overcurrent apt to flow, and circuit parts may possibly be damaged.
- ④ Bus line : --"OK" is normal
"SCL-GND"(Red indication) : SCL-GND short circuit
"SDA-GND"(Red indication) : SDA-GND short circuit
"SCL-SDA"(Red indication) : SCL-SDA short circuit
- ⑤ Bus cont : --- "OK" is normal.
NG is abnormal(Red indication), when
type name of semiconductor indicates.
- ⑥ Block
UV: TV reception mode
V1 : VIDEO 1 input mode (→ 1)
V2 : VIDEO 2 input mode (→ 2)
V3 : VIDEO 3 input mode (→ 3)
- ⑦ 8 digit : CD number
- ⑧ Model name (7 digit)

9. VERSION CHECK MODE

- 1) Press “9” button twice on Remote Control during display of adjustment menu in the service mode. The version of main MPU will begin to check.
- 2) During Version Check, the following displays are shown.

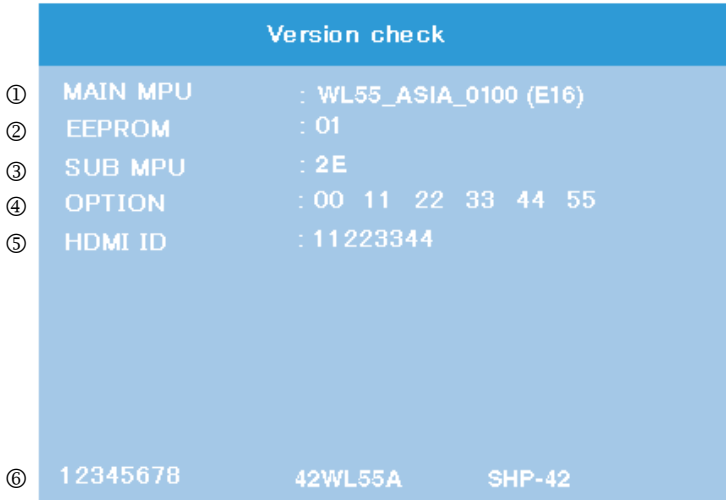

⑦ ⑧

- ① MAIN MPU :
Version information of microprocessor
In case of file name : WL55_ASIA, Version 0100 for Code Program Version and (E16) for OSD Version indicates [WL55_ASIA_0100(E16)]
- ② EEPROM :
Version information of EEPROM : Display 1 byte data.
- ③ SUB MPU :
Version information of SUB MPU : Display 1 byte data.
- ④ OPTION :
Option information : Display six numbers of 1 byte data.
- ⑤ HDMI ID :
HDMI ID information : Display 4 byte data.
- ⑥ CD number : Display 8 digit number
- ⑦ Model name : Display 7 digit number
- ⑧ Panel Vender information display
The following Panel Vender and screen size are displayed.

Panel	Panel Vender	Screen Size(Inch)
LCD	LPL	-23
	SHP	-26
	CMO	-32
		-37
		-42
PDP	LG	-42

Example : SHP-42 indicates that Vender is SHP and Screen Size is 42 inch.

10. STATUS CHECK MODE

- 1) Press "9" button thrice on Remote Control during display of adjustment menu in the service mode. The status of this model will begin to check.
- 2) During Status Check, the following displays are shown.

Status check	
①	MAIN : EXT1
②	MAIN FORMAT : 1080i-50
③	MAIN PLL : C6 38 54 CE 08
④	SCREEN SIZE : Super live
⑤	OTHER STATUS : 0000 0000 0000

- ① MAIN :
Main source information :
Display RF position number (0 - 99) on the main screen, or Input Source (EXT1/2/3/HDMI etc.)
- ② MAIN FORMAT :
Display Video and PC format information
- ③ MAIN PLL :
Main PLL information : Display five numbers of 1 byte data.
- ④ SCREEN SIZE :
Display the screen size as follows.

Super live
Cinema
Subtitle
14:9
Wide
4:3

- ⑤ OTHER STATUS :
Other status information : Display three numbers of 2 byte data.

LOCATION OF CONTROLS

TOP/Front

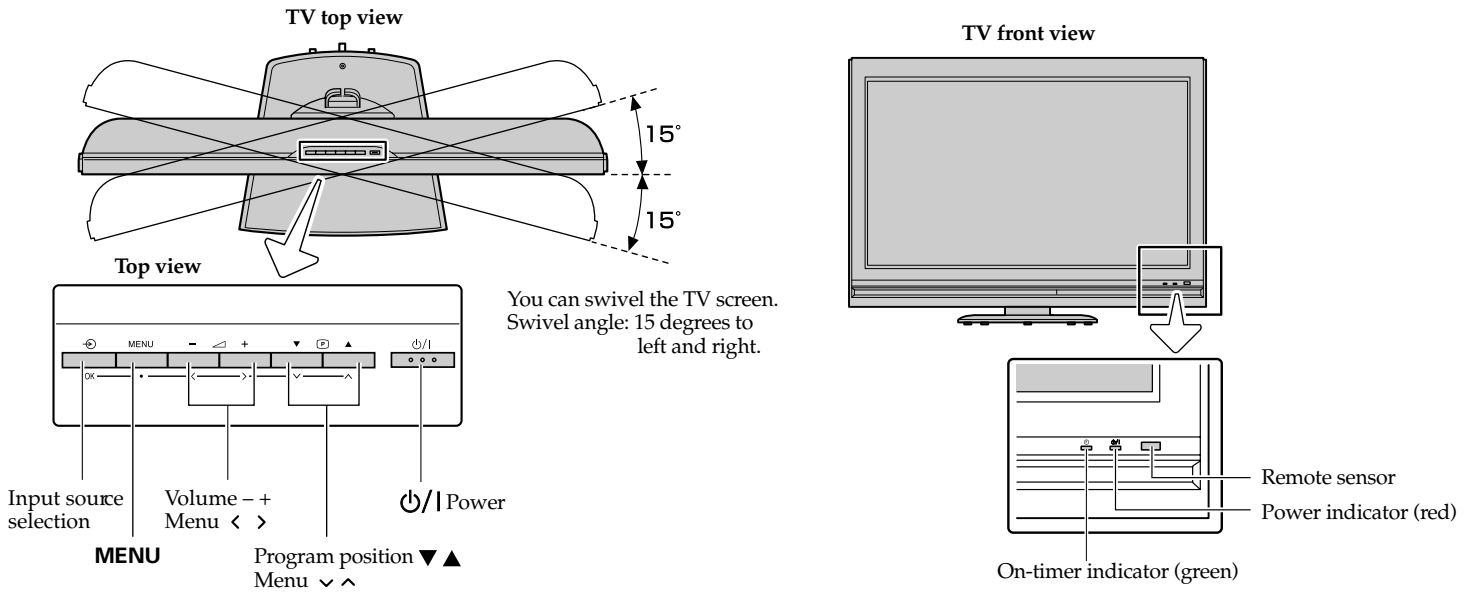

Back

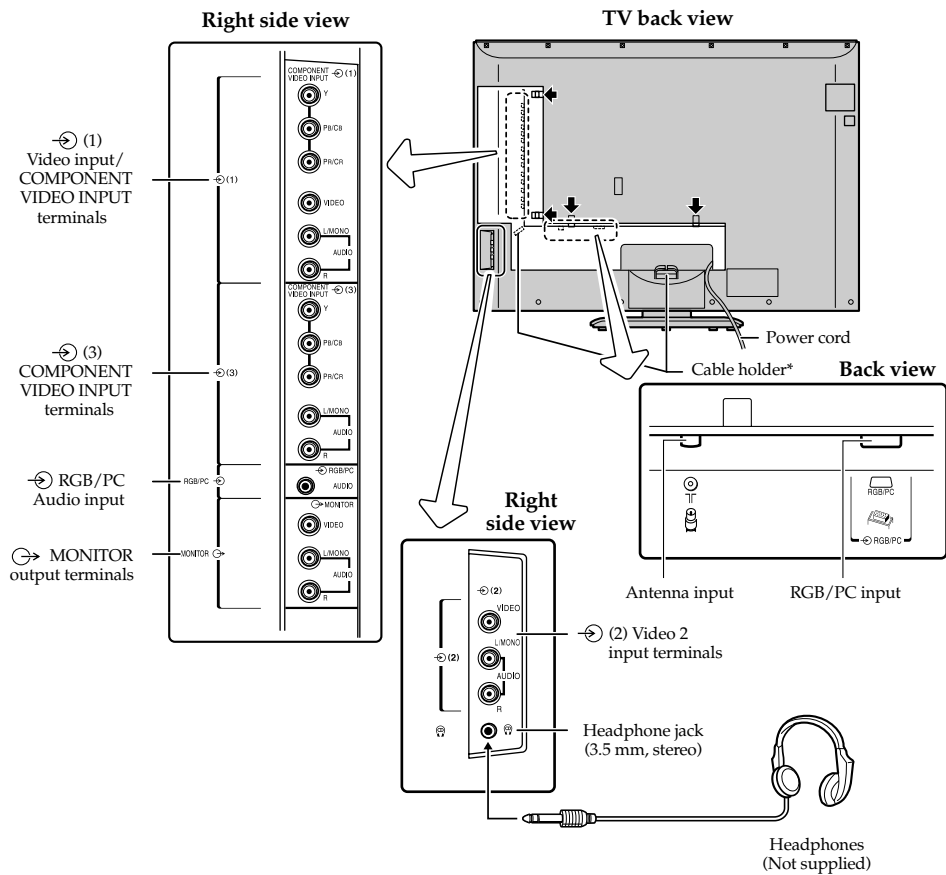

Remote control

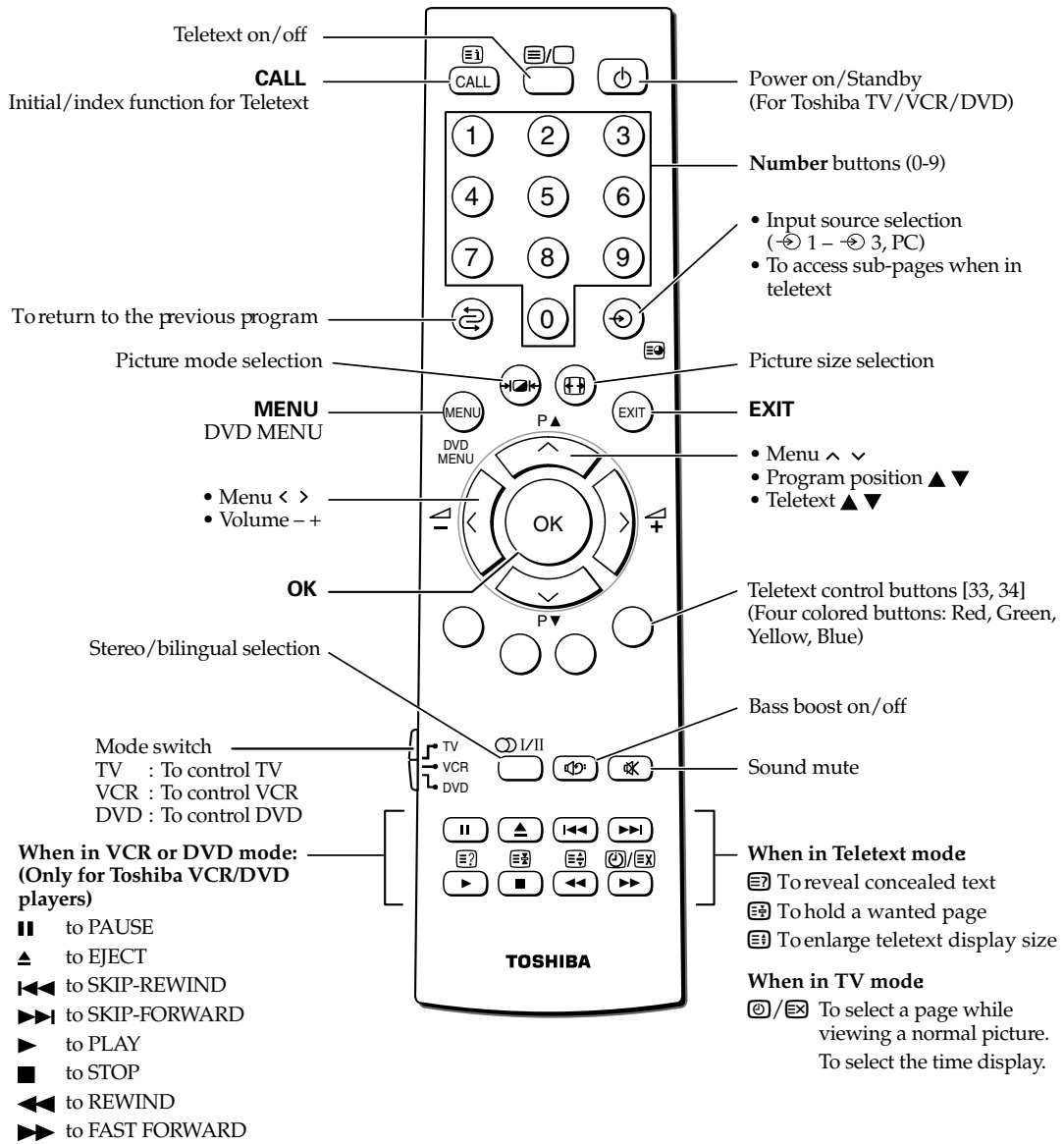

LAYOUT OF MAJOR BOARDS

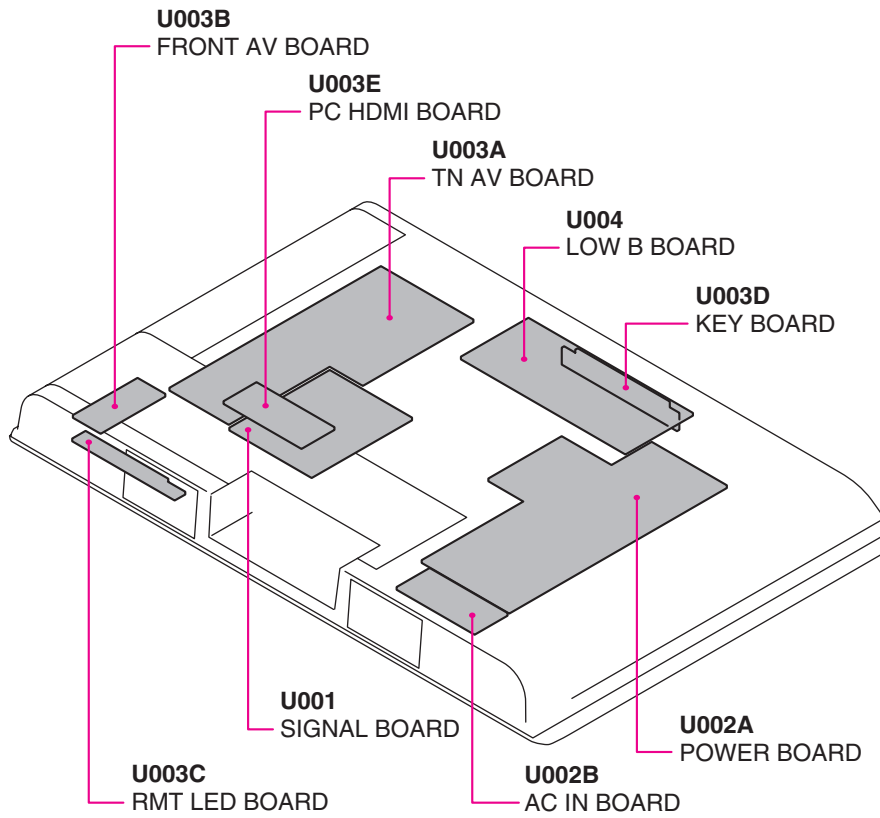

MECHANICAL DISASSEMBLY

1. Remove the stand (foot) and back cover.

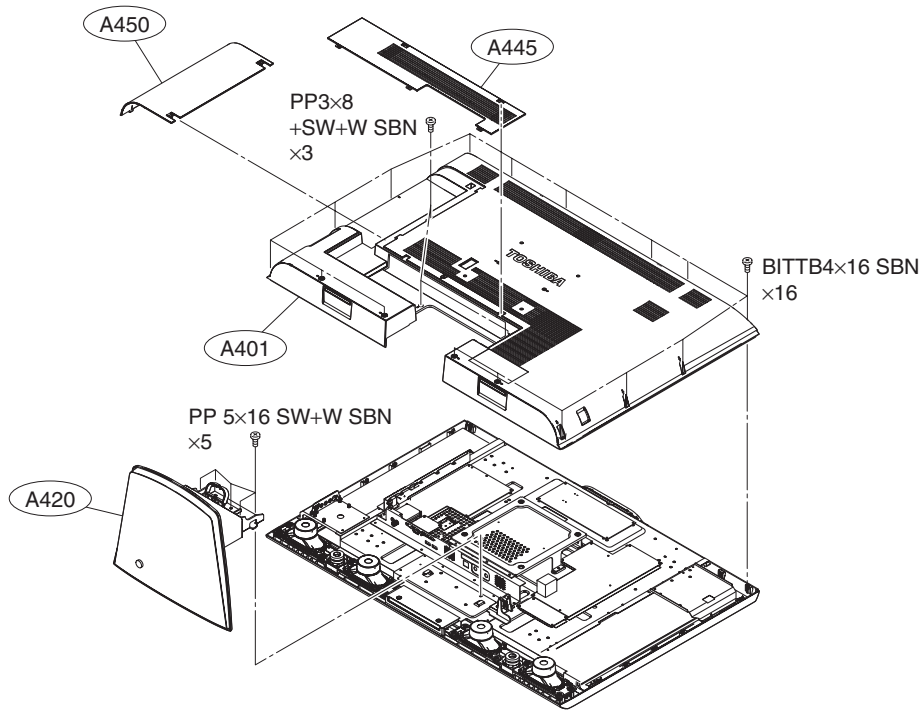

2. Remove the boards (FRONT AV,PC HDMI, KEY) and back center cover.

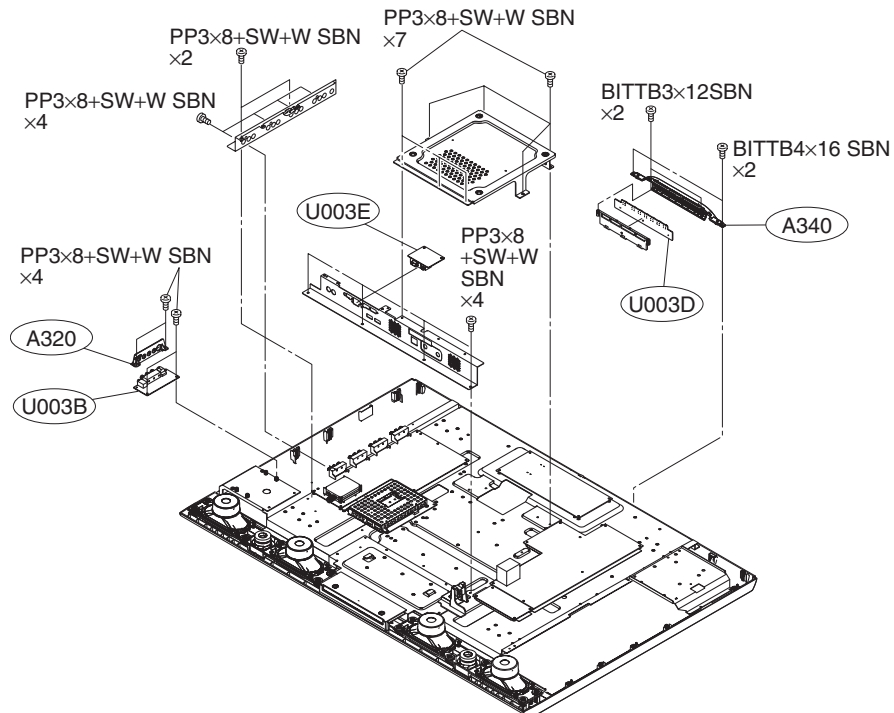

3. Remove the boards (POWER, AC-IN, SIGNAL, LOW B, TN AV, RMT LED) and speaker.

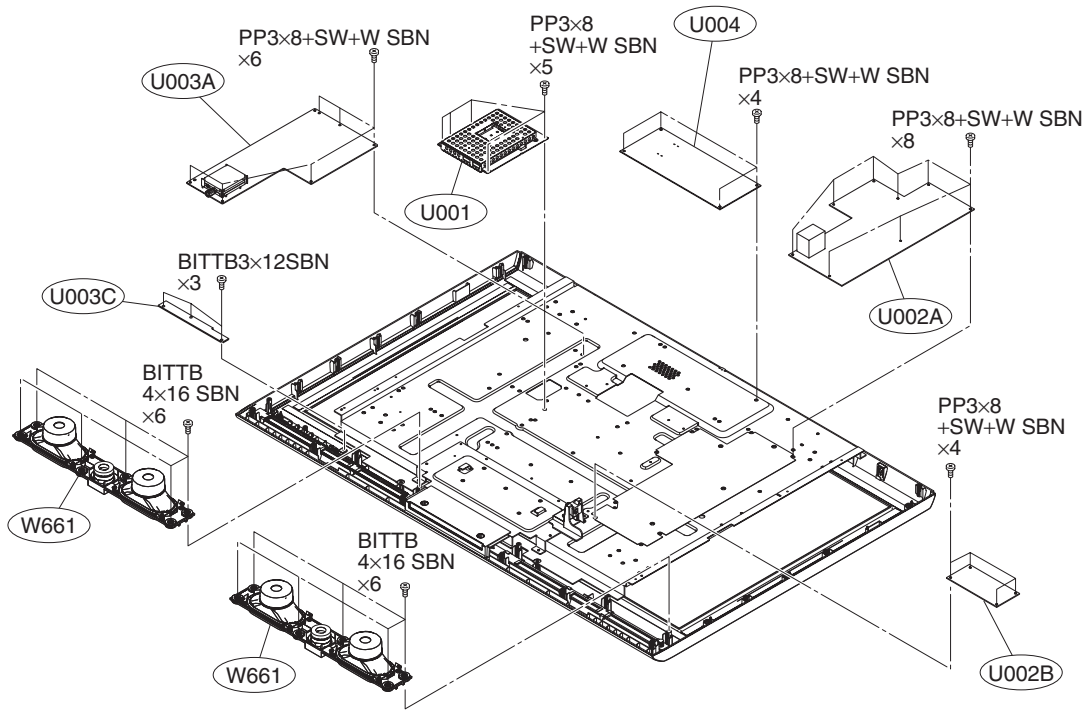

4. Remove the display.

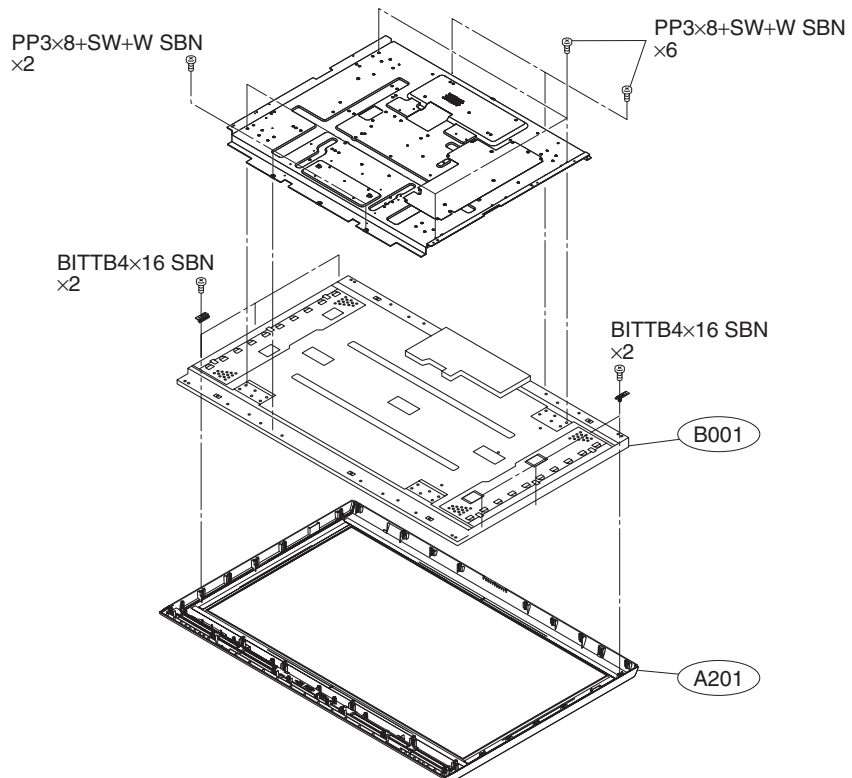

EXPLODED VIEWS

1. Chassis Block

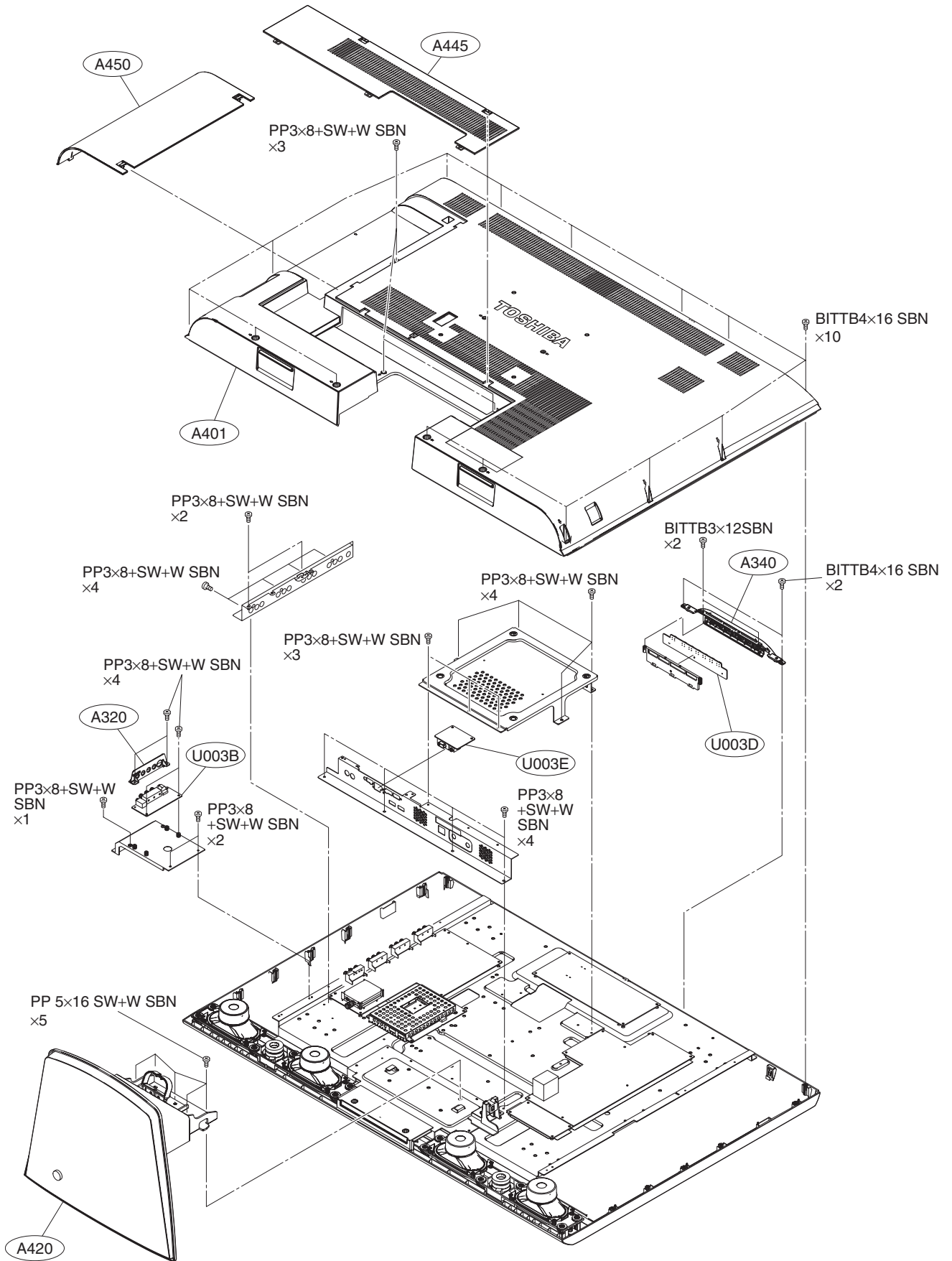

2. Main Block

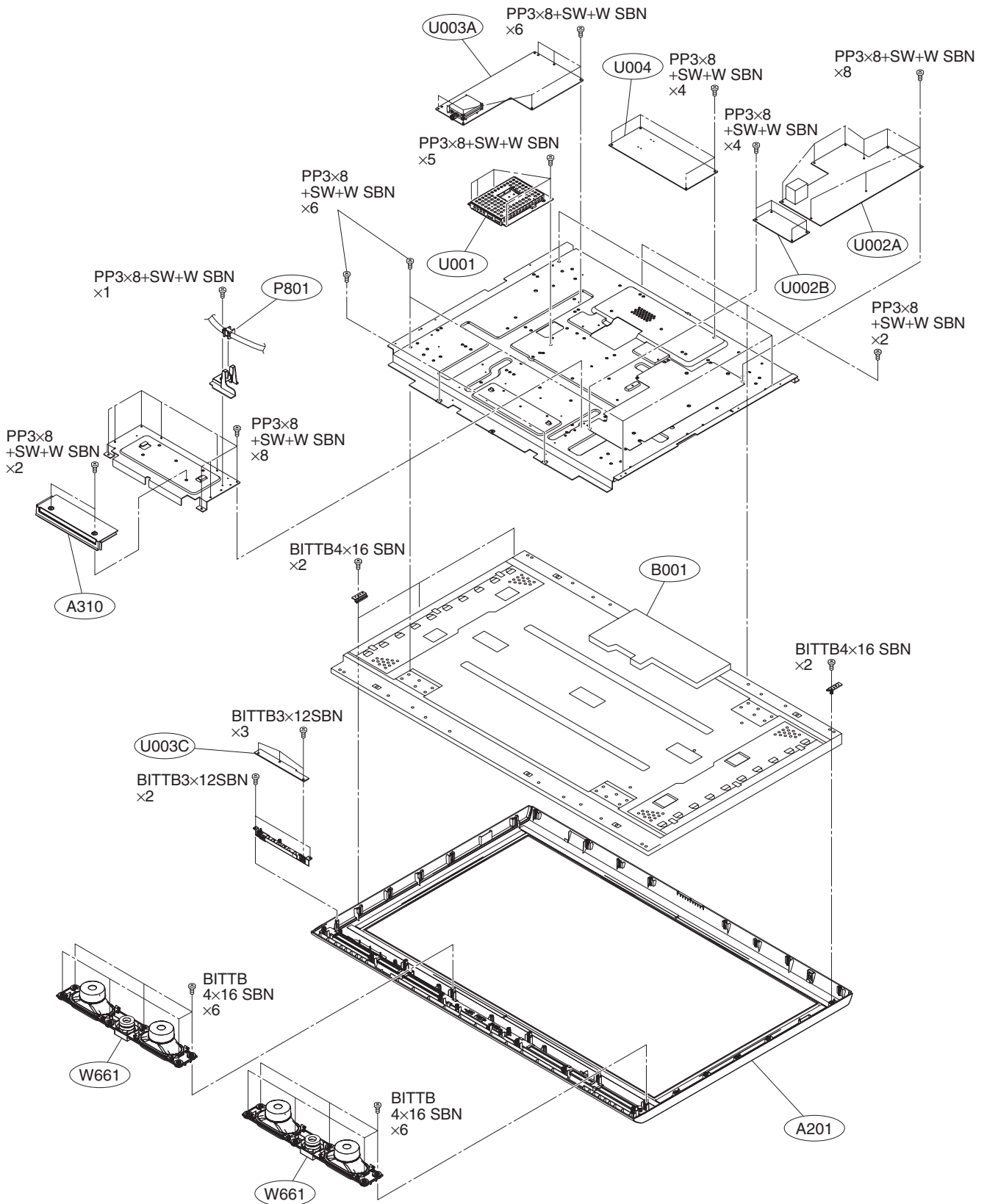

PACKING DISASSEMBLY

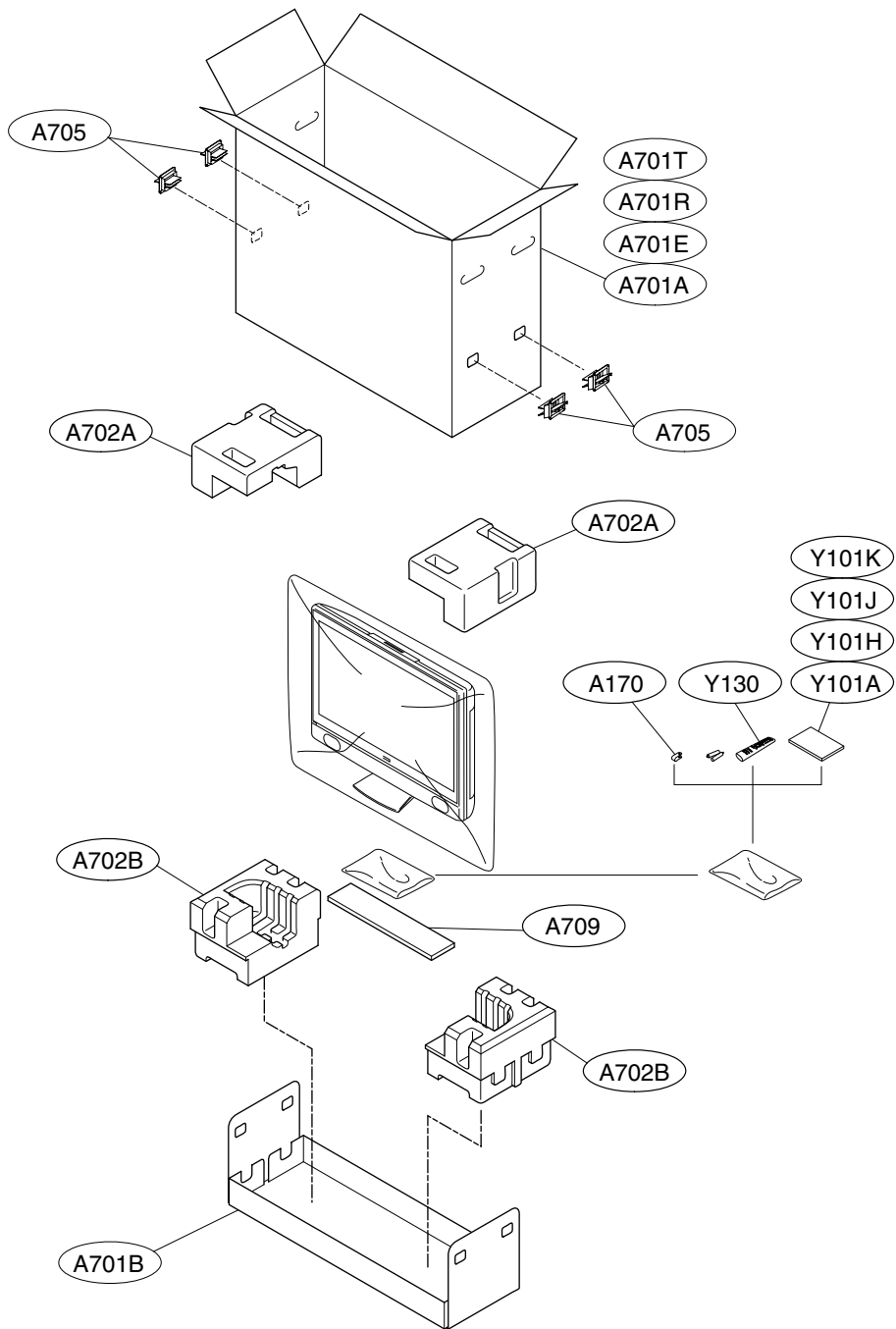

CHASSIS AND CABINET REPLACEMENT PARTS LIST

WARNING: BEFORE SERVICING THIS CHASSIS, READ THE "SERVICE SAFETY PRECAUTIONS" ON PAGE 3 OF THIS MANUAL.

CAUTION: The international hazard symbols " " in the schematic diagram and the parts list designate components which have special characteristics important for safety and should be replaced only with types identical to those in the original circuit or specified in the parts list. The mounting position of replacements is to be identical with originals. Before replacing any of these components, read carefully the PRODUCT SAFETY NOTICE. Do not degrade the safety of the receiver through improper servicing.

NOTICE:
The part number must be used when ordering parts, in order to assist in processing, be sure to include the Model number and Description.
The PC board assembly with* mark is no longer available after the end of the production.

Model : 42WL55A/42WL55E/42WL55R/42WL55T

Capacitors CD : Ceramic Disk PF : Plastic Film EL : Electrolytic
Resistors CF : Carbon Film CC : Carbon Composition MF : Metal Film
 OMF : Oxide Metal Film VR : Variable Resistor FR : Fusible Resistor
(All CD and PF capacitors are $\pm 5\%$, 50V and all resistors, $\pm 5\%$, 1/6W unless otherwise noted.)

Location No.	Parts No.	Description
#1 :	[42WL55A]	
#2 :	[42WL55E]	
#3 :	[42WL55R]	
#4 :	[42WL55T]	
CAPACITORS		
C101	76109103	CERAMIC CHIP, 50V B 0.01UF K
C102	76073039	ELECTROLYTIC, 16V 220UF M 3A
C103	76109102	CERAMIC CHIP, 50V B 1000PF K
C104	76619143	ELECTROLYTIC CHIP, 50V 4.7UF M
C105	76073039	ELECTROLYTIC, 16V 220UF M 3A
C110	76109102	CERAMIC CHIP, 50V B 1000PF K
C111	76109102	CERAMIC CHIP, 50V B 1000PF K
C114	76105101	CERAMIC CHIP, 50V CH 100PF J
C115	76105101	CERAMIC CHIP, 50V CH 100PF J
C117	76109103	CERAMIC CHIP, 50V B 0.01UF K
C118	76109103	CERAMIC CHIP, 50V B 0.01UF K
C162	76105101	CERAMIC CHIP, 50V CH 100PF J
C164	76100103	CERAMIC CHIP, 50V F 0.01UF Z
C190	76092730	CERAMIC CHIP, 16V B 0.1UF K
C501	76100104	CERAMIC CHIP, 25V F 0.1UF Z
C502	76100104	CERAMIC CHIP, 25V F 0.1UF Z
C503	76619046	ELECTROLYTIC CHIP, 16V 470UF
C504	76109103	CERAMIC CHIP, 50V B 0.01UF K
C505	76619046	ELECTROLYTIC CHIP, 16V 470UF
C506	76109103	CERAMIC CHIP, 50V B 0.01UF K
C514	76665221	ELECTROLYTIC, 10V 220UF M 3A
C516	76105110	CERAMIC CHIP, 50V CH 11PF J
C517	76092785	CERAMIC CHIP, 10V B 0.47UF K
C519	76619048	ELECTROLYTIC CHIP, 25V 4.7UF M
C521	76092733	CERAMIC CHIP, 50V B 0.022UF K
C524	76109103	CERAMIC CHIP, 50V B 0.01UF K
C526	76109103	CERAMIC CHIP, 50V B 0.01UF K
C527	76619071	ELECTROLYTIC CHIP, 50V 2.2UF
C529	76100104	CERAMIC CHIP, 25V F 0.1UF Z
C530	76619157	ELECTROLYTIC CHIP, 16V 100UF
C605	76109102	CERAMIC CHIP, 50V B 1000PF K
C606	76109102	CERAMIC CHIP, 50V B 1000PF K
C660	76669479	ELECTROLYTIC, 50V 4.7UF M
C661	76669479	ELECTROLYTIC, 50V 4.7UF M
C662	76109681	CERAMIC CHIP, 50V B 680PF K
C663	76109681	CERAMIC CHIP, 50V B 680PF K
C668	76619100	ELECTROLYTIC CHIP, 16V 10UF M
C670	76669100	ELECTROLYTIC, 50V 10UF M
C671	76669100	ELECTROLYTIC, 50V 10UF M
C673	76619102	ELECTROLYTIC CHIP, 16V 47UF M

Location No.	Parts No.	Description
C674	76092731	CERAMIC CHIP, 16V B 1UF K
C677	76619141	ELECTROLYTIC CHIP, 50V 2.2UF M
C678	76285104	CERAMIC CHIP, 50V B 0.1UF K
C679	76285104	CERAMIC CHIP, 50V B 0.1UF K
C680	76668102	ELECTROLYTIC, 35V 1000UF M 3A
C681	76668102	ELECTROLYTIC, 35V 1000UF M 3A
C682	76668102	ELECTROLYTIC, 35V 1000UF M 3A
C684	76109103	CERAMIC CHIP, 50V B 0.01UF K
C685	76109103	CERAMIC CHIP, 50V B 0.01UF K
C690	76664102	ELECTROLYTIC, 6.3V 1000UF M 3A
C691	76092463	CERAMIC CHIP, 16V B 0.22UF K
C692	76092463	CERAMIC CHIP, 16V B 0.22UF K
△ C801	76168007	MT PLA AC275V 1UF M
△ C802	76503508	MT PLA PCX2 337 11474
△ C806	76092555	CERAMIC DISC, AC250V E 1000PF M
△ C807	76092555	CERAMIC DISC, AC250V E 1000PF M
△ C808	76092553	CERAMIC DISC, AC250V B 470PF K
△ C809	76092553	CERAMIC DISC, AC250V B 470PF K
C812	76109102	CERAMIC CHIP, 50V B 1000PF K
C814	76109102	CERAMIC CHIP, 50V B 1000PF K
C815	76073037	ELECTROLYTIC, 16V 47UF M 3A
C816	76109102	CERAMIC CHIP, 50V B 1000PF K
C817	76109102	CERAMIC CHIP, 50V B 1000PF K
C818	76669010	ELECTROLYTIC, 50V 1UF M
C819	76539684	PLASTIC FILM, 50V 0.68UF J
C820	76125010	CHEMICON CE69R 450V 270UF M 3H
C821	76125011	CHEMICON CE04R 450V 82UF M 4A
C822	76214103	CERAMIC DISC, 500V B 0.01UF K
C824	76168008	MT PLA 450V 1UF K
C825	76168008	MT PLA 450V 1UF K
C826	76092339	CERAMIC DISC, 2KV 330PF K
C827	76092339	CERAMIC DISC, 2KV 330PF K
C840	76125009	CHEMICON 450V 47UF M
C843	76166001	CERAMIC DISK CC45 SL 3.15KV 47PF J
C844	76669479	ELECTROLYTIC, 50V 4.7UF M
C845	76073196	ELECTROLYTIC, 50V 22UF M 3A
C846	76073140	ELECTROLYTIC CE04P 10V 680UF M 3A
C847	76665471	ELECTROLYTIC, 10V 470UF M
C848	76214471	CERAMIC DISC, 500V B 470PF K
C860	76214103	CERAMIC DISC, 500V B 0.01UF K
C861	76503053	PLASTIC FILM, 63V 1UF J
C862	76669229	ELECTROLYTIC, 50V 2.2UF M
C863	76503049	PLASTIC FILM, 63V 0.47UF J
C864	76567224	PLASTIC FILM, 50V 0.22UF J
C865	76567224	PLASTIC FILM, 50V 0.22UF J
C866	76092341	CERAMIC DISC, 2KV R 470PF K

Location No.	Parts No.	Description
C868	76435221	CERAMIC DISC, 500V SL 220PF J
C869	76435221	CERAMIC DISC, 500V SL 220PF J
△ C870	76503425	PLASTIC FILM CQ92 3D2J473J-K5
C872	76073189	ELECTROLYTIC, 35V 1000UF M
C873	76073189	ELECTROLYTIC, 35V 1000UF M
C876	76073204	ELECTROLYTIC CE04P 50V 330UF M 3A
C877	76669229	ELECTROLYTIC, 50V 2.2UF M
C878	76503041	PLASTIC FILM, 63V 0.1UF J
C880	76503229	PLASTIC FILM, 1250VH 1000PF H
C881	76092337	CERAMIC DISC, 2KV 220PF K
C882	76567334	PLASTIC FILM, 50V 0.33UF J
C883	76212221	CERAMIC DISC, 50V B 220PF K
C884	76073196	ELECTROLYTIC, 50V 22UF M 3A
C885	76214471	CERAMIC DISC, 500V B 470PF K
C886	76212152	CERAMIC DISC, 50V B 1500PF K
C887	76214471	CERAMIC DISC, 500V B 470PF K
C888	76073189	ELECTROLYTIC, 35V 1000UF M
C889	76073189	ELECTROLYTIC, 35V 1000UF M
C890	76796102	ELECTROLYTIC, 35V 1000UF M
C891	76214471	CERAMIC DISC, 500V B 470PF K
C892	76676100	ELECTROLYTIC, 100V 10UF M 3A
C893	76747220	ELECTROLYTIC, 50V 22UF M 7L 3A
C894	76214471	CERAMIC DISC, 500V B 470PF K
C895	76073188	ELECTROLYTIC, 35V 680UF M
C896	76073188	ELECTROLYTIC, 35V 680UF M
C897	76796102	ELECTROLYTIC, 35V 1000UF M
C898	76669010	ELECTROLYTIC, 50V 1UF M
C8171	76092730	CERAMIC CHIP, 16V B 0.1UF K
C8191	76092730	CERAMIC CHIP, 16V B 0.1UF K
C8210	76105331	CERAMIC CHIP, 50V CH 330PF J
C8211	76815473	CERAMIC CHIP, 50V B 0.047UF K
C8212	76092178	CERAMIC CHIP, 25V B 0.1UF K
C8213	76109102	CERAMIC CHIP, 50V B 1000PF K
C8241	76073196	ELECTROLYTIC, 50V 22UF M 3A
C8250	76092341	CERAMIC DISC, 2KV R 470PF K
C8251	76434100	CERAMIC DISC, 500V SL 10PF D
C8390	76109102	CERAMIC CHIP, 50V B 1000PF K
C8401	76092733	CERAMIC CHIP, 50V B 0.022UF K
C8402	76092733	CERAMIC CHIP, 50V B 0.022UF K
C8403	76669470	ELECTROLYTIC, 50V 47UF M
C8490	76669010	ELECTROLYTIC, 50V 1UF M
C8601	76591682	PLASTIC FILM, 50V 6800PF J
C8602	76212101	CERAMIC DISC, 50V B 100PF K
C8605	76285104	CERAMIC CHIP, 50V B 0.1UF K
C8701	76567224	PLASTIC FILM, 50V 0.22UF J
C8702	76287224	CHIP CER 50V F 224Z GRM319F11H224ZA01D
C8703	76109102	CERAMIC CHIP, 50V B 1000PF K
C8801	76092730	CERAMIC CHIP, 16V B 0.1UF K
C8802	76092883	CERAMIC CHIP, 50V B 0.1UF K
C8891	76503049	PLASTIC FILM, 63V 0.47UF J
CB01	76202221	ELECTROLYTIC, 10V 220UF M 7L 3A
CB02	76202221	ELECTROLYTIC, 10V 220UF M 7L 3A
CB03	76100104	CERAMIC CHIP, 25V F 0.1UF Z
CB04	76100104	CERAMIC CHIP, 25V F 0.1UF Z
CB05	76202221	ELECTROLYTIC, 10V 220UF M 7L 3A
CB38	76100104	CERAMIC CHIP, 25V F 0.1UF Z
CC01	76109102	CERAMIC CHIP, 50V B 1000PF K
CC02	76109102	CERAMIC CHIP, 50V B 1000PF K
CC03	76109102	CERAMIC CHIP, 50V B 1000PF K
CC05	76109102	CERAMIC CHIP, 50V B 1000PF K
CC06	76109102	CERAMIC CHIP, 50V B 1000PF K
CC07	76109102	CERAMIC CHIP, 50V B 1000PF K
CC11	76109102	CERAMIC CHIP, 50V B 1000PF K
CC12	76109102	CERAMIC CHIP, 50V B 1000PF K
CC31	76109102	CERAMIC CHIP, 50V B 1000PF K
CC40	76109102	CERAMIC CHIP, 50V B 1000PF K
CC41	76109102	CERAMIC CHIP, 50V B 1000PF K
CE10	76666470	ELECTROLYTIC, 16V 47UF M 3A
CE11	76539474	PLASTIC FILM, 50V 0.47UF J
CE12	76666470	ELECTROLYTIC, 16V 47UF M 3A
CE60	76073186	ELECTROLYTIC, 35V 470UF M
CE61	76617028	ELECTROLYTIC, 16V 1200UF M
CE62	76073020	ELECTROLYTIC, 10V 1000UF M 3A
CE63	76539104	PLASTIC FILM, 50V 0.1UF J
CE64	76539104	PLASTIC FILM, 50V 0.1UF J
CE65	76666470	ELECTROLYTIC, 16V 47UF M 3A

Location No.	Parts No.	Description
CE66	76539474	PLASTIC FILM, 50V 0.47UF J
CE67	76666470	ELECTROLYTIC, 16V 47UF M 3A
CE90	76073186	ELECTROLYTIC, 35V 470UF M
CE91	76617028	ELECTROLYTIC, 16V 1200UF M
CE92	76666471	ELECTROLYTIC, 16V 470UF M
CE93	76539104	PLASTIC FILM, 50V 0.1UF J
CE94	76539104	PLASTIC FILM, 50V 0.1UF J
CE95	76668101	ELECTROLYTIC, 35V 100UF M 3A
CT01	76092790	CERAMIC CHIP CK732B 6.3V 10UF K
CT04	76105820	CERAMIC CHIP, 50V CH 82PF J
CT05	76092731	CERAMIC CHIP, 16V B 1UF K
CT06	76092790	CERAMIC CHIP CK732B 6.3V 10UF K
CT07	76092790	CERAMIC CHIP CK732B 6.3V 10UF K
CT10	76105151	CERAMIC CHIP, 50V CH 150PF J
CT11	76092731	CERAMIC CHIP, 16V B 1UF K
CT12	76092790	CERAMIC CHIP CK732B 6.3V 10UF K
CT13	76092790	CERAMIC CHIP CK732B 6.3V 10UF K
CT16	76105151	CERAMIC CHIP, 50V CH 150PF J
CT17	76092731	CERAMIC CHIP, 16V B 1UF K
CT18	76092790	CERAMIC CHIP CK732B 6.3V 10UF K
CT19	76092790	CERAMIC CHIP CK732B 6.3V 10UF K
CT20	76092789	CERAMIC CHIP, 6.3V B 1UF K
CV01	76100104	CERAMIC CHIP, 25V F 0.1UF Z
CV02	76100104	CERAMIC CHIP, 25V F 0.1UF Z
CV03	76100104	CERAMIC CHIP, 25V F 0.1UF Z
CV04	76100104	CERAMIC CHIP, 25V F 0.1UF Z
CV05	76100104	CERAMIC CHIP, 25V F 0.1UF Z
CV06	76619157	ELECTROLYTIC CHIP, 16V 100UF
CV07	76619157	ELECTROLYTIC CHIP, 16V 100UF
CV13	76100104	CERAMIC CHIP, 25V F 0.1UF Z
CV17	76092731	CERAMIC CHIP, 16V B 1UF K
CV18	76619157	ELECTROLYTIC CHIP, 16V 100UF
CV19	76619157	ELECTROLYTIC CHIP, 16V 100UF
CV20	76619101	ELECTROLYTIC CHIP, 16V 22UF M
CV51	76619100	ELECTROLYTIC CHIP, 16V 10UF M
CV52	76619100	ELECTROLYTIC CHIP, 16V 10UF M
CV53	76619100	ELECTROLYTIC CHIP, 16V 10UF M
CV54	76619100	ELECTROLYTIC CHIP, 16V 10UF M
CV122	76105101	CERAMIC CHIP, 50V CH 100PF J
CY650	76109103	CERAMIC CHIP, 50V B 0.01UF K
RESISTORS		
R101	76011101	CHIP, 1/20W 100 OHM J
R102	76011101	CHIP, 1/20W 100 OHM J
R103	76011101	CHIP, 1/20W 100 OHM J
R104	76011103	CHIP, 1/20W 10K OHM J
R105	76011273	CHIP, 1/20W 27K OHM J
R107	76000445	CHIP JUMPER, 1608TYPE
R108	76000445	CHIP JUMPER, 1608TYPE
R114	76000445	CHIP JUMPER, 1608TYPE
R167	76011101	CHIP, 1/20W 100 OHM J
R169	76000445	CHIP JUMPER, 1608TYPE
R170	76011682	CHIP, 1/20W 6.8K OHM J
R501	76011682	CHIP, 1/20W 6.8K OHM J
R502	76011272	CHIP, 1/20W 2.7K OHM J
R504	76011101	CHIP, 1/20W 100 OHM J
R505	76011101	CHIP, 1/20W 100 OHM J
R506	76011273	CHIP, 1/20W 27K OHM J
R507	76011392	CHIP, 1/20W 3.9K OHM J
R508	76011682	CHIP, 1/20W 6.8K OHM J
R512	76011101	CHIP, 1/20W 100 OHM J
R514	76011102	CHIP, 1/20W 1K OHM J
R660	76011473	CHIP, 1/20W 47K OHM J
R662	76011103	CHIP, 1/20W 10K OHM J
R663	76011473	CHIP, 1/20W 47K OHM J
R670	76011472	CHIP, 1/20W 4.7K OHM J
R671	76011472	CHIP, 1/20W 4.7K OHM J
R672	76011182	CHIP, 1/20W 1.8K OHM J
R673	76011182	CHIP, 1/20W 1.8K OHM J
R678	76871229	CHIP, 1/8W 2.2 OHM J
R679	76871229	CHIP, 1/8W 2.2 OHM J
R680	76011473	CHIP, 1/20W 47K OHM J
R681	76011473	CHIP, 1/20W 47K OHM J
R682	76011104	CHIP, 1/20W 100K OHM J
R683	76011103	CHIP, 1/20W 10K OHM J
R684	76011104	CHIP, 1/20W 100K OHM J

Location No.	Parts No.	Description
R685	76011222	CHIP, 1/20W 2.2K OHM J
R686	76011102	CHIP, 1/20W 1K OHM J
R687	76011102	CHIP, 1/20W 1K OHM J
R688	76871102	CHIP, 1/8W 1K OHM J
R689	76871102	CHIP, 1/8W 1K OHM J
R690	76011473	CHIP, 1/20W 47K OHM J
R691	76011103	CHIP, 1/20W 10K OHM J
R692	76011223	CHIP, 1/20W 22K OHM J
R693	76871102	CHIP, 1/8W 1K OHM J
R695	76871102	CHIP, 1/8W 1K OHM J
R696	76871102	CHIP, 1/8W 1K OHM J
R697	76871102	CHIP, 1/8W 1K OHM J
△ R801	76017004	METAL GLAZE 1/2W 510K J
△ R809	76004718	METAL GLAZE, 1/2W 8.2M OHM J
R812	76011473	CHIP, 1/20W 47K OHM J
R820	76019461	METAL PLATE, 2W 0.15 OHM J
R821	76019461	METAL PLATE, 2W 0.15 OHM J
R826	76004714	METAL GLAZE, 1/2W 1.2M OHM J
△ R830	76007061	CERAMIC COVERED, 2W 1.8 OHM K
R831	76120003	CERAMIC COVERED G 5W 4.7 J
R840	76382823	OXIDE FILM 1W 82K J
R841	76322339	METAL FILM 1W 3R3 J
R842	76310479	OXIDE METAL FILM, 1/2W 4.7 OHM J
R860	76552271	OXIDE METAL FILM, 1/2W 270 OHM J
R862	76552681	OXIDE METAL FILM, 1/2W 680 OHM J
R863	76011272	CHIP, 1/20W 2.7K OHM J
R864	76552101	OXIDE METAL FILM, 1/2W 100 OHM J
R865	76552100	OXIDE METAL FILM, 1/2W 10 OHM J
R867	76552330	OXIDE METAL FILM, 1/2W 33 OHM J
R880	76553683	OXIDE METAL FILM, 1W 68K OHM J
R881	76553683	OXIDE METAL FILM, 1W 68K OHM J
R882	76323569	METAL FILM 2W 5R6 J
R883	76079010	METAL RES 2W R47 J
R884	76321339	OXIDE METAL FILM, 1/2W 3.3 OHM J
R885	76553101	OXIDE METAL FILM, 1W 100 OHM J
R886	76554432	OXIDE FILM 2W 4.3K J
R4100	76011102	CHIP, 1/20W 1K OHM J
R4101	76011681	CHIP, 1/20W 680 OHM J
R4102	76011471	CHIP, 1/20W 470 OHM J
R4103	76011102	CHIP, 1/20W 1K OHM J
R4104	76011152	CHIP, 1/20W 1.5K OHM J
R4105	76011102	CHIP, 1/20W 1K OHM J
R4106	76011681	CHIP, 1/20W 680 OHM J
R4107	76011471	CHIP, 1/20W 470 OHM J
R4108	76011102	CHIP, 1/20W 1K OHM J
R4109	76011152	CHIP, 1/20W 1.5K OHM J
R4120	76000445	CHIP JUMPER, 1608TYPE
R4122	76000445	CHIP JUMPER, 1608TYPE
R6601	76011223	CHIP, 1/20W 22K OHM J
R6602	76011103	CHIP, 1/20W 10K OHM J
R6603	76011104	CHIP, 1/20W 100K OHM J
R6604	76011102	CHIP, 1/20W 1K OHM J
R6614	76011102	CHIP, 1/20W 1K OHM J
R6615	76011102	CHIP, 1/20W 1K OHM J
R6616	76011104	CHIP, 1/20W 100K OHM J
R6617	76011104	CHIP, 1/20W 100K OHM J
R8110	76000250	METAL FILM, 1/4W 56K OHM F
R8111	76000250	METAL FILM, 1/4W 56K OHM F
R8112	76000250	METAL FILM, 1/4W 56K OHM F
R8113	76000250	METAL FILM, 1/4W 56K OHM F
R8114	76000527	METAL FILM, 1/4W 5.6K OHM F
R8115	76000639	METAL FILM, 1/4W 22K OHM F
R8116	76000554	CHIP 1/16W 510 F
R8117	76000574	METAL FILM CHIP 1/16W 2.7K F
R8118	76000574	METAL FILM CHIP 1/16W 2.7K F
R8130	76871182	CHIP, 1/8W 1.8K OHM J
R8131	76871182	CHIP, 1/8W 1.8K OHM J
R8132	76871182	CHIP, 1/8W 1.8K OHM J
R8133	76011102	CHIP, 1/20W 1K OHM J
R8140	76011682	CHIP, 1/20W 6.8K OHM J
R8141	76011473	CHIP, 1/20W 47K OHM J
R8142	76872470	CHIP, 1/16W 47 OHM J
R8143	76872470	CHIP, 1/16W 47 OHM J
R8144	76872390	CHIP, 1/16W 39 OHM J
R8150	76011562	CHIP, 1/20W 5.6K OHM J
R8151	76011222	CHIP, 1/20W 2.2K OHM J

Location No.	Parts No.	Description
R8152	76011473	CHIP, 1/20W 47K OHM J
R8160	76011103	CHIP, 1/20W 10K OHM J
R8161	76011473	CHIP, 1/20W 47K OHM J
R8162	76011103	CHIP, 1/20W 10K OHM J
R8191	76000445	CHIP JUMPER, 1608TYPE
R8192	76011471	CHIP, 1/20W 470 OHM J
R8193	76011102	CHIP, 1/20W 1K OHM J
R8194	76011151	CHIP, 1/20W 150 OHM J
R8195	76011151	CHIP, 1/20W 150 OHM J
R8210	76998471	CHIP, 1/16W 470 OHM
R8212	76998102	CHIP, 1/16W 1K OHM
R8213	76011222	CHIP, 1/20W 2.2K OHM J
R8214	76000445	CHIP JUMPER, 1608TYPE
R8215	76998222	CHIP, 1/16W 2.2K OHM
R8216	76998222	CHIP, 1/16W 2.2K OHM
R8217	76011229	CHIP, 1/16W 2.2 OHM J
R8218	76998152	CHIP, 1/16W 1.5K OHM D
R8230	76872332	CHIP, 1/16W 3.3K OHM J
R8231	76011223	CHIP, 1/20W 22K OHM J
R8232	76011472	CHIP, 1/20W 4.7K OHM J
R8233	76011473	CHIP, 1/20W 47K OHM J
R8240	76190015	CHIP RES 1/16W 473D
R8241	76190015	CHIP RES 1/16W 473D
R8242	76190015	CHIP RES 1/16W 473D
R8243	76190015	CHIP RES 1/16W 473D
R8244	76190015	CHIP RES 1/16W 473D
R8245	76190015	CHIP RES 1/16W 473D
R8246	76190015	CHIP RES 1/16W 473D
R8247	76190015	CHIP RES 1/16W 473D
R8248	76190015	CHIP RES 1/16W 473D
R8249	76000445	CHIP JUMPER, 1608TYPE
R8310	76011223	CHIP, 1/20W 22K OHM J
R8312	76011471	CHIP, 1/20W 470 OHM J
R8313	76011102	CHIP, 1/20W 1K OHM J
R8390	76011473	CHIP, 1/20W 47K OHM J
R8391	76011102	CHIP, 1/20W 1K OHM J
R8392	76011681	CHIP, 1/20W 680 OHM J
R8393	76011681	CHIP, 1/20W 680 OHM J
R8394	76011681	CHIP, 1/20W 680 OHM J
R8395	76011681	CHIP, 1/20W 680 OHM J
R8396	76011222	CHIP, 1/20W 2.2K OHM J
R8403	76011102	CHIP, 1/20W 1K OHM J
R8404	76011101	CHIP, 1/20W 100 OHM J
R8405	76011102	CHIP, 1/20W 1K OHM J
R8406	76011473	CHIP, 1/20W 47K OHM J
R8407	76000572	CHIP 1/16W 3.3K F
R8408	76000422	CHIP 1/16W 2.2K F
R8409	76011102	CHIP, 1/20W 1K OHM J
R8410	76000445	CHIP JUMPER, 1608TYPE
R8411	76321479	OXIDE METAL FILM, 1/2W 4.7 OHM J
R8412	76871822	CHIP, 1/8W 8.2K OHM J
R8601	76000247	METAL FILM, 1/4W 39K OHM F
R8602	76366472	CARBON FILM, 1/6W 4.7K OHM J
R8603	76011103	CHIP, 1/20W 10K OHM J
R8604	76011102	CHIP, 1/20W 1K OHM J
R8605	76011472	CHIP, 1/20W 4.7K OHM J
R8606	76011103	CHIP, 1/20W 10K OHM J
R8607	76872221	CHIP, 1/16W 220 OHM J
R8701	76000595	CHIP 1/16W 15K F
R8702	76190012	METAL FILM CHIP 1/16W 1.5K F
R8703	76011221	CHIP, 1/20W 220 OHM J
R8704	76000445	CHIP JUMPER, 1608TYPE
R8705	76011220	CHIP, 1/20W 22 OHM J
R8706	76011103	CHIP, 1/20W 10K OHM J
R8707	76011103	CHIP, 1/20W 10K OHM J
R8709	76011101	CHIP, 1/20W 100 OHM J
R8710	76011101	CHIP, 1/20W 100 OHM J
R8711	76011223	CHIP, 1/20W 22K OHM J
R8712	76011473	CHIP, 1/20W 47K OHM J
R8713	76011103	CHIP, 1/20W 10K OHM J
R8714	76011102	CHIP, 1/20W 1K OHM J
R8715	76011102	CHIP, 1/20W 1K OHM J
R8716	76011103	CHIP, 1/20W 10K OHM J
R8801	76011102	CHIP, 1/20W 1K OHM J
R8802	76011102	CHIP, 1/20W 1K OHM J
R8803	76366221	CARBON FILM, 1/6W 220 OHM J

Location No.	Parts No.	Description
R8804	76871222	CHIP, 1/8W 2.2K OHM J
R8805	76011102	CHIP, 1/20W 1K OHM J
R8806	76011102	CHIP, 1/20W 1K OHM J
R8807	76011152	CHIP, 1/20W 1.5K OHM J
R8808	76011101	CHIP, 1/20W 100 OHM J
R8809	76011223	CHIP, 1/20W 22K OHM J
R8810	76000605	CHIP, 1/16W 6.8K OHM F
R8811	76190012	METAL FILM CHIP 1/16W 1.5K F
R8812	76000446	CHIP 1/16W 220 F
R8813	76000824	CHIP JUMPER, 2125TYPE
R8814	76011103	CHIP, 1/20W 10K OHM J
R8815	76872151	CHIP, 1/16W 150 OHM J
RA71	76011683	CHIP, 1/20W 68K OHM J
RA72	76011223	CHIP, 1/20W 22K OHM J
RA73	76011103	CHIP, 1/20W 10K OHM J
RA74	76000445	CHIP JUMPER, 1608TYPE
RA77	76011103	CHIP, 1/20W 10K OHM J
RA78	76000445	CHIP JUMPER, 1608TYPE
RA79	76000445	CHIP JUMPER, 1608TYPE
RB08	76011470	CHIP, 1/20W 47 OHM J
RB09	76011470	CHIP, 1/20W 47 OHM J
RB10	76011331	CHIP, 1/20W 330 OHM J
RB15	76011471	CHIP, 1/20W 470 OHM J
RB24	76000445	CHIP JUMPER, 1608TYPE
RC01	76011102	CHIP, 1/20W 1K OHM J
RC02	76011102	CHIP, 1/20W 1K OHM J
RC03	76011102	CHIP, 1/20W 1K OHM J
RC04	76011102	CHIP, 1/20W 1K OHM J
RC11	76011101	CHIP, 1/20W 100 OHM J
RC12	76011101	CHIP, 1/20W 100 OHM J
RC40	76011821	CHIP, 1/20W 820 OHM J
RC41	76011821	CHIP, 1/20W 820 OHM J
RE01	76366153	CARBON FILM, 1/6W 15K OHM J
RE02	76366473	CARBON FILM, 1/6W 47K OHM J
RE03	76366153	CARBON FILM, 1/6W 15K OHM J
RE06	76366473	CARBON FILM, 1/6W 47K OHM J
RE10	76367180	CARBON FILM, 1/6W 18 OHM G
RE11	76367222	CARBON FILM, 1/6W 2.2K OHM G
RE12	76366472	CARBON FILM, 1/6W 4.7K OHM J
RE13	76366102	CARBON FILM, 1/6W 1K OHM J
RE18	76366153	CARBON FILM, 1/6W 15K OHM J
RE19	76366473	CARBON FILM, 1/6W 47K OHM J
RE60	76000142	METAL FILM, 1/4W 240 OHM F
RE61	76000360	METAL FILM, 1/4W 1.2K OHM F
RE63	76366102	CARBON FILM, 1/6W 1K OHM J
RE65	76367620	CARBON FILM 1/6W 62 G
RE66	76367222	CARBON FILM, 1/6W 2.2K OHM G
RE90	76000358	METAL FILM, 1/4W 1K OHM F
RE91	76182046	METAL FILM 1/4W 680 F
RE92	76366101	CARBON FILM, 1/6W 100 OHM J
RE93	76366102	CARBON FILM, 1/6W 1K OHM J
RE94	76553680	OXIDE METAL FILM, 1W 68 OHM J
RE95	76552102	OXIDE METAL FILM, 1/2W 1K OHM J
RE96	76366473	CARBON FILM, 1/6W 47K OHM J
RE97	76366472	CARBON FILM, 1/6W 4.7K OHM J
RE98	76366473	CARBON FILM, 1/6W 47K OHM J
RE99	76366101	CARBON FILM, 1/6W 100 OHM J
RR01	76871750	CHIP, 1/8W 75 OHM J
RR02	76871750	CHIP, 1/8W 75 OHM J
RR03	76871750	CHIP, 1/8W 75 OHM J
RR04	76011330	CHIP, 1/20W 33 OHM J
RR05	76011330	CHIP, 1/20W 33 OHM J
RR06	76011330	CHIP, 1/20W 33 OHM J
RT01	76011222	CHIP, 1/20W 2.2K OHM J
RT02	76011223	CHIP, 1/20W 22K OHM J
RT03	76011683	CHIP, 1/20W 68K OHM J
RT04	76011102	CHIP, 1/20W 1K OHM J
RT05	76011101	CHIP, 1/20W 100 OHM J
RT06	76011221	CHIP, 1/20W 220 OHM J
RT07	76011561	CHIP, 1/20W 560 OHM J
RT08	76011221	CHIP, 1/20W 220 OHM J
RT09	76011471	CHIP, 1/20W 470 OHM J
RT10	76011222	CHIP, 1/20W 2.2K OHM J
RT11	76011223	CHIP, 1/20W 22K OHM J
RT12	76011683	CHIP, 1/20W 68K OHM J
RT13	76011102	CHIP, 1/20W 1K OHM J

Location No.	Parts No.	Description
RT14	76011101	CHIP, 1/20W 100 OHM J
RT15	76011151	CHIP, 1/20W 150 OHM J
RT16	76011391	CHIP, 1/20W 390 OHM J
RT17	76011181	CHIP, 1/20W 180 OHM J
RT18	76011471	CHIP, 1/20W 470 OHM J
RT19	76011222	CHIP, 1/20W 2.2K OHM J
RT20	76011223	CHIP, 1/20W 22K OHM J
RT21	76011683	CHIP, 1/20W 68K OHM J
RT22	76011102	CHIP, 1/20W 1K OHM J
RT23	76011101	CHIP, 1/20W 100 OHM J
RT24	76011151	CHIP, 1/20W 150 OHM J
RT25	76011391	CHIP, 1/20W 390 OHM J
RT26	76011221	CHIP, 1/20W 220 OHM J
RT27	76011471	CHIP, 1/20W 470 OHM J
RT28	76011103	CHIP, 1/20W 10K OHM J
RT29	76011103	CHIP, 1/20W 10K OHM J
RV11	76011223	CHIP, 1/20W 22K OHM J
RV12	76011473	CHIP, 1/20W 47K OHM J
RV21	76011750	CHIP, 1/20W 75 OHM J
RV25	76011750	CHIP, 1/20W 75 OHM J
RV26	76011750	CHIP, 1/20W 75 OHM J
RV27	76011750	CHIP, 1/20W 75 OHM J
RV28	76011750	CHIP, 1/20W 75 OHM J
RV29	76011750	CHIP, 1/20W 75 OHM J
RV30	76011750	CHIP, 1/20W 75 OHM J
RV35	76000445	CHIP JUMPER, 1608TYPE
RV36	76000445	CHIP JUMPER, 1608TYPE
RV37	76000445	CHIP JUMPER, 1608TYPE
RV43	76011101	CHIP, 1/20W 100 OHM J
RV51	76011101	CHIP, 1/20W 100 OHM J
RV52	76872271	CHIP, 1/16W 270 OHM J
RV54	76011473	CHIP, 1/20W 47K OHM J
RV55	76011473	CHIP, 1/20W 47K OHM J
RV56	76011473	CHIP, 1/20W 47K OHM J
RV57	76011101	CHIP, 1/20W 100 OHM J
RV58	76872271	CHIP, 1/16W 270 OHM J
RV59	76011473	CHIP, 1/20W 47K OHM J
RV60	76011102	CHIP, 1/20W 1K OHM J
RV61	76000445	CHIP JUMPER, 1608TYPE
RV62	76000445	CHIP JUMPER, 1608TYPE
RV63	76011470	CHIP, 1/20W 47 OHM J
RV64	76011470	CHIP, 1/20W 47 OHM J
RV65	76011470	CHIP, 1/20W 47 OHM J
RV66	76011470	CHIP, 1/20W 47 OHM J
RV71	76011473	CHIP, 1/20W 47K OHM J
RV72	76872271	CHIP, 1/16W 270 OHM J
RV73	76011101	CHIP, 1/20W 100 OHM J
RV74	76011473	CHIP, 1/20W 47K OHM J
RV76	76011473	CHIP, 1/20W 47K OHM J
RV78	76011101	CHIP, 1/20W 100 OHM J
RV79	76872271	CHIP, 1/16W 270 OHM J
RV80	76011473	CHIP, 1/20W 47K OHM J
RV91	76000445	CHIP JUMPER, 1608TYPE
RV120	76011750	CHIP, 1/20W 75 OHM J
RV123	76872750	CHIP, 1/16W 75 OHM J
GE92	76366161	CARBON FILM 1/6W 160 J
GJ414	76000445	CHIP JUMPER, 1608TYPE
GR01	76000445	CHIP JUMPER, 1608TYPE
GR02	76000445	CHIP JUMPER, 1608TYPE
GR03	76000445	CHIP JUMPER, 1608TYPE
GR05	76000445	CHIP JUMPER, 1608TYPE
GR06	76000445	CHIP JUMPER, 1608TYPE
GR25	76000445	CHIP JUMPER, 1608TYPE
GR26	76000445	CHIP JUMPER, 1608TYPE
GR27	76000445	CHIP JUMPER, 1608TYPE
GR28	76000445	CHIP JUMPER, 1608TYPE
GR30	76000445	CHIP JUMPER, 1608TYPE
GR31	76000445	CHIP JUMPER, 1608TYPE
GR34	76000445	CHIP JUMPER, 1608TYPE
GR35	76000445	CHIP JUMPER, 1608TYPE
GR413	76000445	CHIP JUMPER, 1608TYPE
GR605	76000445	CHIP JUMPER, 1608TYPE
GRV03	76000445	CHIP JUMPER, 1608TYPE
GRV04	76000445	CHIP JUMPER, 1608TYPE
GT01	76000445	CHIP JUMPER, 1608TYPE
GT02	76000445	CHIP JUMPER, 1608TYPE

Location No.	Parts No.	Description
GT03	76000445	CHIP JUMPER, 1608TYPE
GV01	76000445	CHIP JUMPER, 1608TYPE
COILS & TRANSFORMERS		
L101	23248398	COIL, CHOKE, TLN3278D
L102	23103828	INDUCTOR, BEAD, TEM2121M
L103	23103828	INDUCTOR, BEAD, TEM2121M
L191	23103828	INDUCTOR, BEAD, TEM2121M
L505	23289022	COIL, PEAKING, TRF4100AT
L820	23248491	COIL, CHOKE 26X13 108MMH 5A TLN3641AF
L821	23248491	COIL, CHOKE 26X13 108MMH 5A TLN3641AF
L824	23103330	FILTER, FERRITE CHOKE 3.5X5X2 TEM2014AH
L825	23103304	FERRITE CHOKE, TEM2011AA
L840	23289981	COIL, PEAKING, TRF4330AZ
L860	23103320	COIL, CHOKE, TEM2011
L862	23103320	COIL, CHOKE, TEM2011
L870	23103320	COIL, CHOKE, TEM2011
L871	23103320	COIL, CHOKE, TEM2011
L878	23248489	COIL, CHOKE COIL 1.5MMH 8A TLN3639AH
L880	23103304	FERRITE CHOKE, TEM2011AA
L881	23248388	COIL, CHOKE 9X11H 4.7MMHK 4.0A TLN3515AA
L883	23103304	FERRITE CHOKE, TEM2011AA
L884	23248387	COIL, CHOKE 9X11H 22MMHK 2.5ATLN3499AA
L886	23103304	FERRITE CHOKE, TEM2011AA
L8211	23103330	FILTER, FERRITE CHOKE 3.5X5X2 TEM2014AH
L8212	23103330	FILTER, FERRITE CHOKE 3.5X5X2 TEM2014AH
LC01	23103828	INDUCTOR, BEAD, TEM2121M
LC02	23103828	INDUCTOR, BEAD, TEM2121M
LC31	23103238	INDUCTOR, BEAD, TEM2142AD
LC32	23103238	INDUCTOR, BEAD, TEM2142AD
LC33	23103238	INDUCTOR, BEAD, TEM2142AD
LE10	23289980	COIL, PEAKING, TRF4220AZ
LE60	23248456	COIL, CHOKE, TLN3540AH
LE61	23289980	COIL, PEAKING, TRF4220AZ
LE62	23248432	COIL, CHOKE, TLN3499AH
LE90	23248456	COIL, CHOKE, TLN3540AH
LE91	23289980	COIL, PEAKING, TRF4220AZ
LE92	23248432	COIL, CHOKE, TLN3499AH
LT01	23289027	COIL, PEAKING, TRF4680AT
LT02	23289072	COIL, PEAKING, TRF4151AT
LT03	23289072	COIL, PEAKING, TRF4151AT
△ T801	23211904	COIL, LINE FILTER 35X34H 10MH TRF3255AF
△ T802	23211904	COIL, LINE FILTER 35X34H 10MH TRF3255AF
△ T820	23217799	TRANSFORMER, CONVERTER TPW3564AS
△ T822	23248490	COIL, CHOKE EI25 5.3MMH 8.0A TLN3640AH
△ T840	23217800	TRANSFORMER, CONVERTER TPW3565AS
△ T860	23217802	TRANSFORMER, CONVERTER TPW3567AS
△ T880	23217801	TRANSFORMER, CONVERTER TPW3566AS
ZA01	23103840	FERRITE CORE, TFE1013
ZA03	23103778	FERRITE CORE, TFE1008
SEMICONDUCTORS		
IC414	23085936	IC, BU4245G-TR
Q101	23205506	TRANSISTOR, 2SC4081 Q
Q501	23085049	IC, TB1274BFG(DRY)
Q504	23205507	TRANSISTOR, 2SA1576A Q
Q654	23205302	TRANSISTOR, 2SC3326-B(F)
Q655	23205302	TRANSISTOR, 2SC3326-B(F)
Q656	23205325	TRANSISTOR, RN2404(F)
Q660	23205506	TRANSISTOR, 2SC4081 Q
Q661	23205506	TRANSISTOR, 2SC4081 Q
Q662	23205325	TRANSISTOR, RN2404(F)
Q663	23205506	TRANSISTOR, 2SC4081 Q
Q670	23085039	IC, TA8246AHQ
Q671	23205302	TRANSISTOR, 2SC3326-B(F)
Q672	23205302	TRANSISTOR, 2SC3326-B(F)
Q673	23205443	TRANSISTOR, 2SA1162-Y(F)
Q812	23205506	TRANSISTOR, 2SC4081 Q
△ Q813	23000823	IC, PHOTO COUPLER, TLP421F(GR)
Q814	23205506	TRANSISTOR, 2SC4081 Q
Q815	23205506	TRANSISTOR, 2SC4081 Q
Q816	23205506	TRANSISTOR, 2SC4081 Q
Q820	23135094	IC, PFC 7PIN SRX2039
△ Q821	23000823	IC, PHOTO COUPLER, TLP421F(GR)
Q822	23205339	TRANSISTOR, 2SC2655-Y(F)
Q840	23135083	IC, HYBRID VDSS=800V

Location No.	Parts No.	Description
△ Q841	23000823	IC, PHOTO COUPLER, TLP421F(GR)
Q842	23085389	IC, NJM431L
Q860	23135066	IC, STRZ4479
△ Q862	23000823	IC, PHOTO COUPLER, TLP421F(GR)
△ Q863	23000823	IC, PHOTO COUPLER, TLP421F(GR)
Q864	23205339	TRANSISTOR, 2SC2655-Y(F)
Q870	23085389	IC, NJM431L
Q880	23135072	IC, STRW6765
△ Q881	23000823	IC, PHOTO COUPLER, TLP421F(GR)
Q882	23085389	IC, NJM431L
Q4100	23085635	TRANSISTOR, 2SC3437-Y(TE85L,F)
Q4101	23085635	TRANSISTOR, 2SC3437-Y(TE85L,F)
Q4102	23085635	TRANSISTOR, 2SC3437-Y(TE85L,F)
Q4103	23085635	TRANSISTOR, 2SC3437-Y(TE85L,F)
Q8191	23205506	TRANSISTOR, 2SC4081 Q
Q8230	23205328	TRANSISTOR, RN1405(F)
Q8231	23205506	TRANSISTOR, 2SC4081 Q
Q8310	23205328	TRANSISTOR, RN1405(F)
Q8311	23205506	TRANSISTOR, 2SC4081 Q
Q8312	23205506	TRANSISTOR, 2SC4081 Q
Q8390	23205506	TRANSISTOR, 2SC4081 Q
△ Q8391	23000823	IC, PHOTO COUPLER, TLP421F(GR)
Q8601	23205329	TRANSISTOR, RN1404(F)
Q8602	23205506	TRANSISTOR, 2SC4081 Q
Q8701	23205506	TRANSISTOR, 2SC4081 Q
Q8702	23205329	TRANSISTOR, RN1404(F)
Q8703	23205328	TRANSISTOR, RN1405(F)
Q8704	23085338	IC, BD5245G-TR
Q8801	23205329	TRANSISTOR, RN1404(F)
Q8802	23205329	TRANSISTOR, RN1404(F)
QB04	23205463	TRANSISTOR, 2SC2712-Y(TE85L,F)
QB07	23205463	TRANSISTOR, 2SC2712-Y(TE85L,F)
QE01	23205376	TRANSISTOR, 2SC5343-YLK)
QE02	23205376	TRANSISTOR, 2SC5343-YLK)
QE03	23205315	TRANSISTOR, RN1206(F)
QE10	23135077	IC, SI-3090CA
QE11	23205315	TRANSISTOR, RN1206(F)
QE60	23085381	IC, SI-8050SS
QE65	23135076	IC, SI-3050C
QE90	23085381	IC, SI-8050SS
QE91	23205376	TRANSISTOR, 2SC5343-YLK)
QE92	23205339	TRANSISTOR, 2SC2655-Y(F)
QE93	23205315	TRANSISTOR, RN1206(F)
QE95	23205442	TRANSISTOR, 2SC3852
QT01	23205507	TRANSISTOR, 2SA1576A Q
QT02	23205506	TRANSISTOR, 2SC4081 Q
QT03	23205507	TRANSISTOR, 2SA1576A Q
QT04	23205507	TRANSISTOR, 2SA1576A Q
QT05	23205506	TRANSISTOR, 2SC4081 Q
QT06	23205507	TRANSISTOR, 2SA1576A Q
QT07	23205507	TRANSISTOR, 2SA1576A Q
QT08	23205506	TRANSISTOR, 2SC4081 Q
QT09	23205507	TRANSISTOR, 2SA1576A Q
QT10	23085758	IC, VIDEO SW 5IN-1OUT BA7649AF
QT11	23205402	TRANSISTOR, DTC144EUA
QT12	23205402	TRANSISTOR, DTC144EUA
QV06	23205507	TRANSISTOR, 2SA1576A Q
QV14	23085791	IC, M1510XNRE
QV51	23205506	TRANSISTOR, 2SC4081 Q
QV52	23205506	TRANSISTOR, 2SC4081 Q
QV53	23205506	TRANSISTOR, 2SC4081 Q
QV54	23205506	TRANSISTOR, 2SC4081 Q
D670	23362140	DIODE, KDS160-R TK
D671	23362140	DIODE, KDS160-R TK
D674	23362140	DIODE, KDS160-R TK
D675	23362140	DIODE, KDS160-R TK
D677	23362140	DIODE, KDS160-R TK
D678	23362140	DIODE, KDS160-R TK
D809	76000656	VARISTOR, TNR15G471K
D811	23357841	DIODE, ZENER, MTZJ6.8A
D815	23357692	DIODE, ZENER, RD2.0ESA B2
D816	23357738	DIODE, ZENER, MA8047-L
D819	23357718	THYRISTOR, SF0R3G42(N,G5H1)
D820	23357913	DIODE, RBV-1506, LF-A
D821	23362240	DIODE, VRM=1200V IF(AV)=3A FMC-26UAR
D822	23362220	DIODE, VRM=600V IF=5A FMX-G16S

Location No.	Parts No.	Description
D823	23362223	DIODE, VRM=600V IF=1.2A DO201AD :RM3A,LF014-102
D825	23357899	DIODE, ZENER, MTZJ33A
D826	23357513	DIODE, EU2A
D828	76000656	VARISTOR, TNR15G471K
D841	23362221	DIODE, VRM=1000V 1.0A EM1C ,LF-F7
D842	23362221	DIODE, VRM=1000V 1.0A EM1C ,LF-F7
D843	23357854	DIODE, ZENER, MTZJ10B
D844	23357837	DIODE, ZENER, MTZJ5.6B
D845	23357510	DIODE, AG01
D846	23357513	DIODE, EU2A
D860	23357850	DIODE, ZENER, MTZJ9.1A
D861	23357893	DIODE, ZENER, MTZJ27C
D862	23357893	DIODE, ZENER, MTZJ27C
D863	23357854	DIODE, ZENER, MTZJ10B
D864	23357854	DIODE, ZENER, MTZJ10B
D865	23357513	DIODE, EU2A
D866	23357853	DIODE, ZENER, MTZJ10A
D870	23362219	DIODE, VRM=100V IF=20A FME-220A(023-108)
D871	23362219	DIODE, VRM=100V IF=20A FME-220A(023-108)
D874	23362219	DIODE, VRM=100V IF=20A FME-220A(023-108)
D880	23357513	DIODE, EU2A
D881	23357104	DIODE, 1SS244
D882	23357104	DIODE, 1SS244
D883	23357837	DIODE, ZENER, MTZJ5.6B
D884	23362219	DIODE, VRM=100V IF=20A FME-220A(023-108)
D885	23357513	DIODE, EU2A
D886	23357408	DIODE, FMX-12S(023-108)
D887	23357900	DIODE, ZENER, MTZJ33B
D888	23357848	DIODE, ZENER, MTZJ8.2B
D889	23357848	DIODE, ZENER, MTZJ8.2B
D890	23357847	DIODE, ZENER, MTZJ8.2A
D891	23357847	DIODE, ZENER, MTZJ8.2A
D892	23357892	DIODE, ZENER, MTZJ27B
D8230	23357792	DIODE, ZENER 22.80-23.97 MA8240-L, TX
D8231	23357703	DIODE, 1SS355
D8232	23357745	DIODE, ZENER, MA8056-M
D8271	23357697	DIODE, 1SS133
D8272	23357910	DIODE, ZENER, MTZJ39D
D8273	23357883	DIODE, ZENER, MTZJ22A
D8274	23357883	DIODE, ZENER, MTZJ22A
D8310	23357703	DIODE, 1SS355
D8311	23357745	DIODE, ZENER, MA8056-M
D8312	23357703	DIODE, 1SS355
D8313	23357762	DIODE, ZENER, MA8091-M
D8390	23357889	DIODE, ZENER, MTZJ24C
D8391	23357890	DIODE, ZENER, MTZJ24D
D8401	23357703	DIODE, 1SS355
D8402	23357703	DIODE, 1SS355
D8403	23357703	DIODE, 1SS355
D8404	23357703	DIODE, 1SS355
D8601	23357703	DIODE, 1SS355
D8602	23357731	DIODE, ZENER, MA8033-H
D8701	23357703	DIODE, 1SS355
D8702	23357703	DIODE, 1SS355
D8705	23357894	DIODE, ZENER, MTZJ27D
D8706	23357703	DIODE, 1SS355
D8801	23357703	DIODE, 1SS355
D8802	23357703	DIODE, 1SS355
D8803	23357778	DIODE, ZENER, MA8150-M
D8804	23357703	DIODE, 1SS355
D8805	23357745	DIODE, ZENER, MA8056-M
DA01	23357751	DIODE, ZENER, MA8068-M
DA06	23357751	DIODE, ZENER, MA8068-M
DA07	23357751	DIODE, ZENER, MA8068-M
DB01	23358606	DIODE, LED RED, SLR-56VC3FPQ
DB04	23358605	DIODE, LED GREEN, SLR-56MC3FPQR
DB20	23357406	DIODE, ZENER, UDZS5.6B
DB22	23357703	DIODE, 1SS355
DB23	23357703	DIODE, 1SS355
DE01	23357706	DIODE, AK04
DE02	23357706	DIODE, AK04
DE03	23357823	DIODE, ZENER, MTZJ3.6A
DE07	23357821	DIODE, ZENER, MTZJ3.3A
DE60	23357810	DIODE, FMB-G14L
DE61	23357697	DIODE, 1SS133
DE62	23357845	DIODE, ZENER, MTZJ7.5B

Location No.	Parts No.	Description
DE90	23357810	DIODE, FMB-G14L
DE91	23357697	DIODE, 1SS133
DE92	23357871	DIODE, ZENER, MTZJ15B
DE97	23357895	DIODE, ZENER, MTZJ30A
DE99	23357840	DIODE, ZENER, MTZJ6.2B
MISCELLANEOUS		
A235	23717214	SCREW, BITTB3X12SBN
A370	23717267	SCREW, BITTB4X16 SBN
A375	23717214	SCREW, BITTB3X12SBN
A410	23717361	SCREW, PP3X8+SW+W SBN LOCK
A411	23717267	SCREW, BITTB4X16 SBN
A440	23738074	SCREW, PP 5X16 SW+W SBN
△ B001	23301656	DISPLAY, G5LPL42
△ B215	23469405	INSULATOR, INSULATOR AC
B310	23717219	SCREW, PP3X8+SW+W SBN
B315	23717214	SCREW, BITTB3X12SBN
△ F801	23144406	FUSE, CERA 5X20 250V 6.3A
F801A	23165433	FUSE HOLDER, 5.2
F801B	23165433	FUSE HOLDER, 5.2
△ F820	23144378	FUSE, RADIAL LEAD SUB-MINIATUR 250V 2A
△ F870	23144378	FUSE, RADIAL LEAD SUB-MINIATUR 250V 2A
KB01	23009710	REMOCON RECEIVER, GP1UE281RK
MJ22	23389359	CABLE, FFC 0.5 50P L70 GOLD
MJ60	23389359	CABLE, FFC 0.5 50P L70 GOLD
MZ01	23368908	CABLE, LVDS30P170MM SHP T2 E30-X30
P602A	23713937	CONNECTOR, PLUG 4P B4B-PH-K-S(LF)
P602B	23713946	CONNECTOR, PLUG 4P S4B-PH-K-S(LF)
P661	23023302	EARPHONE JACK
△ P801 #1	23372294	POWER CORD, SAA 2.3M 7.5A —2 @E113 42WL55A
△ #2	23372356	POWER CORD, UK-HK-PSB 10A MP5004SC @E111 42WL55E
△ #3	23372298	POWER CORD, 250V2.5A @E114 42WL55R
△ #4	23372297	POWER CORD, CEE @E112 42WL55T
△ P801A	23713702	PLUG, 2P 11.88MM W VT
P803A	23713764	PLUG, 13P
P803B	23713764	PLUG, 13P
P807A	23713764	PLUG, 13P
P807B	23713764	PLUG, 13P
P809A	23713763	PLUG, NP 2.5MM G, B12B-EH-F1A
P809B	23713763	PLUG, NP 2.5MM G, B12B-EH-F1A
P860	23713942	CONNECTOR, CONNECT B10B-PH-K-S(LF)
P861	23713942	CONNECTOR, CONNECT B10B-PH-K-S(LF)
P900	23713941	CONNECTOR, CONNECT B9B-PH-K-S(LF)
P900A	23713941	CONNECTOR, CONNECT B9B-PH-K-S(LF)
PG01	23165495	TERMINAL, EARTH PHI3 MET31-0332
PG03	23165495	TERMINAL, EARTH PHI3 MET31-0332
PJ21A	23713934	CONNECTOR, 2MM 3P S WHT B3B-PH-K-S(LF)
PJ22	23757180	CONNECTOR, FH12-50S-0.5SV(55)
PJ22A	23757176	CONNECTOR, IRS 9637S-50Y902 GLD
PJ41	23713943	CONNECTOR, CONNECT B11B-PH-K-S(LF)
PJ41A	23713943	CONNECTOR, CONNECT B11B-PH-K-S(LF)
PJ42	23713939	CONNECTOR, CONNECT B6B-PH-K-S(LF)
PJ42A	23713948	CONNECTOR, CONNECT S6B-PH-K-S(LF)
PJ60	23757180	CONNECTOR, FH12-50S-0.5SV(55)
PJ60A	23757176	CONNECTOR, IRS 9637S-50Y902 GLD
PJ930	23713574	CONNECTOR, 7P TOPTYPE BM07B-SRSS-TBT(LF)
PP01	23845859	HOLDER, WIRE, PVC-COAT, L=70MM
PP07	23528292	HOLDER, ABMM-A-D, (NO SERVICE)
PP08	23974994	BAND, KESSOKU
PP12	23974994	BAND, KESSOKU
PP22	23748085	WASHER, WASHER 10X4.2XT=0.3
PV01	23023418	JACK, PIN RA 3/3P SMK T-3/3P
PV03	23023423	JACK, PIN RA 3P SMK T-4P
PV04	23023419	JACK, PIN RA RESERVE RESERVE T-2P
PV11	23023423	JACK, PIN RA 3P SMK T-4P
PV17	23023302	EARPHONE JACK
PV22	23023418	JACK, PIN RA 3/3P SMK T-3/3P
PV25A	23713944	CONNECTOR, CONNECT B12B-PH-K-S(LF)
PV60	23365275	JACK, PHONO 3P V-L-R YKC21
PV90	23713710	SOCKET, D-SUB 15P, KR-D-8622
SA01	23344505	SWITCH, PUSH 1C1P
SA02	23344505	SWITCH, PUSH 1C1P
SA03	23344505	SWITCH, PUSH 1C1P
SA04	23344505	SWITCH, PUSH 1C1P
SA05	23344505	SWITCH, PUSH 1C1P
SA06	23344505	SWITCH, PUSH 1C1P

Location No.	Parts No.	Description
SA07	23344505	SWITCH, PUSH 1C1P
△ SR80	23146588	RELAY, DLS5D1-O(M) 0.15W
△ SR81	23146584	RELAY, DC12V, TV5, DG-3
W661	23351322	SPEAKER, ASSY, 6X12+6X12+TW SPK-1470BO
W661A	23845856	CLAMP, WIRE, POF COAT) L=70MM
X501	23153612	CRYSTAL, 16.200 25PPM 25OHM
PC BOARD ASSEMBLIES		
* U001	75001650	PC BOARD ASSY, PD2238C1 SIGNAL
* U002A	75001651	PC BOARD ASSY, PD2171D1 POWER
* U002B	75001652	PC BOARD ASSY, PD2171D2 AC IN
* U003A	75001645	PC BOARD ASSY, PD2224A1 TN AV
* U003B	75001646	PC BOARD ASSY, PD2224A2 FRONT AV
* U003C	75001647	PC BOARD ASSY, PD2224A3 RMT LED
* U003D	75001648	PC BOARD ASSY, PD2224A4 KEY
* U003E	75001649	PC BOARD ASSY, PD2224A5 PC INPUT
* U004	75001734	PC BOARD ASSY, PD2173C1 LOWB
TUNER		
△ H001	23321499	TUNER, ENG39A07GF, TIF CHI HOR61 IEC PAL+M
ACCESSORIES		
A701A #1	23015172	CARTON, TOP CASE
A701B	23015173	CARTON, BOTTOM CASE
A701E #2	23015172	CARTON, TOP CASE
A701R #3	23015174	CARTON, TOP CASE
A701T #4	23015172	CARTON, TOP CASE
A702A	23580040	PACKING, TOP PACKING
A702B	23580041	PACKING, BOTTOM PACKING
A705	23518043	PACKING, JOINT, 3Z25P
A709	23946938	PACKING, CENTER PACKING
△ Y101A #1	23566722	OWNERS MANUAL, ENGL LCD @E113 42WL55A
△ #2	23566722	OWNERS MANUAL, ENGL LCD @E111 42WL55E
△ #3	23566721	OWNERS MANUAL, ENGL/RUSIA LCD @E114 42WL55R
△ #4	23566722	OWNERS MANUAL, ENGL LCD @E112 42WL55T
△ Y101H #2	23566723	OWNERS MANUAL, CT LCD 42WL55E
△ Y101J #2	23566724	OWNERS MANUAL, ARABIC LCD 42WL55E
△ Y101K #4	23566725	OWNERS MANUAL, THAI LCD
△ Y130	23306590	REMOCON HAND UNIT, CT-90126
Y170	23845800	HOLDER, WIRE, NYLON66 D6.8
CABINET PARTS		
A201	23533584	COVER, FRONT BEZEL ASSY
A320	23940489	PIECE, FRONT AV ASSY
A340	23940440	PIECE, CONTROL HOLDER ASSY
△ A401	23533590	COVER, BACK COVER
A420	23436883	FOOT, STAND ASSY
A445	23533496	COVER, BC STAND COVER
A450	23533495	COVER, BACK TERMINAL

Location No.	Parts No.	Description
--------------	-----------	-------------

POWER BOARD PD2171D1 (U002A)
BOTTOM (FOIL) SIDE

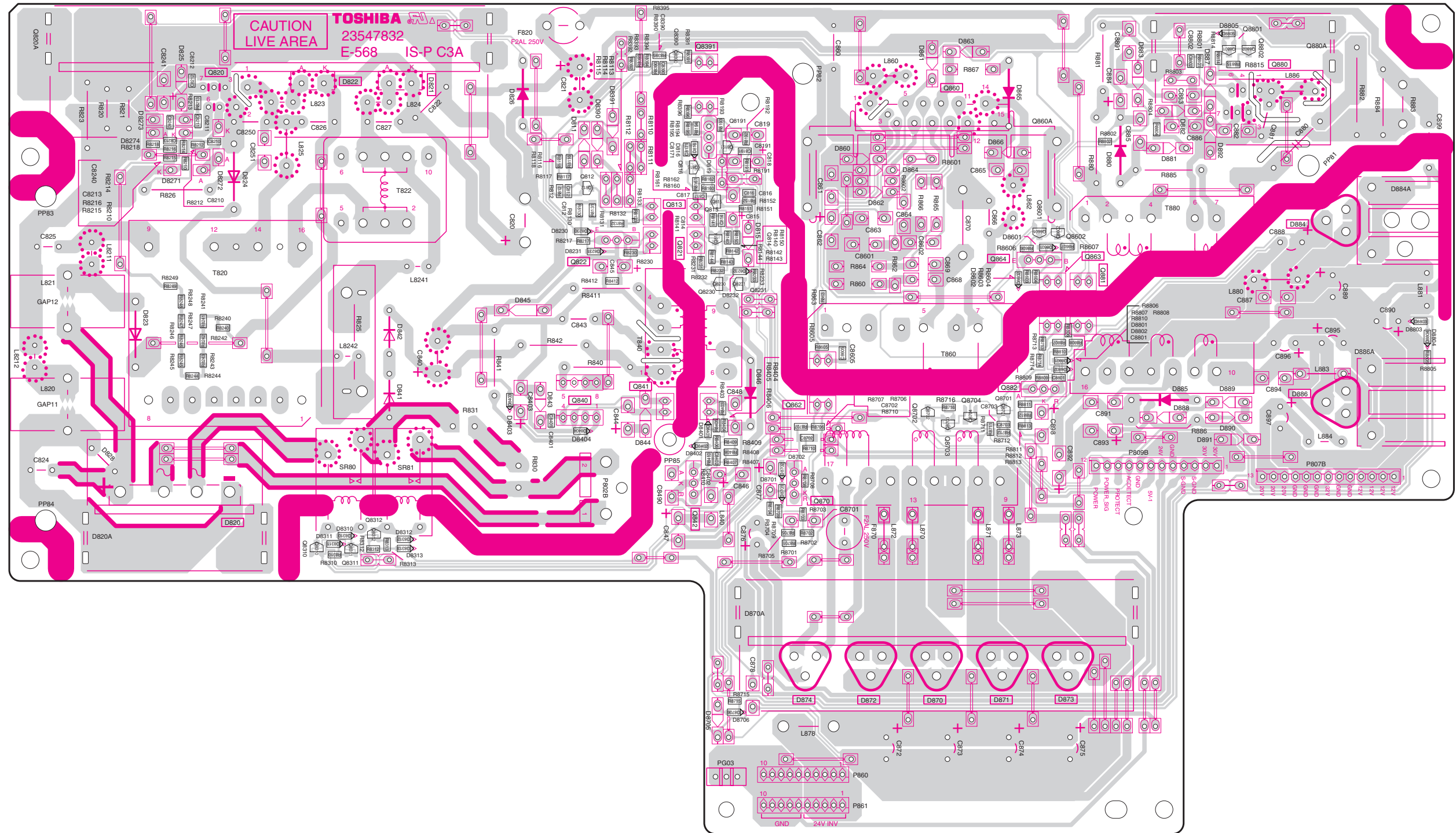

TN AV BOARD PD2224A1 (U003A)
BOTTOM (FOIL) SIDE

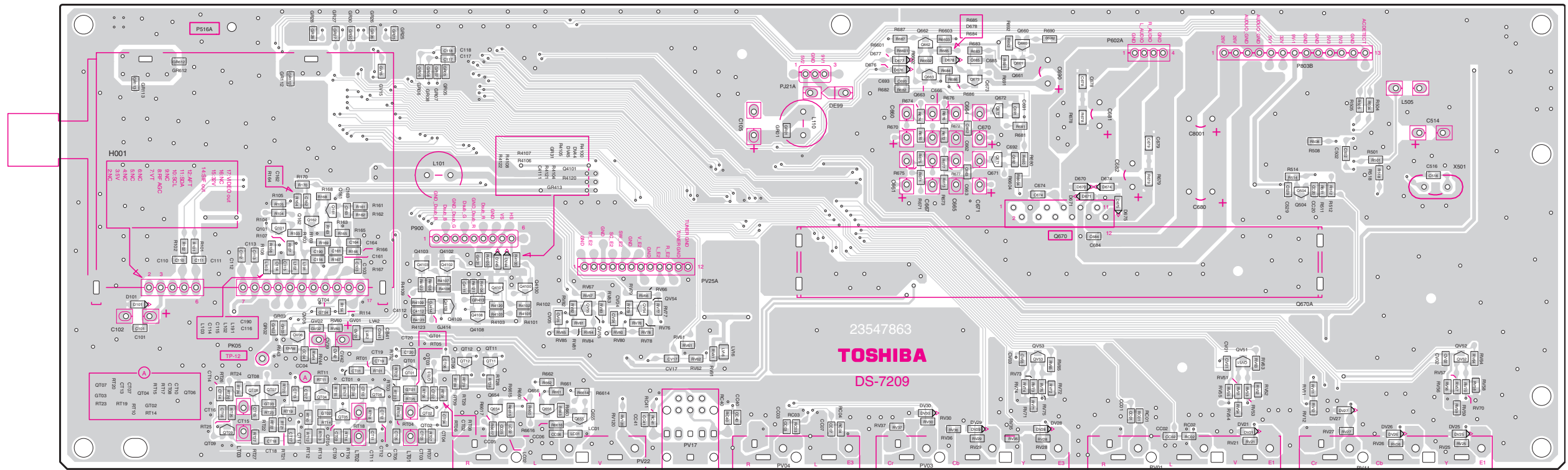

TN AV BOARD PD2224A1 (U003A)
TOP (COMPONENT) SIDE

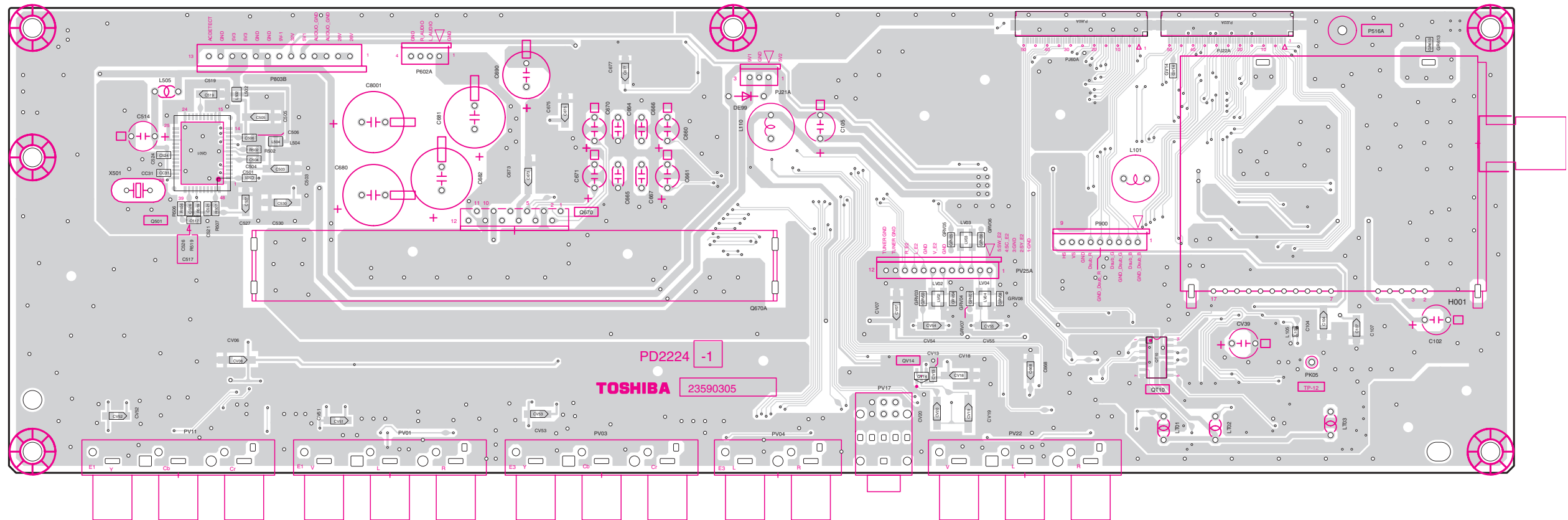

FRONT AV BOARD PD2224A2 (U003B)
BOTTOM (FOIL) SIDE

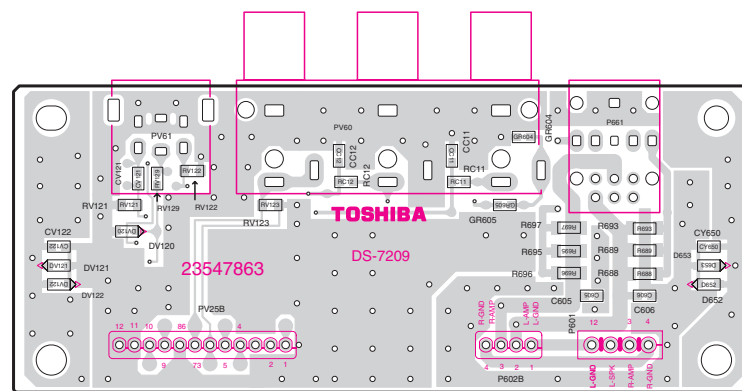

FRONT AV BOARD PD2224A2 (U003B)
TOP (COMPONENT) SIDE

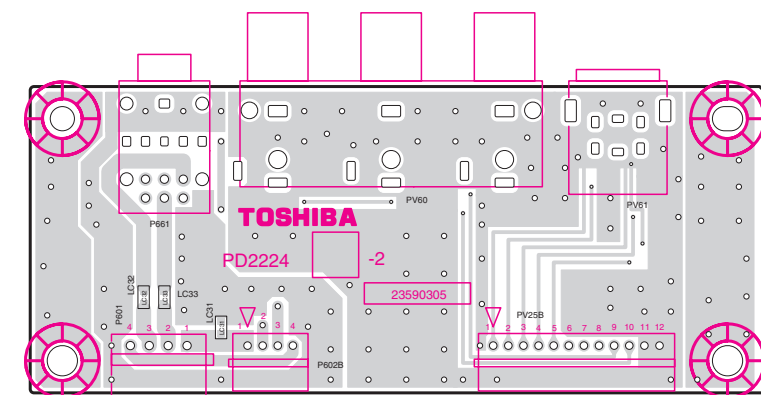

RMT LED BOARD PD2224A3 (U003C)
BOTTOM (FOIL) SIDE

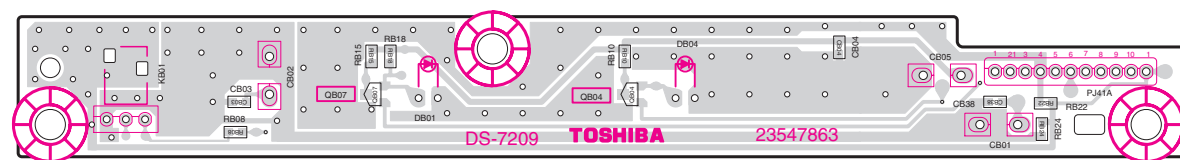

RMT LED BOARD PD2224A3 (U003C)
TOP (COMPONENT) SIDE

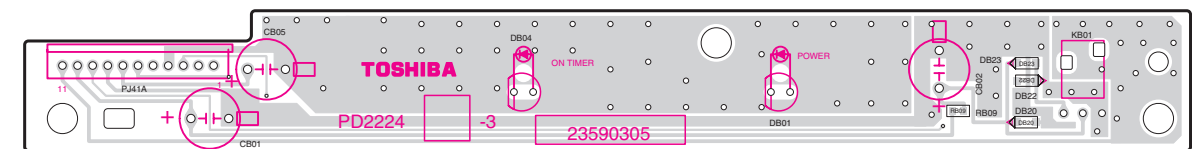

KEY BOARD PD2224A4 (U003D)
BOTTOM (FOIL) SIDE

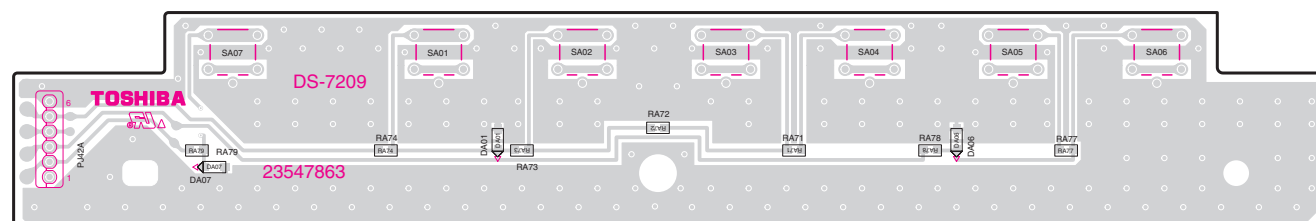

KEY BOARD PD2224A4 (U003D)
TOP (COMPONENT) SIDE

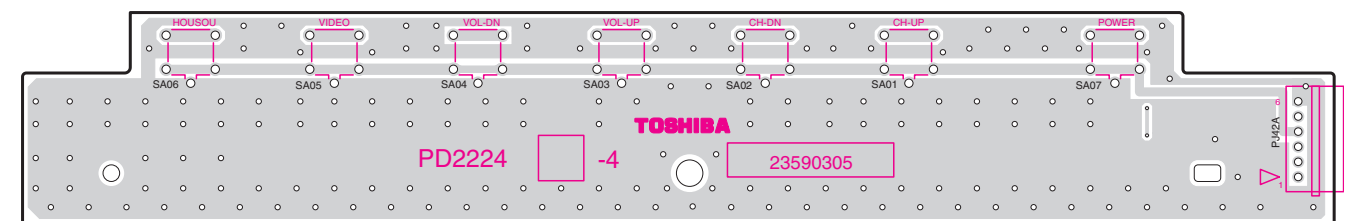

PC INPUT BOARD PD2224A5 (U003E)
BOTTOM (FOIL) SIDE

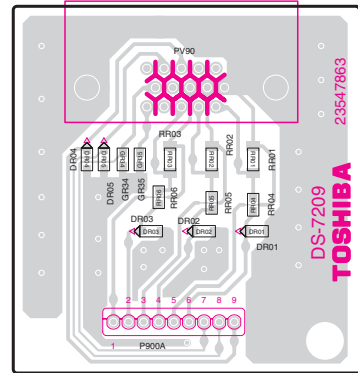

PC INPUT BOARD PD2224A5 (U003E)
TOP (COMPONENT) SIDE

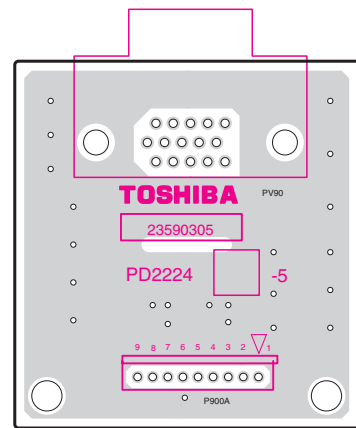

AC IN BOARD PD2171D2 (U002B)
BOTTOM (FOIL) SIDE

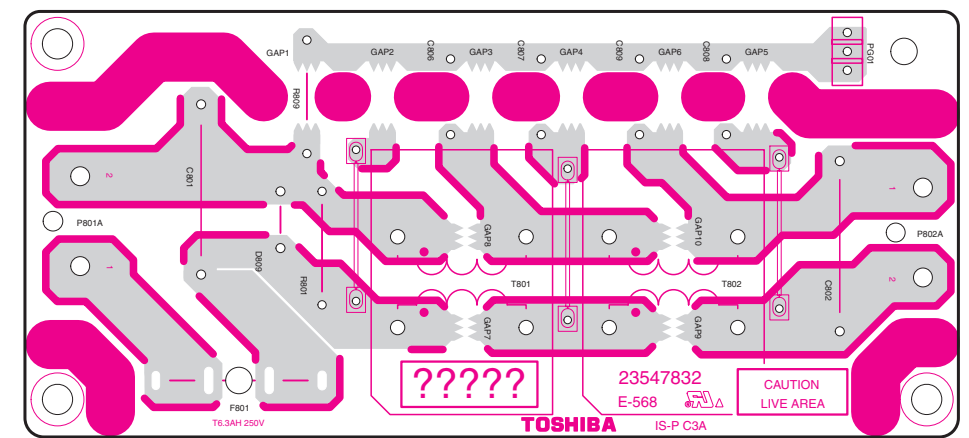

LOW B BOARD PD2173C1 (U004)
BOTTOM (FOIL) SIDE

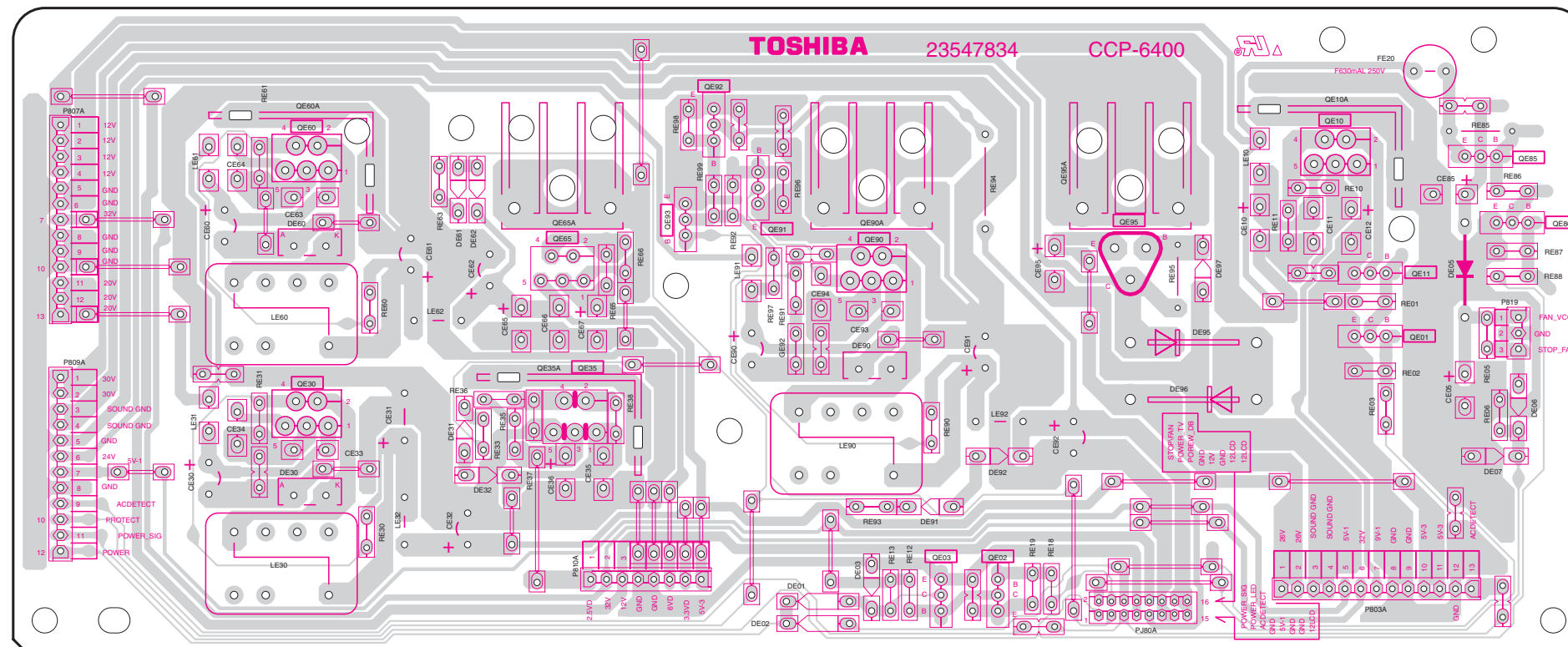

SIGNAL BOARD PD2238C1 (U001)
BOTTOM (FOIL) SIDE

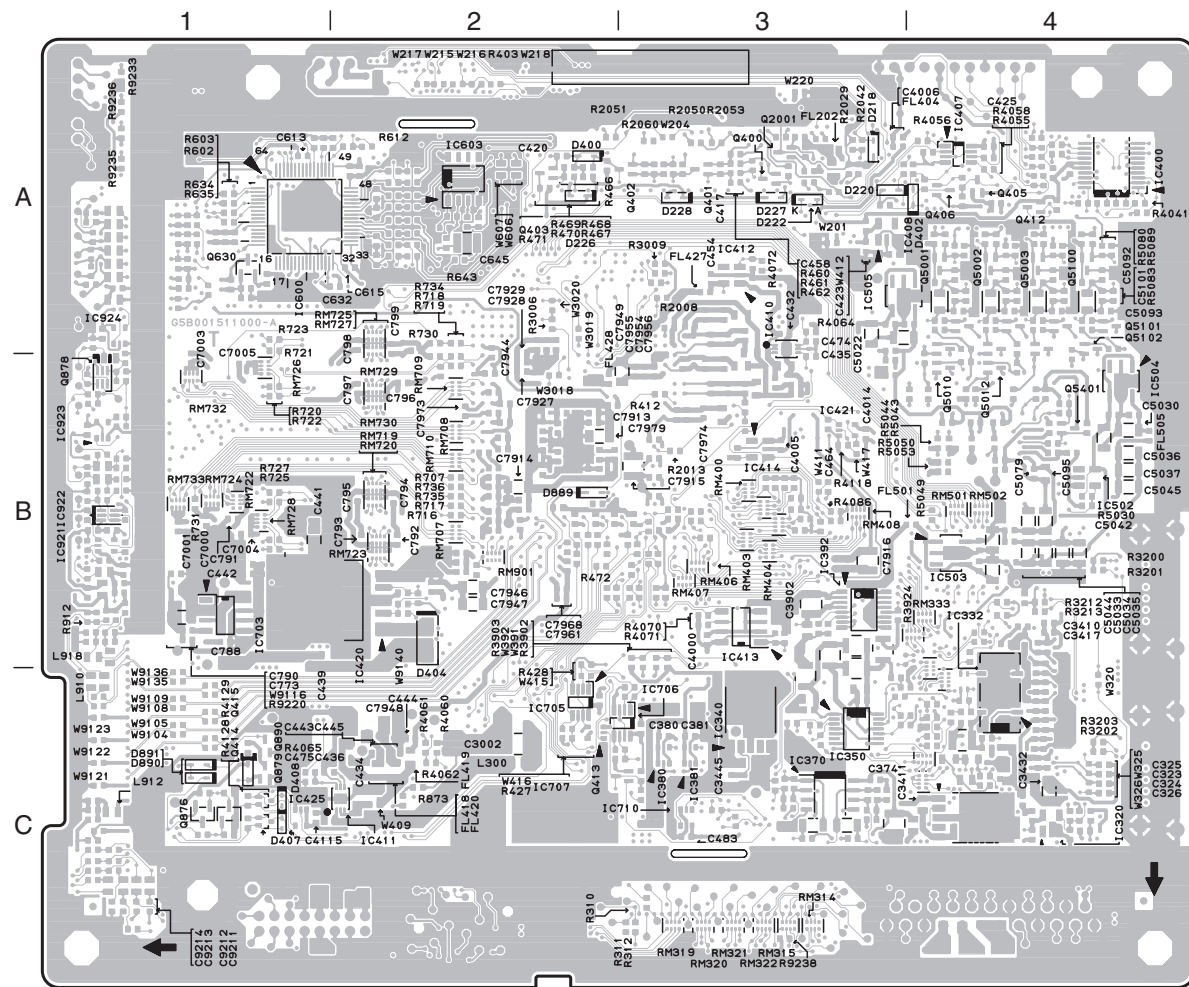

SIGNAL BOARD PD2238C1 (U001)
TOP (COMPONENT) SIDE

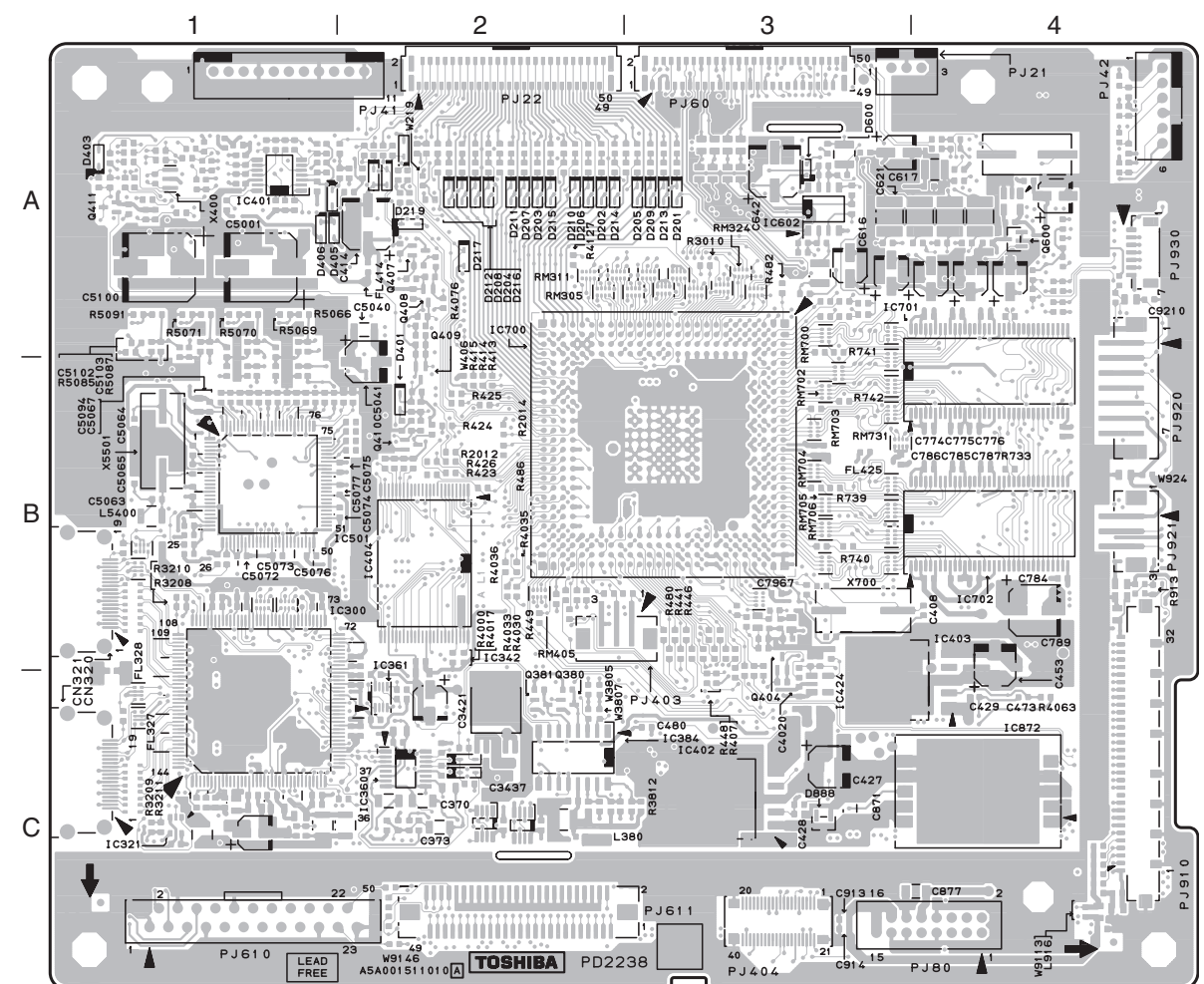



SCHEMATIC DIAGRAM

MODEL : 42WL55A/42WL55E/42WL55R/42WL55T

WARNING: BEFORE SERVICING THIS CHASSIS, READ THE "SERVICE SAFETY PRECAUTIONS" ON PAGE 3 OF THIS MANUAL.

CAUTION: The international hazard symbols " \triangle " in the schematic diagram and the parts list designate components which have special characteristics important for safety and should be replaced only with types identical to those in the original circuit or specified in the parts list. The mounting position of replacements is to be identical with originals. Before replacing any of these components, read carefully the PRODUCT SAFETY NOTICE on the MANUAL for this model. Do not degrade the safety of the receiver through improper servicing.

NOTE:

- RESISTOR** Resistance is shown in ohm [K = 1.000, M = 1.000.000]. All resistors are 1/6W and 5% tolerance carbon resistor, unless otherwise noted as the following marks.
1/2R = Metal or Metal oxide of 1/2 watt 1/2S = Carbon composition of 1/2 watt
1RF = Fuse resistor of 1 watt 10W = Cement of 10 watt
K = $\pm 10\%$ G = $\pm 2\%$ F = $\pm 1\%$
- CAPACITOR** Unless otherwise noted in schematic, all capacitor values less than 1 are expressed in F, and the values more than 1 in pF.
All capacitors are ceramic 50V, unless otherwise noted as the following marks.
 Electrolytic capacitor  Mylar capacitor
- The parts indicated with " \triangle " have special characteristics, and should be replaced with identical parts only.
- Voltages read with DIGITAL MULTI-METER from point indicated to chassis ground, using a color bar signal with all controls at normal, line voltage at 220 volts.
- Waveforms are taken receiving color bar signal with enough sensitivity.
- Voltage reading shown are nominal values and may vary $\pm 20\%$ except H.V.

■ SCHEMATIC DIAGRAM STRUCTURE:

AC INPUT Circuit		1/60
LOW_B Circuit	└── CONNECTOR	[SHEET-1/2] 2/60
	└── LOWB	[SHEET-2/2] 3/60
PC-IN Circuit		4/60
POWER Circuit	└── CONNECTOR	[SHEET-1/7] 5/60
	└── RELAY/RUSH PROTECTION	[SHEET-2/7] 6/60
	└── PFC	[SHEET-3/7] 7/60
	└── STANDBY POWER	[SHEET-4/7] 8/60
	└── RCC POWER	[SHEET-5/7] 9/60
	└── RESONANCE POWER	[SHEET-6/7] 10/60
	└── PROTECT/ AC DETECT	[SHEET-7/7] 11/60
LED RMT Circuit		12/60
TN_AV Circuit	└── CONNECTOR	[SHEET-1/6] 13/60
	└── AV-JACK	[SHEET-2/6] 14/60
	└── TIF	[SHEET-3/6] 15/60
	└── A-OUT	[SHEET-4/6] 16/60
	└── TEXT SW	[SHEET-5/6] 17/60
	└── VIDEO CHROMA	[SHEET-6/6] 18/60
FRONT-AV Circuit		19/60
KEY Circuit		20/60
SIGNAL Circuit	└── ANALOG_IN	[SHEET-200] 21/60
	└── PIP VCD	[SHEET-206] 22/60
	└── REG/RESET	[SHEET-207] 23/60
	└── INPUT LPF	[SHEET-208] 24/60
	└── FUNCTION	[SHEET-209] 25/60
	└── D_IN_A	[SHEET-300] 26/60
	└── D_IN_B	[SHEET-301] 27/60
	└── HDMI (LINC, I2C)	[SHEET-302] 28/60
	└── HDMI Rx#2 (Video/Audio)	[SHEET-303] 29/60
	└── HDMI Rx#3 (PWR,Audio)	[SHEET-304] 30/60
	└── HDMI AUDIO PLL	[SHEET-305] 31/60
	└── HDMI AUDIO DAC	[SHEET-306] 32/60
	└── HDMI AUDIO OUT	[SHEET-307] 33/60
	└── HDMI CONTROLLER	[SHEET-308] 34/60
	└── EEPROM1	[SHEET-309] 35/60
	└── EEPROM2	[SHEET-310] 36/60
	└── MICRO I/O	[SHEET-400] 37/60
	└── OCM MEMORY I/F	[SHEET-401] 38/60
	└── FLASH MEMORY	[SHEET-402] 39/60
	└── SYNC SEPA	[SHEET-403] 40/60
	└── E2P OTHER	[SHEET-404] 41/60
	└── STD-BY MICRO	[SHEET-405] 42/60
	└── CORTEZ REG 1	[SHEET-406] 43/60
	└── CORTEZ REG 2	[SHEET-407] 44/60
	└── CORTEZ REG 3	[SHEET-408] 45/60
	└── BOOT CONFIG	[SHEET-409] 46/60
	└── SERVICE CONNECTOR	[SHEET-410] 47/60
	└── I2C Switch	[SHEET-411] 48/60
	└── AUDIO (1/2)	[SHEET-600] 49/60
	└── AUDIO (2/2)	[SHEET-601] 50/60
	└── CORTEZ 1	[SHEET-700] 51/60
	└── CORTEZ 2	[SHEET-701] 52/60
	└── DDR I/F	[SHEET-702] 53/60
	└── DDR SDRAM	[SHEET-703] 54/60
	└── DDR TERMINATION	[SHEET-704] 55/60
	└── DCDC CONV.	[SHEET-802] 56/60
	└── LVDS OUT	[SHEET-900] 57/60
	└── LVDS OUT(SHARP LCD)	[SHEET-901] 58/60
	└── Power Connector and Dimming	[SHEET-902] 59/60
	└── LVDS Power and Others	[SHEET-903] 60/60

CIRCUIT BLOCK DIAGRAM

TN-AV UNIT

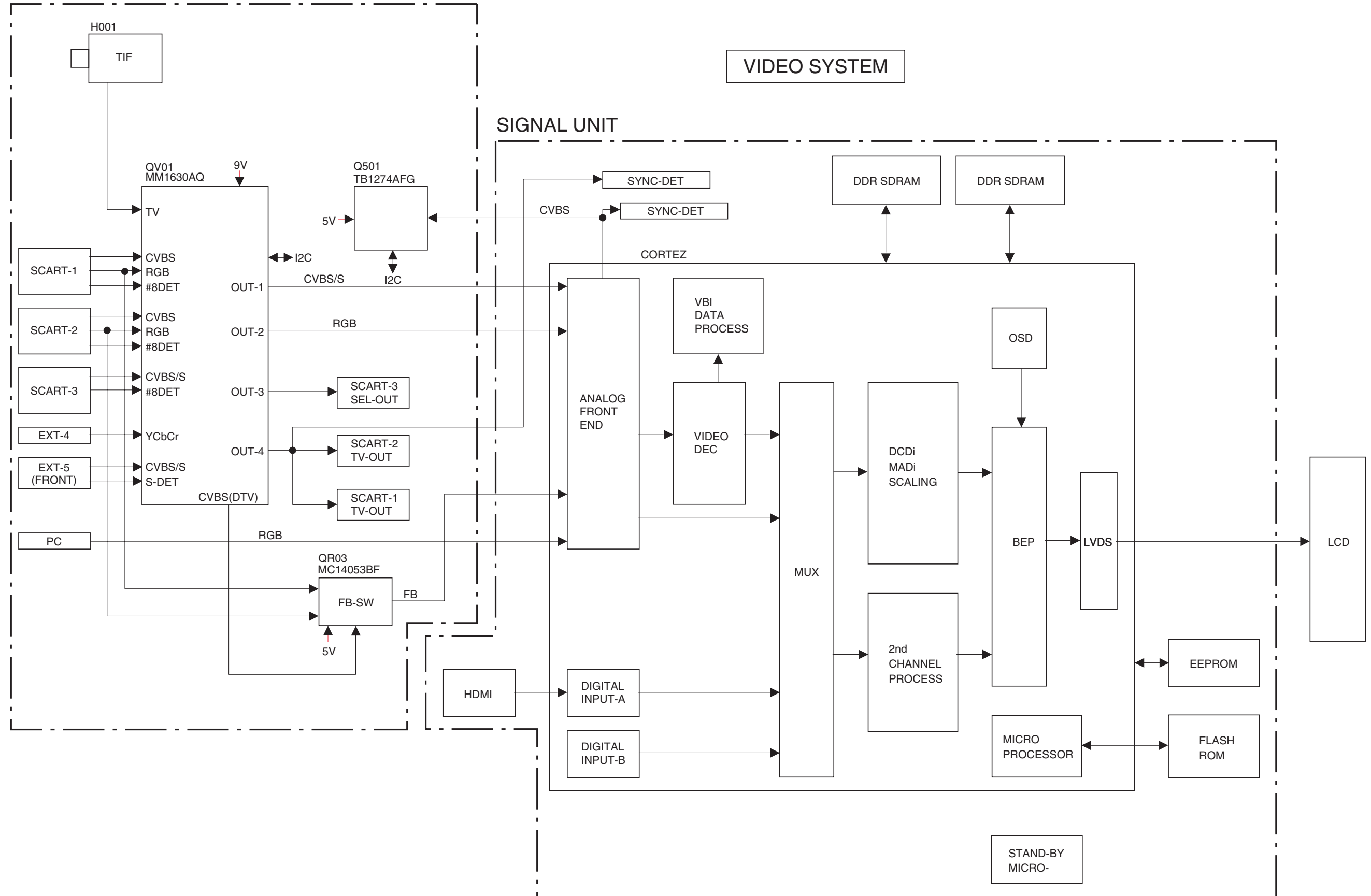

AUDIO SYSTEM

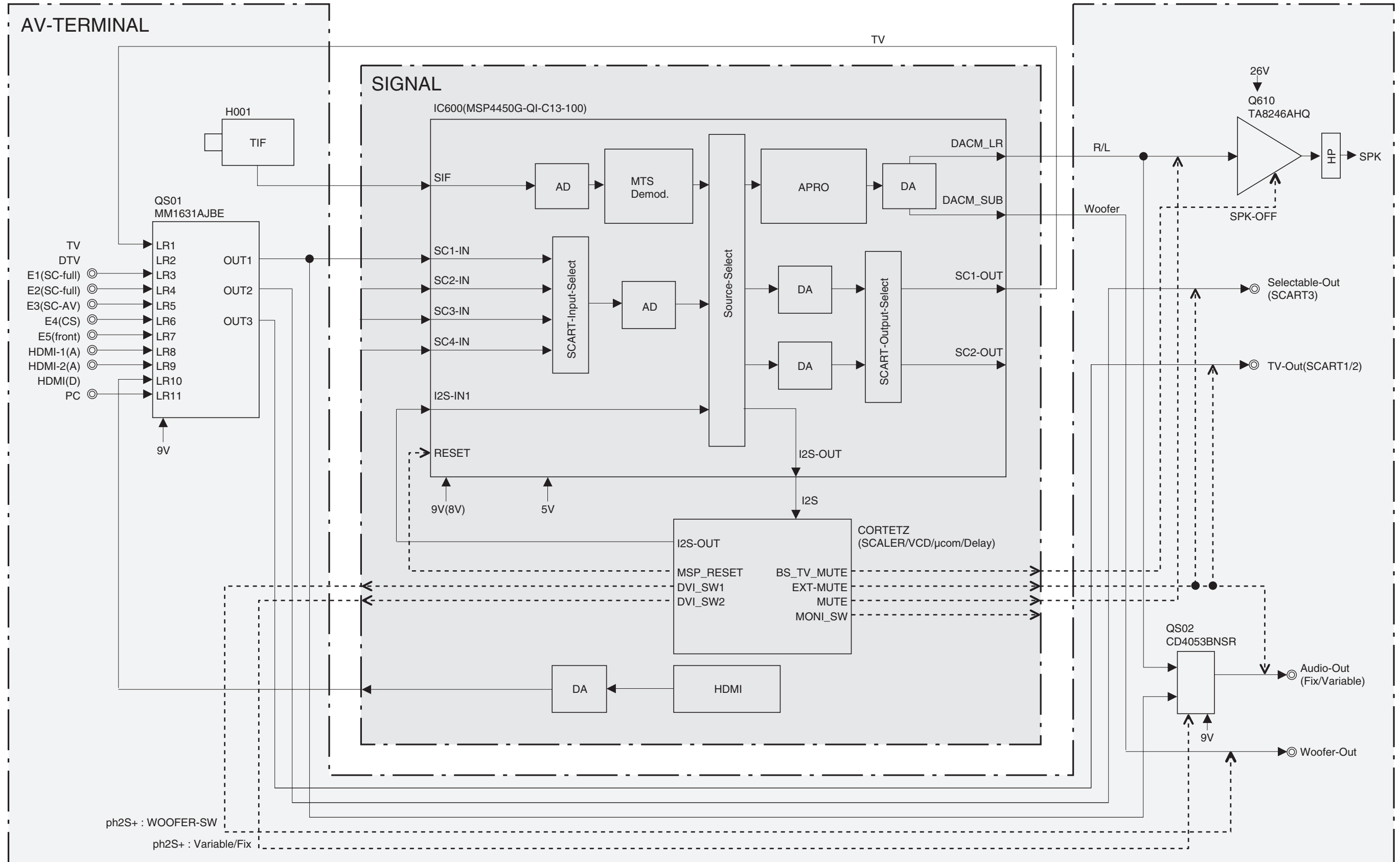

SPECIFICATIONS

Model	42WL55A, 42WL55E, 42WL55R, 42WL55T		
Power source	42WL55A/R	220V - 240V AC, 50 Hz	
	42WL55E	220V - 240V AC, 50/60 Hz	
	42WL55T	110V - 240V AC, 50/60 Hz	
Power consumption	240 W, 0.5 W (standby)		
Dimensions	1,044 mm (W)	757 mm (H)	352 mm (D)
Mass (Weight)	37.4 kg		
Television system (Antenna input)	Channel coverage:		
	PAL	B/G (CCIR)	VHF 2 - 12 UHF 21 - 69 CATV X - Z+2, S1 - S41
	PAL	I (UK)	VHF - UHF 21 - 69 CATV -
	PAL	D/K (CHINA)	VHF 1 - 12 UHF 13 - 57 CATV Z1 - Z38
	SECAM	B/G (CCIR)	VHF 2 - 12 UHF 21 - 69 CATV X - Z+2, S1 - S41
	SECAM	D/K (OIRT)	VHF 1 - 12 UHF 21 - 69 CATV X1 - X19
	NTSC	M (US)	VHF 2 - 13 UHF 14 - 69 CATV A6 - A1, A - W, AA - ZZ, AAA, BBB
	NTSC	M (JAPAN)	VHF 1 - 12 UHF 13 - 62 CATV M1 - M10, S1 - S41
	Special RF signal:		
	NTSC 4.43 color system 5.5/6.0/6.5 MHz sound system		
	PAL 60 Hz color system 5.5/6.0/6.5 MHz sound system		
COMPONENT VIDEO INPUT terminals (the signal format)	480i, 480p, 576i, 576p, 720p (50/60 Hz), 1080i (50/60 Hz) (These signal formats are converted to match the number of pixels of the LCD panel.)		
Color system	PAL, SECAM, NTSC 3.58/4.43		
Aspect ratio	16 : 9		
Visible size (diagonal)	106.7 cm		
Number of pixels	1366 (H) dots × 768 (V) dots		
Audio power	10 W + 10 W (10% THD)		
Speakers	Main: 60 × 120 mm 4pcs. Tweeter: 33 mm (round) 2pcs.		
Input/Output terminals	⊖ (1) Input	Component video	Y, P _B /C _B , P _R /C _R
		or Phono jacks	A/V
	⊖ (2) Input	Phono jacks	A/V
	⊖ (3) Input	Component video	Y, P _B /C _B , P _R /C _R
		Phono jacks	Audio L/Mono +R
	↻ MONITOR Output	Phono jacks	A/V
	↻ RGB/PC Input	Mini D-sub 15 pin	Analog RGB
	↻ Audio Input	3.5 mm stereo mini jack	
	Headphone jack	3.5 mm (Diameter) stereo	
Operating condition	Temperature	0°C - 35°C	
	Humidity	20% - 80% (No moisture condensation)	
Supplied accessories	Owner's manual (1), Remote control (1), Batteries (2), Clip (1)		



This is used to fix the TV to a wall, pillar, etc.

- Design and specifications are subject to change without notice.

TOSHIBA CORPORATION
1-1, SHIBAURA 1-CHOME, MINATO-KU, TOKYO 105-8001, JAPAN