

LOADING PATTERN MATING SIDE

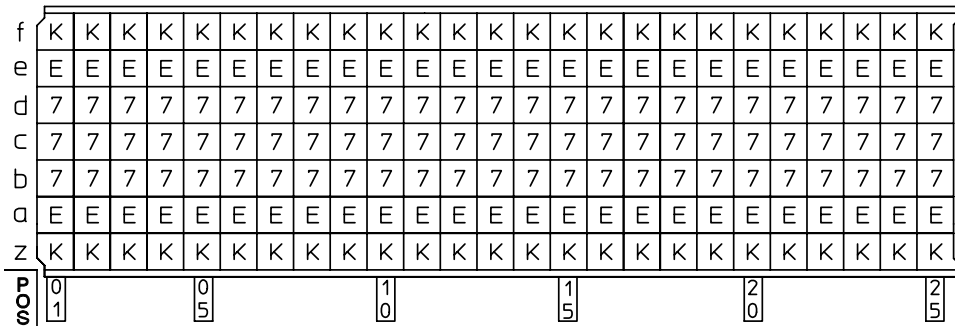

SHEET NR. : 699

LOADED CONNECTOR ASSEMBLY
(FOR EXAMPLE)

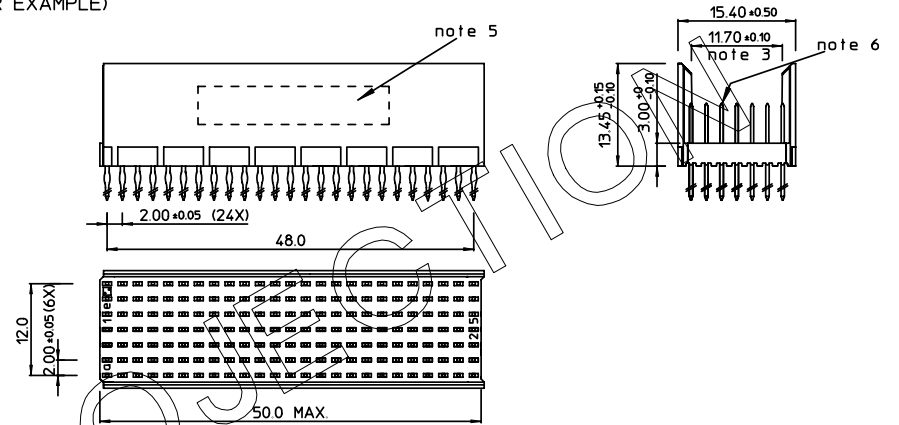

CONTACT OVERVIEW

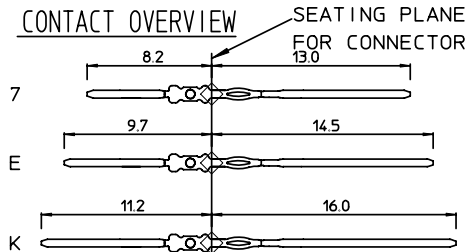

LAY-OUT P.C.B.-HOLE

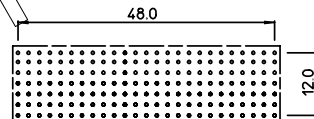

LEAD FREE INDICATOR : LF = LEAD FREE
(DIGIT 15 & 16)

HM2P08PMA214

PLATING CODE (DIGIT 13 AND 14)
(REF DWG No. BS,C ,201844,003)

NOTES:

- THIS PRODUCT IS CSA APPROVED.
- THIS PRODUCT IS UL RECOGNIZED.
- MEASURED AT THE BOTTOM.
- MATERIAL CONTACT: PHOSPHORBRONZE
HOUSING: CREAM WHITE GLASSFILLED POLYESTER UL-94V0
- CONNECTOR PRINTED WITH P/N AND DATE CODE.
- FOR ACTUAL CONTACT LOADINGS, SEE LOADING PATTERN MATING SIDE.
- SHAPE OF CONNECTOR HOUSING CAN ALTER DEPENDING ON PRODUCTION LOCATION.
- THE PRODUCT (LF) MEETS EUROPEAN UNION DIRECTIVES AND OTHER COUNTRY REGULATIONS AS DESCRIBED IN GS-22-008
- FOR RECOMMENDED PTH DIMENSIONS REFER DRAWING : BS,A ,201572,001

EUROPEAN PRO

1DEC ±0,2 2DEC ±0,1 ANGLES ±1°	APPR.	DATE	SIGN.	LOADING PATTERN OVERVIEW
	DRAFT	1998-08-06	M.Frel	CAT. No. HM2P08PMA214----
WE RESERVE THE RIGHT TO CHANGE DIMENSIONS OR REQUIREMENTS WITHOUT PRIOR NOTICE.	CHECKED			SCALE
	PROD. MGR			
ALL DIMENSIONS IN MM	PR. ENG MGR			www.fciconnect.com
	PR. MGT MGR			
REFERENCES				BS,C ,201843,600
DRAWING No.				D
CUSTOMER DRAWING				REVISION

THIS IS OUR EXCLUSIVE PROPERTY. IT IS NOT TO BE COPIED, REPRINTED OR DISCLOSED TO A THIRD PARTY, NOR USED FOR MANUFACTURING WITHOUT OUR WRITTEN CONSENT. AND HAS TO BE RETURNED TO US IN CASE OF NO USAGE

DIT IS ONZE EIGENDOM EN MAG NIET HEGEMAAKT, HERDRUKT, OVERGEHAAKT AAN DEREN, NOCH VOOR FABRICATIE GEBRUIKT WORDEN, ZONDER ONZE SCHRIFTELIJKE TOELATING. BIJ NIET GEBRUIK IS TERUGZENDING VERPLICHT.

GEN. ST.	01	02	03	04	05	06	07	08	0D	50	60	70	80	90																	
INT. ST.	10	11	12	13	14	18	20	31	32	33	34	38	39	40	42	43	44	45	46	48	56	70	72	73	75	76	81	82	83	84	88

REV.	DATE	DESCRIPTION	BY	C'K'D'
D	2005-06-01	105-0083	ALEX B	BKP
E	2006-08-03	106-0119	ALEX B	BKP
F	2007-04-11	107-0049	ALEX B	BKP
G	2007-05-17	107-0058	ALEX B	BKP

MILLIPACS : CONTACT PLATING CODE OVERVIEW

HM2---P------(L-)(LF)

FOR LEAD FREE PLATING
OPTIONAL (NOTE 1)
PLATING CODE (DIGIT 13 AND 14)

PLATING CODE	DESCRIPTION	PERFORMANCE
L9	MALE CONN.: SHORT / WIRE WRAP CONT. FEMALE CONNECTOR	TELCORDIA UE
E9	MALE CONN.: SHORT / WIRE WRAP CONT. FEMALE CONNECTOR	PERFORMANCE LEVEL 1 (500 mating cycles)
N9	MALE CONN.: SHORT / WIRE WRAP CONT. FEMALE CONNECTOR	PERFORMANCE LEVEL 2 (250 mating cycles)/ TELCORDIA CO
Z1	MALE CONN.: SHORT / WIRE WRAP CONT. FEMALE CONNECTOR	PERFORMANCE LEVEL 3 (50 mating cycles)
GE	MALE CONN.: REAR PLUG-UP CONTACTS	TELCORDIA UE
GL	MALE CONN.: REAR PLUG-UP CONTACTS	PERFORMANCE LEVEL 1 (500 mating cycles)
GF	MALE CONN.: REAR PLUG-UP CONTACTS	PERFORMANCE LEVEL 2 (250 mating cycles)/ TELCORDIA CO
GC	MALE CONN.: REAR PLUG-UP CONTACTS	PERFORMANCE LEVEL 3 (50 mating cycles)

NOTE :

- 1) IN CASE OF STR HDR CONNECTORS :
EXTENSIONS CAN BE ADDED TO THE PLATING CODE
IF LUBRICATED CONTACTS ARE REQUIRED
L : LUBRICATED
L1: LUBRICATED TO MEET TELCORDIA GR-1217 CORE REQUIREMENTS
- 2) PLATING AT EON AREA
LF : Sn MATT FINISH PLATING
ALL OTHER PART NOS : SnPb PLATING
- 3) FOR PRODUCT SPEC. REFER GS-12-203

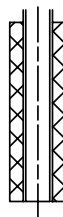

REF NOTE 2 FOR EON PLATING

1DEC ±0,2 2DEC ±0,1 ANGLES ±1°	APPR.	DATE	SIGN.	MPACS CONTACT PLATING OVERVIEW	
	DRAFT	2003-03-21	M.Fret	CAT. No. HM2---P------(L-)	
	CHECKED			 www.fciconnect.com	
WE RESERVE THE RIGHT TO CHANGE DIMENSIONS OR REQUIREMENTS WITHOUT PRIOR NOTICE.	PROD. MGR.				SCALE
	PR. ENG. MGR.				
ALL DIMENSIONS IN MM	PR. MGT. MGR.				

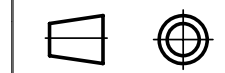

REFERENCES

BS,C ,201844,003 G