

GENERAL DESCRIPTION

This N-Channel enhancement mode field effect transistor is produced using high cell density, DMOS technology. These products have been designed to minimize on-state resistance while provide rugged, reliable, and fast switching and ESD enhanced performance. It can be used in most applications requiring up to 115mA DC and can deliver pulsed currents up to 800mA. This product is particularly suited for low voltage, low current applications such as small servo motor control, power MOSFET gate drivers, and other switching applications.

FEATURES

- ◆ High Density Cell Design for Low $R_{DS(ON)}$
- ◆ Voltage Controlled Small Signal Switch
- ◆ Rugged and Reliable
- ◆ High Saturation Current Capability
- ◆ ESD Protected 2KV HBM

PIN CONFIGURATION

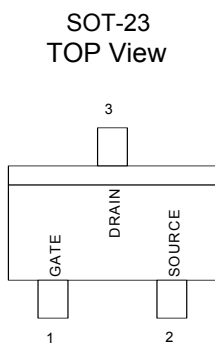

SYMBOL

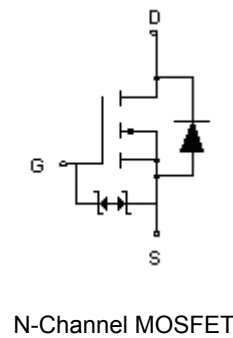

ORDERING INFORMATION

Part Number	Package
CMT2N7002K	SOT-23
CMT2N7002KX*	SOT-23

***Note:** X : Suffix for Halogen Free Product

ABSOLUTE MAXIMUM RATINGS

Rating	Symbol	Value	Unit
Drain Source Voltage	V_{DSS}	60	V
Drain-Gate Voltage ($R_{GS} = 1.0M\Omega$)	V_{DGR}	60	V
Drain to Current – Continuous	I_D	115	mA
– Pulsed	I_{DM}	800	
Gate-to-Source Voltage – Continue	V_{GS}	± 15	V
– Non-repetitive	V_{GSM}	± 15	V
Total Power Dissipation	P_D	225	mW
Derate above 25°C		1.8	mW/°C
Operating and Storage Temperature Range	T_J, T_{STG}	-55 to 150	°C
Thermal Resistance – Junction to Ambient	θ_{JA}	417	°C/W
Maximum Lead Temperature for Soldering Purposes, 1/8" from case for 10 seconds	T_L	300	°C

ELECTRICAL CHARACTERISTICS

Unless otherwise specified, $T_J = 25^\circ\text{C}$.

Characteristic	Symbol	CMT2N7002K			Units
		Min	Typ	Max	
Drain-Source Breakdown Voltage ($V_{GS} = 0\text{ V}$, $I_D = 10\ \mu\text{A}$)	$V_{(BR)DSS}$		60		V
Drain-Source Leakage Current ($V_{DS} = 60\text{ V}$, $V_{GS} = 0\text{ V}$) ($V_{DS} = 60\text{ V}$, $V_{GS} = 0\text{ V}$, $T_J = 125^\circ\text{C}$)	I_{DSS}			1.0 0.5	μA mA
Gate-Source Leakage Current-Forward ($V_{gsf} = 15\text{ V}$)	I_{GSSF}			1.0	μA
Gate-Source Leakage Current-Reverse ($V_{gsf} = -15\text{ V}$)	I_{GSSF}			-1.0	μA
Gate Threshold Voltage * ($V_{DS} = V_{GS}$, $I_D = 250\ \mu\text{A}$)	$V_{GS(th)}$		1.0	2.5	V
On-State Drain Current ($V_{DS} \geq 2.0 V_{DS(on)}$, $V_{GS} = 10\text{V}$)	$I_{d(on)}$		500		mA
Static Drain-Source On-Resistance * ($V_{GS} = 10\text{ V}$, $I_D = 0.5\text{A}$) ($V_{GS} = 10\text{ V}$, $I_D = 0.5\text{A}$, $T_J = 125^\circ\text{C}$) ($V_{GS} = 5.0\text{ V}$, $I_D = 50\text{mA}$) ($V_{GS} = 5.0\text{ V}$, $I_D = 50\text{mA}$, $T_J = 125^\circ\text{C}$)	$R_{DS(on)}$			7.5 13.5 7.5 13.5	Ω
Drain-Source On-Voltage * ($V_{GS} = 10\text{ V}$, $I_D = 0.5\text{A}$) ($V_{GS} = 5.0\text{ V}$, $I_D = 50\text{mA}$)	$V_{DS(on)}$			3.75 0.375	V
Forward Transconductance ($V_{DS} \geq 2.0 V_{DS(on)}$, $I_D = 200\text{mA}$) *	g_{FS}		80		mmhos
Input Capacitance	($V_{DS} = 25\text{ V}$, $V_{GS} = 0\text{ V}$, $f = 1.0\text{ MHz}$)	C_{iss}		50	pF
Output Capacitance		C_{oss}		25	pF
Reverse Transfer Capacitance		C_{rss}		5.0	pF
Turn-On Delay Time	($V_{DD} = 25\text{ V}$, $I_D = 500\text{ mA}$, $V_{gen} = 10\text{ V}$, $R_G = 25\Omega$, $R_L = 50\Omega$) *	$t_{d(on)}$		20	ns
Turn-Off Delay Time		$t_{d(off)}$		40	ns
Diode Forward On-Voltage ($I_S = 115\text{ mA}$, $V_{GS} = 0\text{V}$)	V_{SD}			-1.5	V
Source Current Continuous (Body Diode)	I_S			-115	mA
Source Current Pulsed	I_{SM}			-800	mA

* Pulse Test: Pulse Width $\leq 300\mu\text{s}$, Duty Cycle $\leq 2\%$

TYPICAL ELECTRICAL CHARACTERISTICS

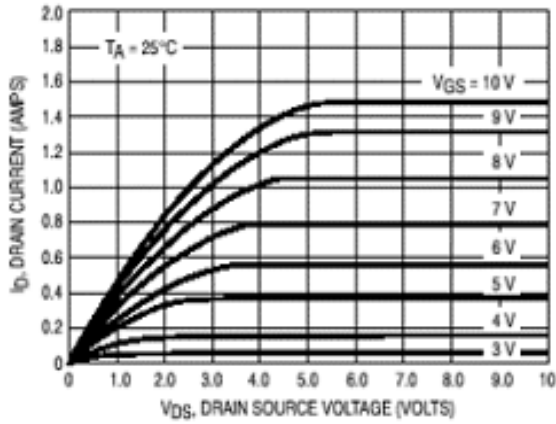

Figure 1. Ohmic Region

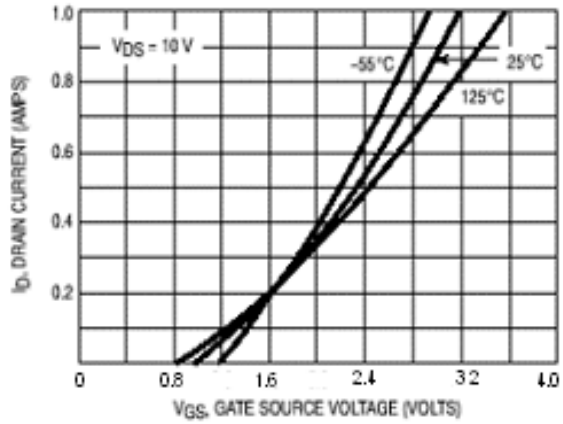

Figure 2. Transfer Characteristics

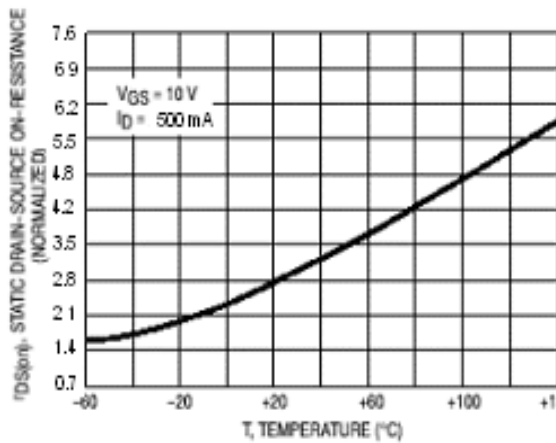

Figure 3. Temperature versus Static Drain-Source On-Resistance

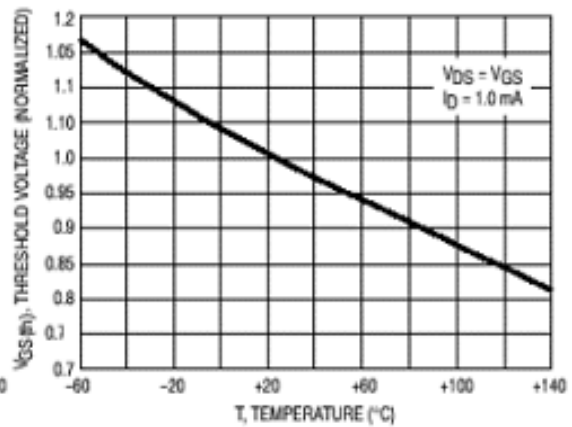

Figure 4. Temperature versus Gate Threshold Voltage

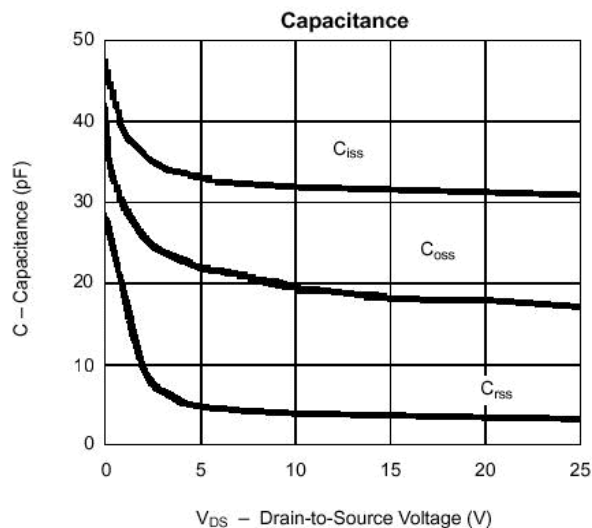
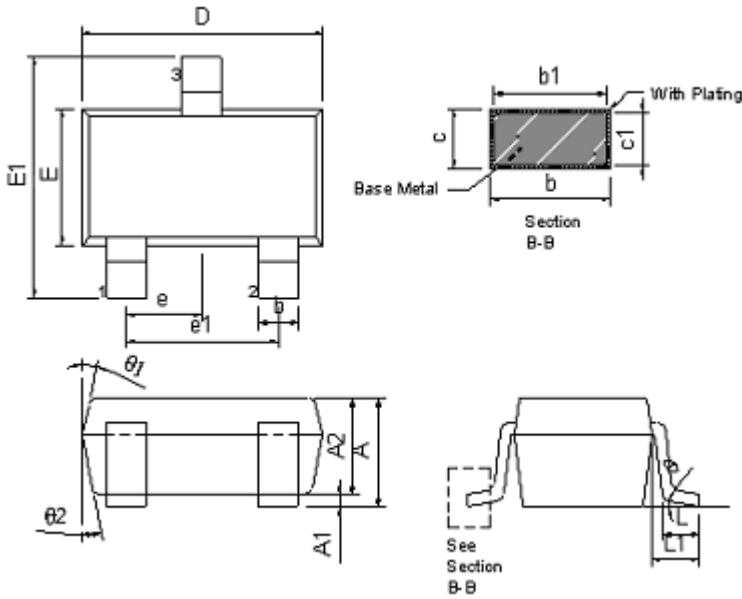

Figure 5. Capacitance

PACKAGE DIMENSION

SOT-23



Symbol	Dimensions in Millimeters		Dimensions in Inches	
	Min	Max	Min	Max
A	0.900	1.200	0.035	0.043
A1	0.000	0.100	0.000	0.004
A2	0.900	1.100	0.035	0.039
b	0.300	0.500	0.012	0.020
c	0.080	0.150	0.003	0.006
D	2.800	3.000	0.110	0.118
E	1.200	1.400	0.047	0.055
E1	2.250	2.550	0.089	0.100
e	0.950 TYP		0.037 TYP	
e1	1.800	2.000	0.071	0.079
L	0.550 REF		0.022 REF	
L1	0.300	0.500	0.012	0.020
θ	0°	8°	0°	6°

IMPORTANT NOTICE

Champion Microelectronic Corporation (CMC) reserves the right to make changes to its products or to discontinue any integrated circuit product or service without notice, and advises its customers to obtain the latest version of relevant information to verify, before placing orders, that the information being relied on is current.

A few applications using integrated circuit products may involve potential risks of death, personal injury, or severe property or environmental damage. CMC integrated circuit products are not designed, intended, authorized, or warranted to be suitable for use in life-support applications, devices or systems or other critical applications. Use of CMC products in such applications is understood to be fully at the risk of the customer. In order to minimize risks associated with the customer's applications, the customer should provide adequate design and operating safeguards.

HsinChu Headquarter

5F, No. 11, Park Avenue II,
Science-Based Industrial Park,
HsinChu City, Taiwan
TEL: +886-3-567 9979
FAX: +886-3-567 9909

Sales & Marketing

21F., No. 96, Sec. 1, Sintai 5th Rd., Sijhih City,
Taipei County 22102,
Taiwan, R.O.C.
TEL: +886-2-2696 3558
FAX: +886-2-2696 3559
