

Schottky Rectifier, 2.1 A

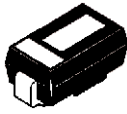

SMA

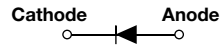

FEATURES

- Small foot print, surface mountable
- Low forward voltage drop
- High frequency operation
- Guard ring for enhanced ruggedness and long term reliability
- Meets MSL level 1, per J-STD-020, LF maximum peak of 260 °C
- Compliant to RoHS directive 2002/95/EC
- Designed and qualified for industrial level

RoHS
COMPLIANT

PRODUCT SUMMARY

$I_{F(AV)}$	2.1 A
V_R	100 V

DESCRIPTION

The VS-10MQ100NPbF surface mount Schottky rectifier has been designed for applications requiring low forward drop and very small foot prints on PC boards. Typical applications are in disk drives, switching power supplies, converters, freewheeling diodes, battery charging, and reverse battery protection.

MAJOR RATINGS AND CHARACTERISTICS

SYMBOL	CHARACTERISTICS	VALUES	UNITS
$I_{F(AV)}$	DC	2.1	A
V_{RRM}		100	V
I_{FSM}	$t_p = 5 \mu s$ sine	120	A
V_F	1.5 Apk, $T_J = 125 \text{ }^\circ\text{C}$	0.68	V
T_J	Range	- 55 to 150	$^\circ\text{C}$

VOLTAGE RATINGS

PARAMETER	SYMBOL	VS-10MQ100NPbF	UNITS
Maximum DC reverse voltage	V_R	100	V
Maximum working peak reverse voltage	V_{RWM}		

ABSOLUTE MAXIMUM RATINGS

PARAMETER	SYMBOL	TEST CONDITIONS	VALUES	UNITS
Maximum average forward current See fig. 4	$I_{F(AV)}$	50 % duty cycle at $T_L = 126 \text{ }^\circ\text{C}$, rectangular waveform On PC board 9 mm ² island (0.013 mm thick copper pad area)	1.5	A
Maximum peak one cycle non-repetitive surge current, $T_J = 25 \text{ }^\circ\text{C}$ See fig. 6	I_{FSM}	5 μs sine or 3 μs rect. pulse	120	A
		10 ms sine or 6 ms rect. pulse	30	
Non-repetitive avalanche energy	E_{AS}	$T_J = 25 \text{ }^\circ\text{C}$, $I_{AS} = 0.5 \text{ A}$, $L = 8 \text{ mH}$	1.0	mJ
Repetitive avalanche current	I_{AR}	Current decaying linearly to zero in 1 μs Frequency limited by T_J maximum $V_A = 1.5 \times V_R$ typical	0.5	A

ELECTRICAL SPECIFICATIONS					
PARAMETER	SYMBOL	TEST CONDITIONS		VALUES	UNITS
Maximum forward voltage drop See fig. 1	$V_{FM}^{(1)}$	1 A	$T_J = 25\text{ }^\circ\text{C}$	0.78	V
		1.5 A		0.85	
		1 A	$T_J = 125\text{ }^\circ\text{C}$	0.63	
		1.5 A		0.68	
Maximum reverse leakage current See fig. 2	$I_{RM}^{(1)}$	$T_J = 25\text{ }^\circ\text{C}$	$V_R = \text{Rated } V_R$	0.1	mA
		$T_J = 125\text{ }^\circ\text{C}$		1	
Threshold voltage	$V_{F(TO)}$	$T_J = T_J \text{ maximum}$		0.52	V
Forward slope resistance	r_t			78.4	m Ω
Typical junction capacitance	C_T	$V_R = 10\text{ }V_{DC}$, $T_J = 25\text{ }^\circ\text{C}$, test signal = 1 MHz		38	pF
Typical series inductance	L_S	Measured lead to lead 5 mm from package body		2.0	nH
Maximum voltage rate of change	dV/dt	Rated V_R		10 000	V/ μ s

Note

(1) Pulse width < 300 μ s, duty cycle < 2 %

THERMAL - MECHANICAL SPECIFICATIONS					
PARAMETER	SYMBOL	TEST CONDITIONS		VALUES	UNITS
Maximum junction and storage temperature range	$T_J^{(1)}$, T_{Stg}			- 55 to 150	$^\circ\text{C}$
Maximum thermal resistance, junction to ambient	R_{thJA}	DC operation		80	$^\circ\text{C/W}$
Approximate weight				0.07	g
				0.002	oz.
Marking device		Case style SMA (similar D-64)		V1J	

Note

(1) $\frac{dP_{tot}}{dT_J} < \frac{1}{R_{thJA}}$ thermal runaway condition for a diode on its own heatsink

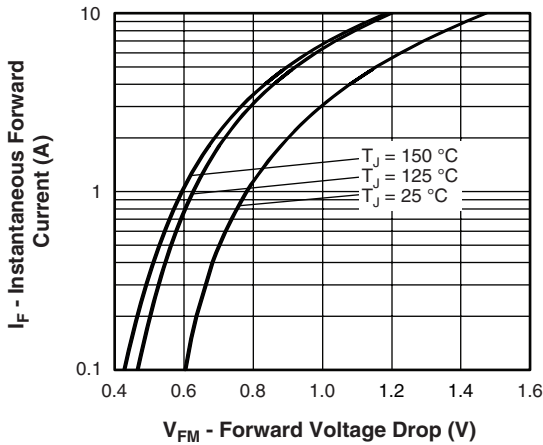

Fig. 1 - Maximum Forward Voltage Drop Characteristics

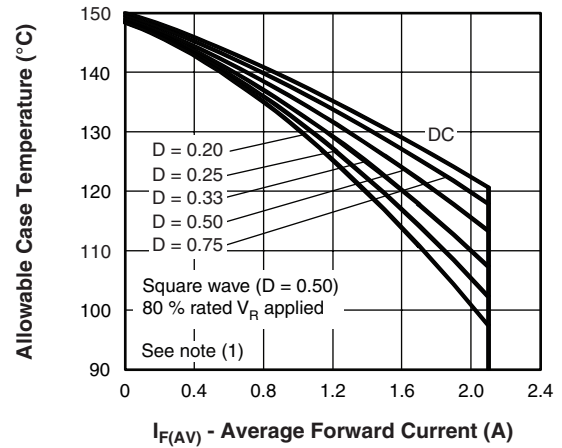

Fig. 4 - Maximum Average Forward Current vs. Allowable Lead Temperature

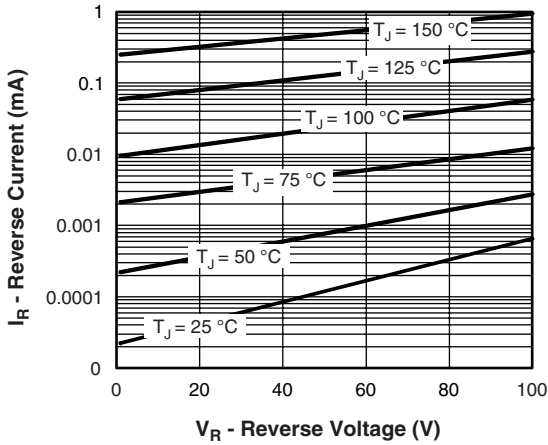

Fig. 2 - Typical Peak Reverse Current vs. Reverse Voltage

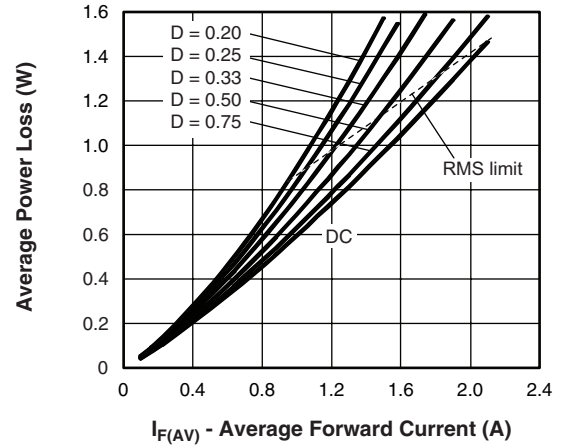

Fig. 5 - Maximum Average Forward Dissipation vs. Average Forward Current

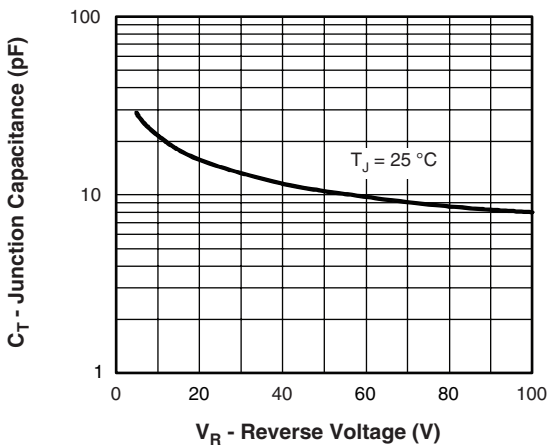

Fig. 3 - Typical Junction Capacitance vs. Reverse Voltage

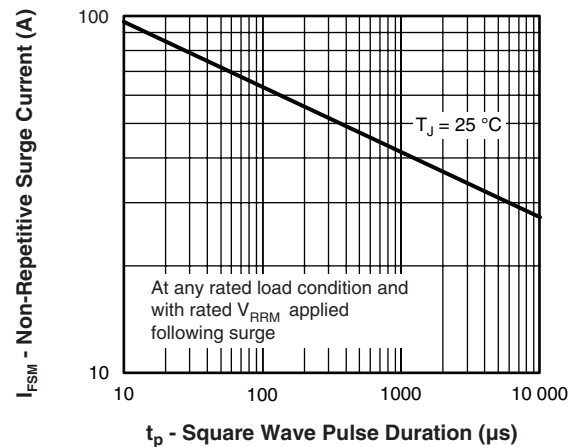

Fig. 6 - Maximum Peak Surge Forward Current vs. Pulse Duration

Note

(1) Formula used: $T_C = T_J - (Pd + Pd_{REV}) \times R_{thJC}$;

Pd = Forward power loss = $I_{F(AV)} \times V_{FM}$ at $(I_{F(AV)}/D)$ (see fig. 6); Pd_{REV} = Inverse power loss = $V_{R1} \times I_R (1 - D)$; I_R at $V_{R1} = 80\%$ rated V_R

VS-10MQ100NPbF



Vishay High Power Products Schottky Rectifier, 2.1 A

ORDERING INFORMATION TABLE

Device code	VS-	10	M	Q	100	N	TR	PbF
	①	②	③	④	⑤	⑥	⑦	⑧

- 1** - HPP product suffix
- 2** - Current rating
- 3** - M = SMA
- 4** - Q = Schottky "Q" series
- 5** - Voltage rating (100 = 100 V)
- 6** - N = New SMA
- 7** -
 - None = Box (1000 pieces)
 - TR = Tape and reel (7500 pieces)
- 8** - PbF = Lead (Pb)-free

LINKS TO RELATED DOCUMENTS	
Dimensions	www.vishay.com/doc?95018
Part marking information	www.vishay.com/doc?95029
Packaging information	Tape and reel www.vishay.com/doc?95034
	Bulk www.vishay.com/doc?95397
SPICE model	www.vishay.com/doc?95371

SMA

DIMENSIONS in millimeters (inches)

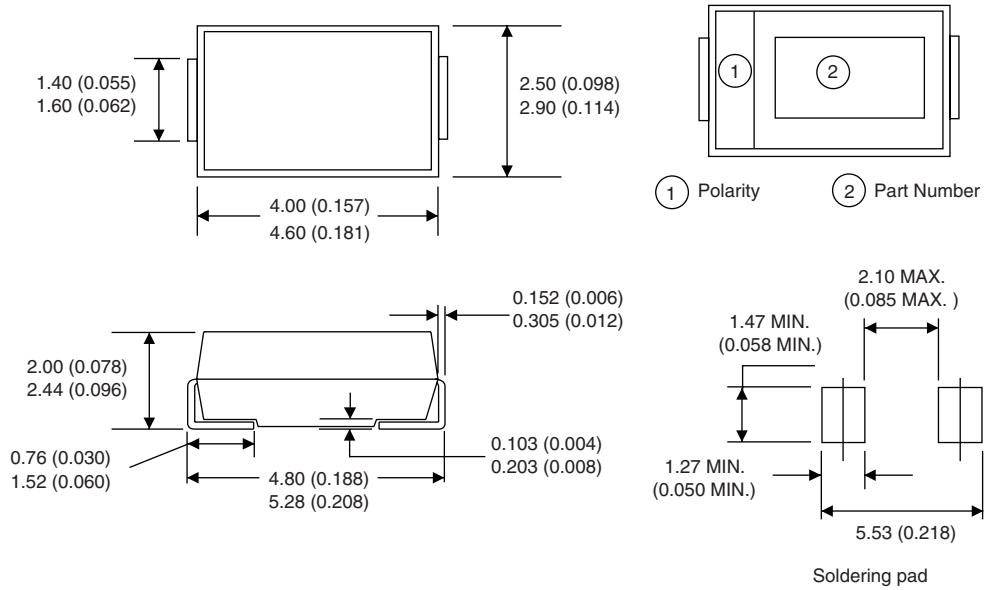



Disclaimer

ALL PRODUCT, PRODUCT SPECIFICATIONS AND DATA ARE SUBJECT TO CHANGE WITHOUT NOTICE TO IMPROVE RELIABILITY, FUNCTION OR DESIGN OR OTHERWISE.

Vishay Intertechnology, Inc., its affiliates, agents, and employees, and all persons acting on its or their behalf (collectively, "Vishay"), disclaim any and all liability for any errors, inaccuracies or incompleteness contained in any datasheet or in any other disclosure relating to any product.

Vishay makes no warranty, representation or guarantee regarding the suitability of the products for any particular purpose or the continuing production of any product. To the maximum extent permitted by applicable law, Vishay disclaims (i) any and all liability arising out of the application or use of any product, (ii) any and all liability, including without limitation special, consequential or incidental damages, and (iii) any and all implied warranties, including warranties of fitness for particular purpose, non-infringement and merchantability.

Statements regarding the suitability of products for certain types of applications are based on Vishay's knowledge of typical requirements that are often placed on Vishay products in generic applications. Such statements are not binding statements about the suitability of products for a particular application. It is the customer's responsibility to validate that a particular product with the properties described in the product specification is suitable for use in a particular application. Parameters provided in datasheets and/or specifications may vary in different applications and performance may vary over time. All operating parameters, including typical parameters, must be validated for each customer application by the customer's technical experts. Product specifications do not expand or otherwise modify Vishay's terms and conditions of purchase, including but not limited to the warranty expressed therein.

Except as expressly indicated in writing, Vishay products are not designed for use in medical, life-saving, or life-sustaining applications or for any other application in which the failure of the Vishay product could result in personal injury or death. Customers using or selling Vishay products not expressly indicated for use in such applications do so at their own risk. Please contact authorized Vishay personnel to obtain written terms and conditions regarding products designed for such applications.

No license, express or implied, by estoppel or otherwise, to any intellectual property rights is granted by this document or by any conduct of Vishay. Product names and markings noted herein may be trademarks of their respective owners.

Material Category Policy

Vishay Intertechnology, Inc. hereby certifies that all its products that are identified as RoHS-Compliant fulfill the definitions and restrictions defined under Directive 2011/65/EU of The European Parliament and of the Council of June 8, 2011 on the restriction of the use of certain hazardous substances in electrical and electronic equipment (EEE) - recast, unless otherwise specified as non-compliant.

Please note that some Vishay documentation may still make reference to RoHS Directive 2002/95/EC. We confirm that all the products identified as being compliant to Directive 2002/95/EC conform to Directive 2011/65/EU.

Vishay Intertechnology, Inc. hereby certifies that all its products that are identified as Halogen-Free follow Halogen-Free requirements as per JEDEC JS709A standards. Please note that some Vishay documentation may still make reference to the IEC 61249-2-21 definition. We confirm that all the products identified as being compliant to IEC 61249-2-21 conform to JEDEC JS709A standards.