

Anforderungsstufe 1  
Performance Level 1

Kontaktbereich vergoldet  
Mating Area gold plating

Anschlussbereich verzinkt 4-6 µm  
Terminal Area 4-6 µm tin plating

Koplanarität der Anschlüsse ≤ 0,1 mm  
Coplanarity Area of Termination ≤ 0,1 mm

Verpackt in Gurtverpackung  
Tape on Reel Packaging  
Verpackungseinheit: 280 Stück  
Packaging unit: 280 pcs

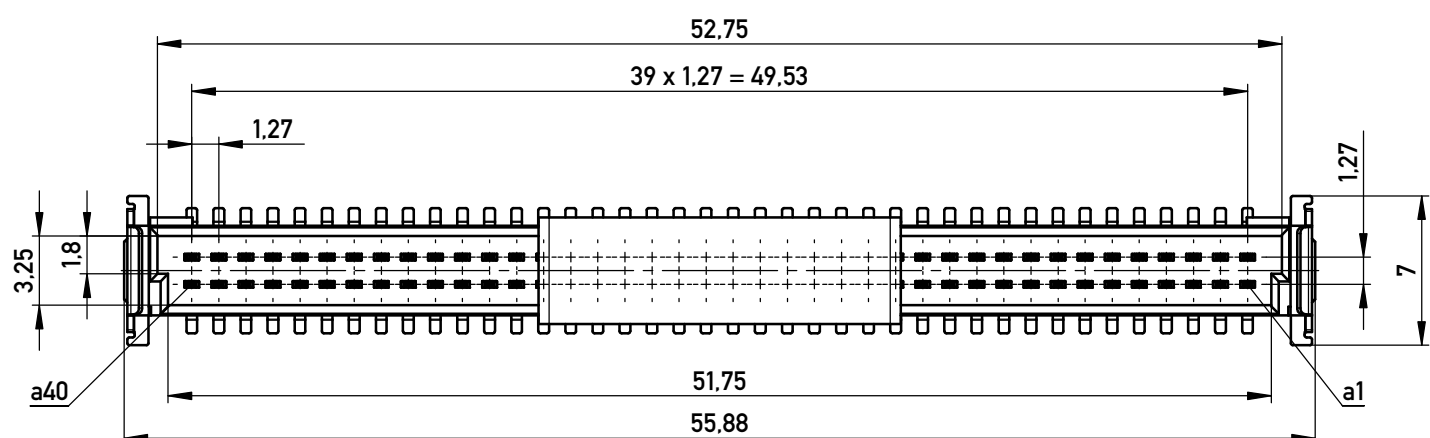
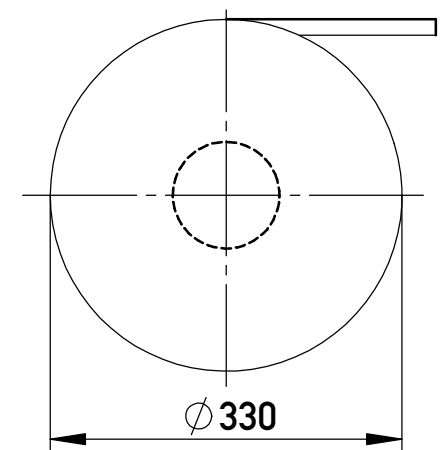

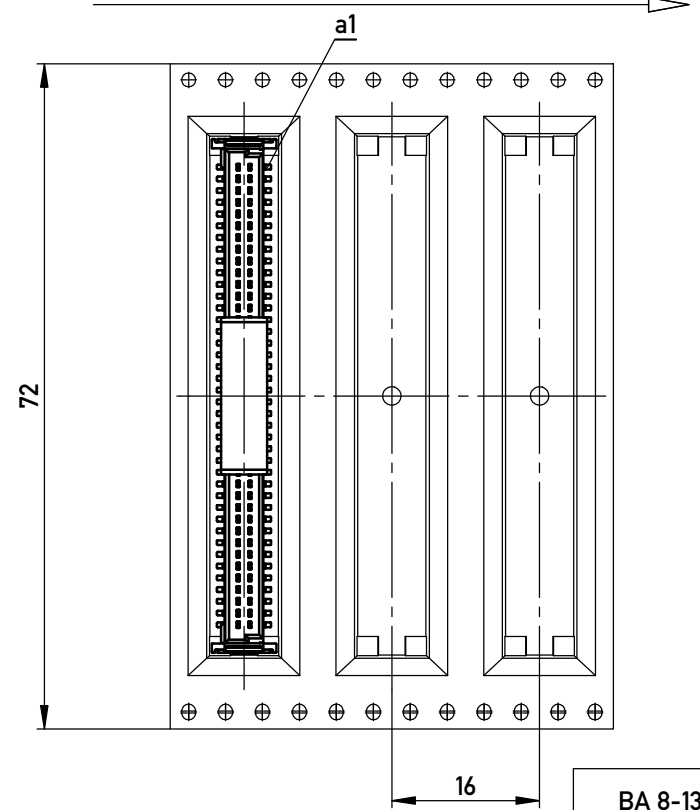
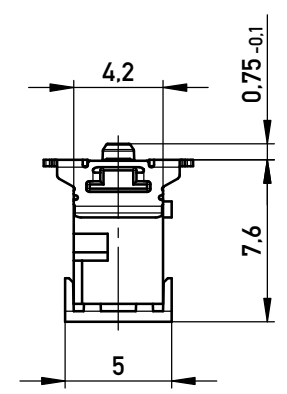
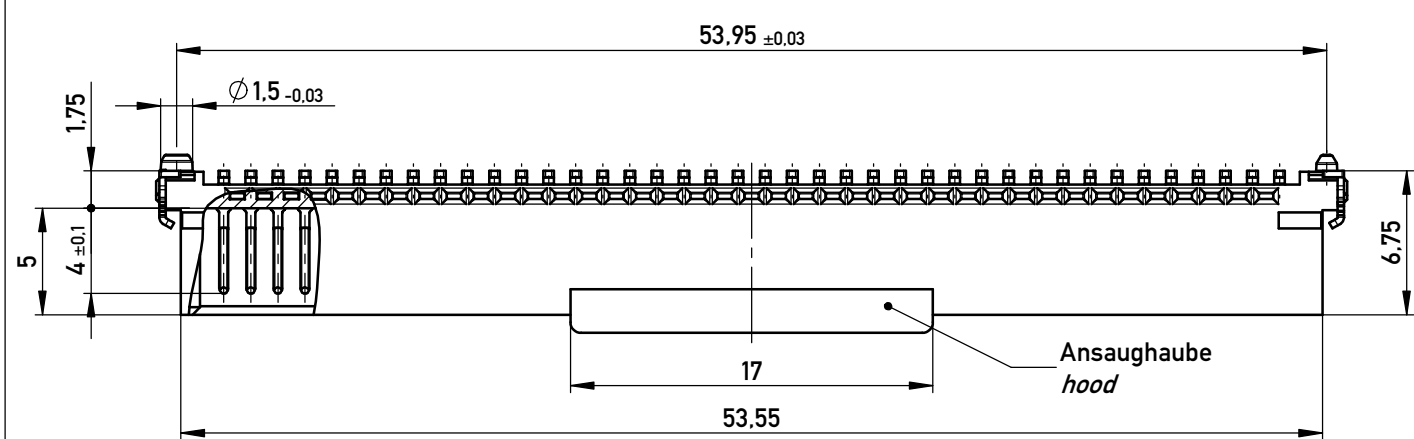

Abspulrichtung - Reel off Direction

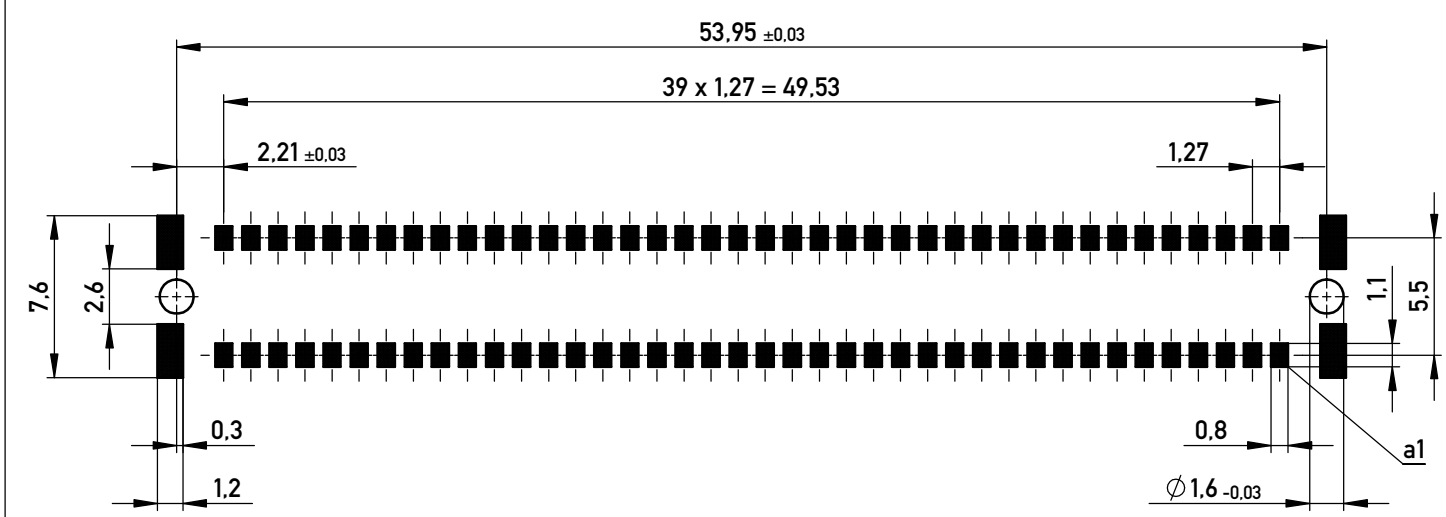

Leiterplatten-Layout Vorschlag für SMT  
PCB-Layout Proposal for SMT

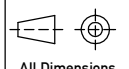

BA 8-13 - 8mm Bauhöhe  
type 8-13 - Low Profile

Information:  All rights reserved. Only for Information. To ensure that this is the latest version of this drawing, please contact one of the ERNI companies before using.	Tolerances  All Dimensions in mm	Scale 3:1	Designation <b>Messerl. SMC-Q 80-SMD-BA8-13</b> <b>Male SMC-Q 80-SMD-type8-13</b>	
	Subject to modification without prior notice. Drawing will not be updated.	 www.ERNI.com	<b>100503140001</b>	K A3
d Index	23.07.2013 Date	Class SMCQ		

Copyright by ERNI GmbH  
Proprietary notice pursuant to ISO 16016 to be observed.