

R Series

Two-Stage General Purpose RFI Power Line Filter



**UL Recognized
CSA Certified
VDE Approved**

R Series

Corcom's dual T section RFI power line filters provide premium performance at moderate cost. They are well suited for low impedance loads where noisy RFI environments are present. They control pulsed, continuous and/or intermittent interference, insuring protection of your equipment from power line noise in addition to protecting the line from equipment noise. The R series dual T type provides low leakage current without deterioration of insertion loss characteristics and at a competitive cost. The ER models meet the very low leakage current requirements of VDE portable equipment, and (120 Volt) UL544 nonpatient medical equipment.

Electrical Schematic

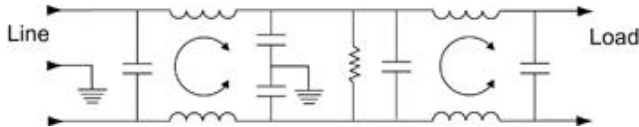

Resistor location for reference only.

Case Style

Metric shown in italics.

R7 & R7M

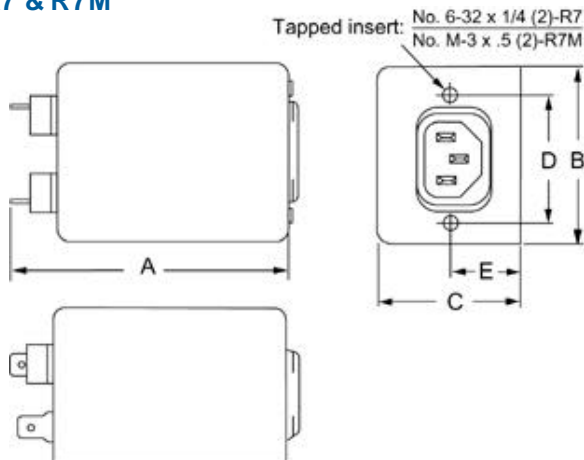

Typical dimensions

Terminals: $\frac{.250}{6.35}$ Holes: $\frac{.07}{1.8}$ Dia.(4) Slot: $\frac{.07 \times .16}{1.8 \times 4.1}$



Specifications

Maximum leakage current, each line-to-ground	VR Models		ER Models	
	@ 120 VAC 60 Hz:	.4 mA	@ 250 VAC 50 Hz:	.21 mA
Hipot rating (one minute):				
line-to-ground		2250 VDC		
line-to-line		1450 VDC		
Operating frequency:		50/60 Hz		
Rated voltage:		120/250 VAC		
Rated current:	@120 VAC	@ 250 VAC		
1VR/1ER	1A	1A		
2VR/2ER	2A	2A		
3VR/3ER	3A	3A		
5VR/5ER	5A	5A		
10VR/10ER	10A	8A		
20VR/20ER	20A	16A		

Minimum insertion loss in dB:

Line-to-ground in 50 ohm circuit

Current Rating	Frequency-MHz					
	.15	.5	1	5	10	30

VR Models

1A, 3A	30	65	65	65	65	65
2A, 5A, 10A, 20A	5	44	60	65	65	60

ER Models

1A, 3A	25	60	65	65	65	65
2A, 5A, 10A, 20A	2	35	51	63	60	50

Line-to-line in 50 ohm circuit

Current Rating	Frequency-MHz					
	.15	.5	1	5	10	30

VR, ER Models

1A, 3A	-	-	65	60	54	46
2A, 5A, 10A, 20A	-	-	35	60	57	45

Recommended Panel Cutout

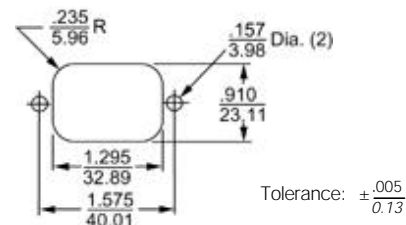

Panel cutout (Back mount)

Case Styles

Metric shown in italics.

R1 (Except 20 Amp)

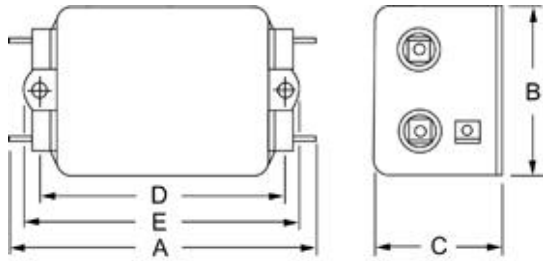

Typical dimensions

Terminals: $\frac{.250}{6.35}$ (5) Holes: $\frac{.07}{1.8}$ Dia.(4) Slot: $\frac{.07 \times .16}{1.8 \times 4.1}$ Mounting holes: $\frac{.188}{4.78}$ Dia.(2)

R3

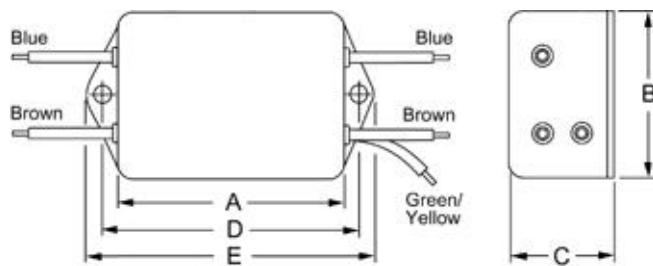

Typical dimensions

Wire leads: $\frac{4.0}{101.6}$ Min. Mounting holes: $\frac{.188}{4.78}$ Dia. (2)

10VR6

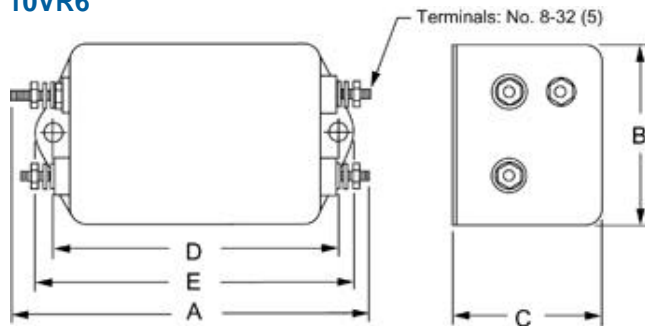

Typical Dimensions

Mounting holes: $\frac{.188}{4.78}$ Dia. (2) Torque 18 ± 2 in.lb.

20VR6

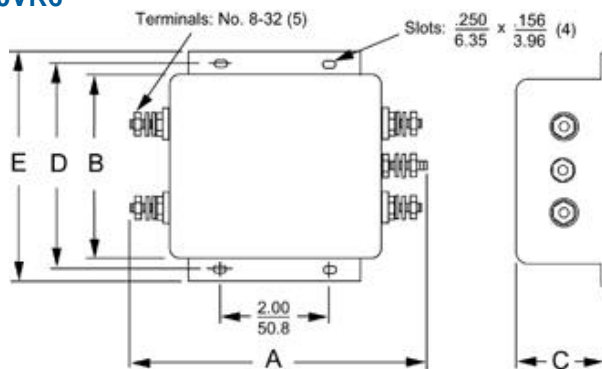

Torque 18 ± 2 in.lb.

Note: Same layout for 20VR1, except $\frac{.250}{6.35}$ (5) Terminals replace screw terminals of 20VR6

Case Dimensions

Metric shown in italics.

Part No.	A (max)	B (max)	C (max)	D $\pm .015$ $\pm .38$	E (max)
1VR1, 1ER1	3.35	1.81	1.16	2.375	2.78
2VR1, 2ER1	85.1	46.0	29.5	60.33	70.6
1VR3, 1ER3	2.07	1.81	1.16	2.375	2.78
2VR3, 2ER3	52.6	46.0	29.5	60.33	70.6
3VR1, 3ER1	3.85	2.07	1.16	2.938	3.35
5VR1, 5ER1	97.8	52.6	29.5	74.63	85.1
3VR3, 3ER3	2.56	2.07	1.16	2.938	3.35
5VR3, 5ER3	65.0	52.6	29.5	74.63	85.1
3VR7, 3VR7M	4.33	2.25	1.28	1.575	0.64 †
3ER7, 3ER7M	110.0	57.2	32.5	40.01	16.3
5VR7, 5VR7M	4.33	2.25	1.28	1.575	0.64 †
5ER7, 5ER7M	110.0	57.2	32.5	40.01	16.3 †
10VR1, 10ER1	3.85	2.07	1.53	2.938	3.35
	97.8	52.6	38.9	74.63	85.1
10VR3, 10ER3	2.56	2.07	1.53	2.938	3.35
	65.0	52.6	38.9	74.63	85.1
10VR6	3.96	2.07	1.53	2.938	3.35
	100.6	52.6	38.9	74.63	85.1
10VR7, 10VR7M	4.33	2.25	1.53	1.575	0.88 †
10ER7, 10ER7M	110.0	57.2	38.9	40.01	22.4
20VR1, 20ER1	5.23	3.37	1.53	3.75	4.2
	132.8	85.6	38.9	95.25	106.7
20VR6	5.34	3.37	1.53	3.75	4.2
	135.6	85.6	38.9	95.25	106.7

† $\pm .02$
 $\pm .5$

Ordering Information

Consult your local Corcom sales representative for pricing.

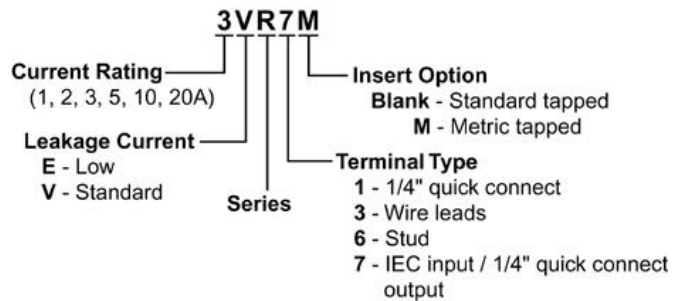

Available Part Numbers

1VR1	5VR7	1ER1	5ER3
1VR3	5VR7M	1ER3	5ER7
2VR1	10VR1	2ER1	5ER7M
2VR3	10VR3	2ER3	10ER1
3VR1	10VR6	3ER1	10ER3
3VR3	10VR7	3ER3	10ER7
3VR7	10VR7M	3ER7	10ER7M
3VR7M	20VR1	3ER7M	20ER1
5VR1	20VR6	5ER1	
5VR3			

Line Cord

Line Cord No. GA400:

7 1/2 foot, 3-conductor line cord to mate with R7 models.