

Photologic® Slotted Optical Switch OPB960, OPB970, OPB980, OPB990 Series

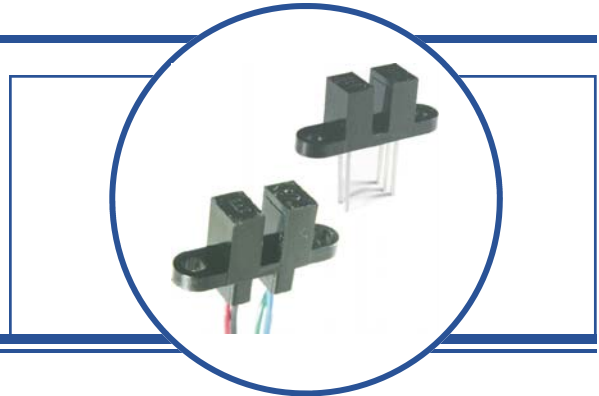

Features:

- Choice of logic and output driver circuits
- Choice of aperture size, covered or open
- Wire or PCB leads
- Choice of mounting features
- Direct TTL, LSTTL, CMOS Interface



Description:

The OPB960/ 970/ 980/ 990 series of non-contact Photologic® slotted optical switches provides flexibility in meeting application specific requirements for the design engineer.

Building from a standard housing with a 0.125" (3.18mm) wide slot, the user can specify output logic state, output driver circuit, aperture width, aperture surface and mounting tab locations. Furthermore, an option of wire or PCB leads allows electrical interface flexibility.

The device body is an opaque plastic which minimizes sensitivity to both visible and near-infrared external light sources which may impact operation. Aperture width choices provide different optical resolution for motion sensing. A covered aperture provides dust protection, while an open aperture provides maximum protection against external light sources.

Electrical operation is over a wide supply voltage range. LED emissions are near-infrared (850—940nm). Detector digital output logic choices of buffer or inverter with totem-pole or open-collector driver circuit simplify interface for various electrical requirements.

Custom electrical, wire and cabling services are available.

Contact your local representative or OPTEK for more information. Compliant to EU RoHS Directive 2002/95/EC .

Applications:

For more information see Application notes 201, 213

- Speed and direction indication
- Mechanical switch replacement
- Printers - Top of form, End of travel, Home position.
- Rotary encoders
- Mechanical limit indication
- Sliding Door Automotive and Lift gate applications

Part Number Guide

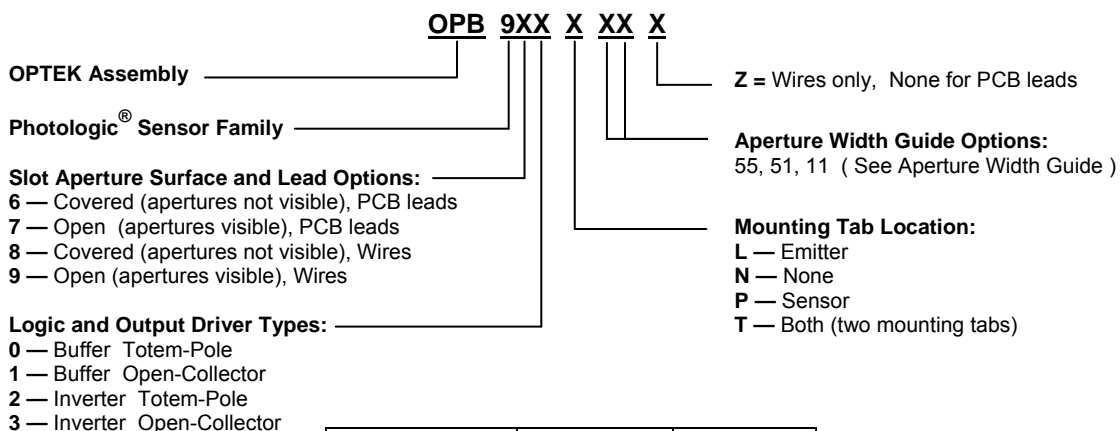

Logic Type	Input LED	Output Logic State
Buffer	OFF	LOW = 0
Inverter	OFF	HIGH = 1



RoHS

OPTEK reserves the right to make any changes at any time in order to improve design and to supply the best product possible.

Photologic[®] Slotted Optical Switch OPB960, OPB970, OPB980, OPB990 Series



PACKAGE OUTLINE for OPB960 and OPB970 Series

TABLE 1

Lead No.	Function
1	Anode
2	Cathode
3	Vcc
4	Output
5	Ground

APERTURE WIDTH GUIDE		
CODE	LED	SENSOR
55	.050" [1.27mm]	.050" [1.27mm]
51	.050" [1.27mm]	.010" [0.25mm]
11	.010" [0.25mm]	.010" [0.25mm]
Lengths are .050" [1.27mm]		

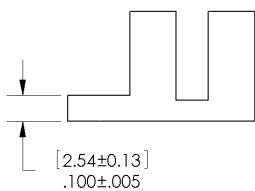
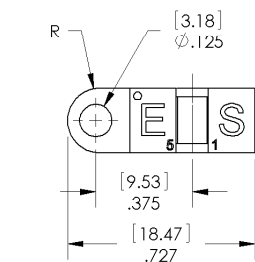
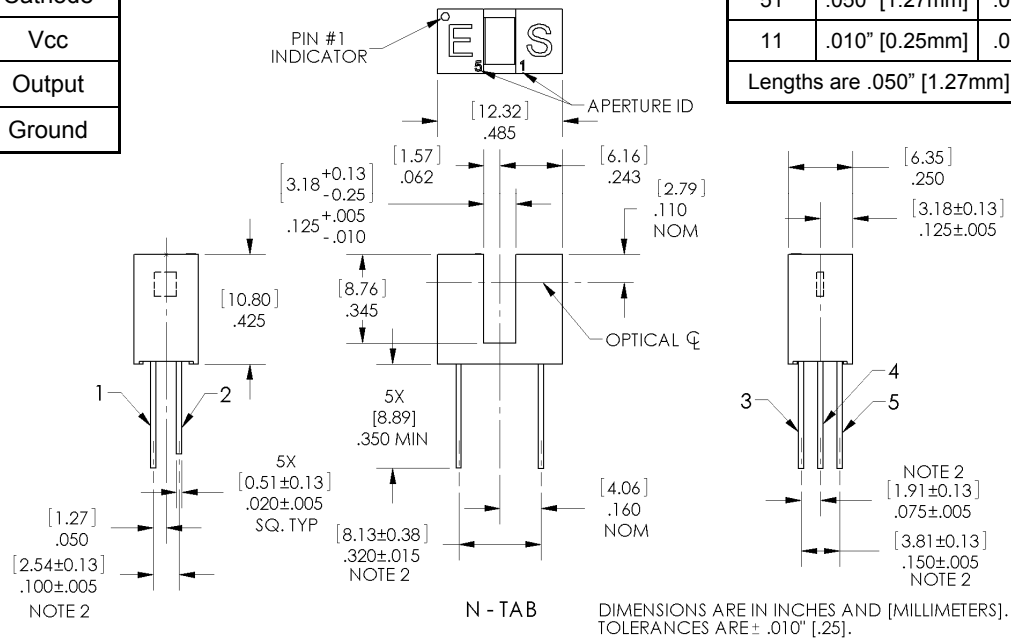

L - TAB

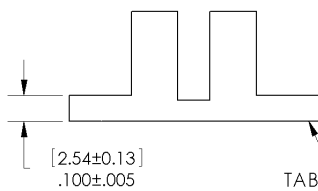
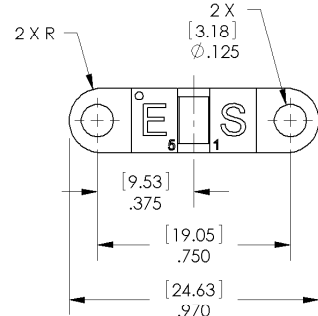

T - TAB

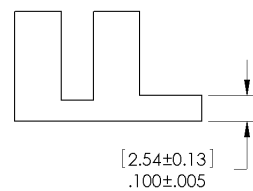
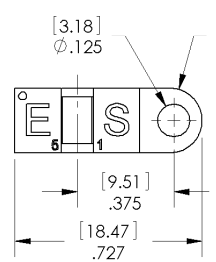

P - TAB

Notes:

- (1) RMA flux recommended. Duration can be extended to 10 seconds max.
- (2) Feature controlled at body.
- (3) Highly activated water soluble fluxes may attack plastic. Recommend trial to verify application.
- (4) Maximum lead soldering temperature [1.6mm from case for 5 seconds with soldering iron] 260° C.
- (5) Cathode lead may be shorter.
- (6) Part number marking may be on any side.

OPTEK reserves the right to make any changes at any time in order to improve design and to supply the best product possible.

Photologic[®] Slotted Optical Switch OPB960, OPB970, OPB980, OPB990 Series



PACKAGE OUTLINE for OPB980 and OPB990 Series

TABLE 2

Wire Color	Function
Red	Anode
Black	Cathode
White	Vcc
Blue	Output
Green	Ground

APERTURE WIDTH GUIDE		
CODE	LED	SENSOR
55	.050" [1.27mm]	.050" [1.27mm]
51	.050" [1.27mm]	.010" [0.25mm]
11	.010" [0.25mm]	.010" [0.25mm]
Lengths are .050" [1.27mm]		

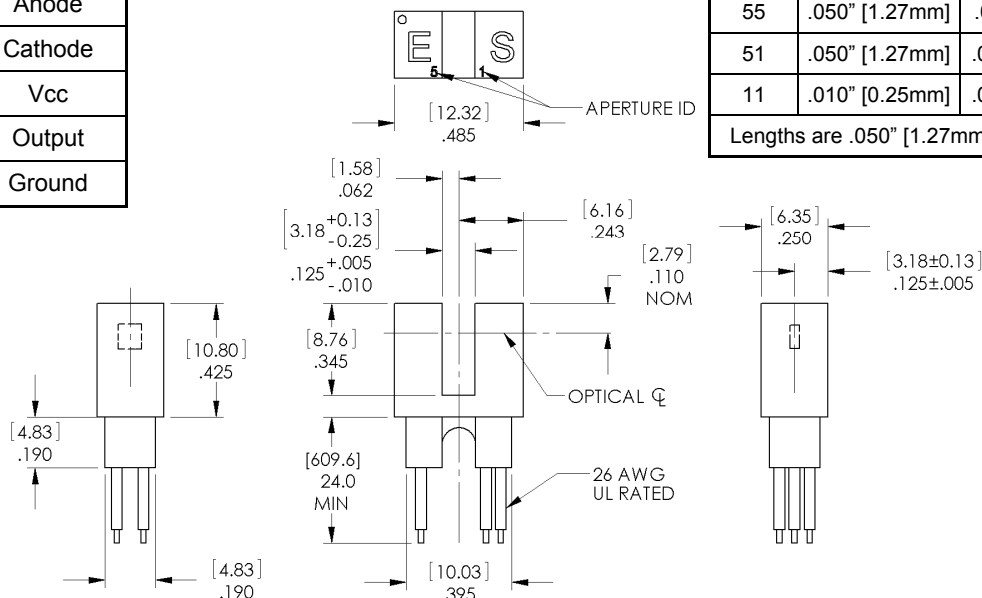

N - TAB DIMENSIONS ARE IN INCHES AND [MILLIMETERS]. TOLERANCES ARE ± .010 [0.25]

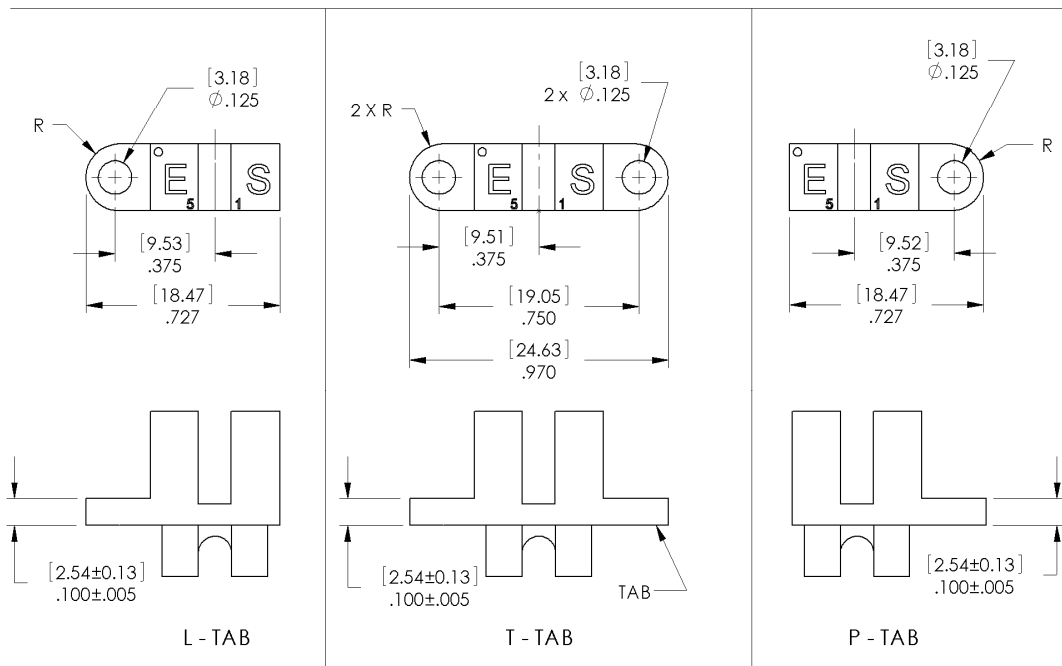

- Notes:
- (7) Wire is 26AWG, UL Rated PVC insulation.
 - (8) Ideal torque for bolt or screw 0,45 to 0,68 Nm (4 to 6 Lb-in).
 - (9) When using a thread lock compound, ND Industries "ND Vibra-Tite[®] Formula 3" will avoid stress cracking plastic.
 - (10) Plastic is soluble in chlorinated hydrocarbons and ketones. Methanol or isopropanol are recommended as cleaning agents.

OPTEK reserves the right to make any changes at any time in order to improve design and to supply the best product possible.

Absolute Maximum Ratings

Storage Temperature Range	-40°C to +85° C
Operating Temperature Range	-40°C to +70° C
Input Diode (E)	
Input Diode Power Dissipation	100 mW ⁽¹¹⁾
Input Diode Forward D.C. Current, T _A = 25°C	40 mA ⁽¹⁴⁾
Input Diode Reverse D.C. Voltage, T _A = 25°C	2 V
Sensor (S)	
Supply Voltage (V _{CC} to Ground)	18 V ⁽¹³⁾
Output Photologic [®] Power Dissipation	200 mW ⁽¹²⁾
Voltage at Output Lead (Open-Collector Output), T _A = 25°C	35V
Short Circuit Output Current to Ground (I _{OS}) 1 sec Max.	30 mA

Notes:

- (11) Derate linearly 2.22 mW / °C above 25° C.
- (12) Derate linearly 4.44 mW / °C above 25° C.
- (13) Prior to 2004 Vcc was limited to 5.5V maximum.
- (14) Do not connect input diode directly to a voltage source without an external current limiting resistor.

Block Diagram

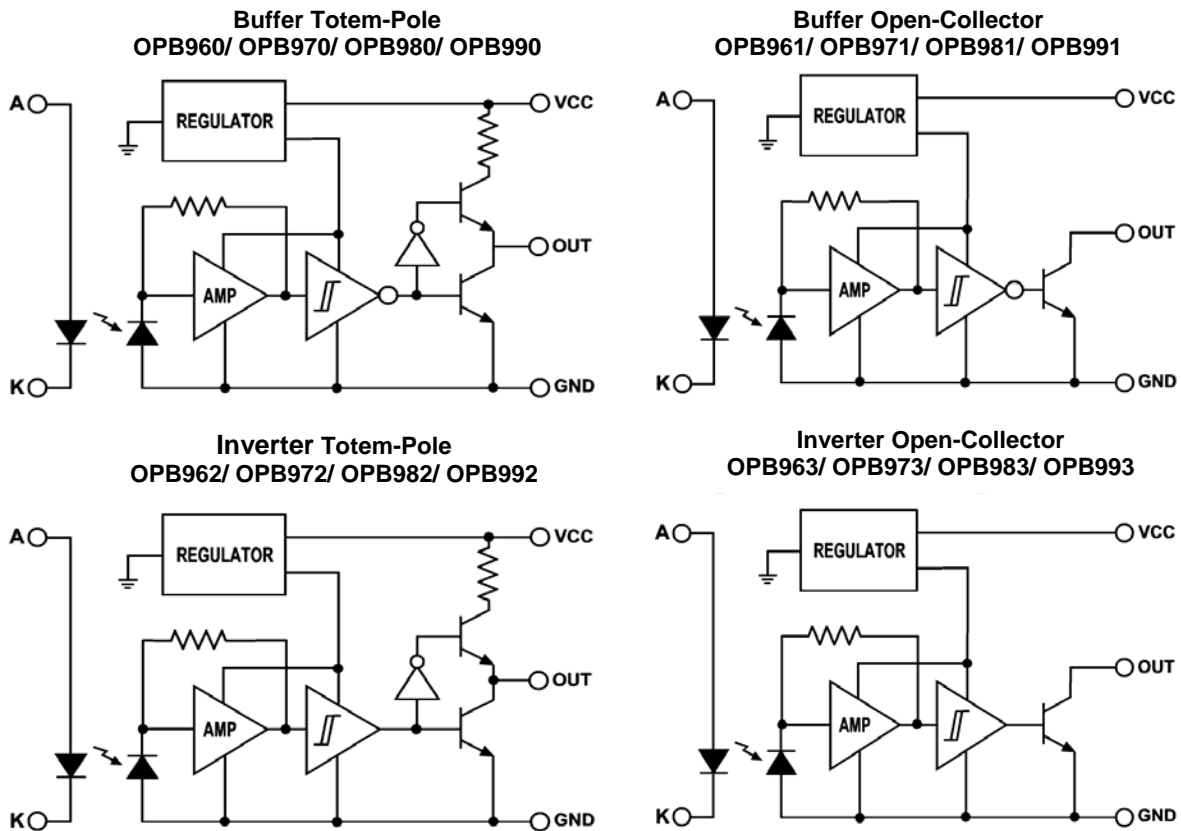

OPTEK reserves the right to make any changes at any time in order to improve design and to supply the best product possible.

Photologic® Slotted Optical Switch

OPB960, OPB970, OPB980, OPB990 Series



Electrical Characteristics (T_A = -40° C to +70° C unless otherwise noted)

SYMBOL	PARAMETER	MIN	TYP	MAX	UNITS	TEST CONDITIONS
--------	-----------	-----	-----	-----	-------	-----------------

Input Diode (See OP140 / OP240 LED for additional information)

V _F	Forward Voltage	-	-	1.70	V	I _F = 20 mA, T _A = 25° C
I _R	Reverse Current	-	-	100	μA	V _R = 2.0 V, T _A = 25° C

Coupled (See OPL560 Detector for additional information)

V _{CC}	Operating D.C. Supply Voltage	4.5	-	16	V		
I _{CC}	Supply Current	-	-	12	mA	V _{CC} = 4.5V to 16V	
V _{OL}	Low Level Output Voltage:	-	-	0.4	V	V _{CC} = 4.5V, I _{OL} = 12.8mA I _F = 0 mA ⁽¹⁴⁾	
	Buffer Totem-Pole						OPB960,OPB970 OPB980,OPB990
	Buffer Open-Collector						OPB961,OPB971 OPB981,OPB991
	Inverter Totem-Pole						OPB962,OPB972 OPB982,OPB992
	Inverter Open-Collector	OPB963,OPB973 OPB983,OPB993				V _{CC} = 4.5V, I _{OL} = 12.8mA I _F = 15 mA	
V _{OH}	High Level Output Voltage:	V _{CC} -2.1	-	-	V	V _{CC} = 4.5V to 16V, I _{OH} = -800μA I _F = 15 mA	
	Buffer Totem-Pole						OPB960,OPB970 OPB980,OPB990
	Inverter Totem-Pole	OPB962,OPB972 OPB982,OPB992				V _{CC} = 4.5V to 16V, I _{OH} = -800μA I _F = 0 mA ⁽¹⁴⁾	
I _{OH}	High Level Output Current:	-	-	100	μA	V _{CC} = 4.5V to 16V, V _{OH} = 30V I _F = 15 mA	
	Buffer Open-Collector						OPB961,OPB971 OPB981,OPB991
	Inverter Open-Collector	OPB963,OPB973 OPB981,OPB991				V _{CC} = 4.5V to 16V, V _{OH} = 30V I _F = 0 mA ⁽¹⁴⁾	
I _F (+)	LED Positive-Going Threshold Current ⁽¹⁶⁾	-	-	15	mA	V _{CC} = 5.0V, T _A = 25° C	
I _F (+) / I _F (-)	Hysteresis Ratio	-	1.5	-	-	V _{CC} = 5.0V	
t _R , t _F	Output Rise Time, Output Fall Time	-	70	-	ns	V _{CC} = 5.0V, I _{F peak} = 15 mA, T _A = 25° C 100 kHz square wave, C = 10pF max.	
t _{PLH} , t _{PHL}	Propagation Delay Time Low to High, High to Low	-	5.0	-	μs	R _L = 360 Ω to GND (Totem-Pole) R _L = 1KΩ pull-up (Open-Collector)	

Notes:

- 14) Normal application would be with light source blocked, simulated by I_F = 0 mA.
- 15) All parameters are tested using pulse techniques.
- 16) An increasing current applied to the LED which causes the output logic state to change. For proper application I_F(+), LED current, should be more than the stated maximum.

OPTEK reserves the right to make any changes at any time in order to improve design and to supply the best product possible.

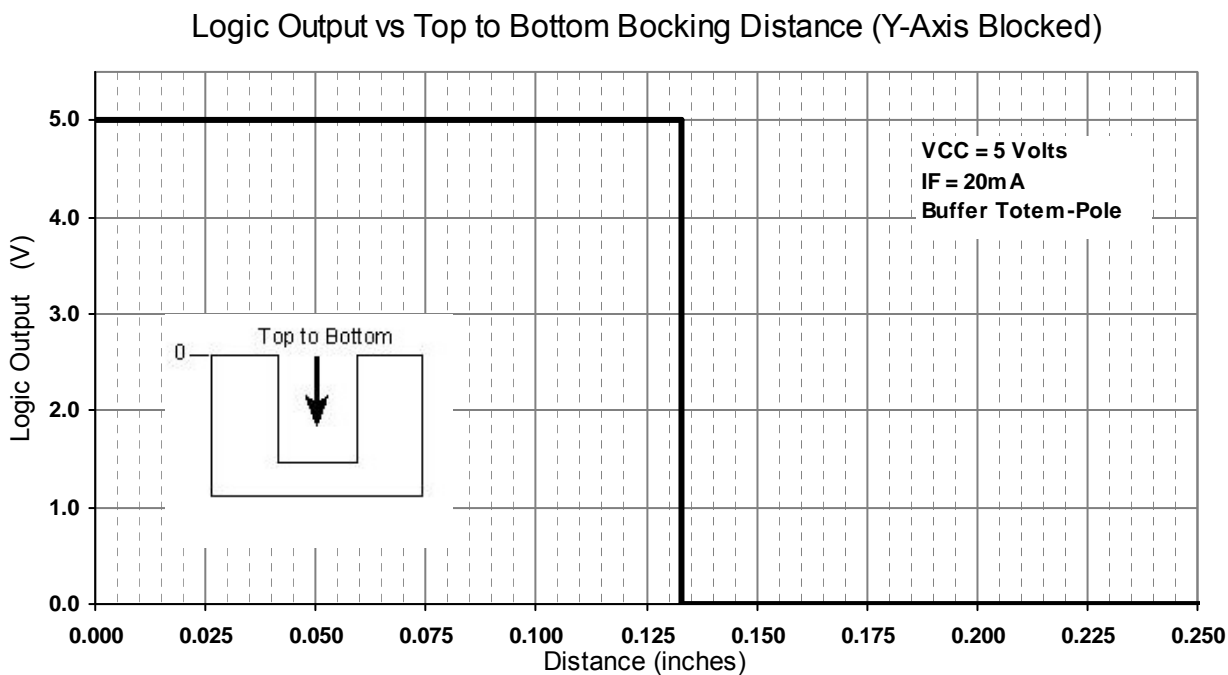
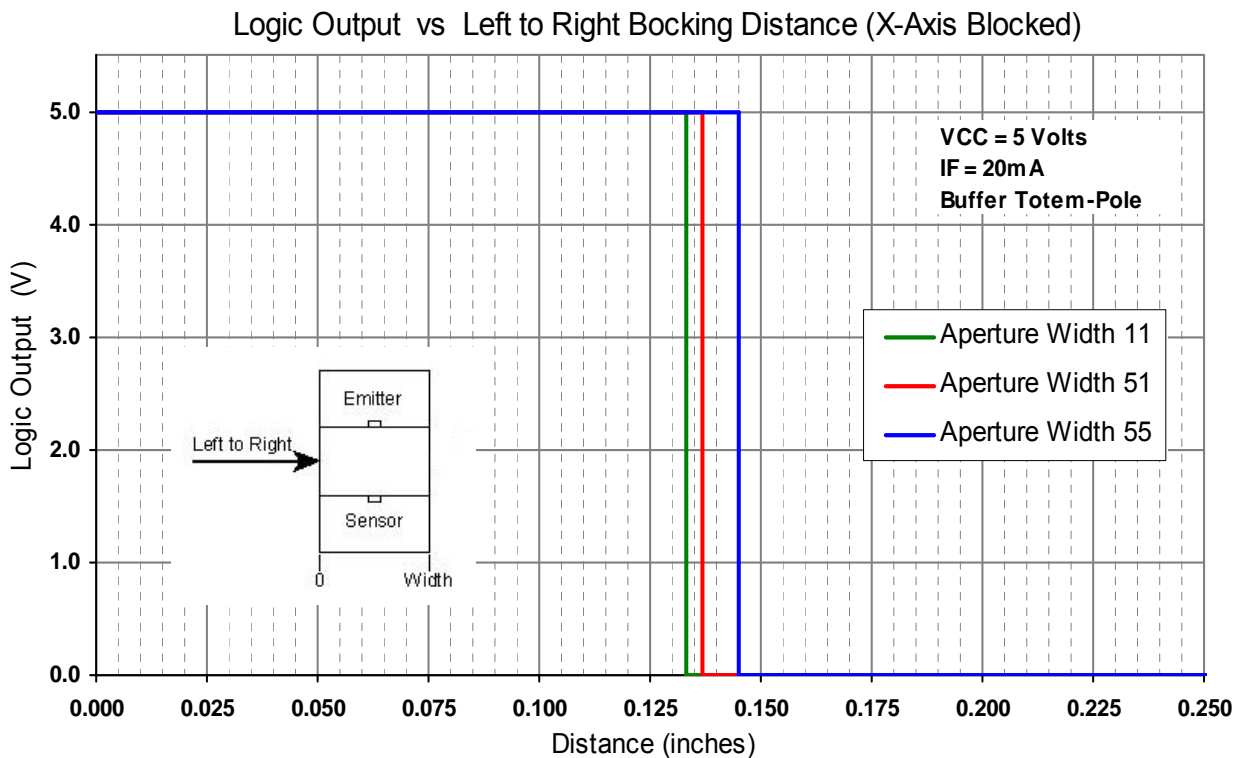

OPTEK reserves the right to make any changes at any time in order to improve design and to supply the best product possible.

Mouser Electronics

Authorized Distributor

Click to View Pricing, Inventory, Delivery & Lifecycle Information:

Optek:

[OPB990L11](#) [OPB972T51](#) [OPB972N51](#) [OPB982L51](#) [OPB982L55](#) [OPB982N11](#) [OPB982N51](#) [OPB982N55](#)
[OPB982P11](#) [OPB982P51](#) [OPB982P55](#) [OPB982T11](#) [OPB982T55](#) [OPB983L11](#) [OPB983L51](#) [OPB983L55](#)
[OPB983N11](#) [OPB983N51](#) [OPB983N55](#) [OPB983P11](#) [OPB983P51](#) [OPB983P55](#) [OPB983T11](#) [OPB983T51](#)
[OPB983T55](#) [OPB990L51](#) [OPB990L55](#) [OPB990N11](#) [OPB990N51](#) [OPB990N55](#) [OPB990P11](#) [OPB990P55](#)
[OPB990T11](#) [OPB990T51](#) [OPB990T55](#) [OPB991L11](#) [OPB991L51](#) [OPB991L55](#) [OPB991N11](#) [OPB991N51](#)
[OPB992L11](#) [OPB992L51](#) [OPB992L55](#) [OPB992N11](#) [OPB992N51](#) [OPB992N55](#) [OPB993N11](#) [OPB993N51](#)
[OPB993N55](#) [OPB993P11](#) [OPB993P51](#) [OPB993P55](#) [OPB993T11](#) [OPB993T51](#) [OPB980L11Z](#) [OPB980L51Z](#)
[OPB980L55Z](#) [OPB980N11Z](#) [OPB980N51Z](#) [OPB980N55Z](#) [OPB980P11Z](#) [OPB980P51Z](#) [OPB980P55Z](#)
[OPB980T11Z](#) [OPB980T51Z](#) [OPB980T55Z](#) [OPB981L11Z](#) [OPB981L51Z](#) [OPB981L55Z](#) [OPB981N11Z](#) [OPB981N51Z](#)
[OPB981N55Z](#) [OPB981P11Z](#) [OPB981P51Z](#) [OPB981P55Z](#) [OPB981T11Z](#) [OPB981T51Z](#) [OPB981T55Z](#)
[OPB982L11Z](#) [OPB982L51Z](#) [OPB982L55Z](#) [OPB982N11Z](#) [OPB982N51Z](#) [OPB982N55Z](#) [OPB982P11Z](#) [OPB982P51Z](#)
[OPB982P55Z](#) [OPB982T11Z](#) [OPB982T51Z](#) [OPB982T55Z](#) [OPB983L11Z](#) [OPB983L51Z](#) [OPB983L55Z](#)
[OPB983N11Z](#) [OPB983N51Z](#) [OPB983N55Z](#) [OPB983P11Z](#) [OPB983P51Z](#) [OPB983P55Z](#) [OPB983T11Z](#)