

3209 AND 3210

Data Sheet
27622.60C

MICROPOWER, ULTRA-SENSITIVE HALL-EFFECT SWITCHES

Package Suffix 'LH' Pinning (SOT23W)

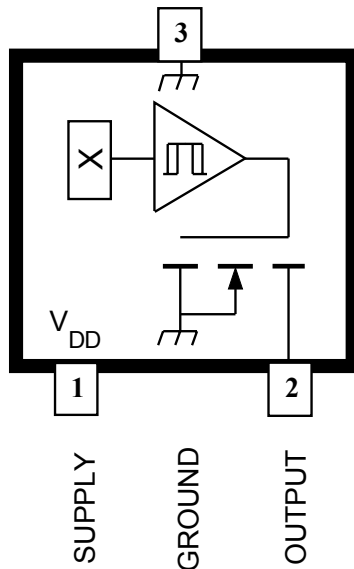

Dwg. PH-016-1

Pinning is shown viewed from branded side.

ABSOLUTE MAXIMUM RATINGS at $T_A = +25^\circ\text{C}$

Supply Voltage, V_{DD}	5 V
Magnetic Flux Density, B	Unlimited
Output Off Voltage, V_{OUT}	5 V
Output Current, I_{OUT}	1 mA
Junction Temperature, T_J	+170°C
Operating Temperature Range, T_A	-40°C to +85°C
Storage Temperature Range, T_S	-65°C to +170°C

Caution: These CMOS devices have input static protection (Class 3) but are still susceptible to damage if exposed to extremely high static electrical charges.

The A3209Ex and A3210Ex integrated circuits are ultra-sensitive, pole independent Hall-effect switches with a latched digital output. They are especially suited for operation in battery-operated, hand-held equipment such as cellular and cordless telephones, pagers, and palmtop computers. 2.5 volt to 3.5 volt operation and a unique clocking scheme to reduce the average operating power requirements – the A3209Ex to 400 μW , the A3210Ex to 25 μW ! Except for operating duty cycle and average operating current, the A3209Ex and A3210Ex are identical.

Unlike other Hall-effect switches, either a north or south pole of sufficient strength will turn the output on; in the absence of a magnetic field, the output is off. The polarity independence and minimal power requirement allows these devices to easily replace reed switches for superior reliability and ease of manufacturing, while eliminating the requirement for signal conditioning.

Improved stability is made possible through chopper stabilization (dynamic offset cancellation), which reduces the residual offset voltage normally caused by device overmolding, temperature dependencies, and thermal stress.

These devices include on a single silicon chip a Hall-voltage generator, small-signal amplifier, chopper stabilization, a latch, and a MOSFET output. Advanced BiCMOS processing is used to take advantage of low-voltage and low-power requirements, component matching, very low input-offset errors, and small component geometries.

The A3209Ex and A3210Ex are rated for operation over a temperature range of -40°C to +85°C. Two package styles provide a magnetically optimized package for most applications. Suffix 'LH' is a miniature low-profile surface-mount package while suffix 'UA' is a three-lead ultra-mini-SIP for through-hole or surface mounting.

FEATURES

- Micropower Operation
- Operate With North or South Pole
- 2.5 V to 3.5 V Battery Operation
- Chopper Stabilized
- Superior Temperature Stability
- Extremely Low Switch-Point Drift
- Insensitive to Physical Stress
- ESD Protected to 5 kV
- Solid-State Reliability
- Small Size
- Easily Manufacturable With Magnet Pole Independence

Always order by complete part number: the prefix 'A' + the basic four-digit part number + the suffix 'E' to indicate operating temperature range + a suffix to indicate package style, e.g., **A3210ELH**.

3209 AND 3210 MICROPOWER, ULTRA-SENSITIVE HALL-EFFECT SWITCHES

FUNCTIONAL BLOCK DIAGRAM

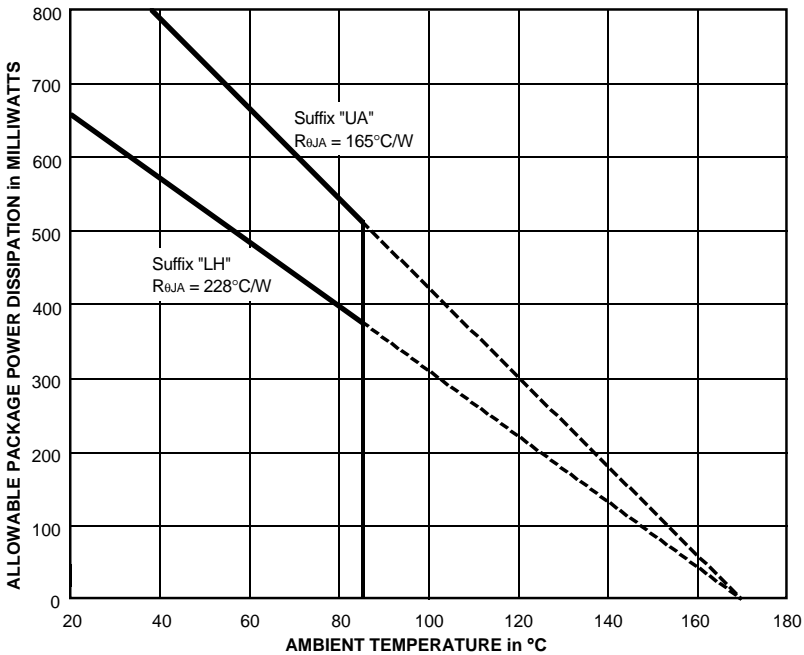
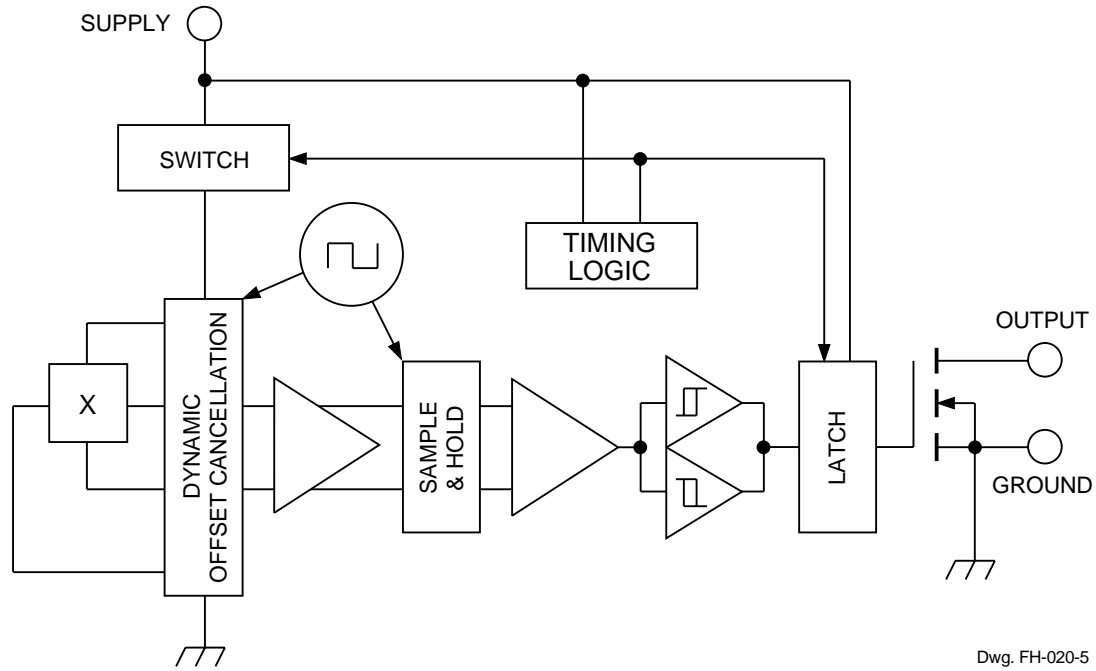

Package Suffix 'UA' Pinning (ultra-mini SIP)

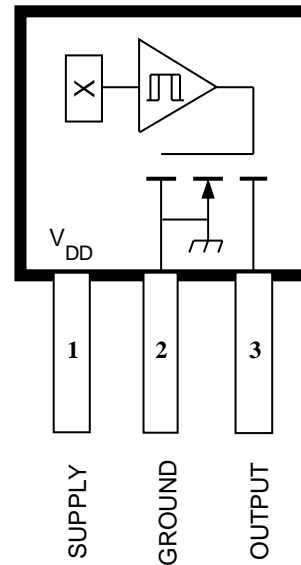

Pinning is shown viewed from branded side.

**3209 AND 3210
MICROPOWER,
ULTRA-SENSITIVE
HALL-EFFECT SWITCHES**

**ELECTRICAL CHARACTERISTICS with $C_{\text{BYPASS}} = 0.1 \mu\text{F}$,
over operating voltage and temperature range (unless otherwise specified).**

Characteristic	Symbol	Test Conditions	Limits			
			Min.	Typ.	Max.	Units
Supply Voltage Range	V_{DD}	Operating ¹⁾	2.5	2.75	3.5	V
Output Leakage Current	I_{OFF}	$V_{\text{OUT}} = 3.5 \text{ V}$, $B_{\text{RPN}} < B < B_{\text{RPS}}$	–	«1.0	1.0	μA
Output On Voltage	V_{OUT}	$I_{\text{OUT}} = 1 \text{ mA}$, $V_{\text{DD}} = 2.5 \text{ V}$	–	105	300	mV
Awake Time	t_{awake}		30	60	90	μs
Period	t_{period}	A3209Ex	240	480	720	μs
		A3210Ex	30	60	90	ms
Duty Cycle	d.c.	A3209Ex	–	12.5	–	%
		A3210Ex	–	0.10	–	%
Chopping Frequency	f_{C}		–	340	–	kHz
Supply Current ($2.5 \leq V_{\text{DD}} \leq 3.5 \text{ V}$)	$I_{\text{DD(EN)}}$	Chip awake (enabled)	0.1	–	3.0	mA
	$I_{\text{DD(DIS)}}$	Chip asleep (disabled)	1.0	10	50	μA
	$I_{\text{DD(AVG)}}$	A3209Ex, $V_{\text{DD}} = 2.75 \text{ V}$	–	145	425	μA
		A3209Ex, $V_{\text{DD}} = 3.5 \text{ V}$	–	195	425	μA
		A3210Ex, $V_{\text{DD}} = 2.75 \text{ V}$	–	8.8	25	μA
		A3210Ex, $V_{\text{DD}} = 3.5 \text{ V}$	–	13	60	μA

- NOTES: 1. Operate and release points will vary with supply voltage.
 2. B_{OPx} = operate point (output turns ON); B_{RPx} = release point (output turns OFF).
 3. Typical Data is at $T_{\text{A}} = +25^{\circ}\text{C}$ and $V_{\text{DD}} = 2.75 \text{ V}$ and is for design information only.

**MAGNETIC CHARACTERISTICS with $C_{\text{BYPASS}} = 0.1 \mu\text{F}$,
over operating voltage and temperature range (unless otherwise specified).**

Characteristic	Symbol	Test Conditions	Limits			
			Min.	Typ.	Max.	Units
Operate Points	B_{OPS}	South pole to branded side	–	30	60	G
	B_{OPN}	North pole to branded side	-60	-35	–	G
Release Points	B_{RPS}	South pole to branded side	5.0	22	–	G
	B_{RPN}	North pole to branded side	–	-27	-5.0	G
Hysteresis	B_{hys}	$ B_{\text{OPx}} - B_{\text{RPx}} $	–	7.7	–	G

- NOTES: 1. As used here, negative flux densities are defined as less than zero (algebraic convention) and -50 G is less than +10 G.
 2. Typical Data is at $T_{\text{A}} = +25^{\circ}\text{C}$ and $V_{\text{DD}} = 2.75 \text{ V}$ and is for design information only.

3209 AND 3210 MICROPOWER, ULTRA-SENSITIVE HALL-EFFECT SWITCHES

TYPICAL OPERATING CHARACTERISTICS as a function of temperature

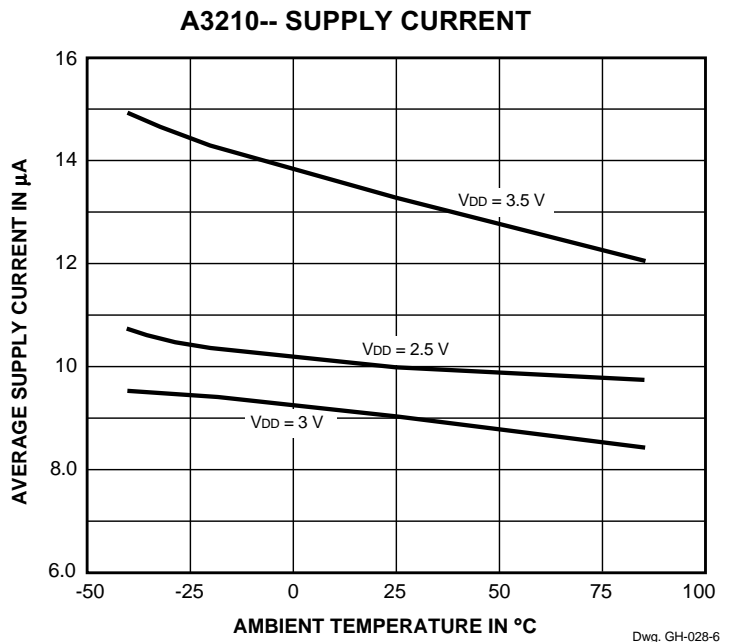
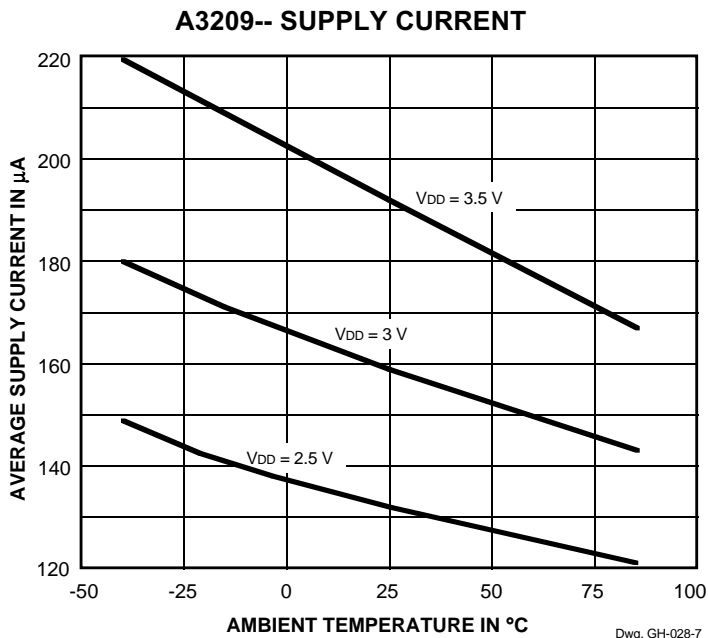
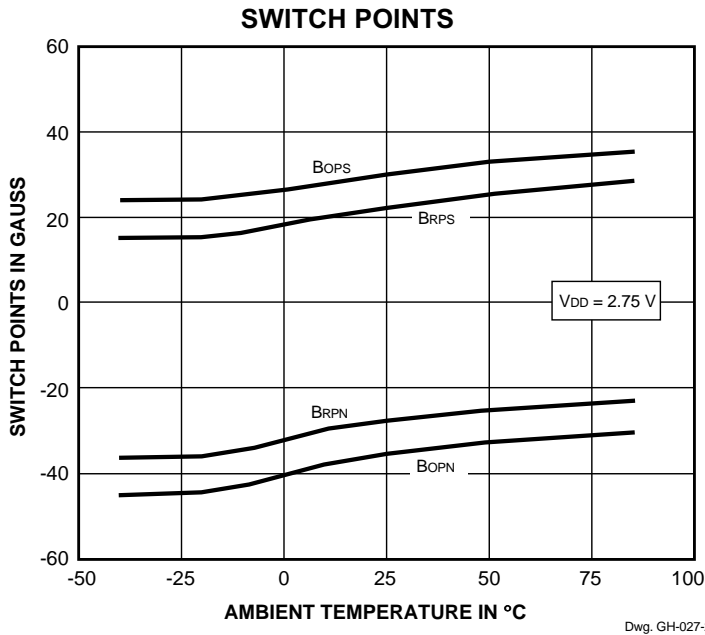

3209 AND 3210 MICROPOWER, ULTRA-SENSITIVE HALL-EFFECT SWITCHES

TYPICAL OPERATING CHARACTERISTICS as a function of supply voltage

SWITCH POINTS

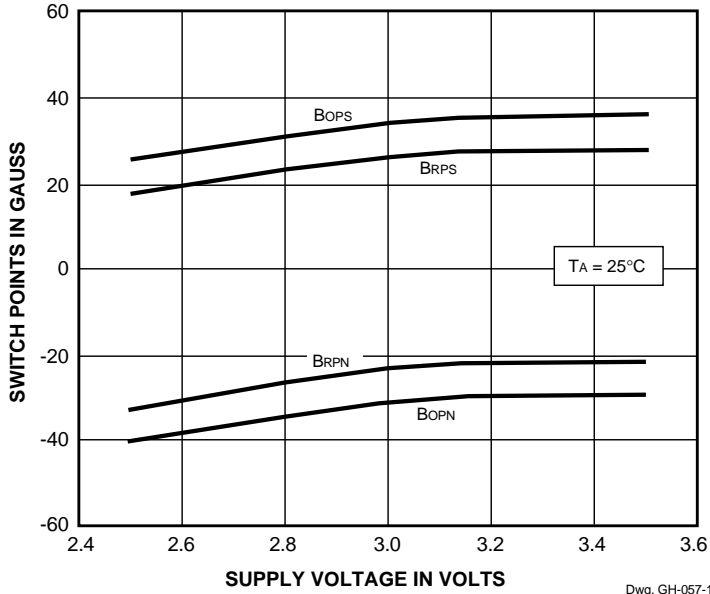

A3209-- SUPPLY CURRENT

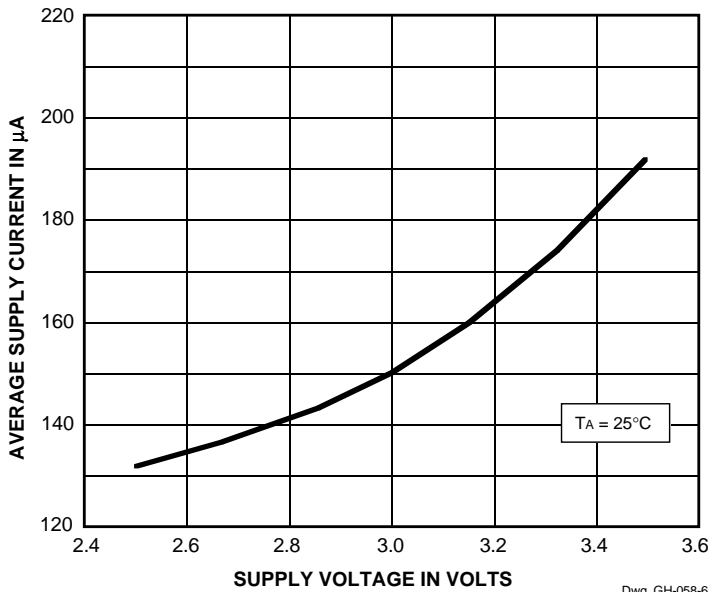

A3210-- SUPPLY CURRENT

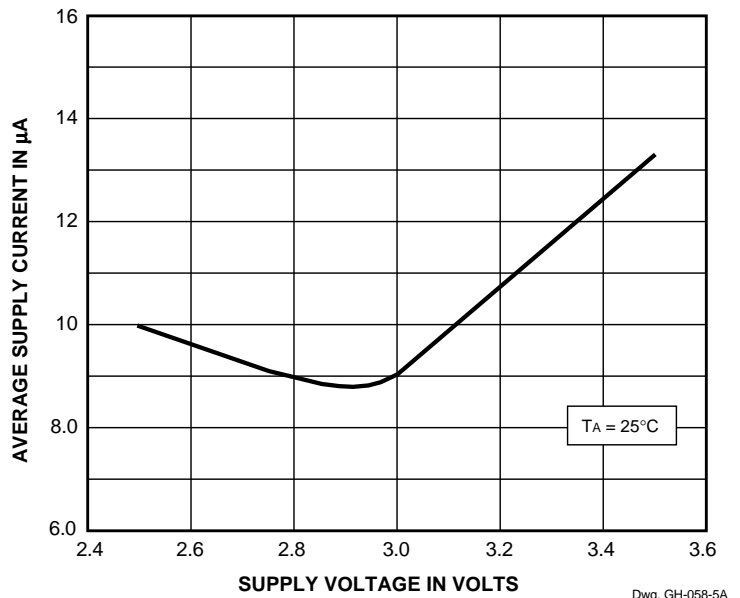

3209 AND 3210 MICROPOWER, ULTRA-SENSITIVE HALL-EFFECT SWITCHES

FUNCTIONAL DESCRIPTION

Low Average Power. Internal timing circuitry activates the device for 60 μs and deactivates it for the remainder of the period (480 μs for the A3209Ex and 60 ms for the A3210Ex). A short "awake" time allows for stabilization prior to the sampling and data latching on the falling edge of the timing pulse. The output during the "sleep" time is latched in the last sampled state. The supply current is not affected by the output state.

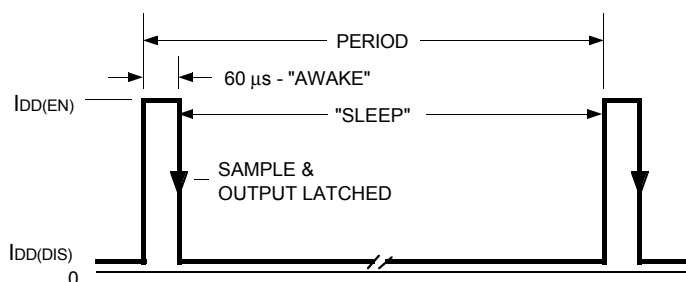

Dwg. WH-017-1

Chopper-Stabilized Technique. The Hall element can be considered as a resistor array similar to a Wheatstone bridge. A large portion of the offset is a result of the mismatching of these resistors. These devices use a proprietary dynamic offset cancellation technique, with an internal high-frequency clock to reduce the residual offset voltage of the Hall element that is normally caused by device overmolding, temperature dependencies, and thermal stress. The chopper-stabilizing technique cancels the mismatching of the resistor circuit by changing the direction of the current flowing through the Hall plate using CMOS switches and Hall voltage measurement taps, while maintaining the Hall-voltage signal that is induced by the external magnetic flux. The signal is then captured by a sample-and-hold circuit and further processed using low-offset bipolar circuitry. This technique produces devices that have an extremely stable quiescent Hall output voltage, are immune to thermal stress, and have precise recoverability after temperature cycling. This technique will also slightly degrade the device output repeatability. A relatively high sampling frequency is used in order that faster signals can be processed.

More detailed descriptions of the circuit operation can be found in: Technical Paper STP 97-10, *Monolithic Magnetic Hall Sensor Using Dynamic Quadrature Offset Cancellation* and Technical Paper STP 99-1, *Chopper-Stabilized Amplifiers With A Track-and-Hold Signal Demodulator*.

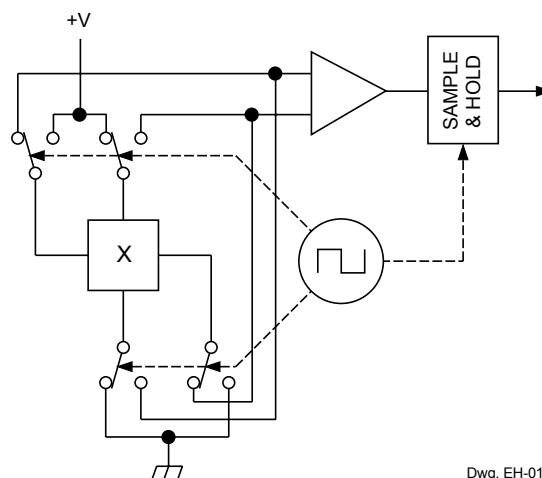

Dwg. EH-012-1

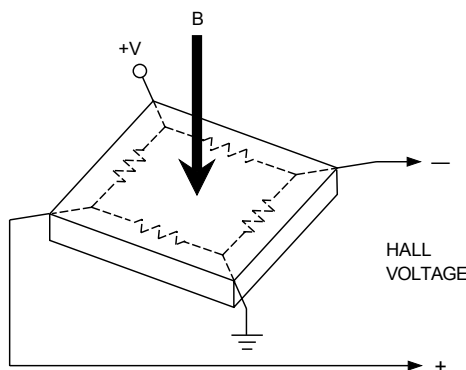

Dwg. AH-011-2

Operation. The output of this device switches low (turns on) when a magnetic field perpendicular to the Hall element exceeds the operate point B_{OPS} (or is less than B_{OPN}). After turn-on, the output is capable of sinking up to 1 mA and the output voltage is $V_{OUT(ON)}$. When the magnetic field is reduced below the release point B_{RPS} (or increased above B_{RPN}), the device output switches high (turns off). The difference in the magnetic operate and release points is the hysteresis (B_{HYS}) of the device. This built-in hysteresis allows clean switching of the output even in the presence of external mechanical vibration and electrical noise.

As used here, negative flux densities are defined as less than zero (algebraic convention) and -50 G is less than +10 G.

3209 AND 3210 MICROPOWER, ULTRA-SENSITIVE HALL-EFFECT SWITCHES

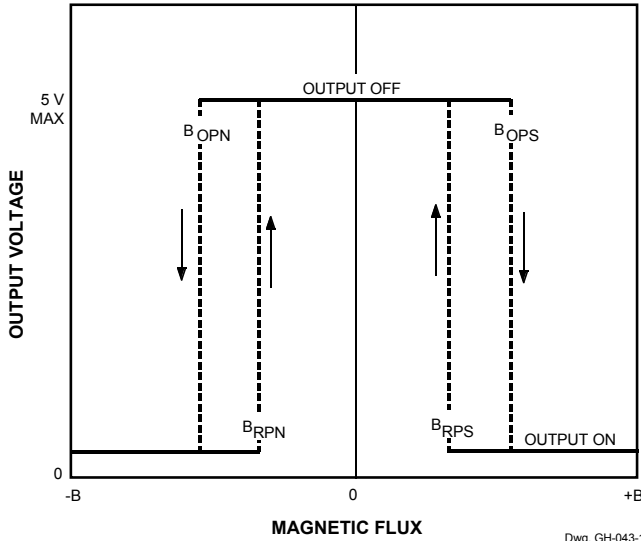

ELEMENT LOCATIONS

Package Designator 'LH'

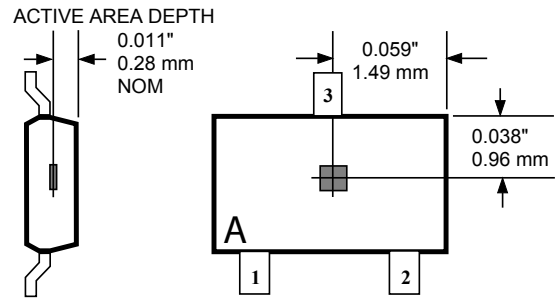

Package Designator 'UA'

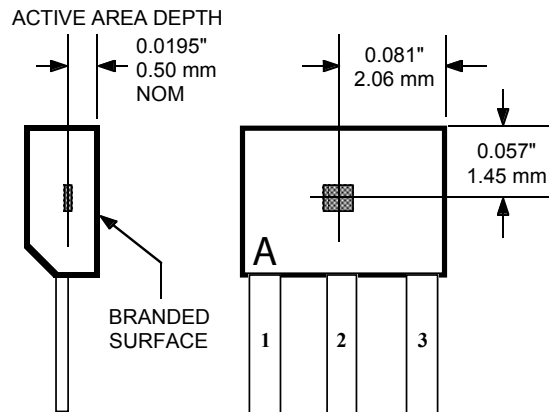

Applications. Allegro's pole-independent sensing technique allows for operation with either a north pole or south pole magnet orientation, enhancing the manufacturability of the device. The state-of-the-art technology provides the same output polarity for either pole face.

It is strongly recommended that an external bypass capacitor be connected (in close proximity to the Hall element) between the supply and ground of the device to reduce both external noise and noise generated by the chopper-stabilization technique. This is especially true due to the relatively high impedance of battery supplies.

The simplest form of magnet that will operate these devices is a bar magnet with either pole near the branded surface of the device. Many other methods of operation are possible. Extensive applications information on magnets and Hall-effect devices is also available in the *Allegro Electronic Data Book* AMS-702 or *Application Note 27701*, or at

www.allegromicro.com

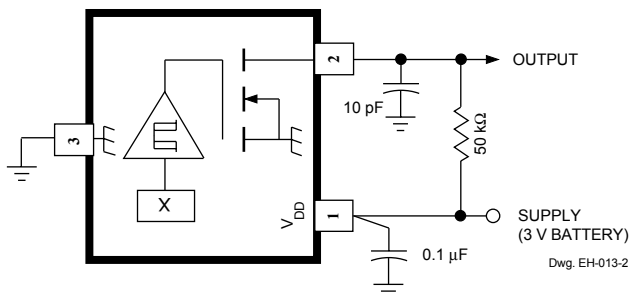

3209 AND 3210 MICROPOWER, ULTRA-SENSITIVE HALL-EFFECT SWITCHES

PACKAGE DESIGNATOR 'LH'

(fits SC-59A solder-pad layout)

Dimensions in Inches
(for reference only)

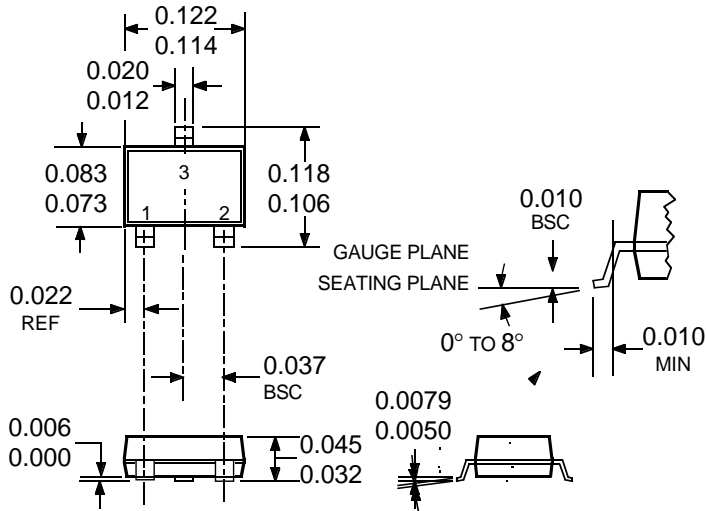

Dwg. MA-010-3D in

Dimensions in Millimeters
(controlling dimensions)

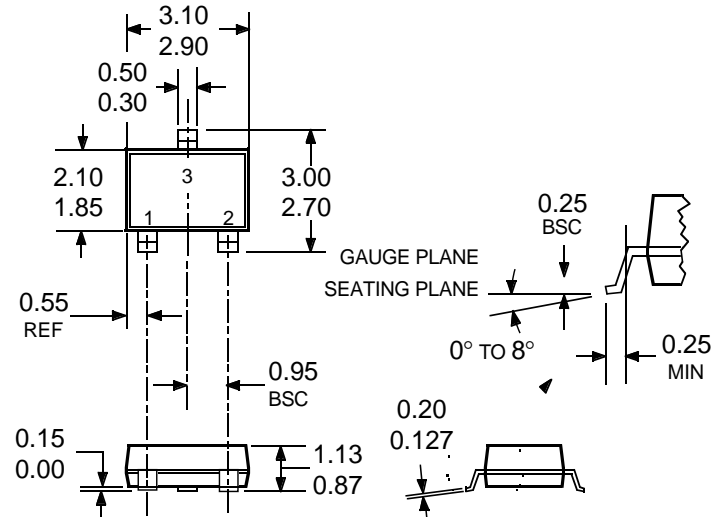

Dwg. MA-010-3D mm

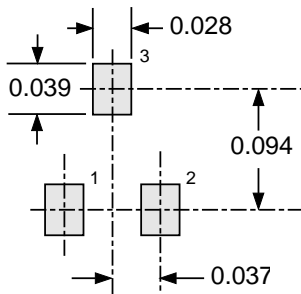

Dwg. MA-011-3 in

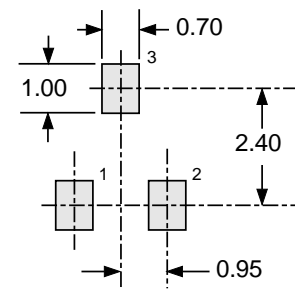

Dwg. MA-011-3 mm

- NOTES:
1. Tolerances on package height and width represent allowable mold offsets. Dimensions given are measured at the widest point (parting line).
 2. Exact body and lead configuration at vendor's option within limits shown.
 3. Height does not include mold gate flash.
 4. Where no tolerance is specified, dimension is nominal.

3209 AND 3210 MICROPOWER, ULTRA-SENSITIVE HALL-EFFECT SWITCHES

PACKAGE DESIGNATOR 'UA'

Dimensions in Inches
(controlling dimensions)

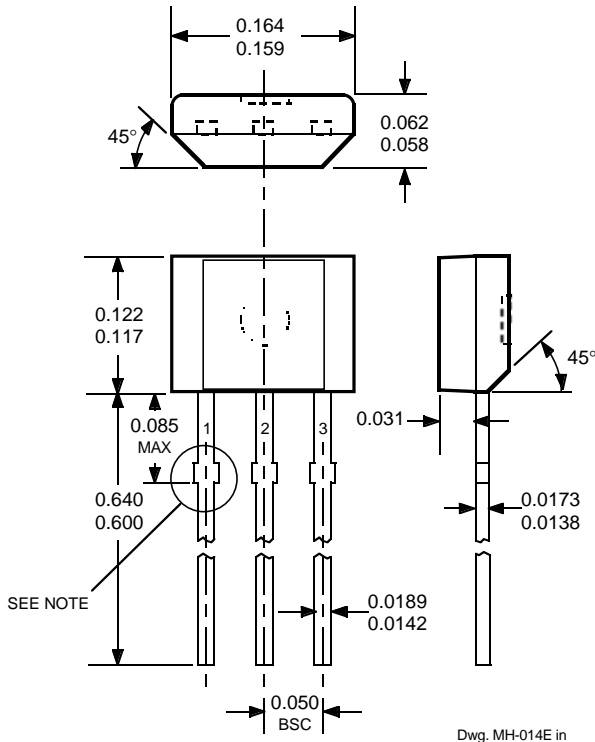

Dimensions in Millimeters
(for reference only)

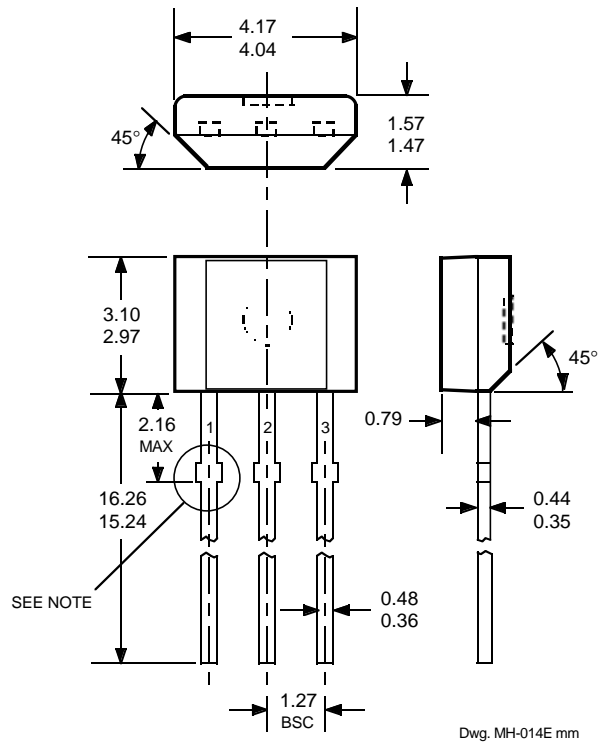

- NOTES: 1. Tolerances on package height and width represent allowable mold offsets. Dimensions given are measured at the widest point (parting line).
2. Exact body and lead configuration at vendor's option within limits shown.
3. Height does not include mold gate flash.
4. Recommended minimum PWB hole diameter to clear transition area is 0.035" (0.89 mm).
5. Where no tolerance is specified, dimension is nominal.
6. Supplied in bulk pack (500 pieces per bag).

Radial Lead Form (order A32xxEUA-LC)

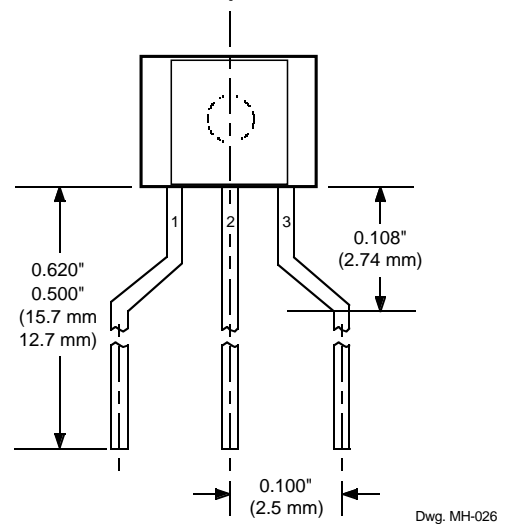

NOTE: Lead-form dimensions are the nominals produced on the forming equipment. No dimensional tolerance is implied or guaranteed for bulk packaging (500 pieces per bag).

**3209 AND 3210
MICROPOWER,
ULTRA-SENSITIVE
HALL-EFFECT SWITCHES**

The products described herein are manufactured under one or more of the following U.S. patents: 5,045,920; 5,264,783; 5,442,283; 5,389,889; 5,581,179; 5,517,112; 5,619,137; 5,621,319; 5,650,719; 5,686,894; 5,694,038; 5,729,130; 5,917,320; and other patents pending.

Allegro MicroSystems, Inc. reserves the right to make, from time to time, such departures from the detail specifications as may be required to permit improvements in the performance, reliability, or manufacturability of its products. Before placing an order, the user is cautioned to verify that the information being relied upon is current.

Allegro products are not authorized for use as critical components in life-support appliances, devices, or systems without express written approval.

The information included herein is believed to be accurate and reliable. However, Allegro MicroSystems, Inc. assumes no responsibility for its use; nor for any infringements of patents or other rights of third parties that may result from its use.