

Pb Free Plating Product

## RHRP30120



30.0 Ampere SwitchMode Single Fast Recovery Epitaxial Diode

## APPLICATION

- Freewheeling, Snubber, Clamp
- Inversion Welder
- PFC
- Plating Power Supply
- Ultrasonic Cleaner and Welder
- Converter & Chopper
- UPS

## PRODUCT FEATURE

- Ultrafast Recovery Time
- Soft Recovery Characteristics
- Low Recovery Loss
- Low Forward Voltage
- High Surge Current Capability
- Low Leakage Current

## TO-220AC

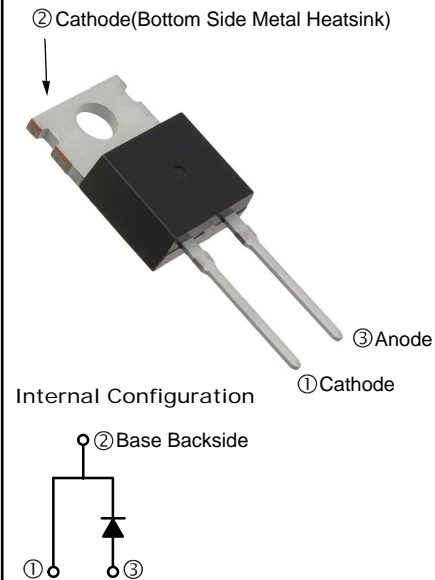

## GENERAL DESCRIPTION

RHRP30120 using latest FRED FAB process(planar passivation pellet) with ultrafast and soft recovery characteristics.

## ABSOLUTE MAXIMUM RATINGS

 $T_C=25^{\circ}\text{C}$  unless otherwise specified

Symbol	Parameter	Test Conditions	Values	Unit
$V_R$	Maximum D.C. Reverse Voltage		1200	V
$V_{RRM}$	Maximum Repetitive Reverse Voltage		1200	V
$I_{F(AV)}$	Average Forward Current	$T_C=110^{\circ}\text{C}$	30	A
$I_{F(RMS)}$	RMS Forward Current	$T_C=110^{\circ}\text{C}$	45	A
$I_{FSM}$	Non-Repetitive Surge Forward Current	$T_J=45^{\circ}\text{C}$ , $t=10\text{ms}$ , 50Hz, Sine	300	A
$P_D$	Power Dissipation		105	W
$T_J$	Junction Temperature		-40 to +150	$^{\circ}\text{C}$
$T_{STG}$	Storage Temperature Range		-40 to +150	$^{\circ}\text{C}$
Torque	Module-to-Sink	Recommended (M3)	1.1	N·m
$R_{\theta JC}$	Thermal Resistance	Junction-to-Case	1.2	$^{\circ}\text{C}/\text{W}$
Weight			2.2	g

## ELECTRICAL CHARACTERISTICS

 $T_C=25^{\circ}\text{C}$  unless otherwise specified

Symbol	Parameter	Test Conditions	Min.	Typ.	Max.	Unit
$I_{RM}$	Reverse Leakage Current	$V_R=1200\text{V}$	--	--	100	$\mu\text{A}$
		$V_R=1200\text{V}$ , $T_J=125^{\circ}\text{C}$	--	--	500	$\mu\text{A}$
$V_F$	Forward Voltage	$I_F=30\text{A}$	--	2.6	3.5	V
		$I_F=30\text{A}$ , $T_J=125^{\circ}\text{C}$	--	2.0	--	V
$t_{rr}$	Reverse Recovery Time	$I_F=1\text{A}$ , $V_R=30\text{V}$ , $di_F/dt=-200\text{A}/\mu\text{s}$	--	27	--	ns
$t_{rr}$	Reverse Recovery Time	$V_R=600\text{V}$ , $I_F=30\text{A}$	--	55	--	ns
$I_{RRM}$	Max. Reverse Recovery Current	$di_F/dt=-200\text{A}/\mu\text{s}$ , $T_J=25^{\circ}\text{C}$	--	3.5	--	A
$t_{rr}$	Reverse Recovery Time	$V_R=600\text{V}$ , $I_F=30\text{A}$	--	290	--	ns
$I_{RRM}$	Max. Reverse Recovery Current	$di_F/dt=-200\text{A}/\mu\text{s}$ , $T_J=125^{\circ}\text{C}$	--	8.5	--	A

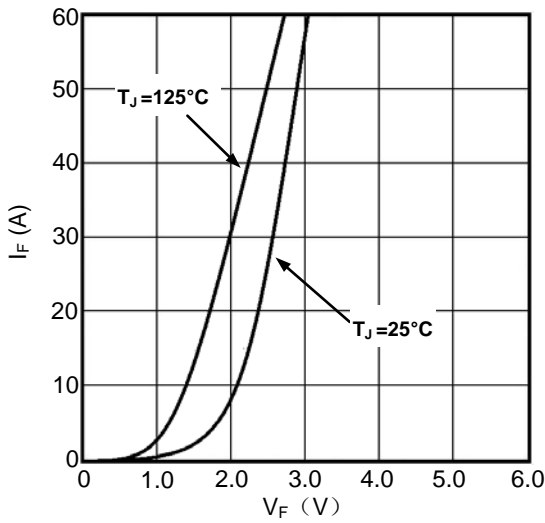

Fig1. Forward Voltage Drop vs Forward Current

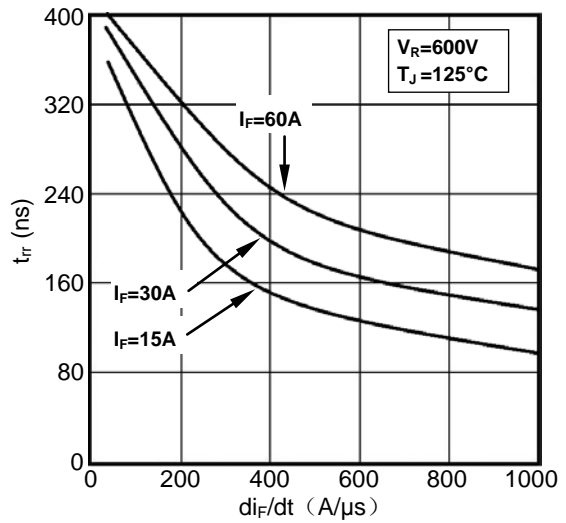

Fig2. Reverse Recovery Time vs  $di_F/dt$

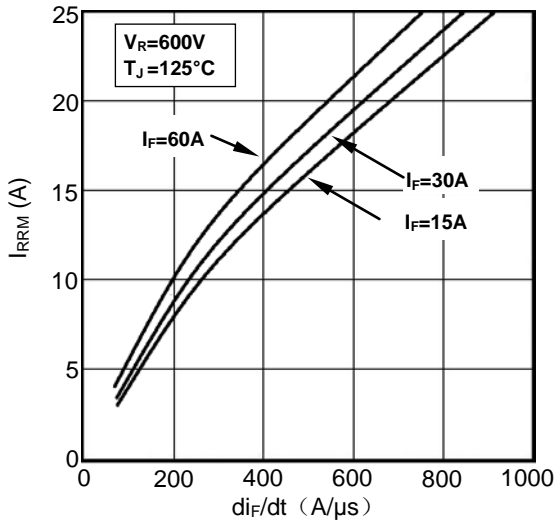

Fig3. Reverse Recovery Current vs  $di_F/dt$

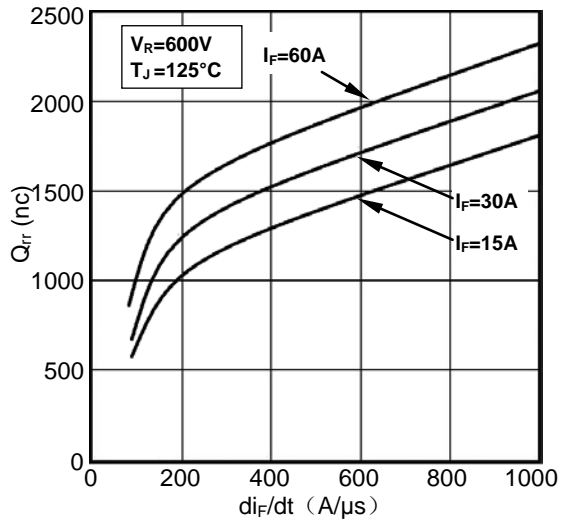

Fig4. Reverse Recovery Charge vs  $di_F/dt$

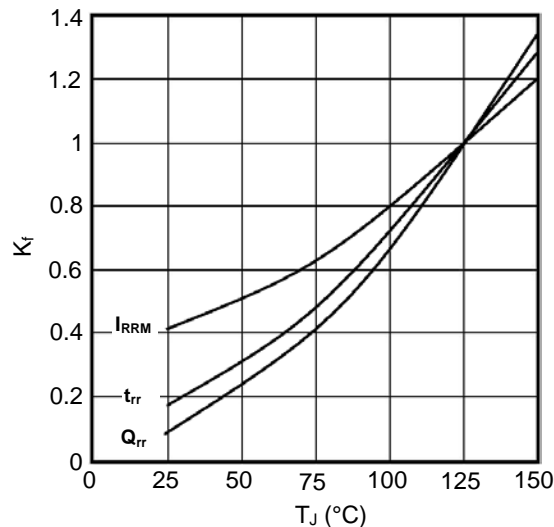

Fig5. Dynamic Parameters vs Junction Temperature

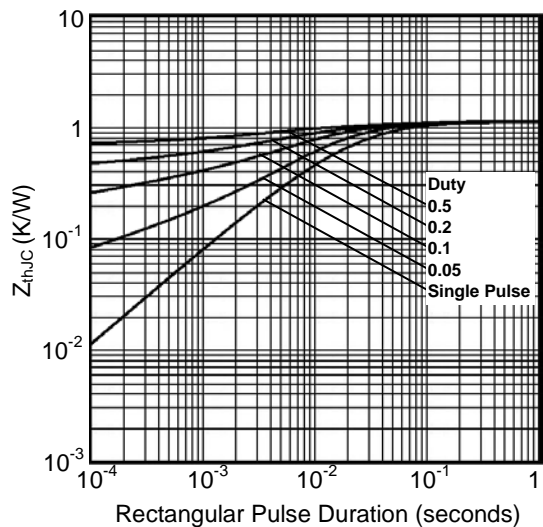

Fig6. Transient Thermal Impedance

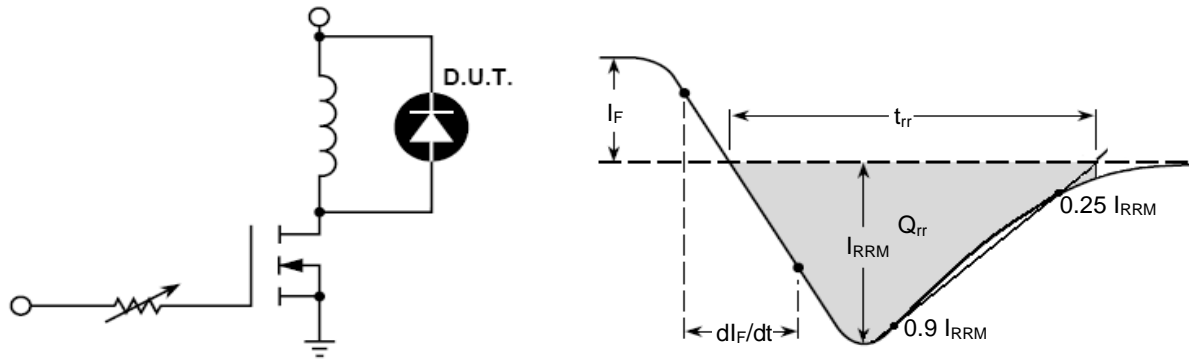
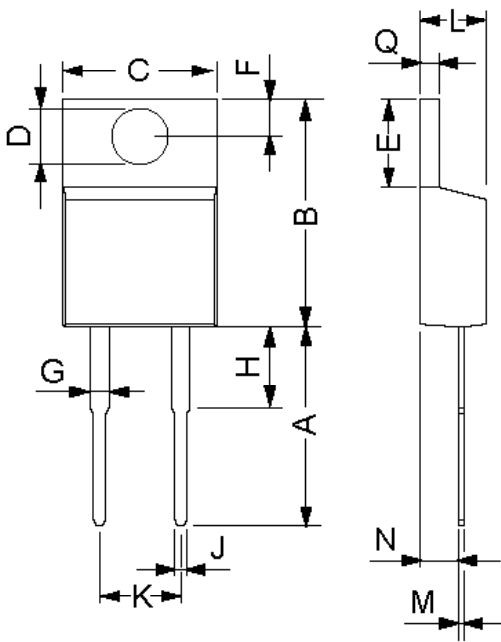

Fig7. Diode Reverse Recovery Test Circuit and Waveform

Dimensions TO-220AC



Dim.	Millimeter		Inches	
	Min.	Max.	Min.	Max.
A	12.7	14.73	0.5	0.58
B	14.23	16.51	0.56	0.65
C	9.66	10.66	0.38	0.42
D	3.54	4.08	0.139	0.161
E	5.85	6.85	2.3	0.42
F	2.54	3.42	0.1	0.135
G	1.15	1.77	0.045	0.07
H	-	6.35	-	0.25
J	0.64	0.89	0.025	0.035
K	4.83	5.33	0.19	0.21
L	3.56	4.82	0.14	0.19
M	0.51	0.76	0.02	0.03
N	2.04	2.49	0.08	0.115
Q	0.64	1.39	0.025	0.055