

N- and P-Channel Complementary, 20V,MOSFET

V _{DS} (V)	Typical R _{DS(on)} (Ω)
N-Channel 20	0.034 @ V _{GS} =4.5V
	0.041 @ V _{GS} =2.5V
	0.050 @ V _{GS} =1.8V
P-Channel -20	0.083 @ V _{GS} = -4.5V
	0.110 @ V _{GS} = -2.5V
	0.145 @ V _{GS} = -1.8V



SOT-23-6L

Descriptions

The WCM2064 is the N-Channel and P-Channel enhancement MOS Field Effect Transistor as a single package for DC-DC converter or level shift applications, uses advanced trench technology and design to provide excellent R_{DS(ON)} with low gate charge. Standard Product WCM2064 is Pb-free and Halogen-free.

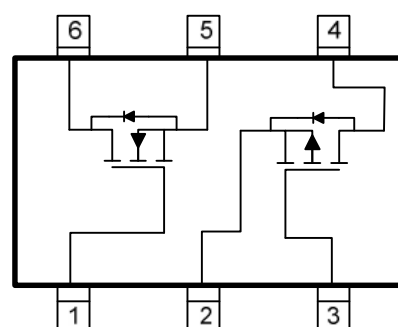

Pin configuration (Top View)

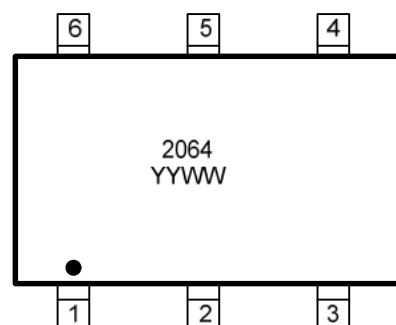

2064 = Device Code

YYWW= Date Code

Marking

Features

- Trench Technology
- Supper high density cell design
- Excellent ON resistance
- Extremely Low Threshold Voltage
- Small package SOT-23-6L

Applications

- Driver: Relays, Solenoids, Lamps, Hammers
- Power supply converters circuit
- Load/Power Switching for portable device

Order Information

Device	Package	Shipping
WCM2064-6/TR	SOT-23-6L	3000/Tape&Reel

Absolute Maximum Ratings ($T_A=25^{\circ}\text{C}$ unless otherwise noted)

Symbol	Parameter	N-Channel	P-Channel	Unit	
V_{DSS}	Drain-to-Source Voltage	20	-20	V	
V_{GSS}	Gate-to-Source Voltage	± 8	± 8	V	
I_D	Continuous Drain Current ^{a d}	$T_A=25^{\circ}\text{C}$	4.4	-2.8	A
		$T_A=70^{\circ}\text{C}$	3.5	-2.2	
I_{DM}	Pulsed Drain Current ^c	16	-10	A	
P_D	Power Dissipation ^{a d}	$T_A=25^{\circ}\text{C}$	0.72		W
		$T_A=70^{\circ}\text{C}$	0.46		
T_J	Operation junction temperature	-55~150		$^{\circ}\text{C}$	
T_{stg}	Storage temperature range	-55~150		$^{\circ}\text{C}$	

Thermal Resistance Ratings ($T_A=25^{\circ}\text{C}$ unless otherwise noted)

Parameter		Symbol	Typical	Maximum	Unit
Junction-to-Ambient Thermal Resistance ^a	$t \leq 10$ s	$R_{\theta JA}$	74	92	$^{\circ}\text{C}/\text{W}$
	Steady State		115	143	
Junction-to-Ambient Thermal Resistance ^b	$t \leq 10$ s	$R_{\theta JA}$	90	112	
	Steady State		138	172	
Junction-to-Case Thermal Resistance	Steady State	$R_{\theta JC}$	63	78	

a Surface mounted on FR4 Board using 1 square inch pad size, 1oz copper

b Surface mounted on FR4 board using minimum pad size, 1oz copper

c Pulse width < 380 μs , Duty Cycle < 2%

d Maximum junction temperature $T_J=150^{\circ}\text{C}$.

Electronics Characteristics (T_A=25°C unless otherwise noted)

Symbol	Parameter	Test Condition	Min	Typ.	Max	Unit		
Off Characteristics								
V _{(BR)DSS}	Drain-Source Breakdown Voltage	V _{GS} =0V, I _D =250uA	N-Ch	20		V		
		V _{GS} =0V, I _D =-250uA	P-Ch	-20				
I _{DSS}	Zero Gate Voltage Drain Current	V _{DS} =16V, V _{GS} =0V	N-Ch		1	uA		
		V _{DS} =-16V, V _{GS} =0V	P-Ch		-1			
I _{GSS}	Gate –Source leakage current	V _{DS} =0V, V _{GS} =±8V	N-Ch		±1	uA		
			P-Ch		±1			
ON Characteristics								
V _{GS(th)}	Gate Threshold Voltage	V _{DS} = V _{GS} , I _D =250uA	N-Ch		0.65	1.0	V	
		V _{DS} = V _{GS} , I _D =-250uA	P-Ch		-0.70	-1.0		
R _{DS(on)}	Drain-Source On-Resistance	V _{GS} =4.5V, I _D =3.4A	N-Ch		34	46	mΩ	
			P-Ch		83	116		
			N-Ch		41	69		
			P-Ch		110	160		
Dynamic Characteristics								
C _{iss}	Input Capacitance	Nmos: V _{DS} =10V, V _{GS} =0V, F=1MHz Pmos: V _{DS} =-10V, V _{GS} =0V, f=1MHz	N-Ch		529		pF	
			P-Ch		531			
C _{oss}	Output Capacitance		N-Ch		62			
			P-Ch		61			
C _{rss}	Reverse Transfer Capacitance		N-Ch		57			
			P-Ch		54			
Q _{G(TOT)}	Total Gate Charge	Nmos: V _{DD} =10V, V _{GS} =4.5V, I _D =3.4A Pmos: V _{DD} =-10V, V _{GS} =-4.5V I _D =-2.8A	N-Ch		7.35		nC	
			P-Ch		8.1			
Q _{G(TH)}	Threshold gate charge		N-Ch		0.75			
			P-Ch		0.82			
Q _{GS}	Gate-Source Charge		N-Ch		1.6			
			P-Ch		1.8			
Q _{GD}	Gate-Drain Charge		N-Ch		1.35			
			P-Ch		1.1			
td(on)	Turn-On Delay Time	Nmos: V _{DD} =10V, V _{GS} =4.5V, I _D =1.0A, R _G =6Ω Pmos: V _{DD} =-10V, I _D =-1.2A, V _{GS} =-4.5V, R _G =6Ω	N-Ch		18.6		ns	
			P-Ch		21.6			
tr	Turn-On Rise Time		N-Ch		8.2			
			P-Ch		8.6			
td(off)	Turn-Off Delay Time		N-Ch		55			
			P-Ch		58			
tf	Turn-Off Fall Time		N-Ch		7.6			
			P-Ch		8.4			
BODY DIODE CHARACTERISTICS								
Forward Voltage	V _{SD}		V _{GS} = 0 V, I _S = 1.0A	N-Ch		0.7		1.5
		V _{GS} = 0 V, I _S = -1.0A	P-Ch		-0.8	-1.5		

Typical Characteristics (N-Channel $T_A=25\text{ }^\circ\text{C}$, unless otherwise noted)

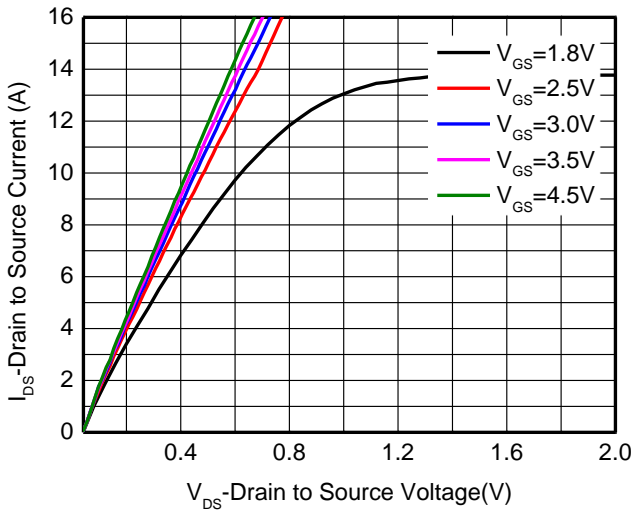

Output Characteristics

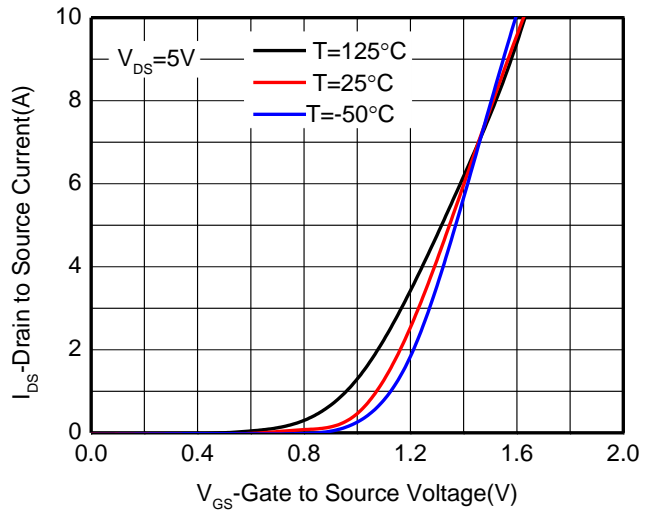

Transfer Characteristics

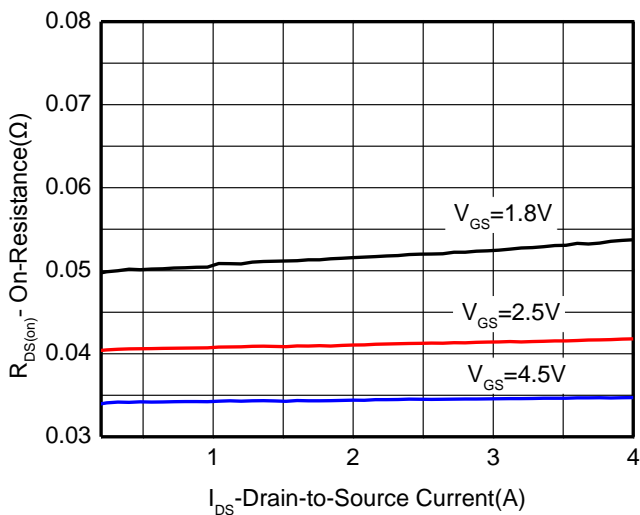

On-Resistance vs. Drain Current

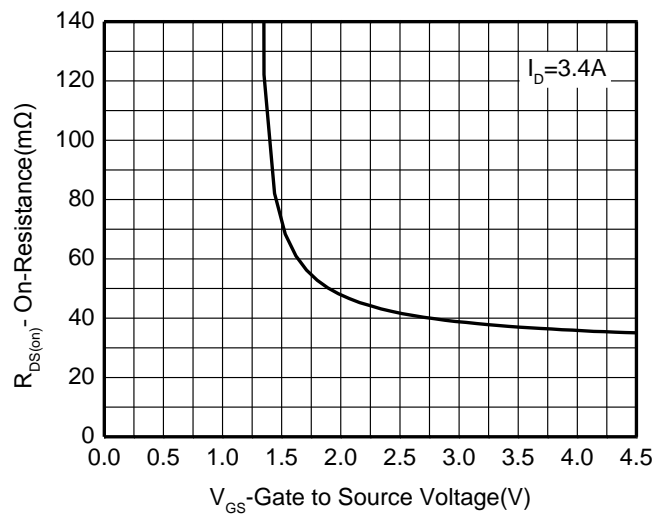

On-Resistance vs. Gate-to-Source Voltage

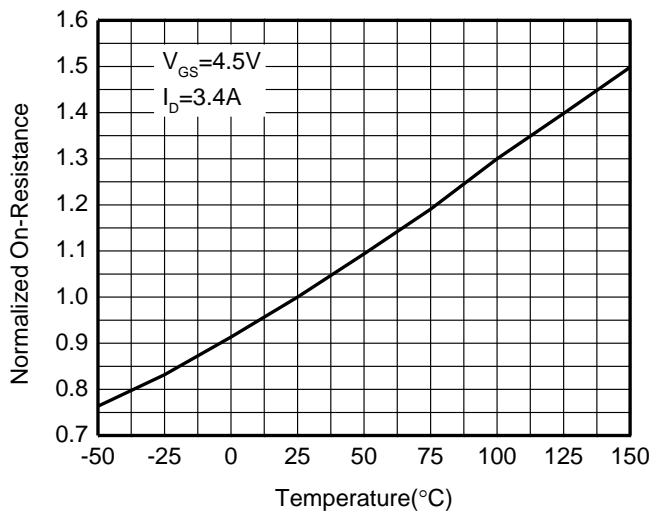

On-Resistance vs. Junction Temperature

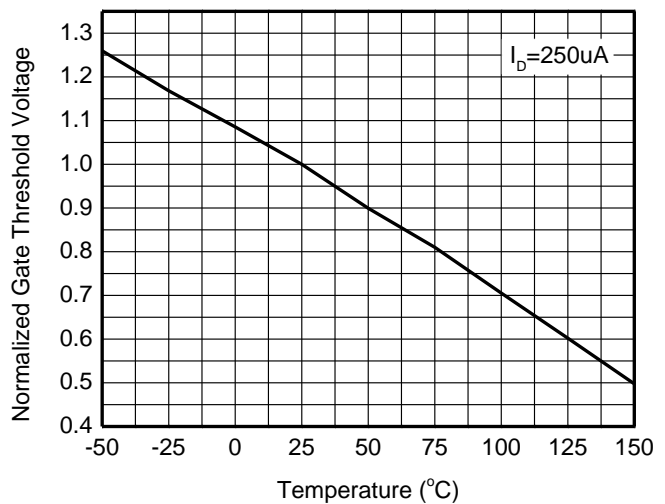

Threshold Voltage vs. Temperature

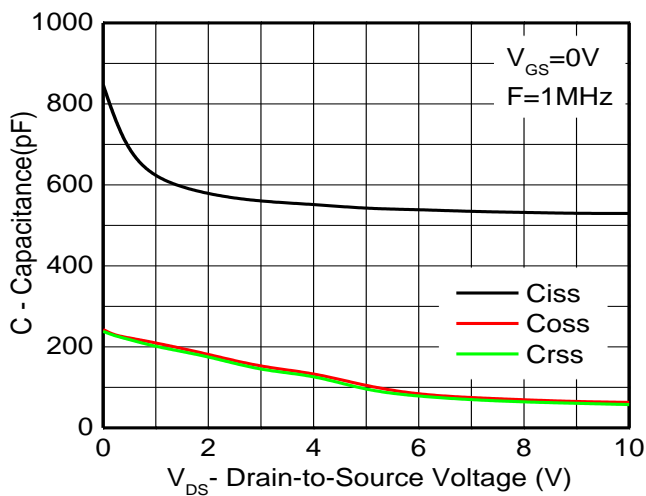

Capacitance

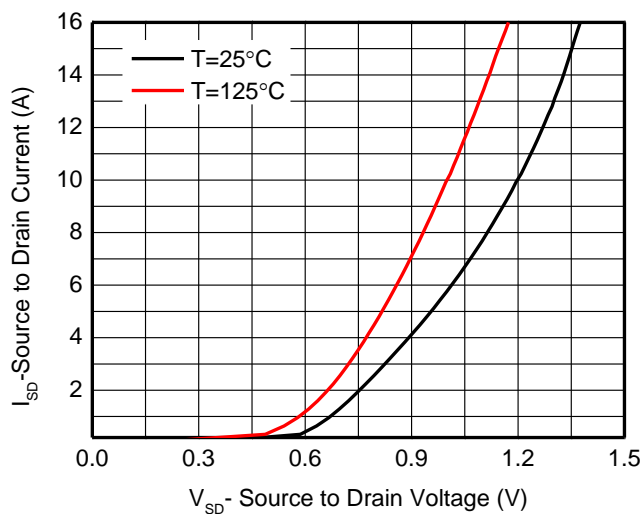

Body Diode Forward Voltage

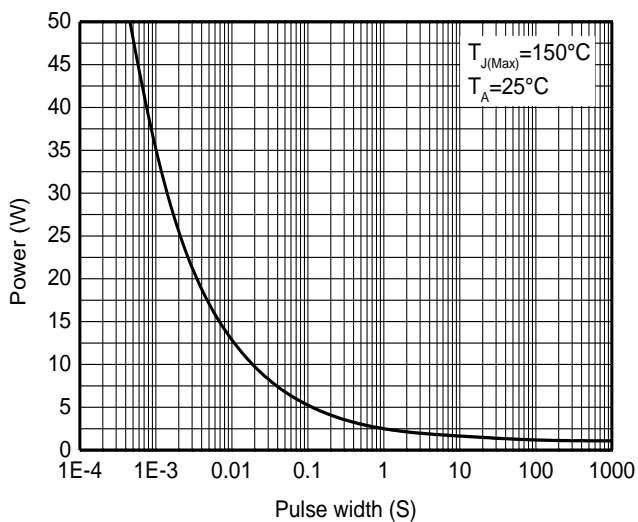

Single pulse power

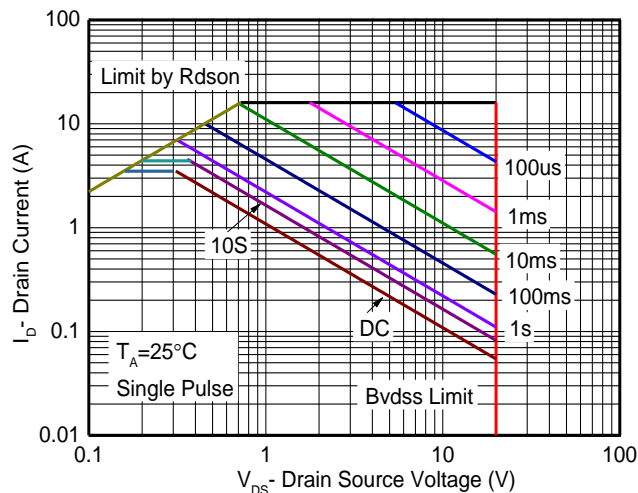

Safe operating power

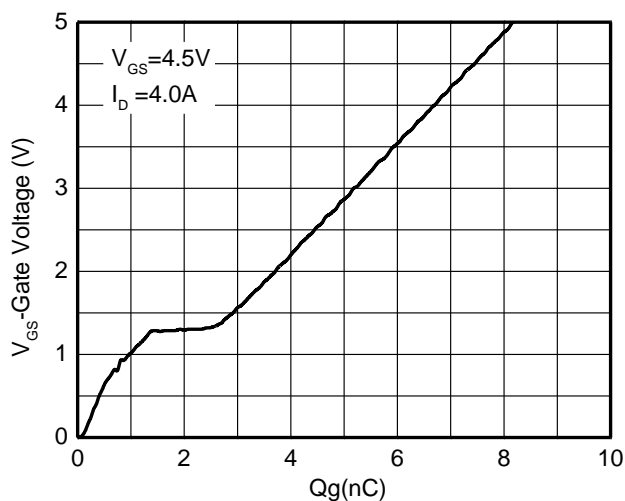

Gate charge Characteristics

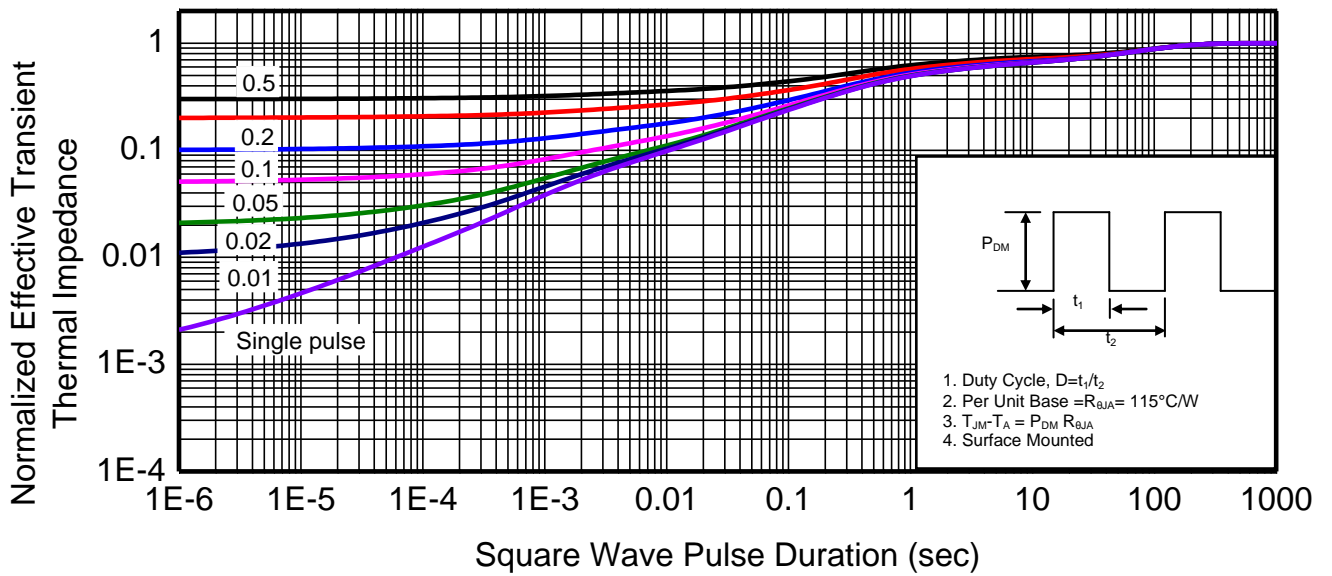

Transient thermal response (Junction-to-Ambient)

Typical Characteristics (P-Channel $T_A=25^\circ\text{C}$, unless otherwise noted)

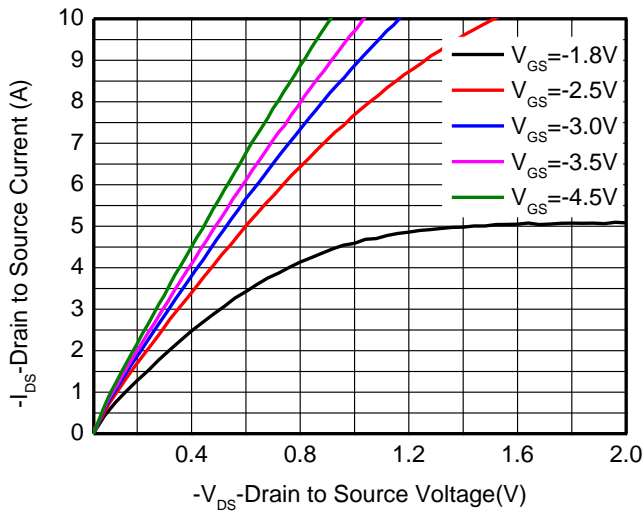

Output characteristics

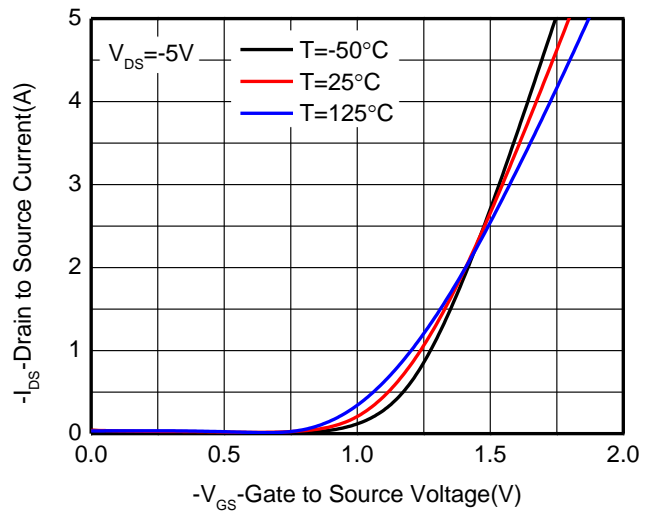

Transfer characteristics

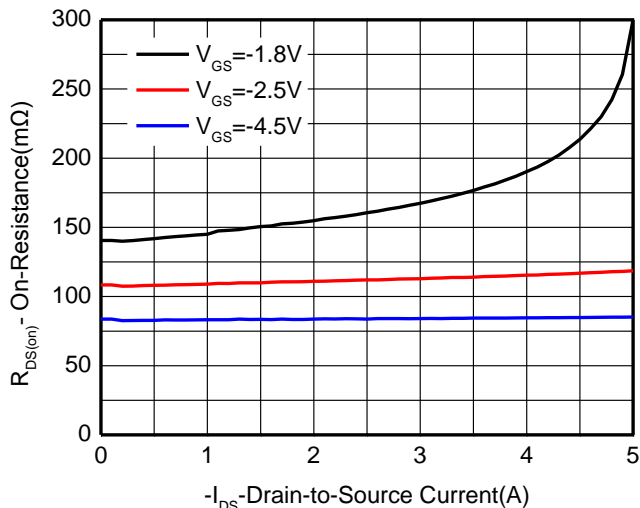

On-Resistance vs. Drain current

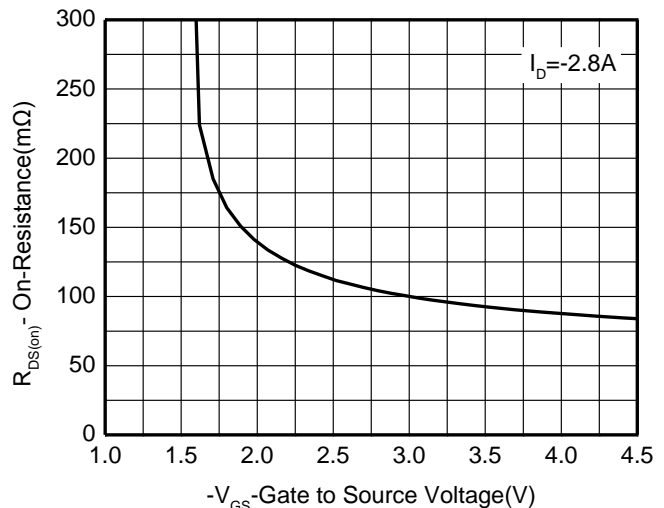

On-Resistance vs. Gate-to-Source voltage

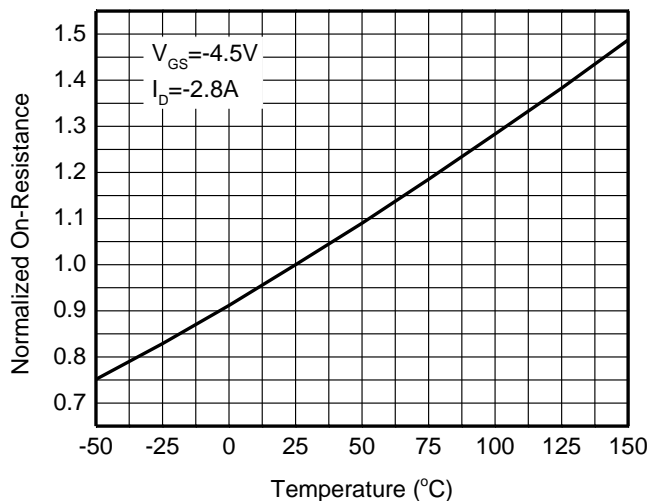

On-Resistance vs. Junction temperature

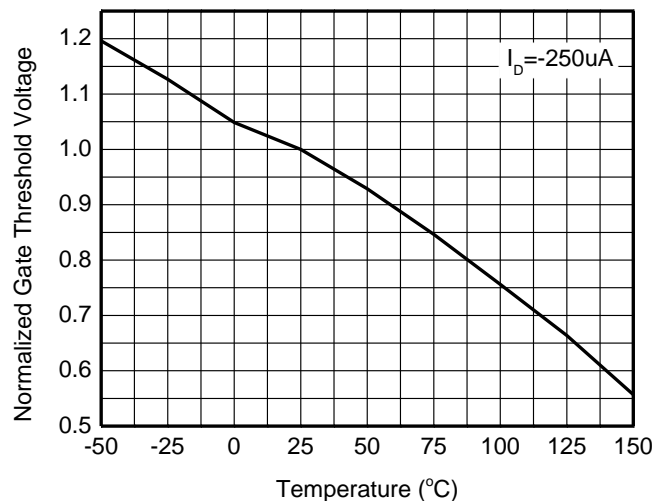

Threshold voltage vs. Temperature

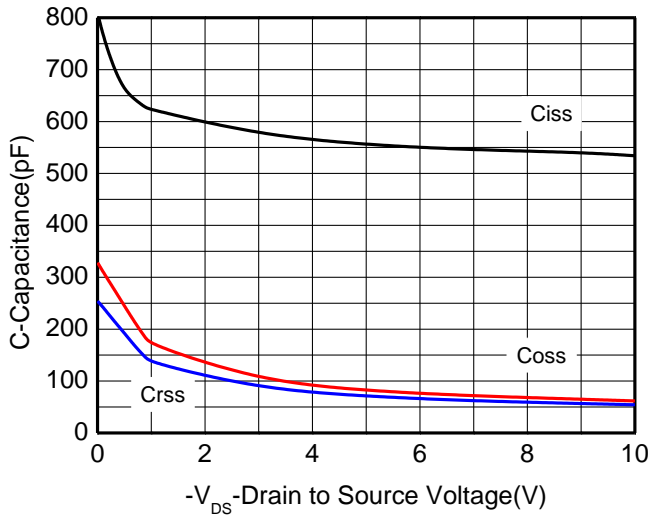

Capacitor

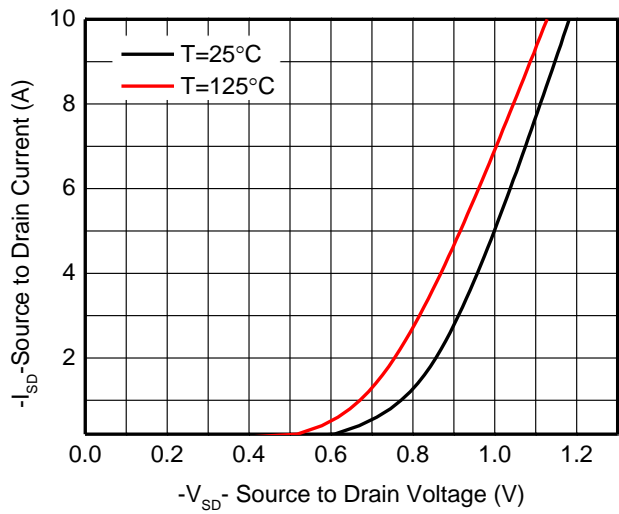

Body diode forward voltage

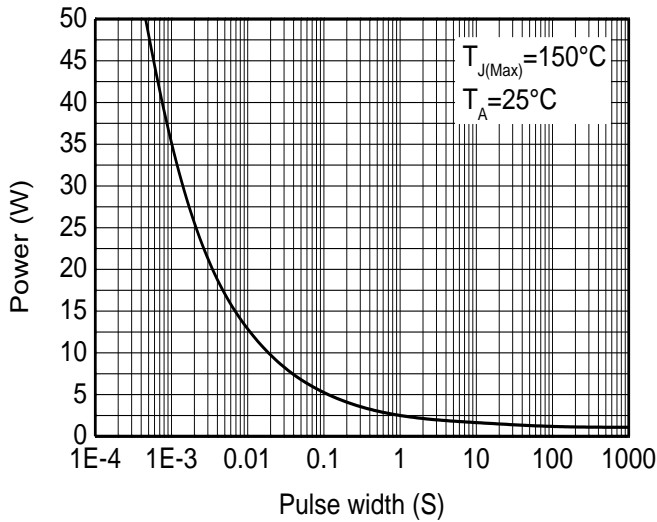

Single pulse power (Junction-to-ambient)

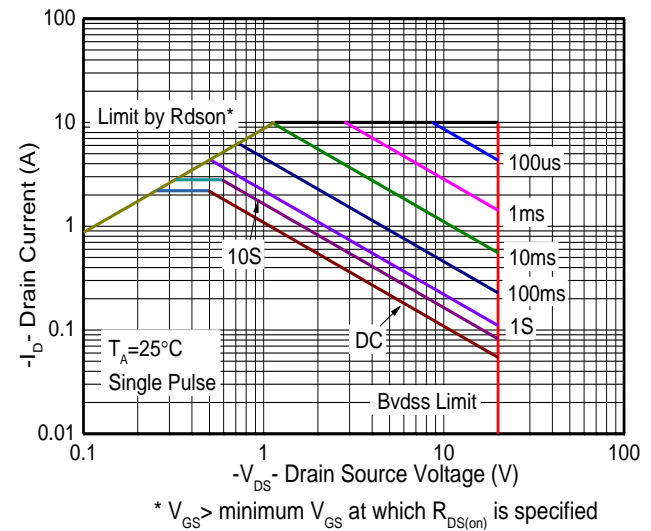

Safe operating power

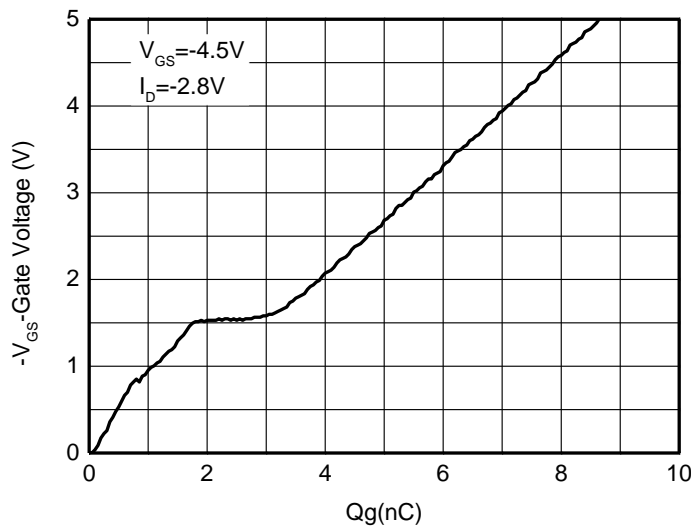

Gate charge Characteristics

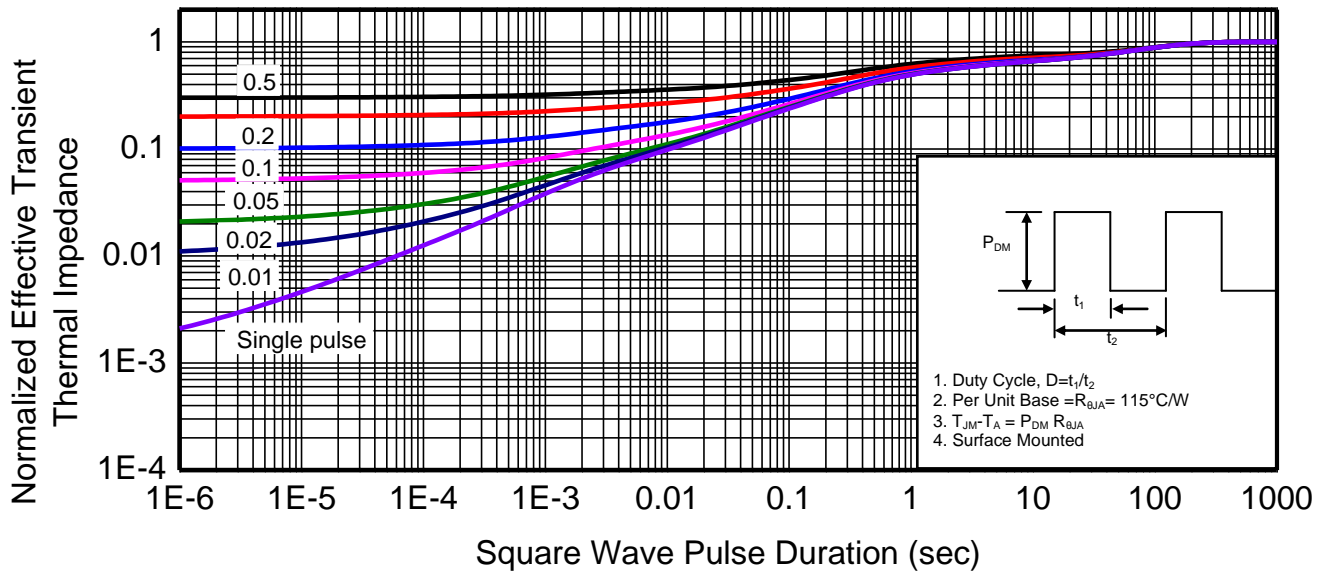

Transient thermal response (Junction-to-Ambient)

Package Outline Dimension

SOT-23-6L

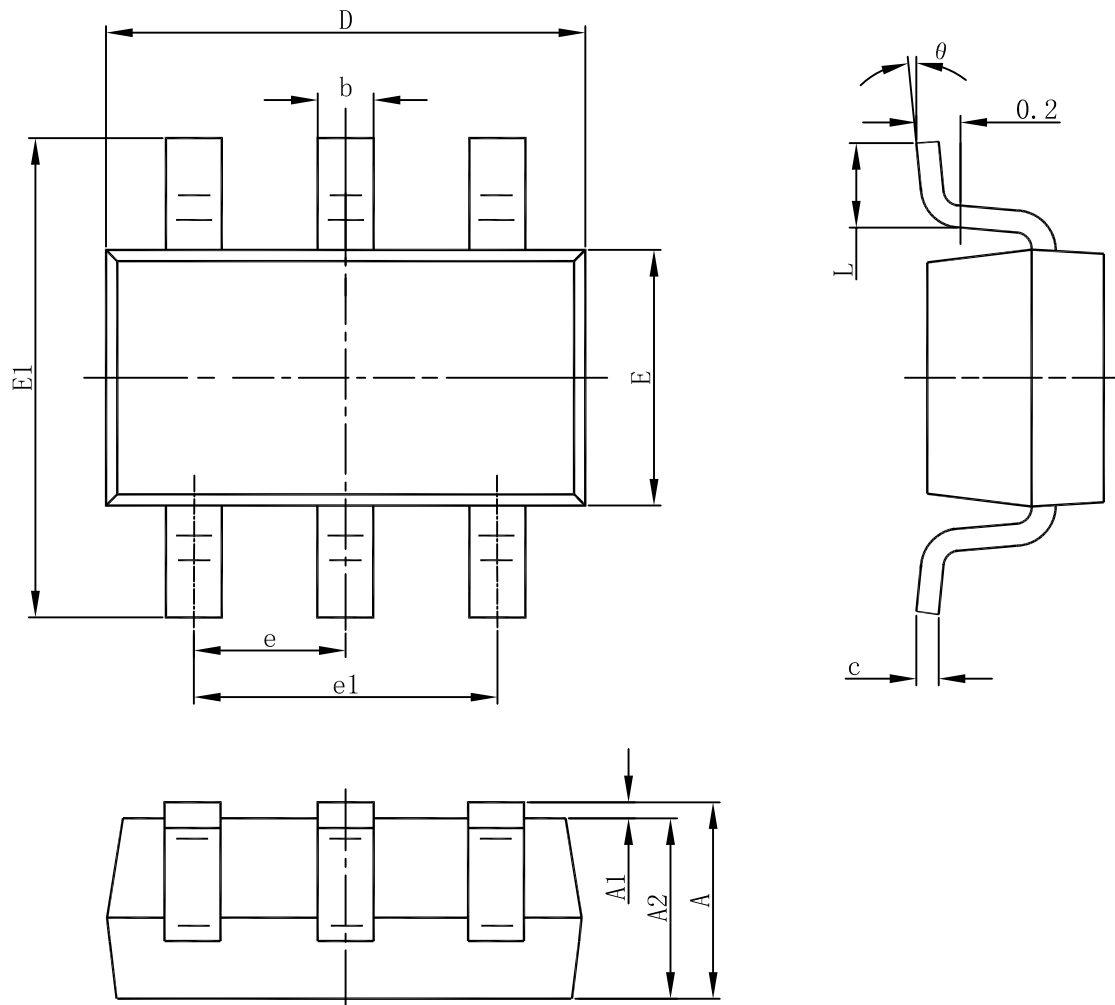

Symbol	Dimensions In Millimeters		Dimensions In Inches	
	Min	Max	Min	Max
A	1.050	1.250	0.041	0.049
A1	0.000	0.100	0.000	0.004
A2	1.050	1.150	0.041	0.045
b	0.300	0.500	0.012	0.020
c	0.100	0.200	0.004	0.008
D	2.820	3.020	0.111	0.119
E	1.500	1.700	0.059	0.067
E1	2.650	2.950	0.104	0.116
e	0.950(BSC)		0.037(BSC)	
e1	1.800	2.000	0.071	0.079
L	0.300	0.600	0.012	0.024
θ	0°	8°	0°	8°