

Applications

- Test Equipment
- Electronic Warfare
- Military Radar

Product Features

- Frequency Range: 2 - 18 GHz
- Pout: > 37 dBm at $P_{IN} = 23$ dBm
- PAE: > 20 % at $P_{in} = 23$ dBm
- Large Signal Gain ($P_{in} = 23$ dBm): > 14 dB
- Small Signal Gain: > 22 dB
- Return Loss: > 7 dB
- Bias: $V_D = 22$ V, $I_{DQ} = 450$ mA, $V_G = -2.3$ V Typical
- Chip Dimensions: 3 x 5 x 0.10 mm
- Performance under CW operation

General Description

TriQuint's TGA2214 is a wideband power amplifier fabricated on TriQuint's TQGaN15 GaN on SiC process. The TGA2214 operates from 2 – 18 GHz and achieves 5 W of saturated output power with 14 dB of large signal gain and greater than 20% power-added efficiency .

This combination of wideband power, gain and efficiency provides system designers the flexibility to improve system performance while reducing size and cost.

The TGA2214 is matched to 50 Ω with integrated DC blocking capacitors on both RF ports simplifying system integration; it is ideally suited for electronic warfare, test instrumentation and radar applications across both military and commercial markets.

Lead free and RoHS compliant.

Evaluation Boards are available upon request.

Functional Block Diagram

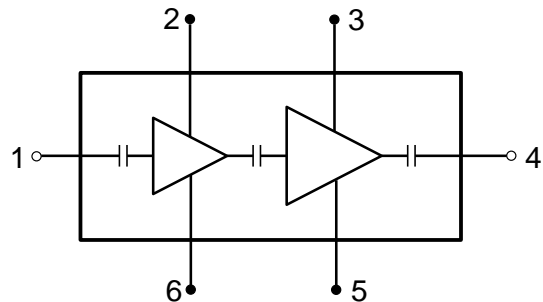

Pad Configuration

Pad No.	Symbol
1	RF _{IN}
2	V _{G1}
3	V _{G2}
4	RF _{OUT}
5	V _{D2}
6	V _{D1}

Ordering Information

Part	ECCN	Description
TGA2214	3A001.b.2.c	2 - 18 GHz 5W GaN Power Amplifier

Absolute Maximum Ratings

Parameter	Value
Drain Voltage (V_D)	23 V
Gate Voltage Range (V_G)	-5 to 0 V
Drain Current	
- 1 st Stage (I_{D1})	0.5 A
- 2 nd Stage (I_{D2})	1.0 A
Gate Current at $T_{ch} = 200\text{ }^\circ\text{C}$	
- 1 st Stage (I_{G1})	85 $^\circ\text{C}$: -1.0 to 7 mA
- 2 nd Stage (I_{G2})	85 $^\circ\text{C}$: -2.6 to 24 mA
Power Dissipation (P_{DISS}), 85 $^\circ\text{C}$	30 W
Input Power, CW, 50 Ω , 85 $^\circ\text{C}$ (P_{IN})	31 dBm
Input Power, CW, VSWR 3:1, 85 $^\circ\text{C}$ (P_{IN})	31 dBm
Channel Temperature (T_{CH})	275 $^\circ\text{C}$
Mounting Temperature (30 Seconds)	320 $^\circ\text{C}$
Storage Temperature	-55 to 150 $^\circ\text{C}$

Operation of this device outside the parameter ranges given above may cause permanent damage. These are stress ratings only, and functional operation of the device at these conditions is not implied.

Recommended Operating Conditions

Parameter	Value
Drain Voltage (V_D) CW	22 V
Drain Current (I_{DQ})	450 mA
Drain Current Under RF Drive (I_{D_DRIVE})	See plots p. 7
Gate Voltage (V_G)	-2.3 V (Typ.)
Gate Current Under RF Drive (I_{G_DRIVE})	See plots p. 7
Temperature (T_{BASE})	-40 to 85 $^\circ\text{C}$

Electrical specifications are measured at specified test conditions. Specifications are not guaranteed over all recommended operating conditions.

Electrical Specifications

Test conditions unless otherwise noted: 25 $^\circ\text{C}$, $V_D = 22\text{ V}$, $I_{DQ} = 450\text{ mA}$, $V_G = -2.3\text{ V Typ. CW}$.

Parameter	Min	Typical	Max	Units
Operational Frequency Range	2		18	GHz
Small Signal Gain		> 22		dB
Input Return Loss		> 7		dB
Output Return Loss		> 8		dB
Output Power @ $P_{in} = 23\text{ dBm}$		> 37		dBm
Power Added Efficiency @ $P_{in} = 23\text{ dBm}$		> 20		%
Large Signal Gain @ $P_{in} = 23\text{ dBm}$		> 14		dB
IM3 ($P_{out}/\text{tone} = 31\text{ dBm/Tone}$, 100 Mz spacing)		-20		dBc
IM5 ($P_{out}/\text{tone} = 31\text{ dBm/Tone}$, 100 Mz spacing)		-33		dBc
Small Signal Gain Temperature Coefficient		-0.04		dB/ $^\circ\text{C}$
Output Power Temperature Coefficient		-0.008		dBm/ $^\circ\text{C}$
Recommended Operating Voltage		22	22	V

Thermal and Reliability Information

Parameter	Test Conditions	Value	Units
Thermal Resistance (θ_{JC}) ⁽¹⁾	$T_{BASE} = 85^{\circ}C, V_D = 22 V$ (CW)	7	$^{\circ}C/W$
Channel Temperature (T_{CH}) (Under RF drive)	At Freq = 9.5 GHz, $P_{IN} = 23$ dBm: $I_{DQ} = 450$ mA, $I_{D_Drive} = 1.28$ A	232	$^{\circ}C$
Median Lifetime (T_M)	$P_{OUT} = 38.5$ dBm, $P_{DISS} = 21$ W	5.0E+7	Hrs

Notes:

1. Thermal resistance measured to back of carrier plate. MMIC mounted on 20 mils CuMo carrier using 1.5 mil 80/20 AuSn.

Test Conditions: $V_D = 22 V$; Failure Criteria = 10% reduction in I_{D_MAX}

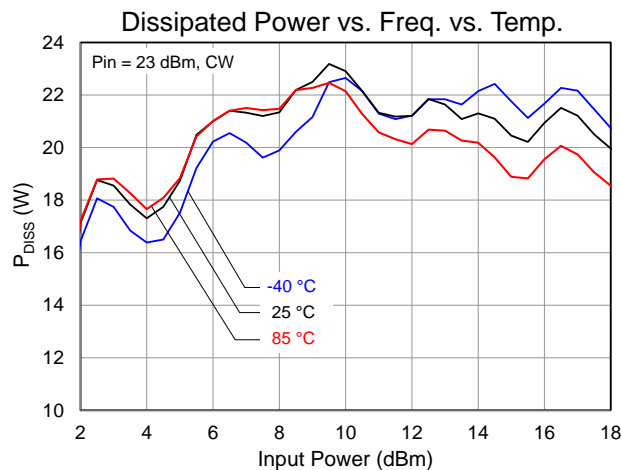
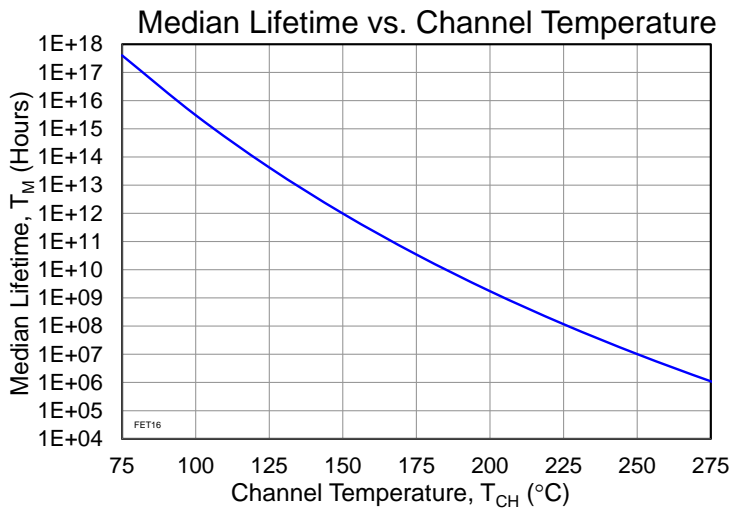

Typical Performance: Small Signal

Conditions unless otherwise specified: $V_D = 22\text{ V}$, $I_{DQ} = 450\text{ mA}$, $V_G = -2.3\text{ V}$, CW.

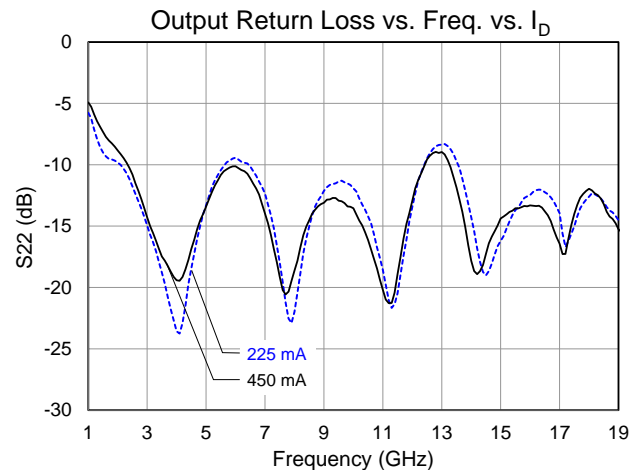
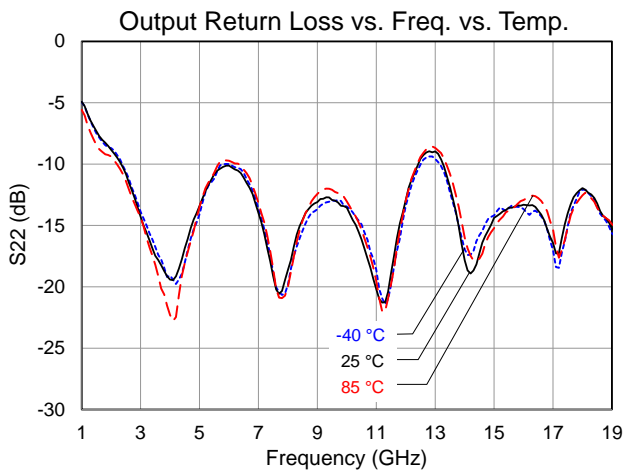
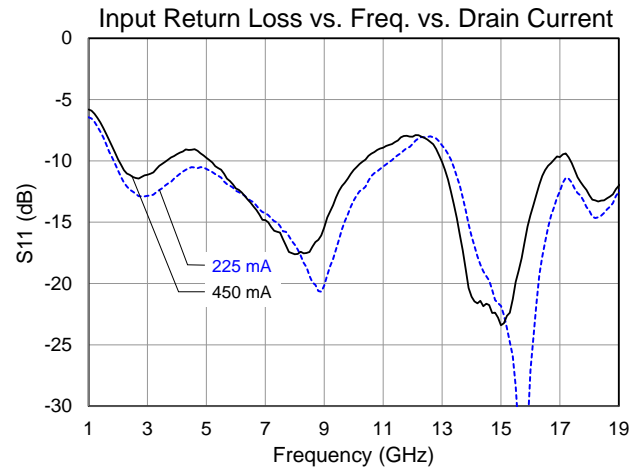
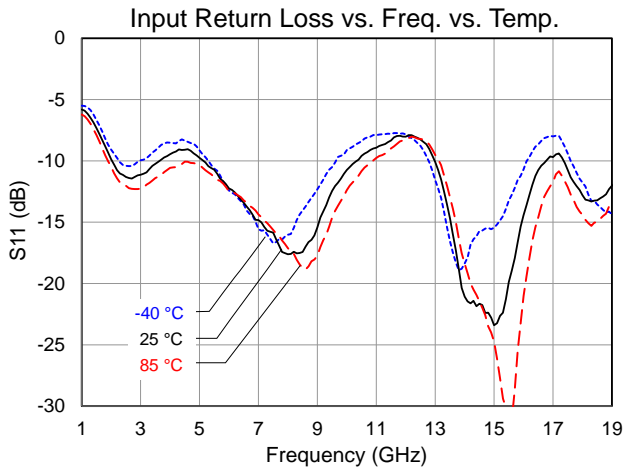
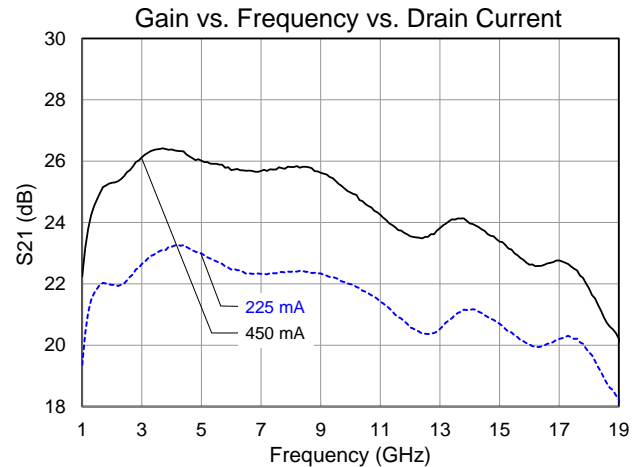
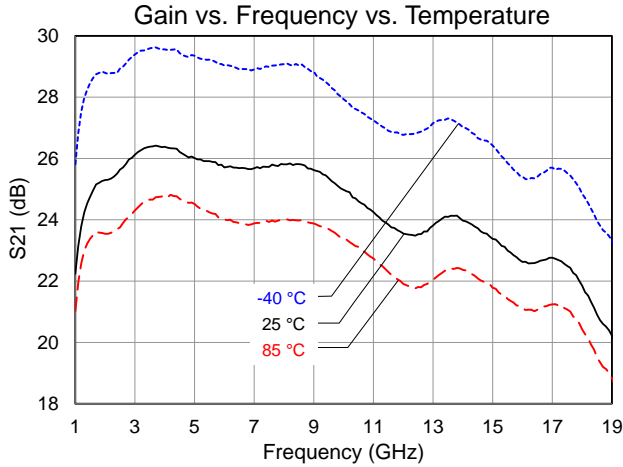

Typical Performance: Large Signal

Conditions unless otherwise specified: $V_D = 22\text{ V}$, $I_{DQ} = 450\text{ mA}$, $V_G = -2.3\text{ V}$, CW.

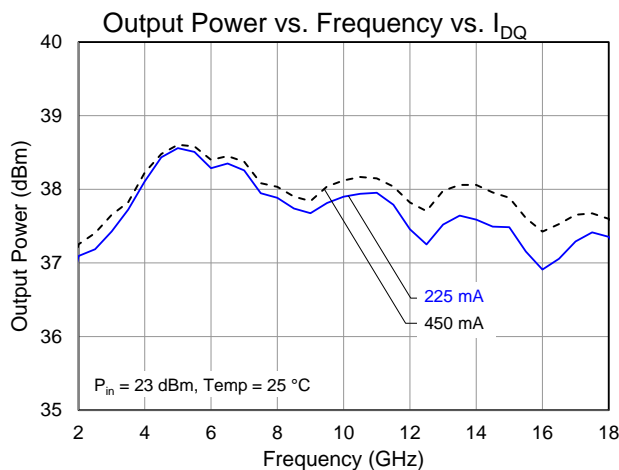
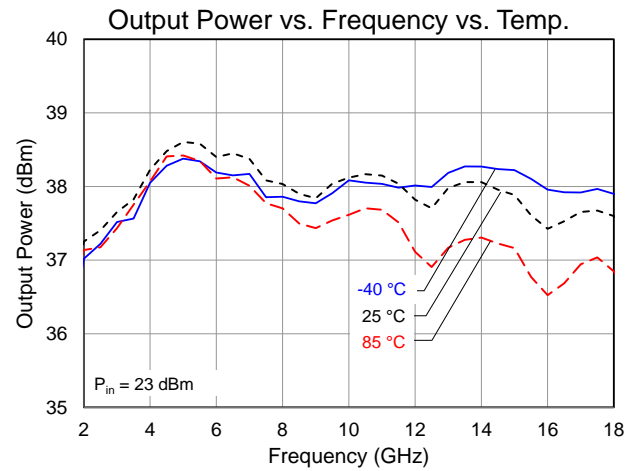
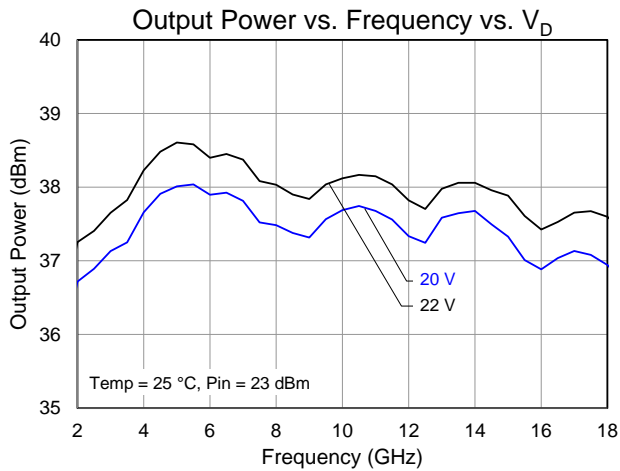
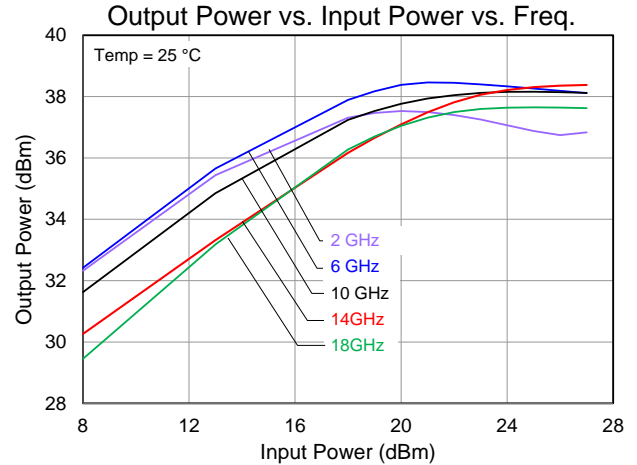
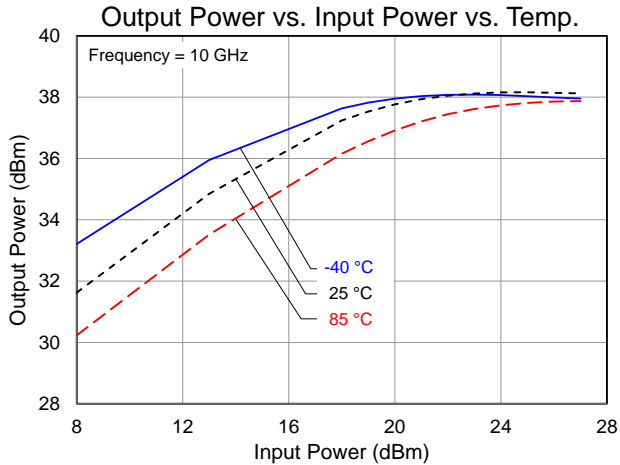

Typical Performance: Large Signal

Conditions unless otherwise specified: $V_D = 22\text{ V}$, $I_{DQ} = 450\text{ mA}$, $V_G = -2.3\text{ V}$, CW.

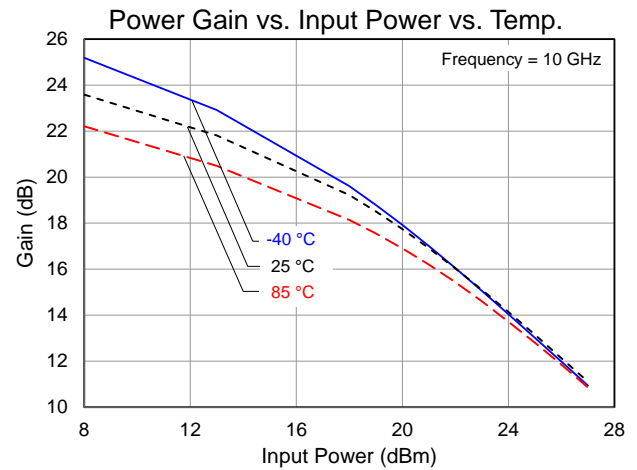
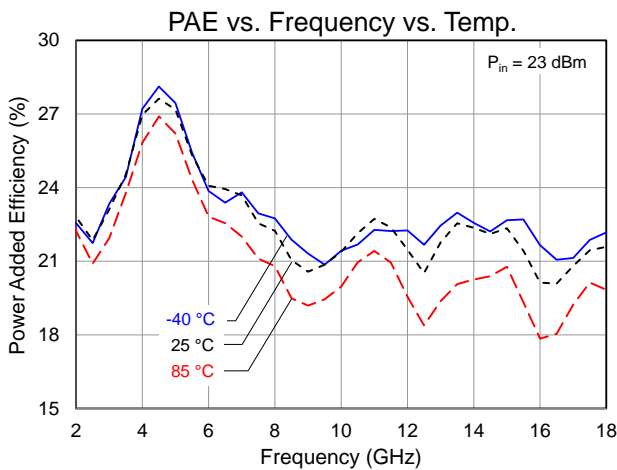
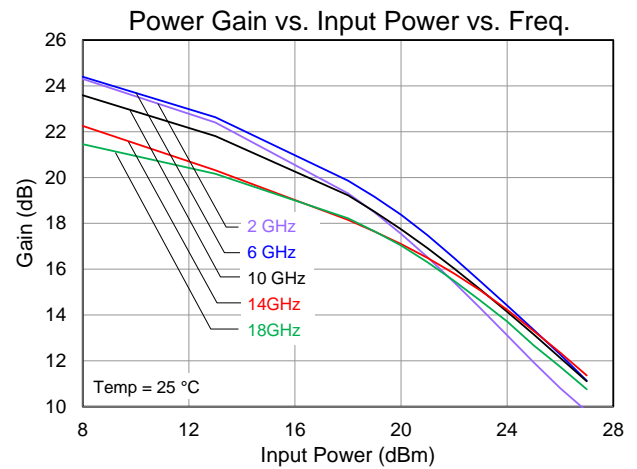
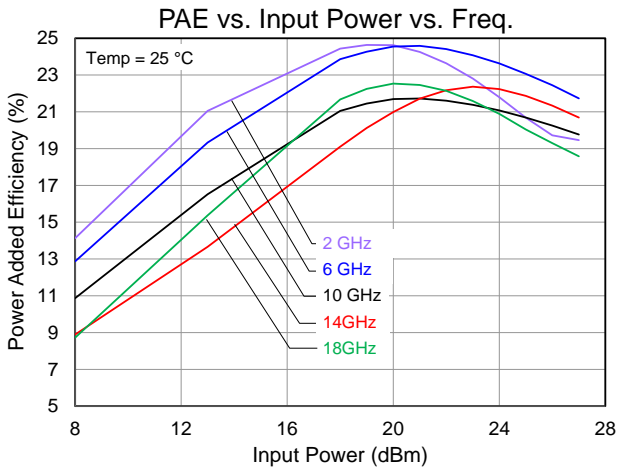
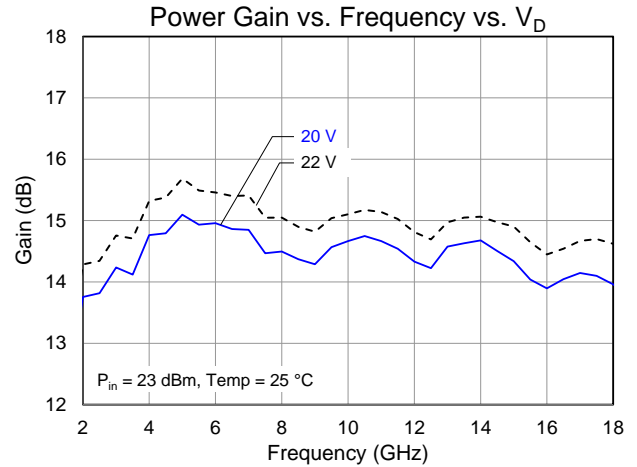
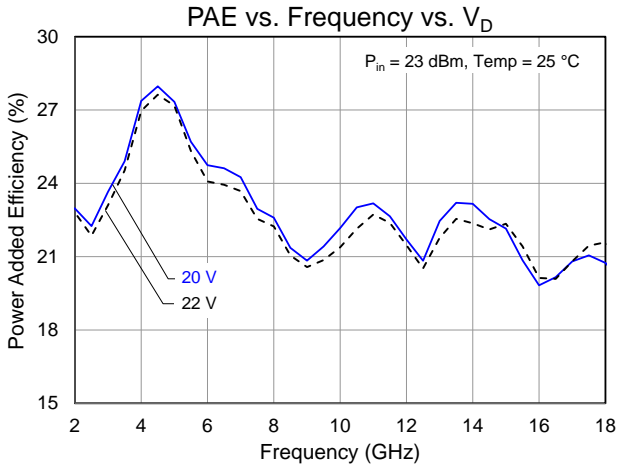

Typical Performance: Large Signal

Conditions unless otherwise specified: $V_D = 22\text{ V}$, $I_{DQ} = 450\text{ mA}$, $V_G = -2.3\text{ V}$, CW.

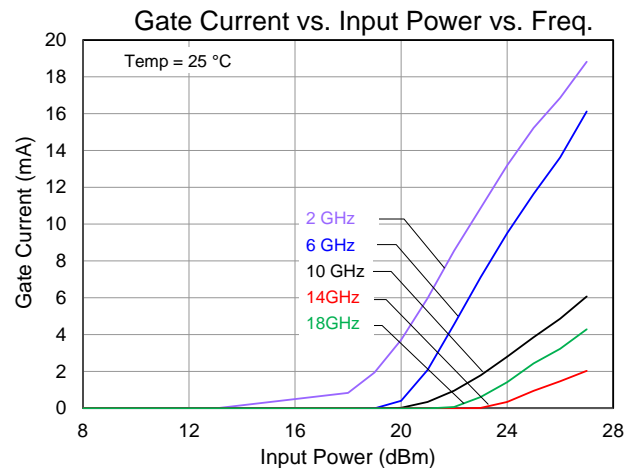
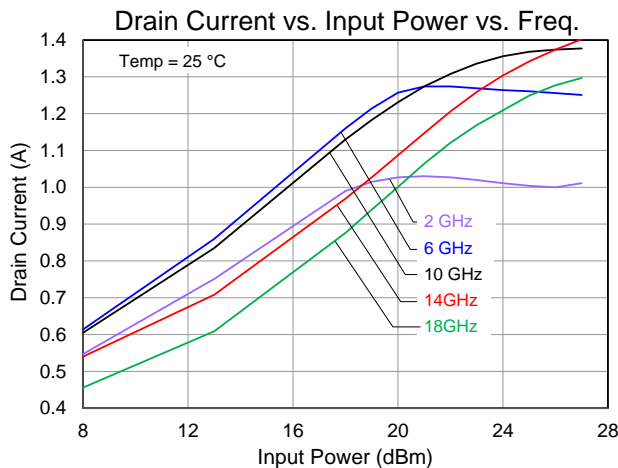
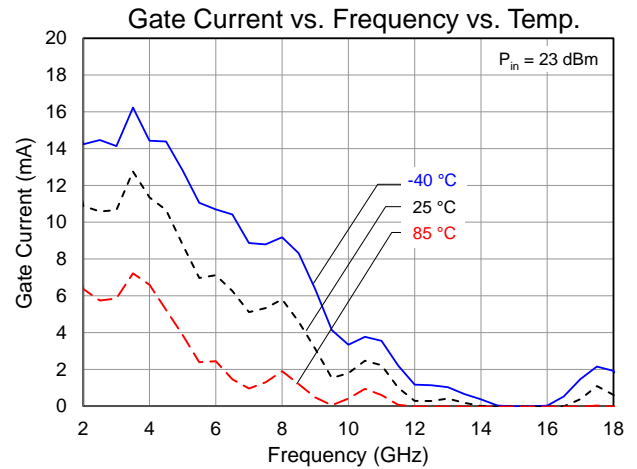
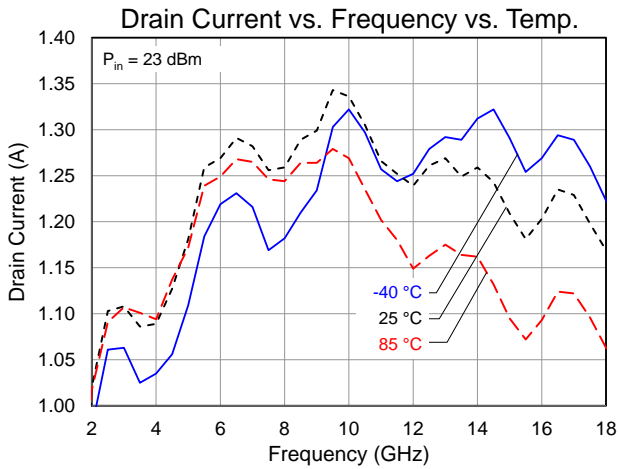
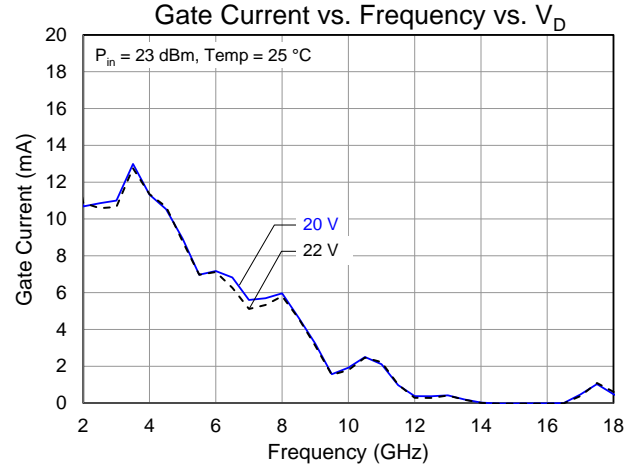
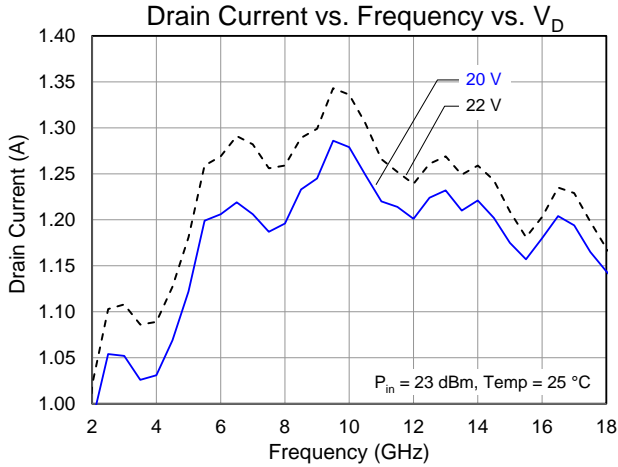

Typical Performance: Large Signal and Linearity

Conditions unless otherwise specified: $V_D = 22\text{ V}$, $I_{DQ} = 450\text{ mA}$, $V_G = -2.3\text{ V}$, CW.

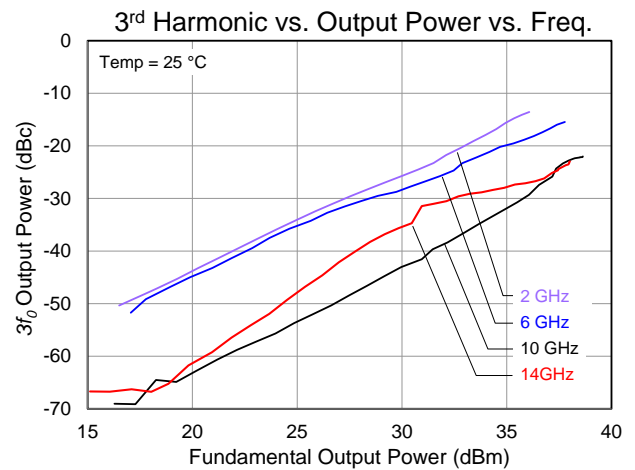
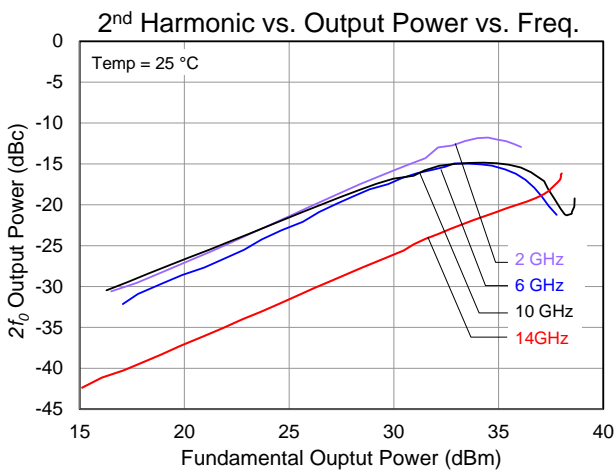
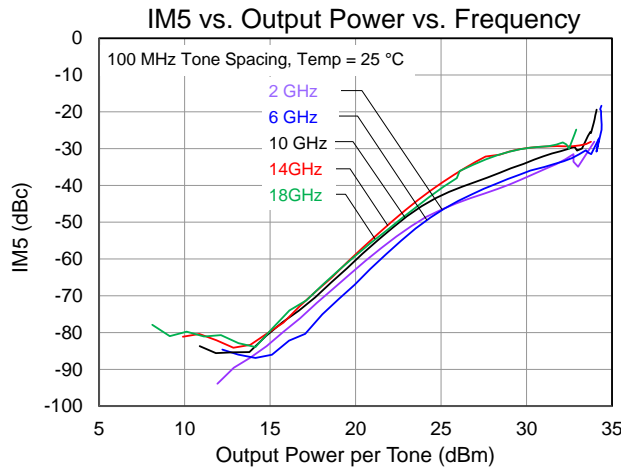
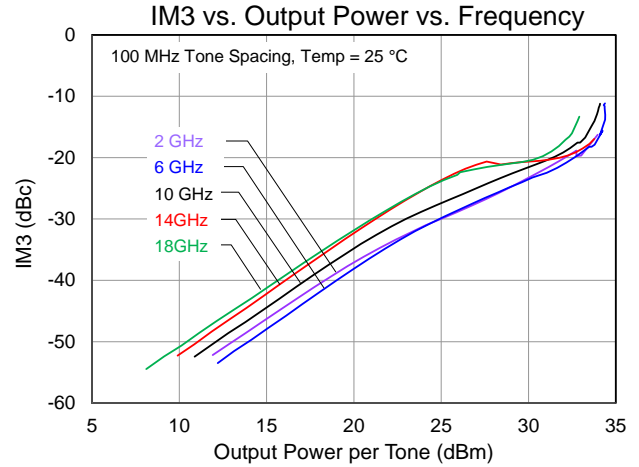
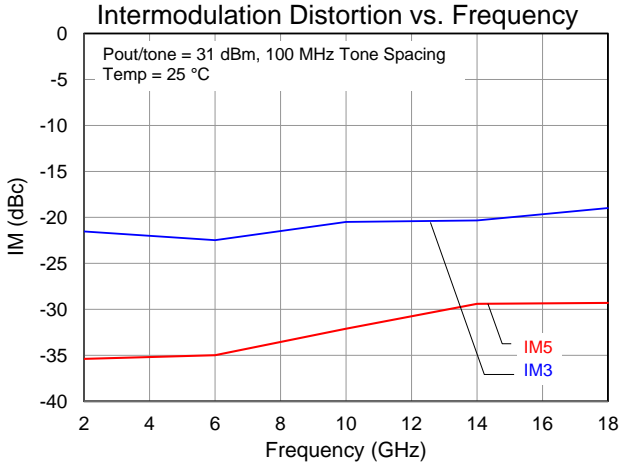

Application Circuit

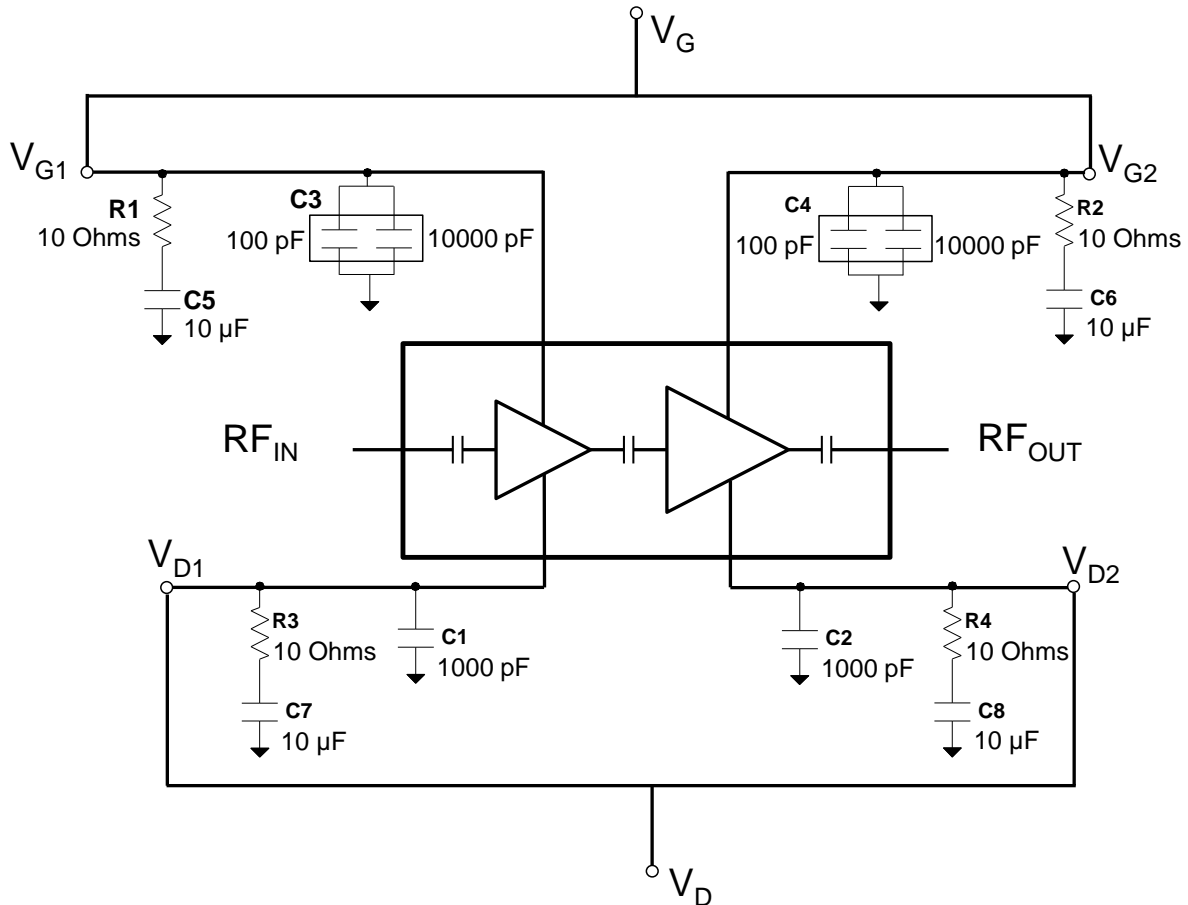

Bias-up Procedure

1. Set I_D limit to 1.4 A, I_G limit to 20 mA
2. Apply -5 V to V_G
3. Apply +22 V to V_D ; ensure I_{DQ} is approx. 0 mA
4. Adjust V_G until $I_{DQ} = 450$ mA ($V_G \sim -2.3$ V Typ.).
5. Turn on RF supply

Bias-down Procedure

1. Turn off RF supply
2. Reduce V_G to -5 V; ensure I_{DQ} is approx. 0 mA
3. Set V_D to 0 V
4. Turn off V_D supply
5. Turn off V_G supply

Assembly Drawing

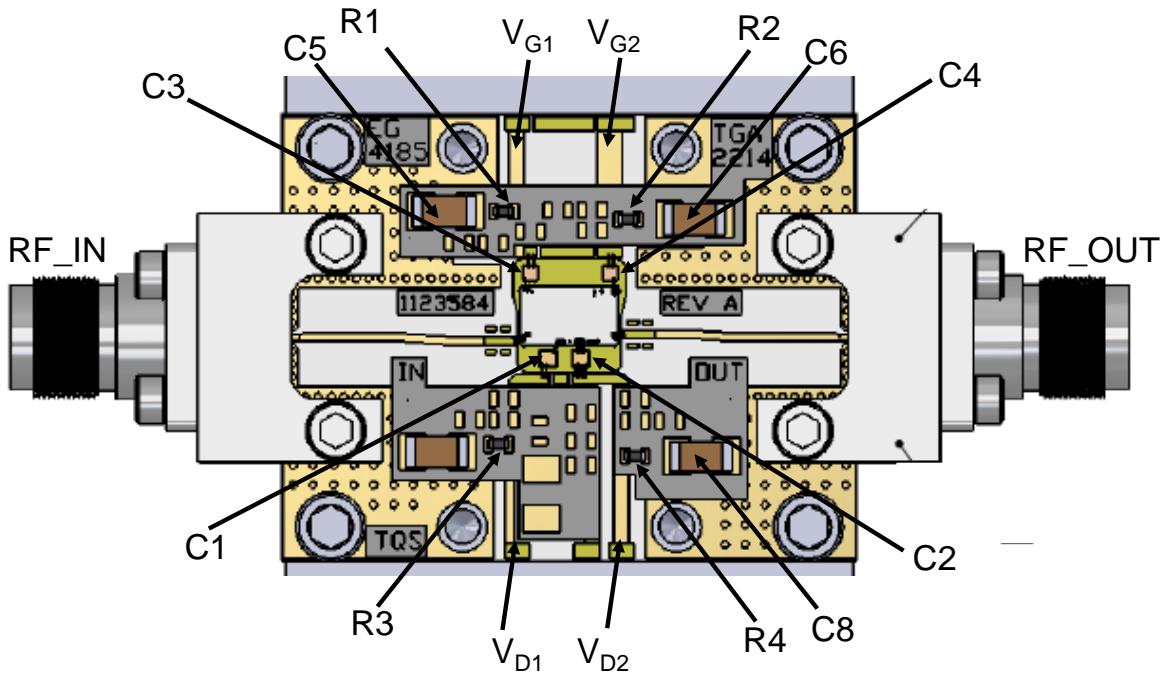

MMIC bonding detail:

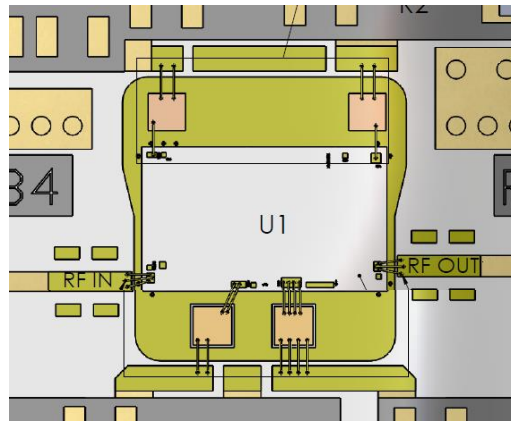

Bill of Material

Reference Des.	Value	Description	Manuf.	Part Number
C1, C2	1000 pF	Cap, 50V, 10%, SLCC	Presidio	MSA3535B102K2H5C-F
C3, C4	100pF // 10000pF	Cap, 50V, 20%, X7R, MLCC	Presidio	MVB3030X103M2H5C1F
C5, C6, C7, C8	10 μ F	Cap, 1206, 20%, 50V, X5R	Various	
R1, R2, R3, R4	10 Ohms	Res, 0402, 5%	Various	

Mechanical Information

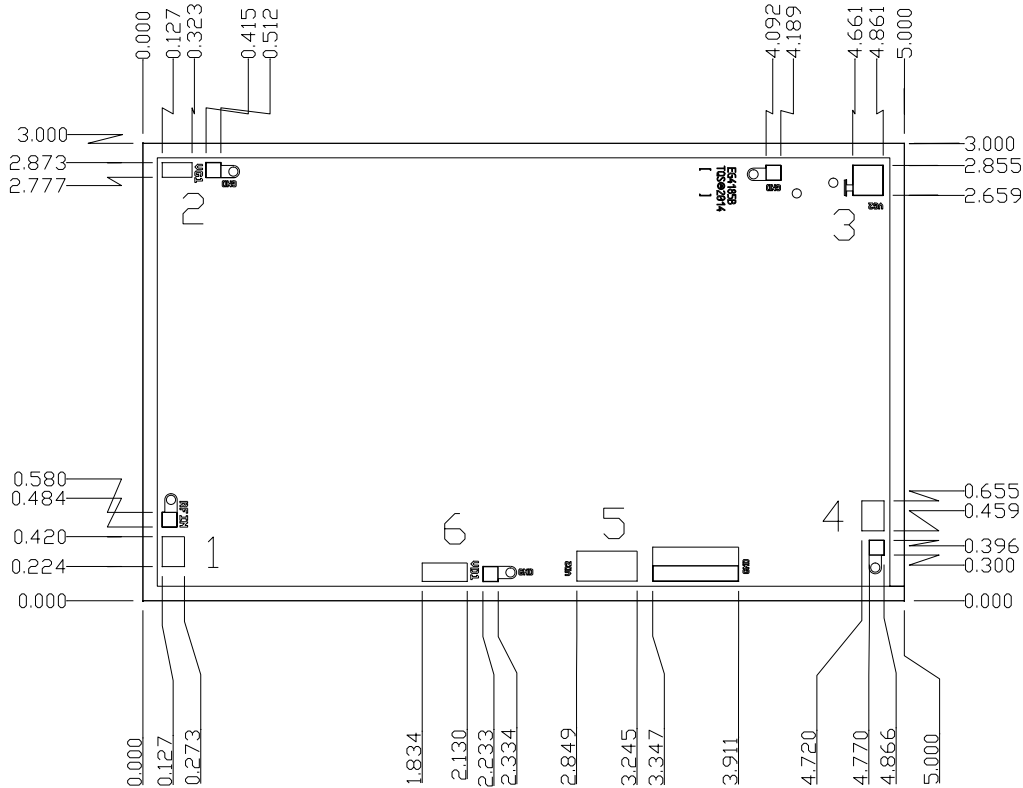

Units: millimeters
 Thickness: 0.10
 Die x,y size tolerance: ± 0.050
 Ground is backside of die

Pad Description

Pad No.	Symbol	Description
1	RF _{IN}	Input; matched to 50 Ω ; DC blocked
2, 3	V _G (1)	Gate Voltage; Bias network is required; see recommended Application Information above.
4	RF _{OUT}	Output; matched to 50 Ω ; DC blocked
5, 6	V _D (2)	Drain voltage; Bias network is required; see recommended Application Information above.

Notes:

1. Pads 2 & 3 may be tied together off-chip.
2. Pads 5 & 6 may be tied together off-chip.

Assembly Notes

Component placement and adhesive attachment assembly notes:

- Vacuum pencils and/or vacuum collets are the preferred method of pick up.
- Air bridges must be avoided during placement.
- The force impact is critical during auto placement.
- Organic attachment (i.e. epoxy) can be used in low-power applications.
- Curing should be done in a convection oven; proper exhaust is a safety concern.

Reflow process assembly notes:

- Use AuSn (80/20) solder and limit exposure to temperatures above 300°C to 3-4 minutes, maximum.
- An alloy station or conveyor furnace with reducing atmosphere should be used.
- Do not use any kind of flux.
- Coefficient of thermal expansion matching is critical for long-term reliability.
- Devices must be stored in a dry nitrogen atmosphere.

Interconnect process assembly notes:

- Thermosonic ball bonding is the preferred interconnect technique.
- Force, time, and ultrasonic are critical parameters.
- Aluminum wire should not be used.
- Devices with small pad sizes should be bonded with 0.0007-inch wire.

Product Compliance Information**ESD Sensitivity Ratings**

Caution! ESD-Sensitive Device

ESD Rating: TBD
Value: TBD
Test: Human Body Model (HBM)
Standard: JEDEC Standard JESD22-A114

ECCN

US Department of Commerce: 3A001.b.2.c

Solderability

Use AuSn (80/20) solder and limit exposure to temperatures above 300°C to 3-4 minutes, maximum.

RoHS Compliance

This part is compliant with EU 2002/95/EC RoHS directive (Restrictions on the Use of Certain Hazardous Substances in Electrical and Electronic Equipment).

This product also has the following attributes:

- Lead Free
- Halogen Free (Chlorine, Bromine)
- Antimony Free
- TBBP-A (C₁₅H₁₂Br₄O₂) Free
- PFOS Free
- SVHC Free

Contact Information

For the latest specifications, additional product information, worldwide sales and distribution locations, and information about TriQuint:

Web: www.triquint.com
Email: info-sales@triquint.com

Tel: +1.972.994.8465
Fax: +1.972.994.8504

For technical questions and application information: Email: info-products@triquint.com

Important Notice

The information contained herein is believed to be reliable. TriQuint makes no warranties regarding the information contained herein. TriQuint assumes no responsibility or liability whatsoever for any of the information contained herein. TriQuint assumes no responsibility or liability whatsoever for the use of the information contained herein. The information contained herein is provided "AS IS, WHERE IS" and with all faults, and the entire risk associated with such information is entirely with the user. All information contained herein is subject to change without notice. Customers should obtain and verify the latest relevant information before placing orders for TriQuint products. The information contained herein or any use of such information does not grant, explicitly or implicitly, to any party any patent rights, licenses, or any other intellectual property rights, whether with regard to such information itself or anything described by such information.

TriQuint products are not warranted or authorized for use as critical components in medical, life-saving, or life-sustaining applications, or other applications where a failure would reasonably be expected to cause severe personal injury or death.