



60W WIDE-RANGE POWER SUPPLY FOR LCD MONITOR OR TV, USING THE L5991

by Claudio Spini

This document describes a reference design for a 60W Switch Mode Power Supply dedicated to LCD TV sets or monitors. The board accepts full range input voltage (90 to 265Vrms) and delivers 5V and 12V. It has good efficiency and very good standby performance, able to meet the most stringent standby rules.

Introduction

The LCD monitors and TVs are growing very fast, so to support this kind of applications, a dedicated reference design has been developed, taking into account all the requirements that are needed.

The proposed reference design can supply an LCD monitor or an LCD-TV as well, up to 22" panels, together with multimedia functions like audio. The SMPS accepts a full range input voltage and delivers 2 output voltages, a 5V dedicated to the scaler and μ P, and a 12V dedicated to the backlight and audio. The required standby power consumption is 0.8W at 230Vac, in order to satisfy the worldwide power saving rules. The circuit is also fully protected against faults like output short circuit or over voltage. The market cost pressure has requested a design approach with particular attention to the solution cost. The board technology used is the standard thru-hole, but it can be changed very easily in SMT because most of components are available also in this technology. The circuit has been tested deeply in all the most salient aspects with positive results and it has been integrated with a 22" LCD-TV application without showing any problem.

Main characteristics

INPUT VOLTAGE:	90 ÷ 265 Vrms - 45-66 Hz
OUTPUT VOLTAGES:	5.1V \pm 2% - @2A Dedicated to panel and digital circuitry for scaling 12V \pm 10% - @4A Dedicated to backlight lamp inverters, audio and SCART
STANDBY	Input power less than 0.8W @230Vac, delivering 30mA on 5.1V
FAULT PROTECTIONS:	Short circuit on each output with auto-restart at short removal, Open loop
Safety&EMC:	Safety: Acc. to EN60950, creepage and clearance minimum distance 6.4mm EMC: According to EN50022 Class-B
PCB TYPE & SIZE:	Cu Single Side 70 μ m, CEM-1, 180 x 89 mm

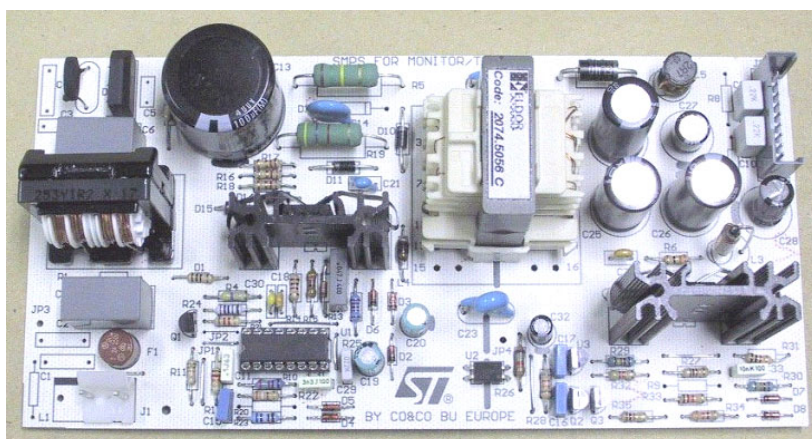

The converter topology of this SMPS is the standard fly back, working in discontinuous and continuous current mode. The operating frequency of the circuit (~50 kHz) has been chosen in order to obtain a compromise between the transformer size and the input filter complexity. Hence, the input EMI filter is a simple Pi-filter, 1-cell only, for differential and common mode noise, using a 4-sectors coil filter. A NTC limits the inrush current at plug-in. The transformer is a slot type, manufactured by PULSE-ELDOR designed according to the EN60950. Ferrite size is ETD34, the reflected voltage is ~95V providing enough room for the leakage inductance voltage spike with still margin for reliability.

The reflected voltage, the switching frequency and the primary inductance have been chosen to allow the continuous current operation of the transformer at full load, all over the input voltage range. This helps to decrease the output capacitor size thanks to the better ratio between the rms and peak current. The network D10, C14, R5 clamps the peak of the leakage inductance voltage spike ensuring reliable operation of the PowerMOS, while C21, D11 and R19 limit the dv/dt of the drain voltage.

The PowerMOS is a low cost STP5NK80ZFP, offering a good trade-off between the $V_{(BR)DSS}$, the $R_{DS(on)}$ and the equivalent C_{OSS} , housed in standard TO-220 or TO-220FP packages. In this design, the TO-220FP (TO-220 insulated) has been used, mounted on a heat sink and fixed by a spring. Core of this design is the current mode primary controller, the L5991 integrating all the required blocks to manage the control and protection of an SMPS. It is available in either DIP-16 (L5991) or in SO-16 (L5991D) packages. The switching frequency is programmable by means of a RC network (R11, R12, C15): during normal operation R11 and R12 are connected in parallel by an internal switch (pin 16); when a light load is detected by the controller this internal switch is opened and the resulting frequency becomes lower, programmed only from C15 and R11.

If the load is further decreased the network D4, D5, R23 provides an additional frequency reduction, proportional to the load, allowing very low power consumption from the mains. Pins 15 and 3 are set in order to allow the full duty-cycle operation and so the use of most of the energy stored in the bulk capacitor during hold-up operations. Because of the current mode control and the possibility for the duty cycle to exceed 50%, a slope compensation circuitry has been added.

A latched, over voltage protection has been implemented by using the pin 14 and a simple resistor network: in case of loop failure the circuit senses the Vcc and, when the voltage at that pin exceeds the internal threshold, the controller stops the operation until its Vcc drops below the UVLO voltage. The start-up is done using a non-dissipative charge pump circuit to save power during standby.

The output rectifiers have been chosen in accordance with the maximum reverse voltage and their power dissipation. The 5V rectifier is Schottky barrier type STPS5L40, a 5A-40V axial rectifier that thanks to the low-forward voltage drop is housed in a DO-201 package.

The 12V rectifier is an STPS8H100, an high voltage Schottky rectifier offering a good trade-off between the forward voltage drop and the maximum operating junction temperature. It is available from STM in 5 different package versions. For this design, the ISOWATT220AC (similar to a standard insulated TO-220) has been used, mounted on a heat sink and fixed by a spring.

On both outputs, an LC filter has been added in order to filter out the high frequency ripple without increasing the output capacitors size or quality. The output voltage regulation is performed by the secondary feedback monitoring the 5.1V output. The feedback network is the typical one that uses a TL431 driving an optocoupler, in this case an SFH617A-2, to ensure the required insulation between primary and secondary. The opto-transistor drives directly the COMP pin of the L5991. Here following some waveforms during the normal operation at full load:

Figure 2. Drain voltage & current @115 V_{AC} - 60Hz - full load

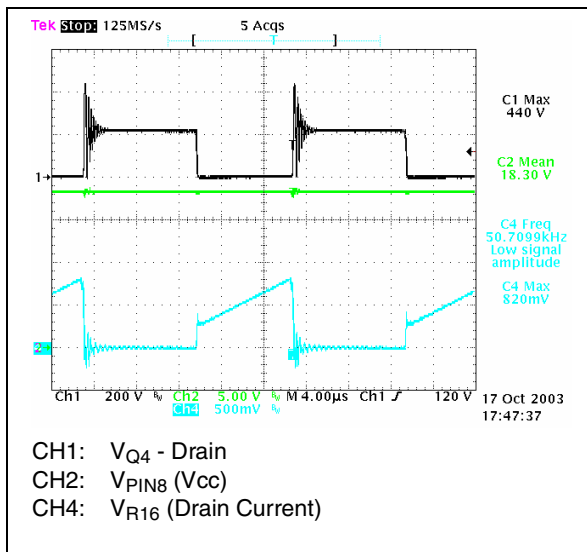
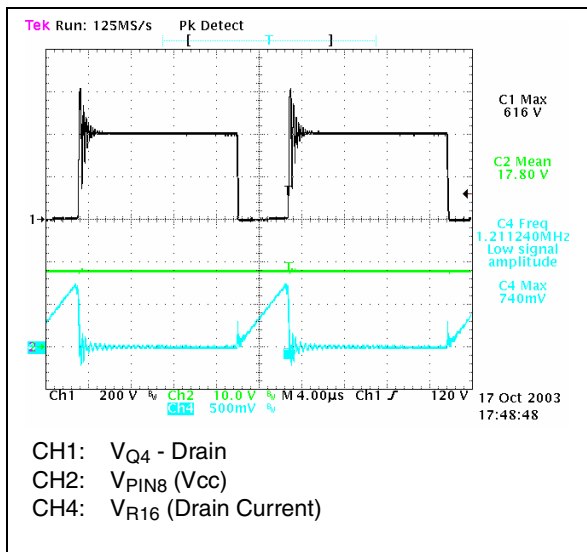

Figure 3. Drain voltage & current @230 V_{AC} - 50Hz - full load



The pictures here above show the drain voltage and current at the nominal input mains voltage during normal operation at full load. As visible, the circuit works in CCM both at nominal high and low mains.

The figure 4 shows the measurement of the drain peak voltage at full load and maximum input mains voltage. The measured voltage of 672V, ensures a reliable operation of the MOSFET with a good margin against the maximum BV_{DSS}. Even the maximum rectifiers PIV have been measured dur-

ing the worst operating condition and they are indicated on the right of figure 5. The margin, with respect to the maximum voltage withstood by each diode, ensures safe operating conditions for these devices.

Figure 4. Drain voltage & current @265 V_{AC} - 50Hz - full load

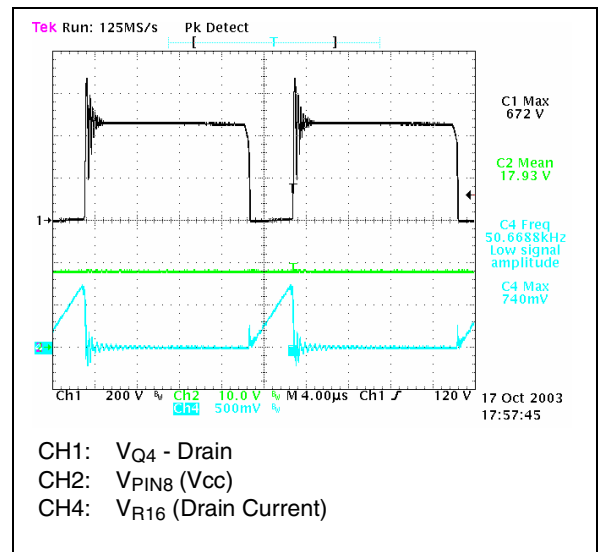
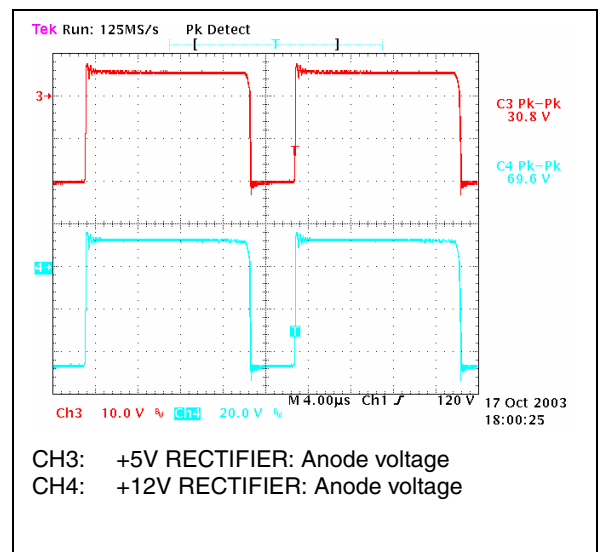

Figure 5. Maximum rectifiers PIV @Vin = 265 V_{AC} - 50 Hz and full load



Here following the most salient controller IC signals are shown. In both pictures it is possible to distinguish clean waveforms free of hard spikes or noise that could affect the controller correct operation.

Figure 6. Drain voltage & current @115 V_{AC} - 60Hz - full load

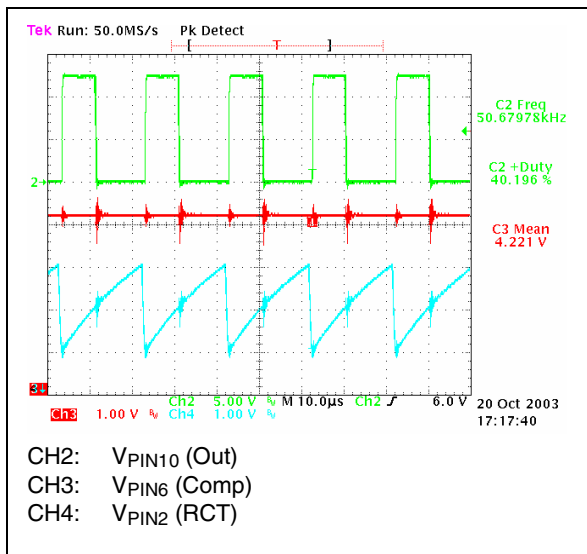
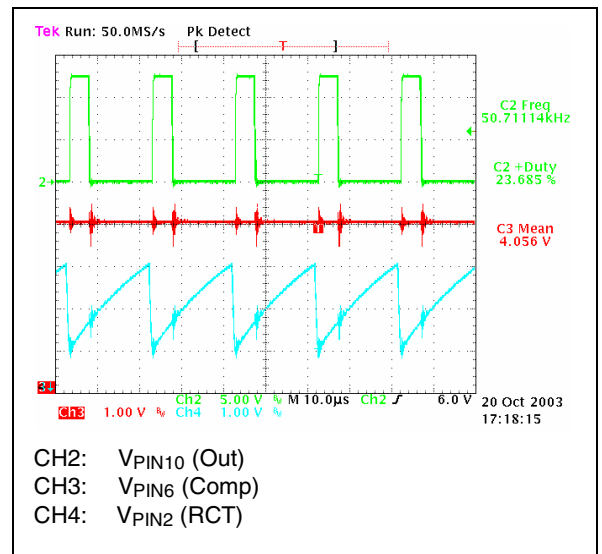

Figure 7. Drain voltage & current @230 V_{AC} - 50Hz - full load



Cross regulation

In the following tables it has been reported the output voltage cross regulation measurements with static loads. The overall efficiency of the converter is also calculated at the nominal input voltages.

To check the application circuit it has been tested keeping constant the current on the 5V and varying the 12V load. As visible in both tables, the voltages are within their tolerance at any load condition and the circuit efficiency is good

5V ± 2%		12V ± 10%		TOLERANCE	P _{outTOT} [W]	115 Vac		V _{aux} [V]	f _s [KHz]
V _{out} [V]	@I _{out} [A]	V _{out} [V]	@I _{out} [A]			Pin [W]	Efficiency		
5.106	2	12.11	4	OK	58.65	71.7	81.8%	18.3	51
5.107	2	12.23	3	OK	46.90	56.6	82.9%	17.4	51
5.108	2	12.40	2	OK	35.02	42.1	83.2%	16.7	51
5.110	2	12.72	1	OK	22.94	27.7	82.8%	16.5	51
5.110	2	13.11	0.5	OK	16.78	20.7	81.0%	16.6	51
5.108	1	11.85	4	OK	52.51	63.9	82.2%	17.5	51
5.108	1	12.00	3	OK	41.11	49.4	83.2%	16.7	51
5.110	1	12.15	2	OK	29.41	35.0	84.0%	16.2	51
5.112	1	12.39	1	OK	17.50	21.0	83.3%	15.9	51
5.112	1	12.66	0.5	OK	11.44	14.0	81.7%	15.9	51

5V ± 2%		12V ± 10%		TOLERANCE	Pout _{TOT} [W]	230 Vac		Vaux [V]	fs [KHz]
Vout [V]	@Iout [A]	Vout [V]	@Iout [A]			Pin [W]	Efficiency		
5.106	2	12.09	4	OK	58.57	69.3	84.5%	17.7	51
5.107	2	12.23	3	OK	46.90	55.3	84.8%	17.3	51
5.109	2	12.40	2	OK	35.02	41.2	85.0%	16.9	51
5.110	2	12.74	1	OK	22.96	27.6	83.2%	16.6	51
5.110	2	13.12	0.5	OK	16.78	20.8	80.7%	16.6	51
5.108	1	11.85	4	OK	52.51	63.9	82.2%	17.5	51
5.108	1	12.00	3	OK	41.11	49.4	83.2%	16.7	51
5.110	1	12.15	2	OK	29.41	35.0	84.0%	16.2	51
5.112	1	12.39	1	OK	17.50	21.0	83.3%	15.9	51
5.112	1	12.66	0.5	OK	11.44	14.0	81.7%	15.9	51

Standby operation

Like in the previous section, the output voltages and the efficiency have been checked, and the input power has been measured. It is clearly visible that with the required standby load (5V@30mA, 12V@0mA) **the input power consumption is well below 800mW** at both the input voltage ranges. Besides, the circuit has been characterised at both the nominal input voltage values for different output load and the efficiency is high in all conditions. In the fig. 8, it is shown the output voltage variation as a function of the 5V current.

During the standby operation the circuit works at reduced frequency, according to load and input voltage therefore, thanks to this function, the switching losses are minimized. This allows reaching very low standby consumption because in a power switch the switching and the capacitive losses are directly proportional to the working frequency.

5V		Pout _{TOT} [W]	115 Vac	
Vout [V]	@Iout [mA]		Pin [W]	Efficiency
5.11	20	0.102	0.433	23.6%
5.11	30	0.153	0.515	29.8%
5.11	40	0.204	0.593	34.5%
5.11	50	0.256	0.667	38.3%
5.11	60	0.307	0.745	41.1%
5.11	80	0.409	0.881	46.4%
5.11	100	0.511	1.021	50.1%

5V		Pout _{TOT} [W]	230Vac	
Vout [V]	@Iout [mA]		Pin [W]	Efficiency
5.11	20	0.102	0.493	20.7%
5.11	30	0.153	0.582	26.3%
5.11	40	0.204	0.672	30.4%
5.11	50	0.256	0.755	33.8%
5.11	60	0.307	0.842	36.4%
5.11	80	0.409	1.008	40.6%
5.11	100	0.511	1.168	43.8%

Figure 8. INPUT POWER @LOW LOAD

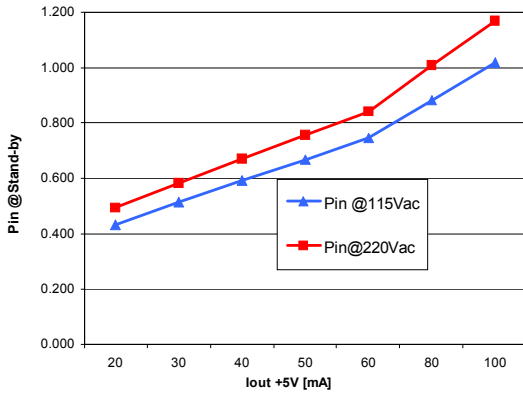

Here following, in figures 9 and 10 some waveforms during standby are shown:

Figure 9. Standby @115 V_{AC} - 60Hz 5V @50mA load

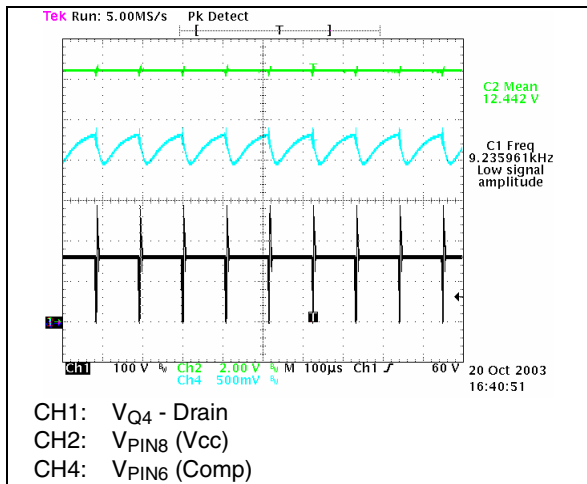
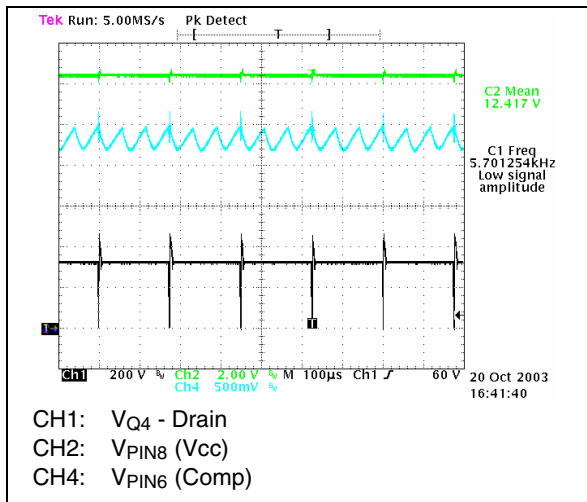
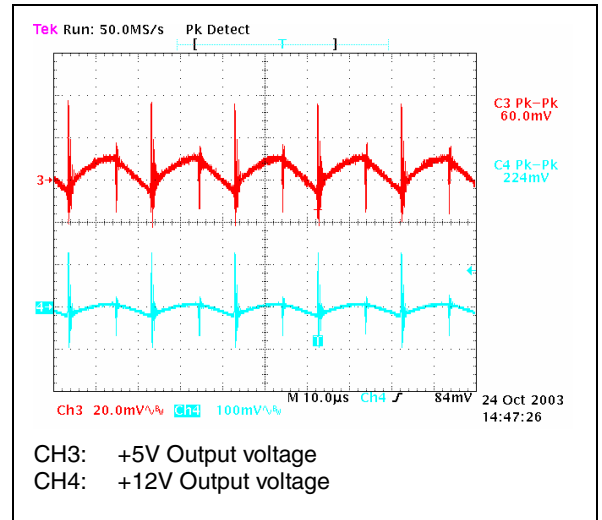

Figure 10. Standby @230 V_{AC} - 50Hz 5V @ 50mA load



Output voltage ripple @full load

Figure 11. Output voltage ripple @Vin = 115 Vac - 60 Hz and full load



In figure 11 the output voltage ripples at switching frequency are measured. As shown, the ripple and the spikes are very low thanks to the additional LC filters added on both output and avoiding the use of bigger or expensive output capacitors.

The residual line frequency modulation is very low at any input voltage.

Dynamic Load Tests

Figure 12 shows the output voltage regulation for a dynamic load variation of the 5V output. As shown in the picture the voltage variation and the response time are very good showing a good loop behaviour. In fact, the 5V voltage variation is less than 20mV (0,4%), and the spikes during the load transition, due to the filter inductor on the output, are only 75mV beyond the steady state (1,5%). The measured recovery time is few tens of microseconds. The variations induced on the 12V output have been also checked without showing any abnormal variation. Besides, the circuit response has been verified at minimum, nominal and maximum input voltage, showing no significant change.

**Figure 12. +5V Dynamic load 1.5 ÷ 2A, 70Hz
+12V: FULL LOAD - @115 V_{AC} - 60Hz**

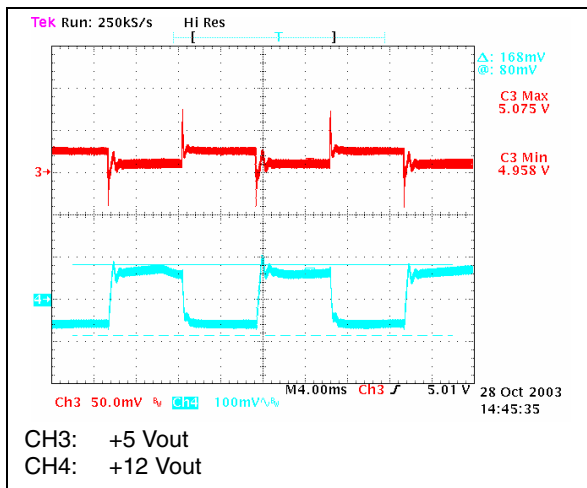

In Figure 13 it is reported the response of the output voltages for a load variation of the 12V output as detailed on top of the picture. The measurement has been done varying the 12V load from 50% to 100% load: the voltage variation is around 340mV and the 5V output is almost unaffected. Therefore, the conclusion is that there is no abnormal behaviour of the SMPS generated by a load change, allowing a good confidence for the integration of the SMPS in the equipment.

**Figure 13. +12V Dynamic load 2 ÷ 4A, 70Hz
+5V: FULL LOAD - @115 V_{AC} - 60Hz**

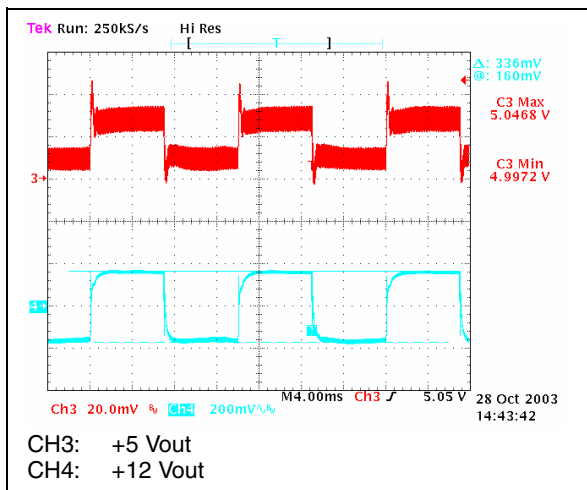

Start-Up Behaviour @full load and Wake-up time

In figure14 the wake-up time is measured at the lower nominal input mains and the controller start-up sequence is shown. The V_{cc} capacitor is charged by the charge pump circuit and when its voltage reaches the start-up threshold the device

starts to operate and the output voltages begin to rise up to the nominal value, where the control loop provides for the regulation. The wake-up time at 115Vac is 1.2 s, which is a quite typical time for this kind of Power Supplies. Besides, on the picture it is clearly visible that no any overshoot, undershoot, dip or lost of control happens during the power supply start-up phase.

Figure 14. Wake-up time @115 V_{AC} - 60Hz

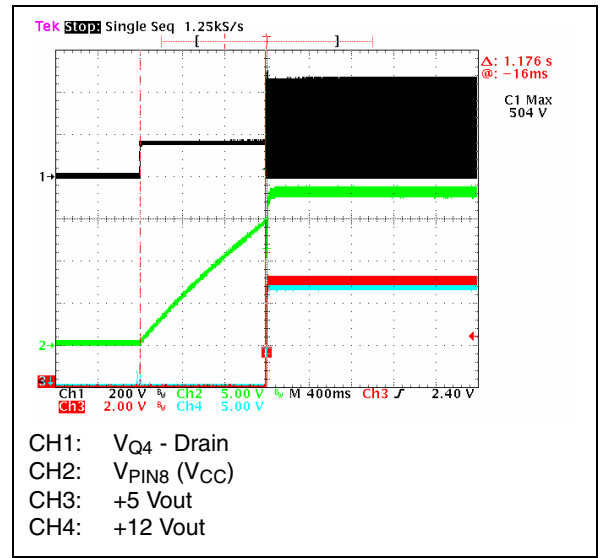

**Figure 15. Start-Up Behaviours @full load -
@90 V_{AC} - 60Hz**

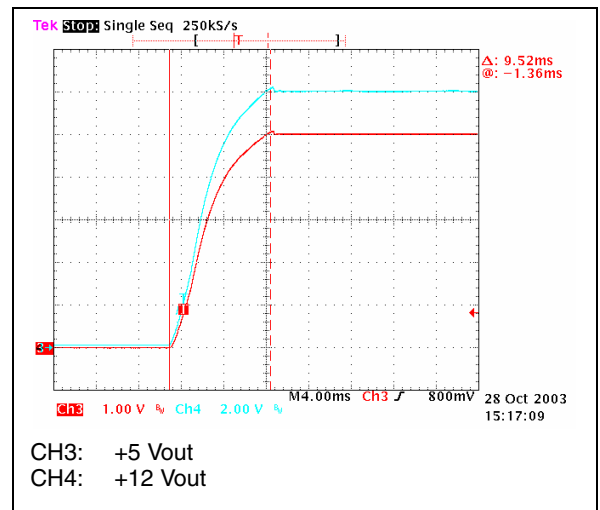

In the above picture the rising slopes at full load of the output voltages at minimum input mains voltage are captured and the rise time is measured. As shown in the pictures, the rising time is monotonic and it is almost constant overall the input mains range. No any overshoot or abnormal behaviour is present overall the input main range.

Turn-Off and Hold-up time

In figure 16 the most salient waveforms at turn-off are shown. Even at turn off the transition is clean, without abnormal behaviour like restarting attempts or loss of control by the loop. The Hold-up time, in evidence between the vertical lines, is 13.6 ms at 115Vac-50Hz, full load and becomes around 67ms at 230Vac.

Figure 16. Hold-up @115 V_{AC} -50Hz - full load

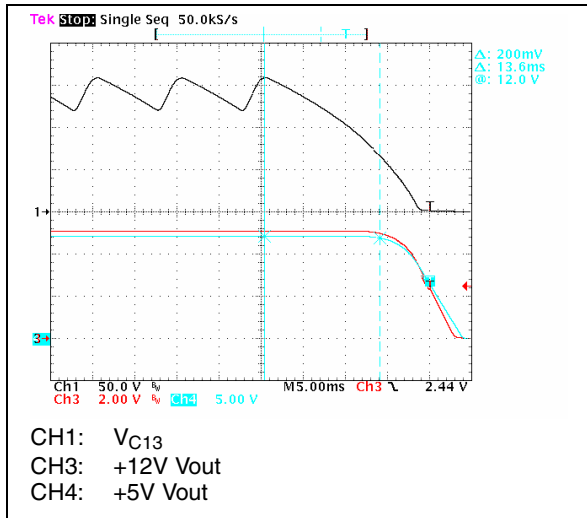

Short-Circuit Tests at Full Load

The short circuit tests have been done under several conditions, all over the input mains range. To avoid any catastrophic failure of the circuit due to overstress, a deep check of component stress has been done. The main circuit parameters that have been checked are the Mosfet drain voltage and the mean value of the output current. The drain voltage is an important parameter to be monitored during short circuits because an excessive increase due to the transformer leakage inductance and the overcurrent flowing in the primary can cause the MOSFET BV_{DSS} to be exceeded. In the proposed circuit, thanks to the low leakage inductance of the transformer and to the start-up component correct dimensioning, in case any output is shorted, the MOSFET drain voltage is below its BV_{DSS} and the mean value of the output current is low too, thus preventing component overheating because of the excessive power dissipation. In this case the reliability against long term-shorts is not affected even at 264Vrms. The auto-restart at short removal has been also checked and it is correct in all conditions.

Figure 17. Short circuit on 5V @90 V_{AC} - 60Hz - full load

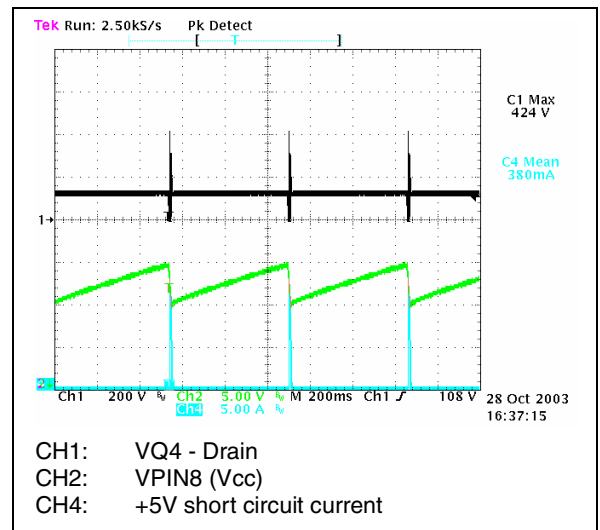
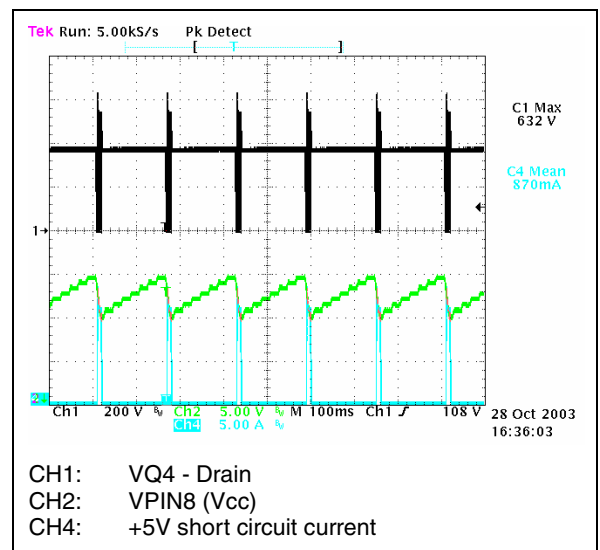

Figure 18. Short circuit on 5V @265 V_{AC} - 50Hz - full load



As clearly indicated by the waveforms in figure 17 and 18, the circuit works in hiccup mode, keeping the mean value of the current at levels compatible with the component rating. As visible the circuit working time is constant because it depends only on the auxiliary capacitor value, while the dead time is inversely proportional to the input mains voltage. In the following figures 19 and 20 the waveforms relevant to the 12V output in short circuit at both the nominal input mains voltage are reported: as visible, the circuit protects itself and the load.

Figure 19. Short circuit on 12V @90 V_{AC} - 60Hz - full load

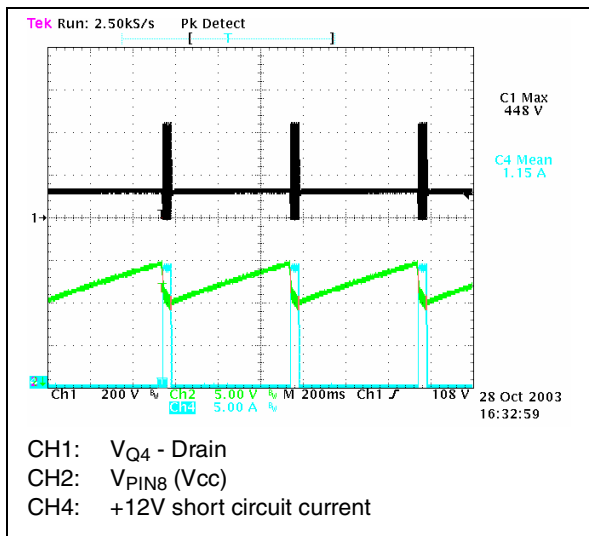
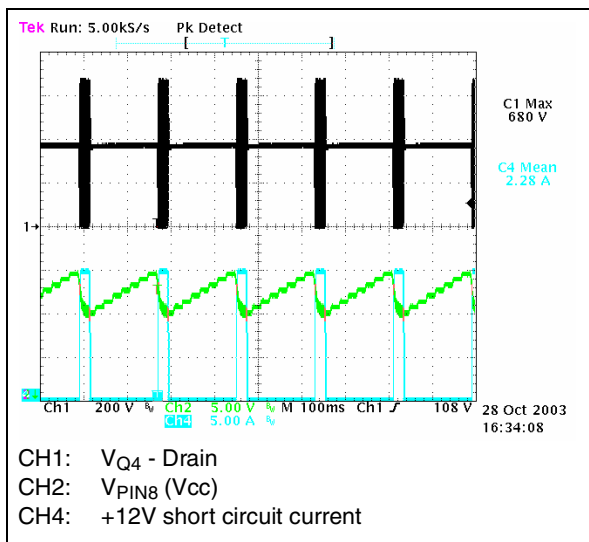

Figure 20. Short circuit on 12V @265 V_{AC} - 50Hz - full load



Short Circuit Protection @ Low Load

After the full load tests, some checks on the short circuit protection with reduced loads have been done, as reported here following. The tests have been done even at minimum and maximum input voltage with the same results, as the previous tests.

@Half Load

The waveforms of figure 21 are relevant to a short circuit test simulating a fault during normal opera-

tions of the equipment, with a consumption halved with respect to the maximum output power levels ($I_{+12V} = 2A$, $I_{+5V} = 1A$).

- At Vin = 90Vac: shorting each output the over current protection works correctly, providing for the hiccup mode.
- At Vin = 265Vac: the circuit behaves correctly.

Figure 21. Short circuit on 5V @265 V_{AC} - 50Hz - half load

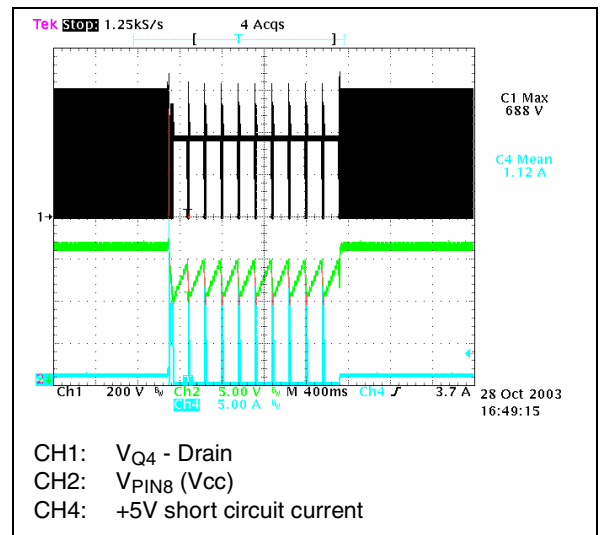

@Reduced Load

This condition simulates a fault during an operating transition of the equipment, with the backlight off and a reduced consumption of the other output ($I_{+12V} = 0A$, $I_{+5V} = 0.5A$).

- At Vin = 90Vac: shorting each output the over current protection works correctly, providing for the hiccup working mode.
- At Vin = 265Vac: the behaviour of the circuit is correct like at 90Vac.

@Standby

This condition simulates a fault during the standby operation of the equipment, with the backlight and the scaler off, and the μP working with a reduced consumption ($I_{+12V} = 0A$, $I_{+5V} = 33mA$).

- At Vin = 90Vac: shorting each output the over current protection works correctly, providing for the hiccup working mode.
- At Vin = 265Vac: the behaviour of the circuit is correct like at 115Vac.

Figure 22. Short circuit on 5V @265 V_{AC} - 50Hz - standby load

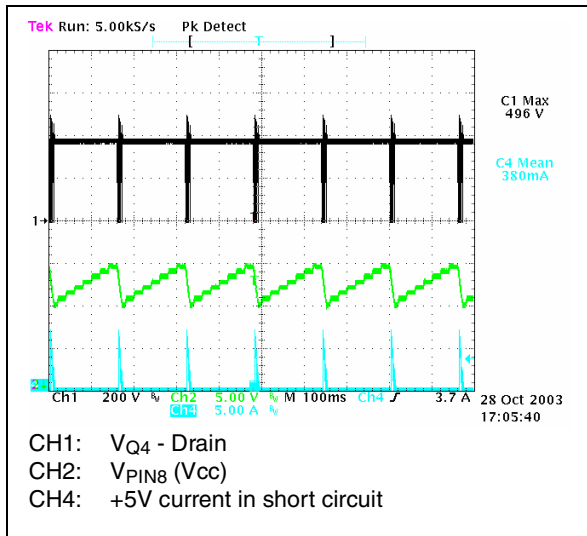
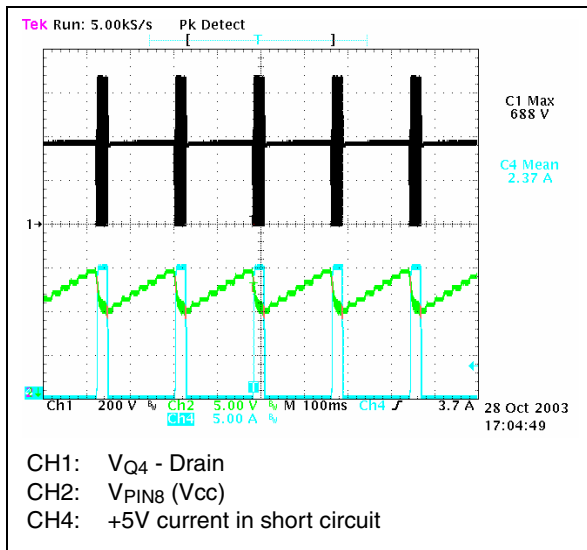

Figure 23. Short circuit on 12V @265 V_{AC} - 50Hz - standby load



The main circuit parameter measurements have been done also during the test at reduced load or standby. In detail, during standby short it is possible to check the perfect functionality of the protection. This load condition in fact, is critical because all the power available from the converter can be delivered to one output only, because the others are lightly loaded or unloaded, and this can bring to the destruction of the rectifier of the shorted output. Besides, during standby operation, the transformer coupling and the leakage inductance may be capable of supplying the controller charging the V_{DD} capacitor by the spikes generated at Mosfet

turn-off, preventing the hiccup mode. To avoid this, the circuit around Q2 and Q3 has been added, providing the hiccup mode anyway. As visible in the pictures, the SMPS is always protected even in this very critical load condition.

Over Voltage Protection

The open-loop operation is a very dangerous event that could happen in case of a feedback circuitry failure. In this case, the SMPS output voltages can increase up to dangerous values, depending on the load by each output and the transformer coupling between the windings. Thus, if the circuit is not properly protected, the rectifiers and the output capacitors can be overstressed and be destroyed or even worse, to catch light. To avoid this, the safety rules ask that the SMPS have a protection against the mentioned safety risks. In the proposed circuit, in case of a control loop failure, a L5991 internal comparator stops the controller operation when the voltage at pin 14 (DIS) reaches 2.5V and remains latched until the V_{CC} voltage decreases below the UVLO threshold. So, a very safe protection with the L5991 is realized just by means of few passive components.

The circuit has been tested opening the loop, the output voltages have been measured giving the following results overall the mains input voltage range:

230Vac – 50Hz @FULL LOAD		230Vac – 50Hz @STANDBY	
5V @ 2A	12V @ 4A	5V @ 0.03A	12V @0A
V _{5V} : 5.7V	V _{12V} : 13.5V	V _{5V} : 6.24V	V _{12V} : 15.8V

As shown in the table, in both conditions the measured voltages are not critical for the circuitry.

Conducted Noise Measurements (Pre-Compliance Test)

The following pictures are the peak conducted noise measurements at full load and nominal mains voltages. The limits shown on the diagrams are those specified by the EN55022 CLASS-B, which is the most widely used for Information Technology Equipment intended for domestic use, in the bandwidth 150KHz 30MHz. The filter configuration used is the 2-wires one, without the ground connection at mains plug, suitable for domestic equipment like LCD-TVs. As visible on the diagrams, there is a good margin between the peak measures with respect to the AVG limits (lower ones), and this assures that the QP and Average measures will be within their respective limits.

Figure 24. EN55022 Class-B Peak Measure @115 V_{AC} - 60Hz - FULL LOAD

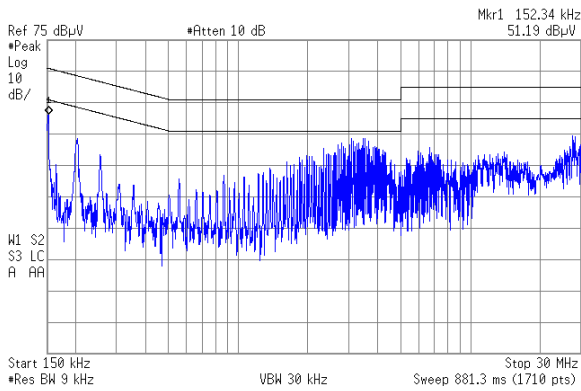
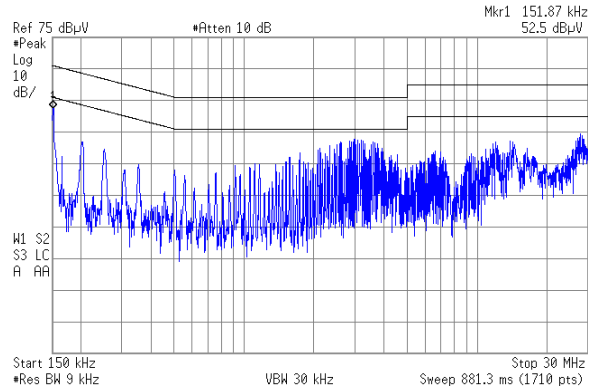

Figure 25. EN55022 Class-B Peak Measure 230 V_{AC} - 50Hz - FULL LOAD



Thermal measures

In order to check the reliability of the design a thermal mapping by means of an IR camera has been done. In the table here below the temperature of some salient components is reported at 115Vac and 230Vac input voltage, at ambient temperature (24°C).

Point	Reference	Description	@115Vac	@230Vac
			Temperature	Temperature
A	D9	BRIDGE RECTIFIER	74°C	54°C
B	L2	FILTER COIL	56°C	40°C
C	Q4	POWERMOS	70°C	58°C
D	T1	POWER TRANSF.	53°C	56°C
E	D16	+5V RECTIFIER	61°C	60°C
F	D13	+12V RECTIFIER	64°C	64°C

As visible in the above table there are not component working at a temperature level that can be considered critical for their reliability.

Board lay-out

Figure 26. Board silk-screen and bottom plane (not in scale)

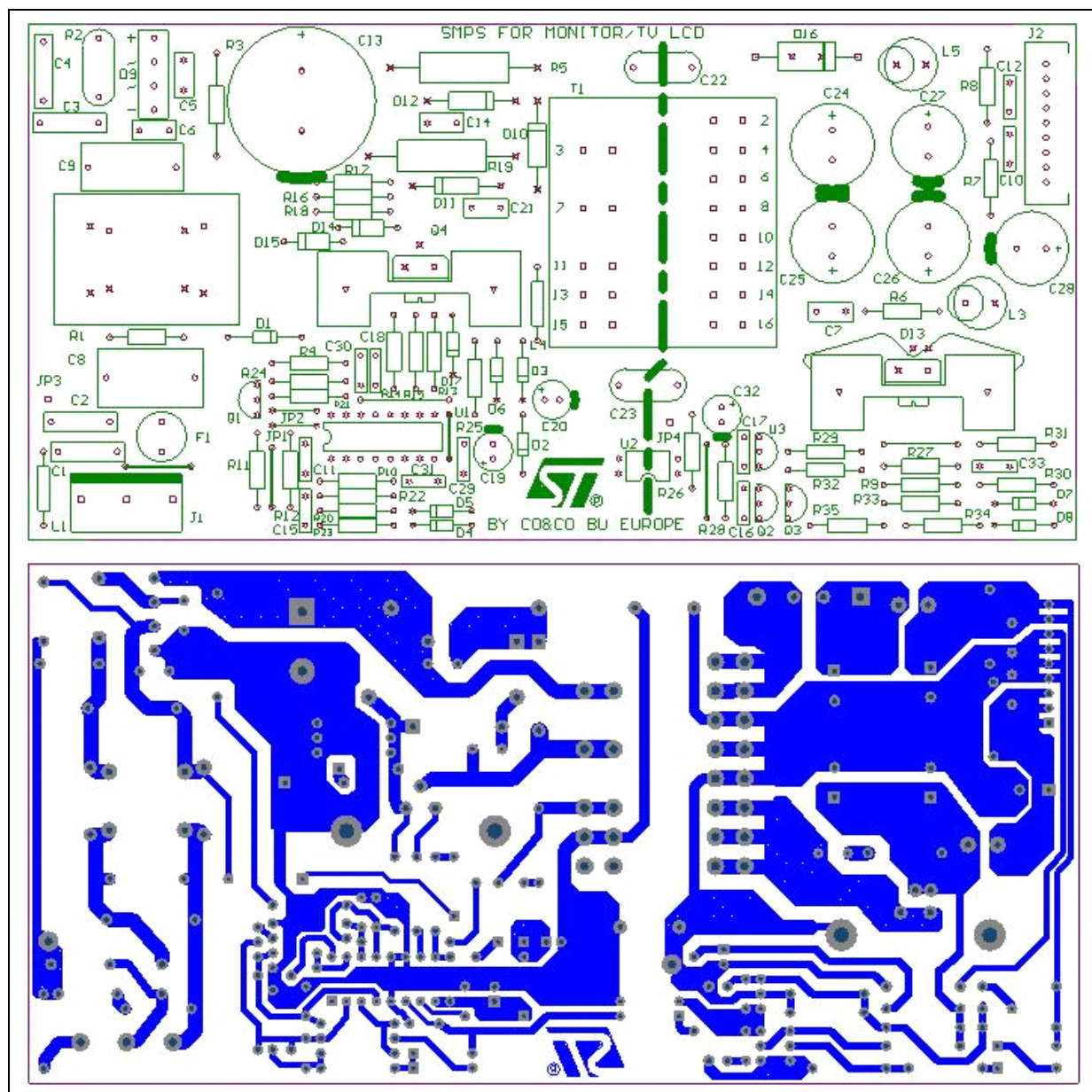

- Original size: 89x180mm
- Copper thickness: 70µm
- Material: CEM-1

Conclusions

An SMPS for LCD monitors or LCD-TV sets has been completely designed, assembled and tested using the L5991. All the different aspects (Component Electrical Stress, Functions, Protections, Conducted EMI, Thermal Stress) have been checked, giving positive results. The design meets also low-cost and low-complexity requirements, key factors in the Consumer Electronic market.

References

- [1] "L5991 Data Sheet"
- [2] "AN1537: A simple trick enhances L5991's standby function"

ANNEX1: Transformer spec

Transformer General Description

APPLICATION TYPE: Consumer, Home Appliance
 TRANSFORMER TYPE: Open, Varnished only
 WINDING TYPE: Slot
 COIL FORMER: Vertical type, 7+7 pins

MAX. TEMP. RISE: 45°C
 MAX. OPERATING AMB. TEMP. : 60°C
 MAINS INSULATION: ACC. WITH EN60065 - EN60950

Electrical Characteristics

CORE TYPE/GRADE: ETD34 - 3C90 or equivalent
 PRIMARY INDUCTANCE: 825 μH ±10% @1KHz - 0.25V
 LEAKAGE INDUCTANCE: 15 μH MAX @ 10KHz - 0.25V [1]
 PEAK PRIMARY CURRENT: 2 Apk

[1]: Measured between pins 3-7 with all secondary shorted

PROVIDED BY PULSE-ELDOR P/N: 2074.5056C

Figure 27. Electrical Diagram

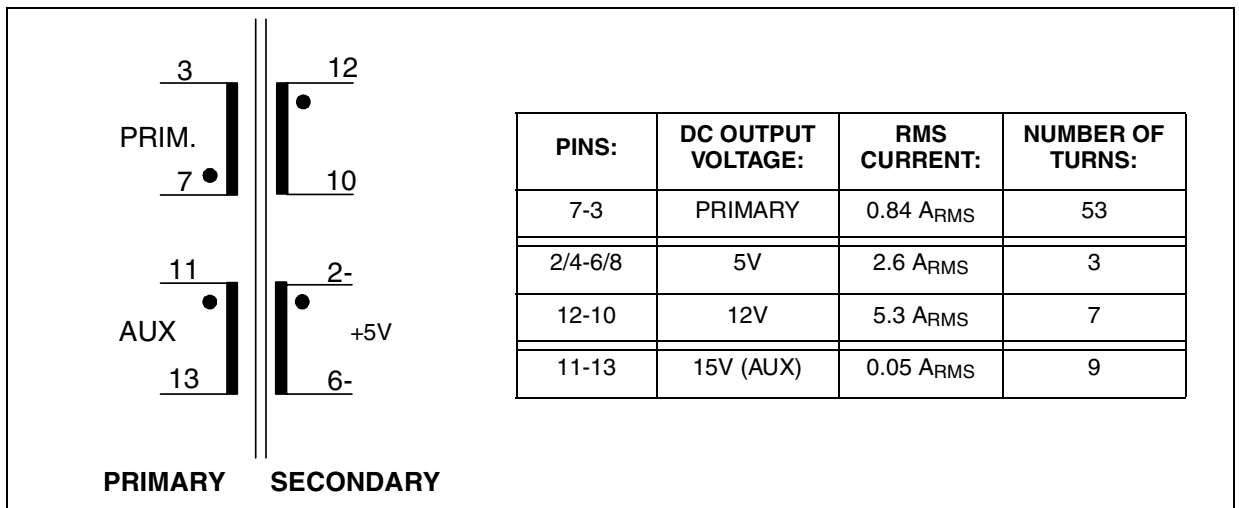

ANNEX2:

Part List

<i>Designator</i>	Part Type/ Part Value	Description	Supplier
C1	RES	NOT MOUNTED	
C10	220N - 50V	CERCAP	AVX
C101 (D17)	47N-400V	POLYESTER FILM CAP MKT	R66 - ARCOTRONICS
C102	220P - 50V	CERCAP	AVX
C11	100N - 50V	CERCAP	AVX
C12	220N - 50V	CERCAP	AVX
C13	100uF-400V	ALUMINIUM ELCAP	LP4 SERIES - ELNA
C14	2N2-1KV HR	HV CERCAP	DEHR33A222K - MURATA
C15	4N7 - 50V	CERCAP	AVX
C16	4N7 - 50V	CERCAP	AVX
C17	4N7 - 50V	CERCAP	AVX
C18	330P - 50V	CERCAP	AVX
C19	22uF-25V	ALUMINIUM ELCAP	RUBYCON
C2	RES	NOT MOUNTED	
C20	22uF-25V	ALUMINIUM ELCAP	RUBYCON
C21	220PF-2KV HR	HV CERCAP	DEHR33A221K - MURATA
C22	1N0 - Y1	Y1 SAFETY CAP.	DE1E3KX102M - MURATA
C23	1N0 - Y1	Y1 SAFETY CAP.	DE1E3KX102M - MURATA
C24	2200uF-16V YXF	ALUMINIUM ELCAP	RUBYCON
C25	1000uF-35V YXF	ALUMINIUM ELCAP	RUBYCON
C26	1000uF-35V YXF	ALUMINIUM ELCAP	RUBYCON
C27	470uF-10V YXF	ALUMINIUM ELCAP	RUBYCON
C28	100uF-50V YXF	ALUMINIUM ELCAP	RUBYCON
C29	22N - 50V	CERCAP	AVX
C3	RES	NOT MOUNTED	
C30	N68 - 50V	CERCAP	AVX
C31	3N3 - 50V	CERCAP	AVX
C32	47uF-25V YXF	ALUMINIUM ELCAP	RUBYCON
C33	10N - 50V	CERCAP	AVX
C4	RES	NOT MOUNTED	
C5	RES	NOT MOUNTED	
C6	RES	NOT MOUNTED	
C7	470PF - 50V	CERCAP	AVX
C8	220N-X2	X2 FILM CAPACITOR	R46-KI 3220 00 L2M - ARCOTRONICS
C9	220N-X2	X2 FILM CAPACITOR	R46-KI 3220 00 L2M - ARCOTRONICS
D10	STTH1L06	FAST REC. RECTIFIER	STMicroelectronics
D101	1N4148	GEN. PURPOSE DIODE	WISHAY
D102 (R13)	1N4148	GEN. PURPOSE DIODE	WISHAY
D11	STTH1L06	FAST REC. RECTIFIER	STMicroelectronics
D12	RES	NOT MOUNTED	
D13	STPS8H100CF	POWER SCHOTTKY RECT.	STMicroelectronics
D14	1N4007	RECTIFIER DIODE	WISHAY

AN1842 APPLICATION NOTE

Part List (continued)

<i>Designator</i>	Part Type/ Part Value	Description	Supplier
D15	1N4007	RECTIFIER DIODE	WISHAY
D16	STPS5L40	POWER SCHOTTKY RECT.	STMicroelectronics
D2	1N4148	GEN. PURPOSE DIODE	WISHAY
D3	BAV21	GEN. PURPOSE DIODE	WISHAY
D4	1N4148	GEN. PURPOSE DIODE	WISHAY
D5	1N4148	GEN. PURPOSE DIODE	WISHAY
D6	BAV21	GEN. PURPOSE DIODE	WISHAY
D7	1N4148	GEN. PURPOSE DIODE	WISHAY
D8	1N4148	GEN. PURPOSE DIODE	WISHAY
D9	2KBP06M	BRIDGE RECTIFIER	WISHAY
F1	FUSE T2A	FUSE 2 AMP. TIME DELAY	WICKMANN
J1		INPUT CONNECTOR, 2/3 POLES, 7.5MM	MOLEX
J2		OUTPUT CONNECTOR, 9 POLES, 2.54MM	MOLEX
JP1	JUMPER	WIRE JUMPER	
JP2	RES	NOT MOUNTED	
L1	RES	NOT MOUNTED	
L2	253Y1R2	25mH-1.2A - CM FILTER INDUCTOR	TDK
L3	2uH-4A	2uH-4A AXIAL FILTER INDUCTOR	B82111 SERIES - EPCOS
L4	10uH	RF AXIAL CHOKE	B78108-S1103-K - EPCOS
L5	2.7uH	DRUM COIL 2.7uH-4A	ELC08D SERIES - PANASONIC
Q1	BC547A	SMALL SIGNAL NPN BJT	STMicroelectronics
Q2	BC547A	SMALL SIGNAL NPN BJT	STMicroelectronics
Q3	BC547A	SMALL SIGNAL NPN BJT	STMicroelectronics
Q4	STP5NK80ZFP	POWER MOSFET	STMicroelectronics
R1	RES	NOT MOUNTED	
R10	4K7 - 1/4W - 5%	STANDARD FILM RESISTOR	BEYSCHLAG
R101 (D1)	100R - 1/4W - 5%	STANDARD FILM RESISTOR	BEYSCHLAG
R11	10K - 1/4W - 5%	STANDARD FILM RESISTOR	BEYSCHLAG
R12	12K - 1/4W - 5%	STANDARD FILM RESISTOR	BEYSCHLAG
R14	1K0 - 1/4W - 5%	STANDARD FILM RESISTOR	BEYSCHLAG
R15	47R - 1/4W - 5%	STANDARD FILM RESISTOR	BEYSCHLAG
R16	1R2 - 1/4W - 5%	STANDARD FILM RESISTOR	BEYSCHLAG
R17	1R2 - 1/4W - 5%	STANDARD FILM RESISTOR	BEYSCHLAG
R18	1R2 - 1/4W - 5%	STANDARD FILM RESISTOR	BEYSCHLAG
R19	4K7 - 2W - 5%	POWER RESISTOR 2W	BEYSCHLAG
R2	NTC_10R S236	NTC THERMISTOR	EPCOS
R20	RES	NOT MOUNTED	
R21	8K2 - 1/4W - 5%	STANDARD FILM RESISTOR	BEYSCHLAG
R22	3K9 - 1/4W - 5%	STANDARD FILM RESISTOR	BEYSCHLAG
R23	6K2 - 1/4W - 1%	METAL FILM RESISTOR	BEYSCHLAG
R24	2K0 - 1/4W - 1%	METAL FILM RESISTOR	BEYSCHLAG
R25	12K - 1/4W - 1%	METAL FILM RESISTOR	BEYSCHLAG
R26	1K5 - 1/4W - 5%	STANDARD FILM RESISTOR	BEYSCHLAG

Part List (continued)

<i>Designator</i>	Part Type/ Part Value	Description	Supplier
R27	10R - 1/4W - 5%	STANDARD FILM RESISTOR	BEYSCHLAG
R28	82K - 1/4W - 5%	STANDARD FILM RESISTOR	BEYSCHLAG
R29	2K43 - 1/4W - 1%	METAL FILM RESISTOR	BEYSCHLAG
R3	470K - 1/4W - 5%	STANDARD FILM RESISTOR	BEYSCHLAG
R30	2K43 - 1/4W - 1%	METAL FILM RESISTOR	BEYSCHLAG
R31	1K0 - 1/4W - 5%	STANDARD FILM RESISTOR	BEYSCHLAG
R32	47K - 1/4W - 5%	STANDARD FILM RESISTOR	BEYSCHLAG
R33	12K - 1/4W - 5%	STANDARD FILM RESISTOR	BEYSCHLAG
R34	3K3 - 1/4W - 5%	STANDARD FILM RESISTOR	BEYSCHLAG
R35	10K - 1/4W - 5%	STANDARD FILM RESISTOR	BEYSCHLAG
R4	470K - 1/4W - 5%	STANDARD FILM RESISTOR	BEYSCHLAG
R5	150K - 2W - 5%	POWER RESISTOR 2W	BEYSCHLAG
R6	33R - 1/4W - 5%	STANDARD FILM RESISTOR	BEYSCHLAG
R7	RES	NOT MOUNTED	
R8	RES	NOT MOUNTED	
R9	RES	NOT MOUNTED	
T1	2074.5056C	POWER TRANSFORMER	PULSE-ELDOR
U1	L5991	PRIMARY CONTROLLER WITH STANDBY	STMicroelectronics
U2	SFH617A-2	OPTOCOUPLER	INFINEON
U3	TL431ACZ	SHUNT REGULATOR	STMicroelectronics
	HEAT SINK FOR Q4	Rth _{HS-AMB} = 15°C/W	P/N 6098B THERMALLOY WITH CLAMP
	HEAT SINK FOR D13	Rth _{HS-AMB} = 10°C/W	P/N 6099B THERMALLOY WITH CLAMP

Information furnished is believed to be accurate and reliable. However, STMicroelectronics assumes no responsibility for the consequences of use of such information nor for any infringement of patents or other rights of third parties which may result from its use. No license is granted by implication or otherwise under any patent or patent rights of STMicroelectronics. Specifications mentioned in this publication are subject to change without notice. This publication supersedes and replaces all information previously supplied. STMicroelectronics products are not authorized for use as critical components in life support devices or systems without express written approval of STMicroelectronics.

The ST logo is a registered trademark of STMicroelectronics.
All other names are the property of their respective owners

© 2004 STMicroelectronics - All rights reserved

STMicroelectronics GROUP OF COMPANIES

Australia - Belgium - Brazil - Canada - China - Czech Republic - Finland - France - Germany - Hong Kong - India - Israel - Italy - Japan - Malaysia - Malta - Morocco - Singapore - Spain - Sweden - Switzerland - United Kingdom - United States

www.st.com