



# 74AUP1G96

## TinyLogic® Low Power Universal Configurable Two-Input Logic Gate (Open Drain Output)

### Features

- 0.8 V to 3.6V  $V_{CC}$  Supply Operation
- 3.6 V Over-Voltage Tolerant I/Os at  $V_{CC}$  from 0.8 V to 3.6 V
- Extremely High Speed  $t_{PD}$ 
  - 3.2 ns: Typical at 3.3 V
- Power-Off High-Impedance Inputs and Outputs
- Low Static Power Consumption
  - $I_{CC}=0.9 \mu A$  Maximum
- Low Dynamic Power Consumption
  - $C_{PD}=3.0$  pF Typical at 3.3 V
- Ultra-Small MicroPak™ Packages

### Description

The 74AUP1G96 is a universal configurable, two-input logic gate with an open-drain output that provides a high-performance and low-power solution for battery-powered portable applications. This product is designed for a wide low voltage operating range (0.8 V to 3.6 V) and guarantees very low static and dynamic power consumption across the entire voltage range. All inputs are implemented with hysteresis to allow for slower transition input signals and better switching noise immunity.

The 74AUP1G96 provides for multiple functions as determined by various configurations of the three inputs. The potential logic functions provided are MUX, AND, OR, NAND, and, NOR inverter and buffer (see *Figure 2 to Figure 8*).

### Ordering Information

Part Number	Top Mark	Package	Packing Method
74AUP1G96L6X	AP	6-Lead, MicroPak™ 1.0 x 1.45mm, JEDEC MO-252	5000 Units on Tape & Reel
74AUP1G96FHX	AP	6-Lead, MicroPak2™, 1x1mm Body, .35mm Pitch	5000 Units on Tape & Reel

## Pin Configurations

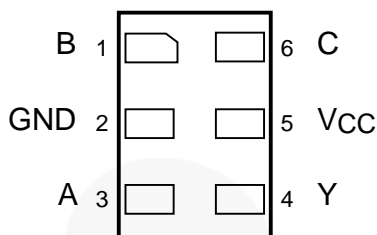

Figure 1. MicroPak™ (Top Through View)

## Pin Definitions

Pin #	Name	Description
1	B	Data Input
2	GND	Ground
3	A	Data Input
4	Y	Output (Open Drain)
5	V <sub>CC</sub>	Supply Voltage
6	C	Data Input

## Function Table

Inputs			Y=Output
C	B	A	
L	L	L	H <sup>(1)</sup>
L	L	H	H <sup>(1)</sup>
L	H	L	L
L	H	H	L
H	L	L	H <sup>(1)</sup>
H	L	H	L
H	H	L	H <sup>(1)</sup>
H	H	H	L

H = HIGH Logic Level

L = LOW Logic Level

**Note:**

1. High impedance output state, open drain.

2-Input Logic Function	Connection Configuration
2-to-1 MUX with Inverted Output	Figure 2
2-Input NAND Gate	Figure 3
2-Input NOR Gate with One Inverted Input	Figure 4
2-Input AND Gate with One Inverted Input	Figure 4
2-Input NAND Gate with One Inverted Input	Figure 5
2-Input OR Gate with One Inverted Input	Figure 5
2-Input NOR Gate	Figure 6
Buffer	Figure 7
Inverter	Figure 8

## Logic Configurations

Figure 2 through Figure 8 show the logical functions that can be implemented using the 74AUP1G98. The diagrams show the DeMorgan's equivalent logic duals for a given two-input function. The logical

implementation is next to the board-level physical implementation of how the pins of the function should be connected.

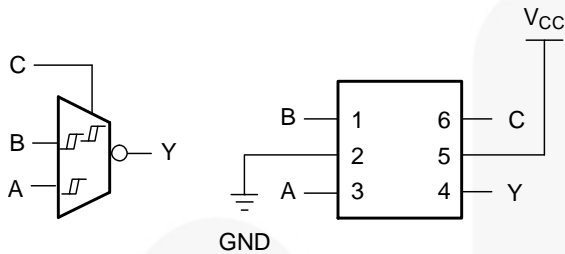

**Note:**

2. When C is L,  $Y = \overline{B}$ .
3. When C is H,  $Y = \overline{A}$ .

**Figure 2. 2-to-1 MUX with Inverted Output**

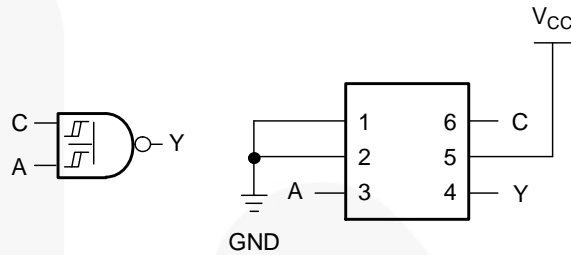

**Figure 3. 2-Input NAND Gate**

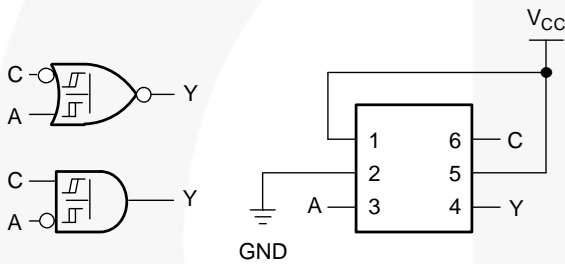

**Figure 4. Input NOR Gate with One Inverted Input  
2-Input AND Gate with One Inverted Input**

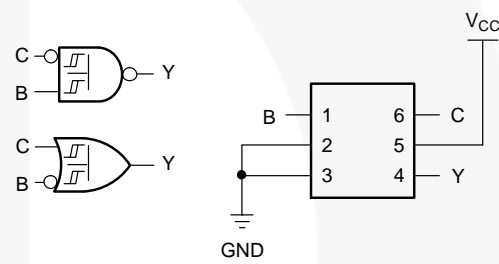

**Figure 5. 2-Input NAND Gate with One Inverted Input  
2-Input OR Gate with One Inverted Input**

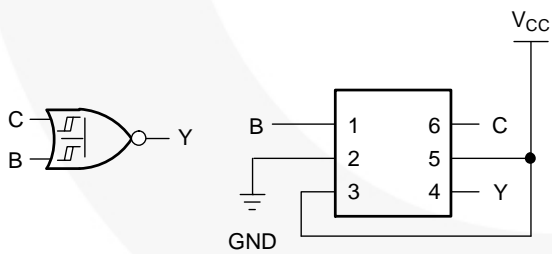

**Figure 6. 2-Input NOR Gate**

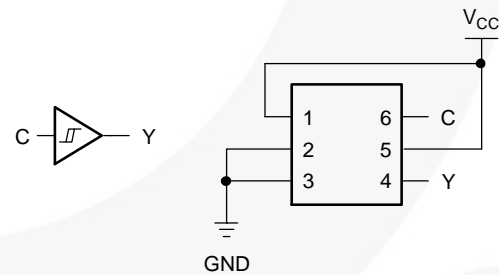

**Figure 7. Buffer**

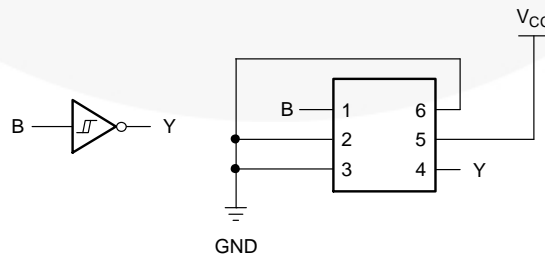

**Figure 8. Inverter**

## Absolute Maximum Ratings

Stresses exceeding the absolute maximum ratings may damage the device. The device may not function or be operable above the recommended operating conditions and stressing the parts to these levels is not recommended. In addition, extended exposure to stresses above the recommended operating conditions may affect device reliability. The absolute maximum ratings are stress ratings only.

Symbol	Parameter		Min.	Max.	Unit
V <sub>CC</sub>	Supply Voltage		-0.5	4.6	V
V <sub>IN</sub>	DC Input Voltage		-0.5	4.6	V
V <sub>OUT</sub> <sup>(2)</sup>	DC Output Voltage		-0.5	4.6	V
I <sub>IK</sub>	DC Input Diode Current	V <sub>IN</sub> < 0 V		-50	mA
I <sub>OK</sub>	DC Output Diode Current	V <sub>OUT</sub> < 0 V		-50	mA
I <sub>OL</sub>	DC Output Sink Current			+50	mA
I <sub>CC</sub> or I <sub>GND</sub>	DC V <sub>CC</sub> or Ground Current per Supply Pin			±50	mA
T <sub>STG</sub>	Storage Temperature Range		-65	+150	°C
T <sub>J</sub>	Junction Temperature Under Bias			+150	°C
T <sub>L</sub>	Junction Lead Temperature, Soldering 10s			+260	°C
P <sub>D</sub>	Power Dissipation at +85°C	MicroPak-6™		130	mW
		MicroPak2™-6		120	
ESD	Human Body Model, JEDEC:JESD22-A114			4000	V
	Charged Device Model, JEDEC:JESD22-C101			2000	

**Note:**

2. I<sub>O</sub> absolute maximum rating must be observed.

## Recommended Operating Conditions<sup>(3)</sup>

The Recommended Operating Conditions table defines the conditions for actual device operation. Recommended operating conditions are specified to ensure optimal performance to the datasheet specifications. Fairchild does not recommend exceeding them or designing to Absolute Maximum Ratings.

Symbol	Parameter	Condition	Min.	Max.	Unit
V <sub>CC</sub>	Supply Voltage		0.8	3.6	V
V <sub>IN</sub>	Input Voltage		0	3.6	V
V <sub>OUT</sub>	Output Voltage		0	3.6	V
I <sub>OL</sub>	Output Current	V <sub>CC</sub> =3.0 V to 3.6 V		±4.0	mA
		V <sub>CC</sub> =2.3 V to 2.7 V		±3.1	
		V <sub>CC</sub> =1.65 V to 1.95 V		±1.9	
		V <sub>CC</sub> =1.4 V to 1.6 V		±1.7	
		V <sub>CC</sub> =1.1 V to 1.3 V		±1.1	
		V <sub>CC</sub> =0.8 V		±20.0	µA
T <sub>A</sub>	Operating Temperature, Free Air		-40	+85	°C
θ <sub>JA</sub>	Thermal Resistance	MicroPak-6™		500	°C/W
		MicroPak2™-6		560	

**Note:**

3. Unused inputs must be held HIGH or LOW. They may not float.

## DC Electrical Characteristics

Symbol	Parameter	V <sub>CC</sub>	Condition	T <sub>A</sub> =25°C		T <sub>A</sub> =-40 to 85°C		Unit
				Min.	Max.	Min.	Max.	
V <sub>P</sub>	Positive Threshold Voltage	0.80		0.30	0.60	0.30	0.60	V
		1.10		0.53	0.90	0.53	0.90	
		1.40		0.74	1.11	0.74	1.11	
		1.65		0.91	1.29	0.91	1.29	
		2.30		1.37	1.77	1.37	1.77	
		3.00		1.88	2.29	1.88	2.29	
V <sub>N</sub>	Negative Threshold Voltage	0.80		0.10	0.60	0.10	0.60	V
		1.10		0.26	0.65	0.26	0.65	
		1.40		0.39	0.75	0.39	0.75	
		1.65		0.47	0.84	0.47	0.84	
		2.30		0.69	1.04	0.69	1.04	
		3.00		0.88	1.24	0.88	1.24	
V <sub>H</sub>	Hysteresis Voltage	0.80		0.07	0.50	0.07	0.50	V
		1.10		0.08	0.46	0.08	0.46	
		1.40		0.18	0.56	0.18	0.56	
		1.65		0.27	0.66	0.27	0.66	
		2.30		0.53	0.92	0.53	0.92	
		3.00		0.79	1.31	0.79	1.31	
V <sub>OL</sub>	LOW Level Output Voltage	0.80 ≤ V <sub>CC</sub> ≤ 3.60	I <sub>OL</sub> =20 μA		0.10		0.10	V
		1.10 ≤ V <sub>CC</sub> ≤ 1.30	I <sub>OL</sub> =1.1 mA		0.30 x V <sub>CC</sub>		0.30 x V <sub>CC</sub>	
		1.40 ≤ V <sub>CC</sub> ≤ 1.60	I <sub>OL</sub> =1.7 mA		0.31		0.37	
		1.65 ≤ V <sub>CC</sub> ≤ 1.95	I <sub>OL</sub> =1.9 mA		0.31		0.35	
		2.30 ≤ V <sub>CC</sub> ≤ 2.70	I <sub>OL</sub> =3.1 mA		0.44		0.45	
		2.70 ≤ V <sub>CC</sub> ≤ 3.60	I <sub>OL</sub> =4.0 mA		0.44		0.45	
I <sub>IN</sub>	Input Leakage Current	0 V to 3.6 V	0 ≤ V <sub>IN</sub> ≤ 3.6 V		±0.1		±0.5	μA
I <sub>OFF</sub>	Power Off Leakage Current	0 V	0 ≤ (V <sub>IN</sub> , V <sub>O</sub> ) ≤ 3.6 V		0.2		0.6	μA
ΔI <sub>OFF</sub>	Additional Power Off Leakage Current	0 V to 0.2 V	V <sub>IN</sub> or V <sub>O</sub> =0 V to 3.6 V		0.2		0.6	μA
I <sub>CC</sub>	Quiescent Supply Current	0.8 V to 3.6 V	V <sub>IN</sub> - V <sub>CC</sub> or GND		0.5		0.9	μA
			V <sub>CC</sub> ≤ V <sub>IN</sub> ≤ 3.6 V				±0.9	
ΔI <sub>CC</sub>	Increase in I <sub>CC</sub> per Input	3.3 V	V <sub>IN</sub> =V <sub>CC</sub> -0.6 V		40.0		50.0	μA

### AC Electrical Characteristics

Symbol	Parameter	V <sub>CC</sub>	Condition	T <sub>A</sub> =25°C			T <sub>A</sub> =-40 to 85°C		Unit
				Min.	Typ.	Max.	Min.	Max.	
t <sub>PZL</sub> , t <sub>PLZ</sub>	Propagation Delay	0.80	C <sub>L</sub> =15 pF, R <sub>U</sub> =R <sub>D</sub> =5 KΩ V <sub>I</sub> = 2 x (V <sub>CC</sub> ) (See Figure 9)		30				
		1.10 ≤ V <sub>CC</sub> ≤ 1.30		1.0	10.1	18.9	1.0	19.9	
		1.40 ≤ V <sub>CC</sub> ≤ 1.60		1.0	6.6	11.4	1.0	12.2	
		1.65 ≤ V <sub>CC</sub> ≤ 1.95		1.0	6.3	8.7	1.0	9.7	
		2.30 ≤ V <sub>CC</sub> ≤ 2.70		1.0	4.7	6.9	1.0	7.5	
		3.00 ≤ V <sub>CC</sub> ≤ 3.60		1.0	4.6	6.8	1.0	7.4	
C <sub>IN</sub>	Input Capacitance	0			0.8				pF
C <sub>OUT</sub>	Output Capacitance	0			1.7				pF
C <sub>PD</sub>	Power Dissipation Capacitance	0.80	V <sub>IN</sub> =0 V or V <sub>CC</sub> , f=10 MHz		3.0				pF
		1.10 ≤ V <sub>CC</sub> ≤ 1.30			3.1				
		1.40 ≤ V <sub>CC</sub> ≤ 1.60			3.2				
		1.65 ≤ V <sub>CC</sub> ≤ 1.95			3.4				
		2.30 ≤ V <sub>CC</sub> ≤ 2.70			3.8				
		3.00 ≤ V <sub>CC</sub> ≤ 3.60			4.4				

## AC Loadings and Waveforms

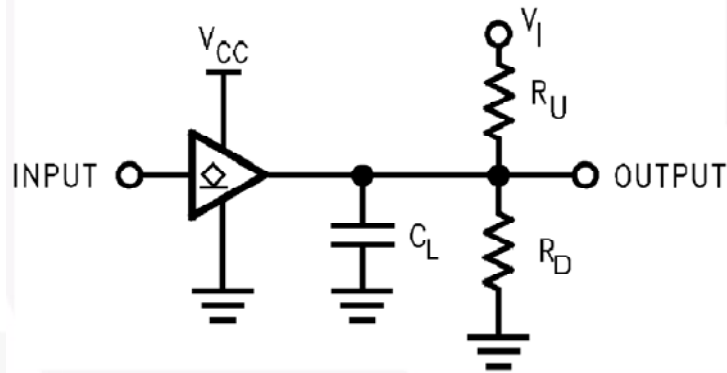

**Notes:**

- 4.  $C_L$  includes load and stray capacitance.
- 5. Input PRR = 1.0 MHz,  $t_w = 500$  ns.

**Figure 9. AC Test Circuit**

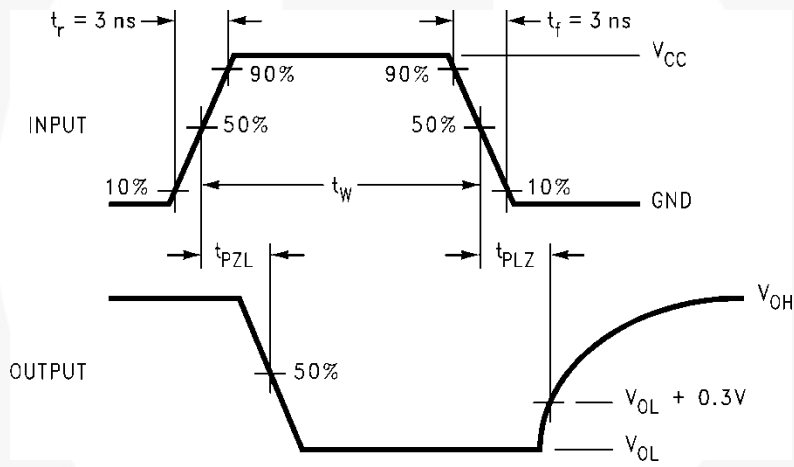

**Figure 10. AC Waveforms**

Symbol	$V_{CC}$					
	3.3 V ± 0.3 V	2.5 V ± 0.2 V	1.8 V ± 0.15 V	1.5 V ± 0.10 V	1.2 V ± 0.10 V	0.8 V
$V_{mi}$	$V_{CC}/2$	$V_{CC}/2$	$V_{CC}/2$	$V_{CC}/2$	$V_{CC}/2$	$V_{CC}/2$
$V_{mo}$	$V_{OL} + 0.3V$	$V_{OL} + 0.15V$	$V_{OL} + 0.15V$	$V_{OL} + 0.1V$	$V_{OL} + 0.1V$	$V_{OL} + 0.1V$

## Physical Dimensions

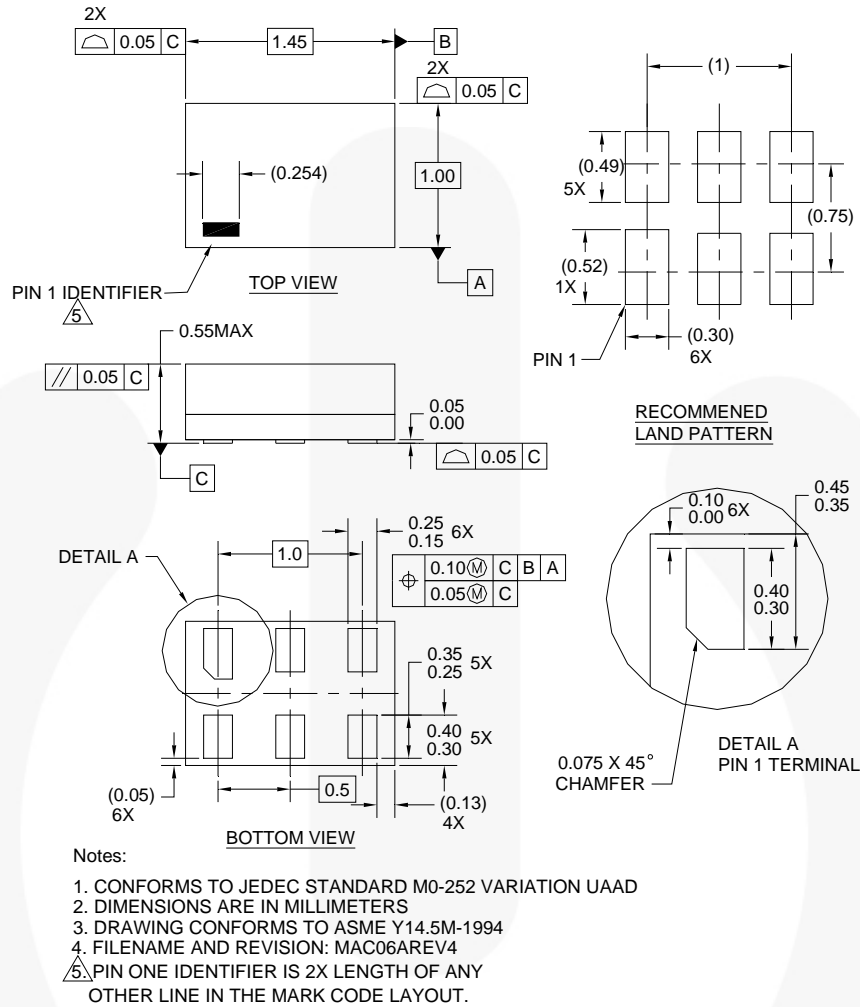

**Figure 11. 6-Lead, MicroPak™, 1.0 mm Wide**

Package drawings are provided as a service to customers considering Fairchild components. Drawings may change in any manner without notice. Please note the revision and/or date on the drawing and contact a Fairchild Semiconductor representative to verify or obtain the most recent revision. Package specifications do not expand the terms of Fairchild's worldwide terms and conditions, specifically the warranty therein, which covers Fairchild products.

Always visit Fairchild Semiconductor's online packaging area for the most recent package drawings:  
<http://www.fairchildsemi.com/packaging/>.

## Tape and Reel Specifications

Please visit Fairchild Semiconductor's online packaging area for the most recent tape and reel specifications:  
[http://www.fairchildsemi.com/products/logic/pdf/micropak\\_tr.pdf](http://www.fairchildsemi.com/products/logic/pdf/micropak_tr.pdf).

Package Designator	Tape Section	Cavity Number	Cavity Status	Cover Type Status
L6X	Leader (Start End)	125 (Typical)	Empty	Sealed
	Carrier	5000	Filled	Sealed
	Trailer (Hub End)	75 (Typical)	Empty	Sealed



## Physical Dimensions

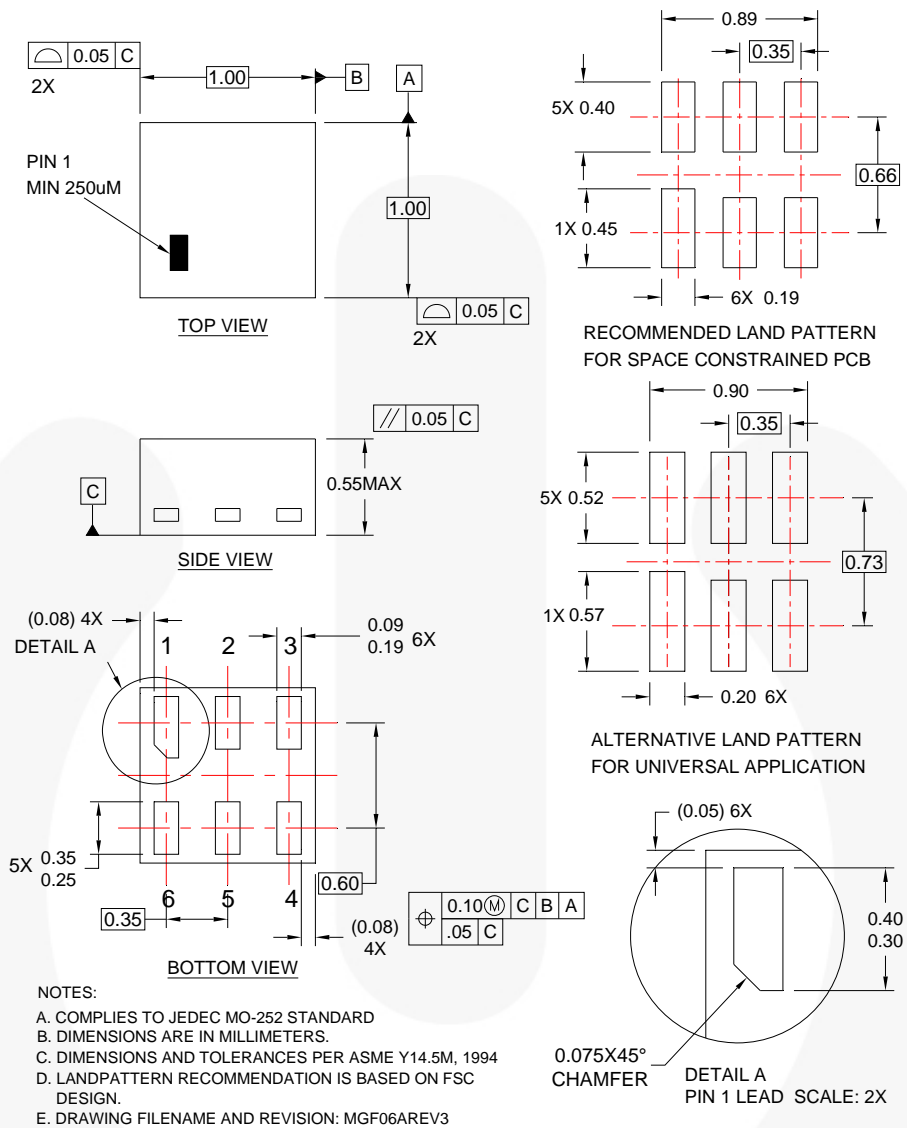

**Figure 12. 6-Lead, MicroPak2™, 1x1 mm Body, .35 mm Pitch**

Package drawings are provided as a service to customers considering Fairchild components. Drawings may change in any manner without notice. Please note the revision and/or date on the drawing and contact a Fairchild Semiconductor representative to verify or obtain the most recent revision. Package specifications do not expand the terms of Fairchild's worldwide terms and conditions, specifically the warranty therein, which covers Fairchild products.

Always visit Fairchild Semiconductor's online packaging area for the most recent package drawings:  
<http://www.fairchildsemi.com/packaging/>.

## Tape and Reel Specifications

Please visit Fairchild Semiconductor's online packaging area for the most recent tape and reel specifications:  
[http://www.fairchildsemi.com/packaging/MicroPAK2\\_6L\\_tr.pdf](http://www.fairchildsemi.com/packaging/MicroPAK2_6L_tr.pdf).

Package Designator	Tape Section	Cavity Number	Cavity Status	Cover Type Status
FHX	Leader (Start End)	125 (Typical)	Empty	Sealed
	Carrier	5000	Filled	Sealed
	Trailer (Hub End)	75 (Typical)	Empty	Sealed

**TRADEMARKS**

The following includes registered and unregistered trademarks and service marks, owned by Fairchild Semiconductor and/or its global subsidiaries, and is not intended to be an exhaustive list of all such trademarks.

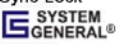
2Cool™	F-PFS™	PowerTrench®	The Power Franchise®
AccuPower™	FRFET®	PowerXS™	<b>the power franchise</b>
AX-CAP™*	Global Power Resource™	Programmable Active Droop™	TinyBoost™
BitSIC™	GreenBridge™	QFET®	TinyBuck™
Build it Now™	Green FPS™	QS™	TinyCalc™
CorePLUS™	Green FPS™ e-Series™	Quiet Series™	TinyLogic®
CorePOWER™	Gmax™	RapidConfigure™	TINYOPTO™
CROSSVOLT™	GTO™	 ™	TinyPower™
CTL™	IntelliMAX™	Saving our world, 1mW/W/kW at a time™	TinyPWM™
Current Transfer Logic™	ISOPLANAR™	SignalWise™	TinyWire™
DEUXPEED®	Making Small Speakers Sound Louder and Better™	SmartMax™	TranSIC™
Dual Cool™	MegaBuck™	SMART START™	TriFault Detect™
EcoSPARK®	MICROCOUPLER™	Solutions for Your Success™	TRUECURRENT®*
EfficientMax™	MicroFET™	SPM®	µSerDes™
ESBC™	MicroPak™	STEALTH™	
 Fairchild®	MicroPak2™	SuperFET®	UHC®
Fairchild Semiconductor®	MillerDrive™	SuperSOT™-3	Ultra FRFET™
FACT Quiet Series™	MotionMax™	SuperSOT™-6	UniFET™
FACT®	mWSaver™	SuperSOT™-8	VCX™
FAST®	OptoHi™	SupreMOS®	VisualMax™
FastvCore™	OPTOLOGIC®	SyncFET™	VoltagePlus™
FETBench™	OPTOPLANAR®	Sync-Lock™	XS™
FlashWriter®*		 SYSTEM GENERAL®*	
FPS™			

\* Trademarks of System General Corporation, used under license by Fairchild Semiconductor.

**DISCLAIMER**

FAIRCHILD SEMICONDUCTOR RESERVES THE RIGHT TO MAKE CHANGES WITHOUT FURTHER NOTICE TO ANY PRODUCTS HEREIN TO IMPROVE RELIABILITY, FUNCTION, OR DESIGN. FAIRCHILD DOES NOT ASSUME ANY LIABILITY ARISING OUT OF THE APPLICATION OR USE OF ANY PRODUCT OR CIRCUIT DESCRIBED HEREIN; NEITHER DOES IT CONVEY ANY LICENSE UNDER ITS PATENT RIGHTS, NOR THE RIGHTS OF OTHERS. THESE SPECIFICATIONS DO NOT EXPAND THE TERMS OF FAIRCHILD'S WORLDWIDE TERMS AND CONDITIONS, SPECIFICALLY THE WARRANTY THEREIN, WHICH COVERS THESE PRODUCTS.

**LIFE SUPPORT POLICY**

FAIRCHILD'S PRODUCTS ARE NOT AUTHORIZED FOR USE AS CRITICAL COMPONENTS IN LIFE SUPPORT DEVICES OR SYSTEMS WITHOUT THE EXPRESS WRITTEN APPROVAL OF FAIRCHILD SEMICONDUCTOR CORPORATION.

As used herein:

1. Life support devices or systems are devices or systems which, (a) are intended for surgical implant into the body or (b) support or sustain life, and (c) whose failure to perform when properly used in accordance with instructions for use provided in the labeling, can be reasonably expected to result in a significant injury of the user.
2. A critical component in any component of a life support, device, or system whose failure to perform can be reasonably expected to cause the failure of the life support device or system, or to affect its safety or effectiveness.

**ANTI-COUNTERFEITING POLICY**

Fairchild Semiconductor Corporation's Anti-Counterfeiting Policy. Fairchild's Anti-Counterfeiting Policy is also stated on our external website, [www.fairchildsemi.com](http://www.fairchildsemi.com), under Sales Support.

Counterfeiting of semiconductor parts is a growing problem in the industry. All manufacturers of semiconductor products are experiencing counterfeiting of their parts. Customers who inadvertently purchase counterfeit parts experience many problems such as loss of brand reputation, substandard performance, failed applications, and increased cost of production and manufacturing delays. Fairchild is taking strong measures to protect ourselves and our customers from the proliferation of counterfeit parts. Fairchild strongly encourages customers to purchase Fairchild parts either directly from Fairchild or from Authorized Fairchild Distributors who are listed by country on our web page cited above. Products customers buy either from Fairchild directly or from Authorized Fairchild Distributors are genuine parts, have full traceability, meet Fairchild's quality standards for handling and storage and provide access to Fairchild's full range of up-to-date technical and product information. Fairchild and our Authorized Distributors will stand behind all warranties and will appropriately address any warranty issues that may arise. Fairchild will not provide any warranty coverage or other assistance for parts bought from Unauthorized Sources. Fairchild is committed to combat this global problem and encourage our customers to do their part in stopping this practice by buying direct or from authorized distributors.

**PRODUCT STATUS DEFINITIONS**
**Definition of Terms**

Datasheet Identification	Product Status	Definition
Advance Information	Formative / In Design	Datasheet contains the design specifications for product development. Specifications may change in any manner without notice.
Preliminary	First Production	Datasheet contains preliminary data; supplementary data will be published at a later date. Fairchild Semiconductor reserves the right to make changes at any time without notice to improve design.
No Identification Needed	Full Production	Datasheet contains final specifications. Fairchild Semiconductor reserves the right to make changes at any time without notice to improve the design.
Obsolete	Not In Production	Datasheet contains specifications on a product that is discontinued by Fairchild Semiconductor. The datasheet is for reference information only.

Rev. I62