



### Typical Applications

The HMC554LC3B is ideal for:

- Point-to-Point Radios
- Point-to-Mult-Point Radios & VSAT
- Test Equipment & Sensors
- Military End-Use

### Features

- High LO/RF Isolation: 46 dB
- Passive Double Balanced Topology
- Low Conversion Loss: 7 dB
- Wide IF Bandwidth: DC - 6 GHz
- Robust 1,000V ESD, Class 1C
- 12 Lead Ceramic 3x3mm SMT Package: 9mm<sup>2</sup>

### Functional Diagram

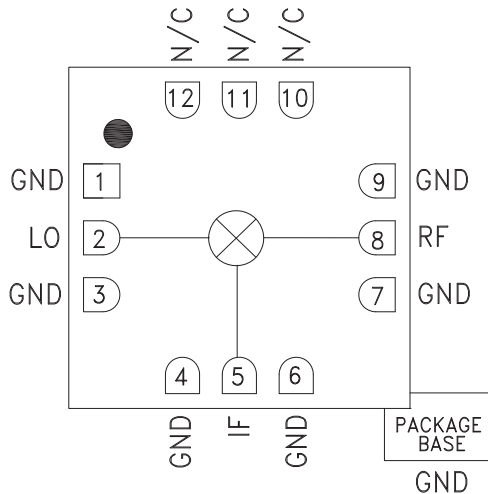

### General Description

The HMC554LC3B is a general purpose double balanced mixer in a leadless RoHS compliant SMT package that can be used as an upconverter or downconverter between 11 and 20 GHz. This mixer is fabricated in a GaAs MESFET process, and requires no external components or matching circuitry. The HMC554LC3B provides excellent LO to RF and LO to IF isolation due to optimized balun structures. The RoHS compliant HMC554LC3B eliminates the need for wire bonding, and is compatible with high volume surface mount manufacturing techniques.

### Electrical Specifications, $T_A = +25^\circ\text{C}$ , $IF = 100\text{ MHz}$ , $LO = +13\text{ dBm}^*$

Parameter	Min.	Typ.	Max.	Min.	Typ.	Max.	Units
Frequency Range, RF & LO	12 - 16			11 - 20			GHz
Frequency Range, IF	DC - 6			DC - 6			GHz
Conversion Loss		7	9		8	11	dB
Noise Figure (SSB)		7	9		8	11	dB
LO to RF Isolation	40	46		40	46		dB
LO to IF Isolation	34	40		30	40		dB
RF to IF Isolation	18	25		15	25		dB
IP3 (Input)		18			18		dBm
IP2 (Input)		48			45		dBm
1 dB Gain Compression (Input)		11			11		dBm

\*Unless otherwise noted, all measurements performed as downconverter, IF = 100 MHz.



**Conversion Gain vs. Temperature**  
@ LO = +13 dBm

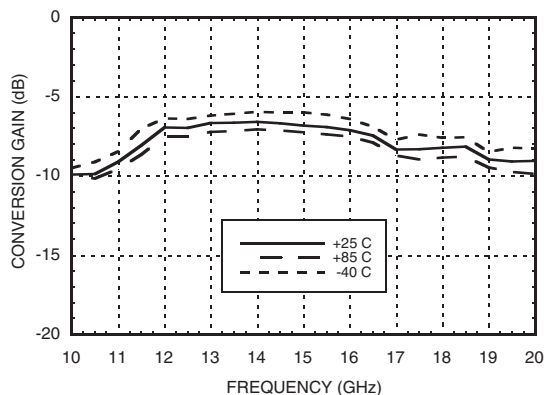

**Isolation @ LO = +13 dBm**

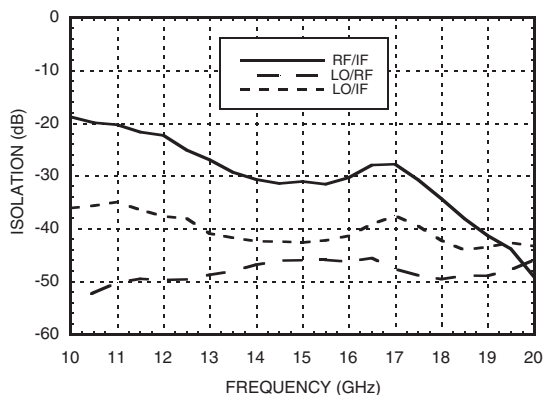

**Conversion Gain vs. LO Drive**

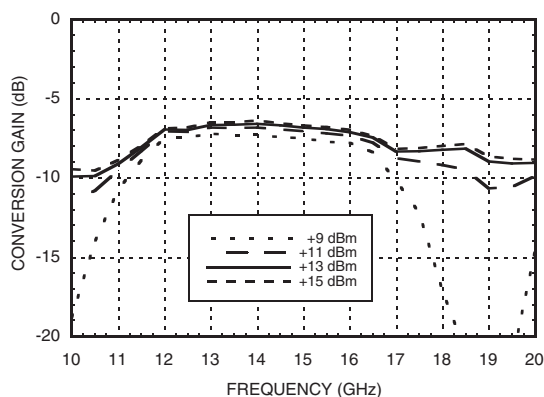

**Return Loss @ LO = +13 dBm**

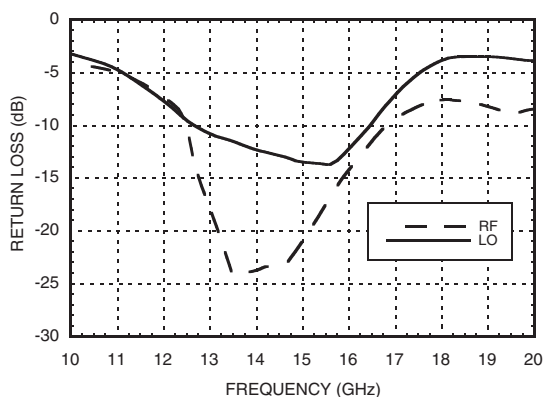

**IF Bandwidth @ LO = +13 dBm**

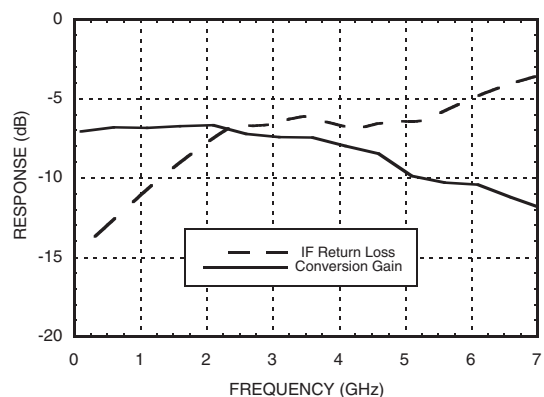

**Upconverter Performance**  
**Conversion Gain vs. LO Drive**

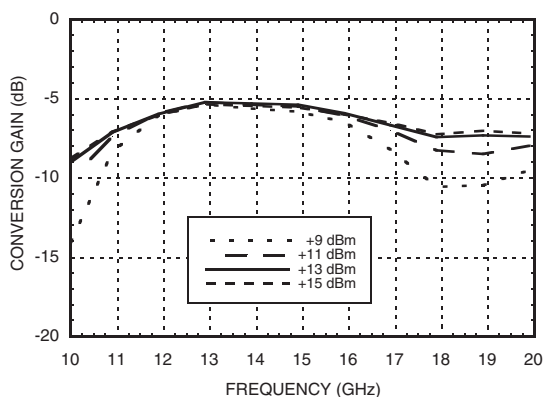



**Input IP3 vs. LO Drive \***

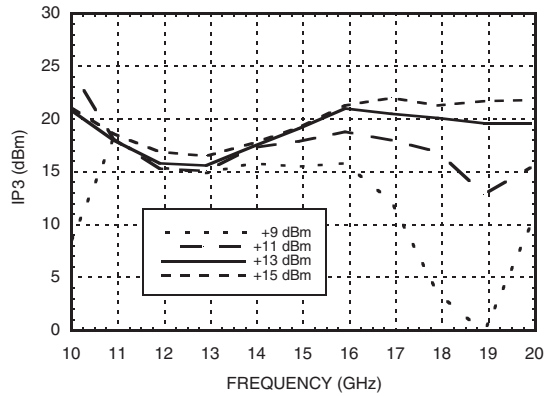

**Input IP3 vs. Temperature @ LO = +13 dBm\***

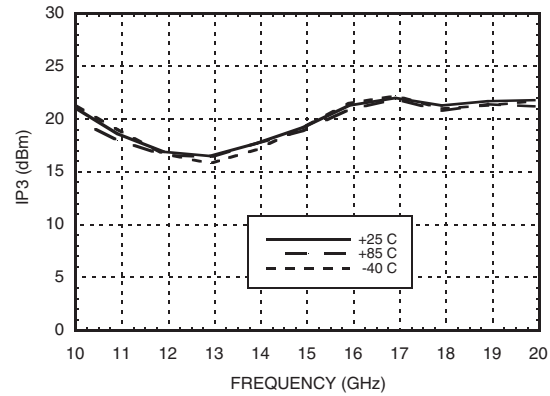

**Input IP2 vs. LO Drive \***

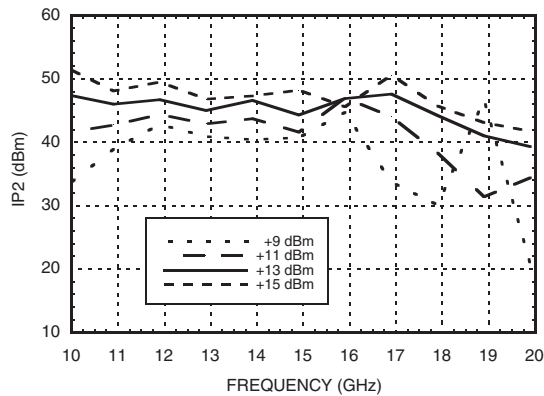

**Input IP2 vs. Temperature @ LO = +13 dBm\***

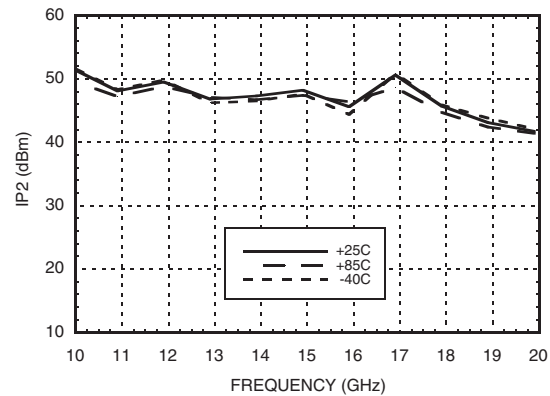

**Input P1dB vs. Temperature @ LO = +13 dBm**

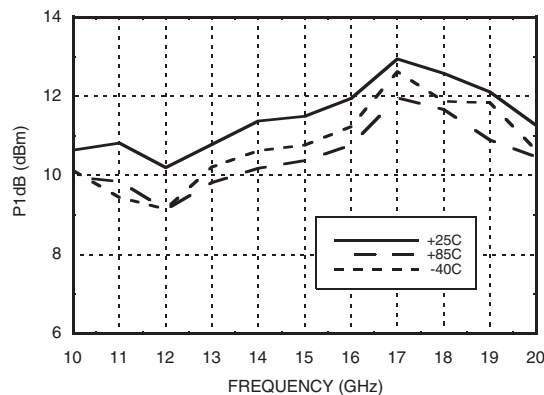

**MxN Spurious Outputs**

		nLO				
mRF		0	1	2	3	4
0		xx	19	25	xx	xx
1		29	0	51	55	xx
2		81	85	60	88	104
3		xx	97	98	76	99
4		xx	xx	105	98	105

RF = 15.1 GHz @ -10 dBm  
 LO = 15.0 GHz @ +13 dBm  
 All values in dBc below the IF output power level.

\* Two-tone input power = -10 dBm each tone, 1 MHz spacing.

**Absolute Maximum Ratings**

RF / IF Input	+25 dBm
LO Drive	+25 dBm
Channel Temperature	150 °C
Continuous Pdiss (T= 85 °C) (derate 2.32 mW/°C above 85 °C)	150 mW
Thermal Resistance (channel to ground paddle)	431 °C/W
Storage Temperature	-65 to +150 °C
Operating Temperature	-40 to +85 °C
ESD Sensitivity (HBM)	Class 1C

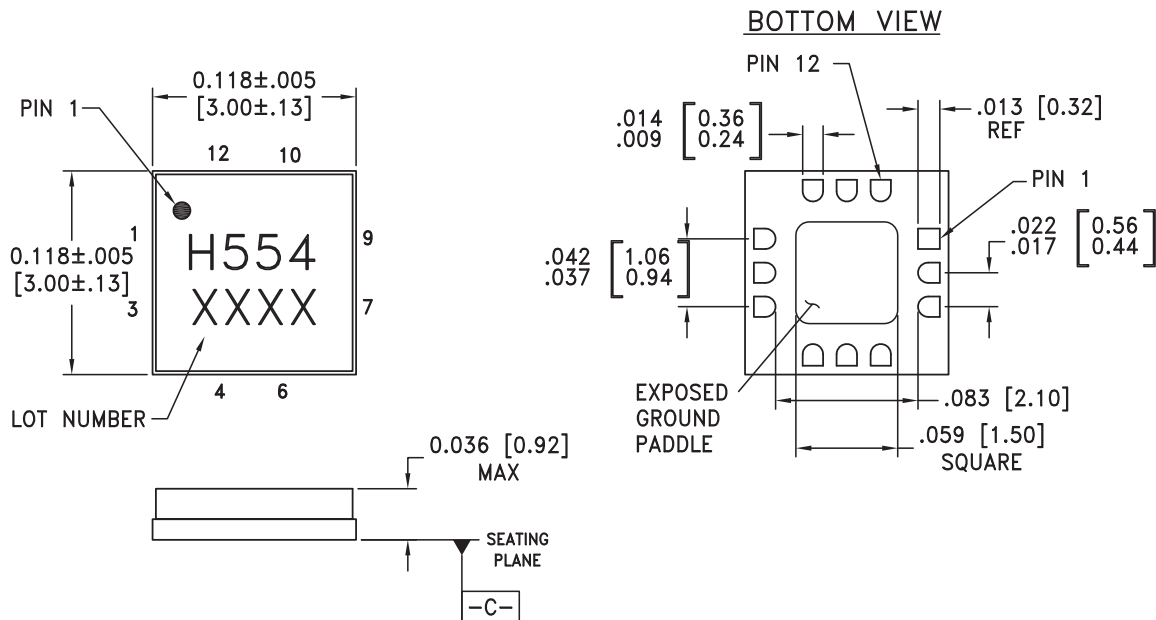

ELECTROSTATIC SENSITIVE DEVICE  
OBSERVE HANDLING PRECAUTIONS

**Outline Drawing**

**NOTES:**

1. PACKAGE BODY MATERIAL: ALUMINA.
2. LEAD AND GROUND PADDLE PLATING:  
30-80 MICROINCHES GOLD OVER 50 MICROINCHES MINIMUM NICKEL.
3. DIMENSIONS ARE IN INCHES (MILLIMETERS).
4. LEAD SPACING TOLERANCE IS NON-CUMULATIVE.
5. CHARACTERS TO BE HELVETICA MEDIUM, .025 HIGH, BLACK INK, OR LASER MARK LOCATED APPROX. AS SHOWN.
6. PACKAGE WARP SHALL NOT EXCEED 0.05MM DATUM - C -
7. ALL GROUND LEADS AND GROUND PADDLE MUST BE SOLDERED TO PCB RF GROUND.
8. CLASSIFIED AS MOISTURE SENSITIVITY LEVEL (MSL) 1.

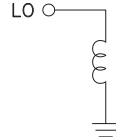
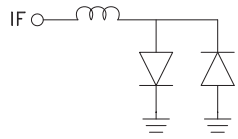
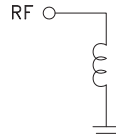
**Pin Descriptions**

Pin Number	Function	Description	Interface Schematic
1, 3, 4, 6, 7, 9	GND	Package bottom must also be connected to RF/DC ground.	
2	LO	This pin is DC coupled and matched to 50 Ohms.	
5	IF	This pin is DC coupled. For applications not requiring operation to DC, this port should be DC blocked externally using a series capacitor whose value has been chosen to pass the necessary IF frequency range. For operation to DC, this pin must not source or sink more than 2 mA of current or part non-function and possible part failure will result.	
8	RF	This pin is DC coupled and matched to 50 Ohms.	
10, 11, 12	N/C	No connection required. These pins may be connected to RF/DC ground without affecting performance.	

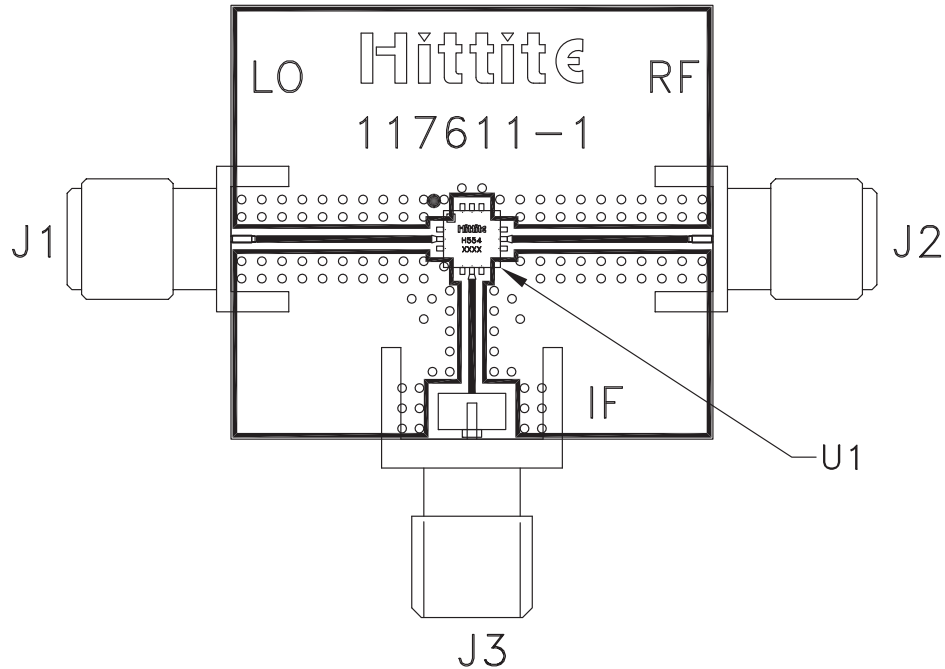
### Evaluation PCB



### List of Materials for Evaluation PCB 109952 [1]

Item	Description
J1 - J2	SRI SMA Connector
J3	Johnson SMA Connector
U1	HMC554LC3B Mixer
PCB [2]	117611 Evaluation PCB

[1] Reference this number when ordering complete evaluation PCB

[2] Circuit Board Material: Arlon 25 FR

The circuit board used in this application should use RF circuit design techniques. Signal lines should have 50 ohm impedance while the package ground leads and exposed paddle should be connected directly to the ground plane similar to that shown. A sufficient number of via holes should be used to connect the top and bottom ground planes. The evaluation circuit board shown is available from Hittite upon request.