

Features

- $S_{21} = 19.0 \text{ dB @ } 940 \text{ MHz}$
= $16.0 \text{ dB @ } 1500 \text{ MHz}$
- NF of 0.65 dB over Frequency
- Unconditionally Stable
- Single 5V Supply
- High OIP3 @ Low Current

Description

The plerow™ ALN-series is the compactly designed surface-mount module for the use of the LNA with or without the following gain blocks in the infrastructure equipment of the mobile wireless (CDMA, GSM, PCS, PHS, WCDMA, DMB, WLAN, WiBro, WiMAX), GPS, satellite communication terminals, CATV and so on. It has an exceptional performance of low noise figure, high gain, high OIP3, and low bias current. The stability factor is always kept more than unity over the application band in order to ensure its unconditionally stable implementation to the application system environment. The surface-mount module package including the completed matching circuit and other components necessary just in case allows very simple and convenient implementation onto the system board in mass production level.

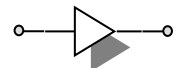

1-stage Single Type

Specifications (in Production)

Typ. @ T = 25°C, $V_s = 5 \text{ V}$, Freq. = 1220 MHz, $Z_{o,sys} = 50 \text{ ohm}$

Parameter	Unit	Specifications		
		Min	Typ	Max
Frequency Range	MHz	940		1500
Gain	dB	16.5	17.5	
Gain Flatness	dB		± 1.5	± 1.6
Noise Figure	dB		0.65	0.70
Output IP3 ⁽¹⁾	dBm	27	28	
S11 / S22 ⁽²⁾	dB			-13 / -8
Output P1dB	dBm	14	15	
Switching Time ⁽³⁾	μsec			
Supply Current	mA		40	60
Supply Voltage	V		5	
Impedance	Ω		50	
Max. RF Input Power	dBm	C.W 29 ~ 31 (before fail)		
Package Type & Size	mm	Surface Mount Type, 10Wx10Lx3.8H		

Operating temperature is -40°C to +85°C.

1) OIP3 is measured with two tones at an output power of +0 dBm / tone separated by 1 MHz.

2) S11/S22 (max) is the worst value within the frequency band.

3) Switching time means the time that takes for output power to get stabilized to its final level after switching DC voltage from 0 V to V_s .

More Information

Website: www.asb.co.kr
E-mail: sales@asb.co.kr

Tel: (82) 42-528-7223
Fax: (82) 42-528-7222

Outline Drawing (Unit: mm)

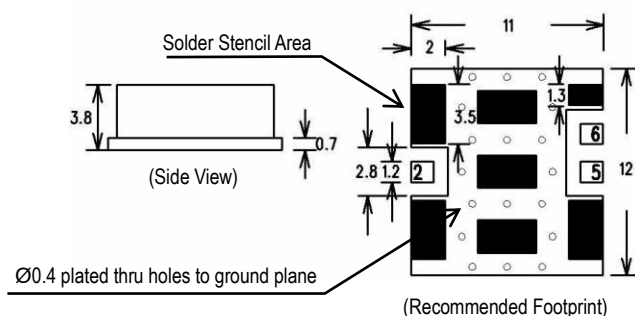
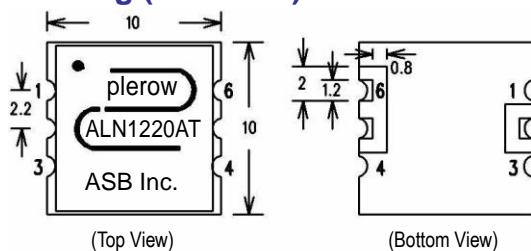

Pin Number	Function
2	RF In
5	RF Out
6	V_s
Others	Ground

Note: 1. The number and size of ground via holes in a circuit board is critical for thermal RF grounding considerations.

2. We recommend that the ground via holes be placed on the bottom of all ground pins for better RF and thermal performance, as shown in the drawing at the left side.

**Typical Performance
(Measured)**

940~1500 MHz

+5 V

S-parameters

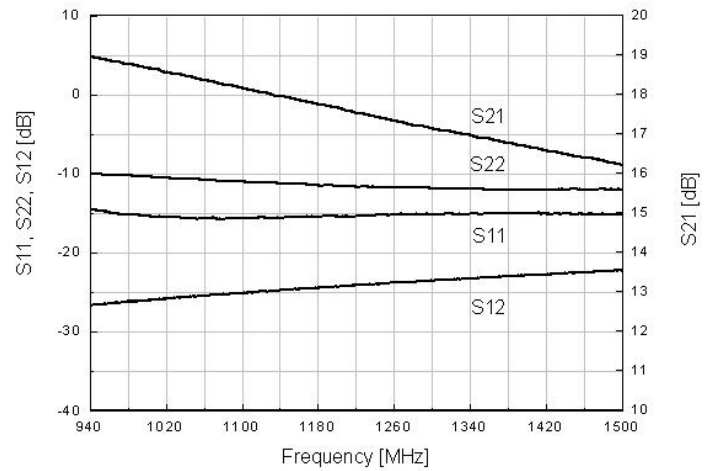

S-parameters & K Factor

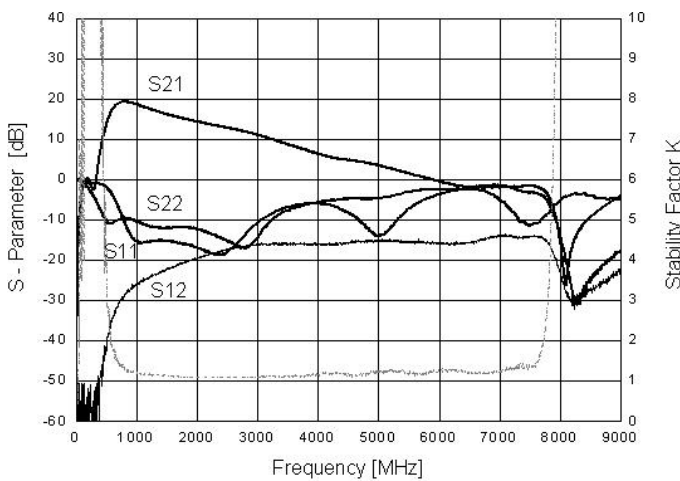

Noise Figure

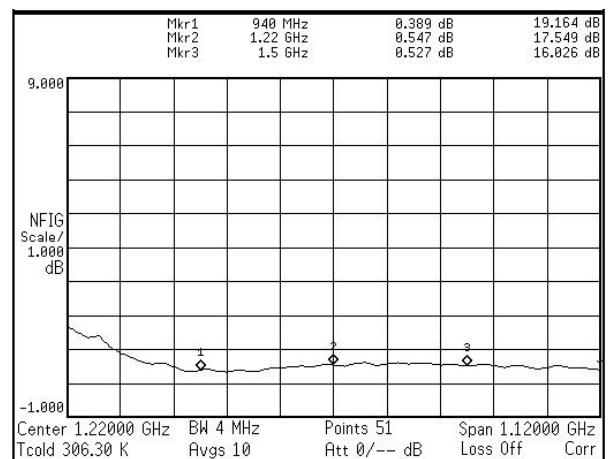

OIP3

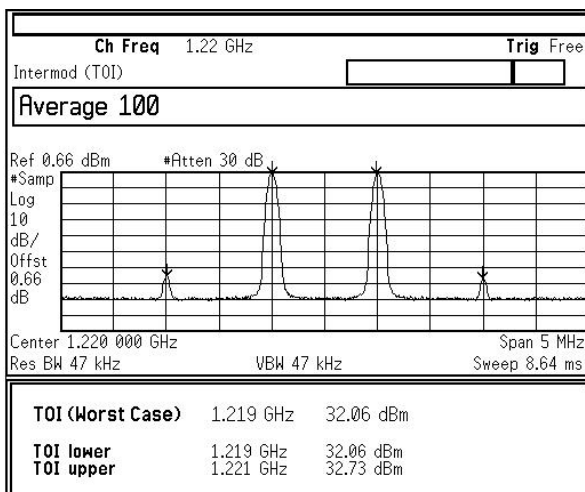

P1dB

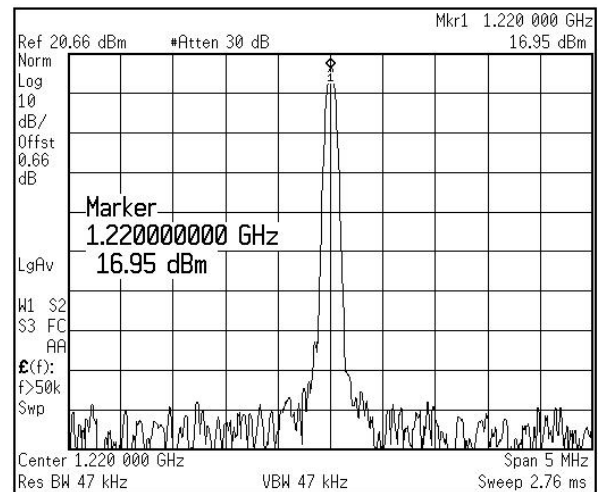

RF Performance with Voltage Change

1. S-parameter

	940 MHz			1220 MHz				1500 MHz		
	S21 (dB)	S11 (dB)	S22 (dB)	S21 (dB)	G/F (dB)	S11 (dB)	S22 (dB)	S21 (dB)	S11 (dB)	S22 (dB)
4.50 V	18.86	-13.77	-9.652	17.42	2.76	-14.66	-11.46	16.10	-14.62	-12.03
4.75 V	18.91	-14.16	-9.841	17.47	2.75	-15.04	-11.58	16.16	-14.95	-12.02
5.00 V	18.94	-14.47	-9.995	17.51	2.75	-15.40	-11.67	16.19	-15.26	-12.01
5.25 V	18.97	-14.79	-10.12	17.53	2.75	-15.73	-11.76	16.22	-15.50	-11.95
5.50 V	18.99	-15.06	-10.26	17.55	2.75	-16.00	-11.86	16.24	-15.75	-11.88

2. OIP3, P1dB & NF

	940 MHz			1220 MHz			1500 MHz		
	OIP3 (dBm)	P1dB (dBm)	NF (dB)	OIP3 (dBm)	P1dB (dBm)	NF (dB)	OIP3 (dBm)	P1dB (dBm)	NF (dB)
4.50 V	27.62	14.70	0.380	30.47	15.83	0.577	31.26	16.51	0.527
4.75 V	28.75	15.45	0.390	31.50	16.25	0.570	32.07	17.11	0.537
5.00 V	29.10	16.06	0.398	32.06	16.95	0.547	32.74	17.60	0.527
5.25 V	29.44	16.52	0.417	32.47	17.20	0.570	33.15	18.05	0.531
5.50 V	29.87	17.00	0.422	32.96	17.85	0.565	33.51	18.45	0.545

Note: tested at room temperature.

RF Performance with Operating Temperature

1. S-parameter

	940 MHz			1220 MHz				1500 MHz		
	S21 (dB)	S11 (dB)	S22 (dB)	S21 (dB)	G/F (dB)	S11 (dB)	S22 (dB)	S21 (dB)	S11 (dB)	S22 (dB)
-45 °C	19.16	-13.02	-10.62	17.75	2.70	-15.85	-11.37	16.46	-17.38	-11.29
-10 °C	19.04	-13.95	-10.20	17.65	2.71	-15.62	-11.40	16.33	-16.29	-11.97
25 °C	18.94	-14.33	-9.947	17.53	2.70	-14.92	-11.30	16.24	-15.05	-12.10
60 °C	18.82	-14.56	-9.752	17.40	2.71	-14.57	-11.12	16.11	-14.66	-11.95
85 °C	18.67	-14.72	-9.664	17.24	2.71	-14.25	-11.05	15.96	-14.24	-11.83

2. OIP3, P1dB & NF

	940 MHz			1220 MHz			1500 MHz		
	OIP3 (dBm)	P1dB (dBm)	NF (dB)	OIP3 (dBm)	P1dB (dBm)	NF (dB)	OIP3 (dBm)	P1dB (dBm)	NF (dB)
-45 °C	29.48	16.17	0.297	31.70	16.93	0.384	32.85	17.46	0.378
-10 °C	29.45	16.20	0.404	31.55	16.94	0.556	32.78	17.40	0.542
25 °C	29.35	16.26	0.450	31.45	16.96	0.579	32.75	17.38	0.603
60 °C	28.84	16.05	0.650	31.20	16.72	0.684	32.70	17.12	0.725
85 °C	28.35	15.87	0.772	30.76	16.51	0.784	32.15	16.67	0.805

Note: tested at $V_s = 5V$.

Application Circuit

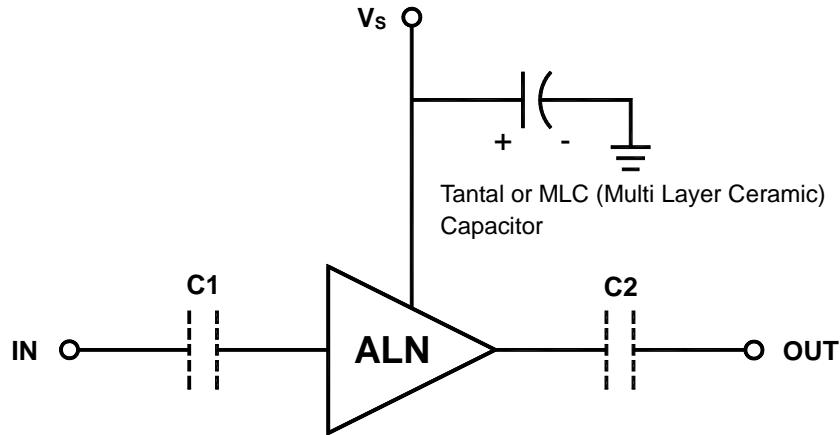

- 1) The tantalum or MLC (Multi Layer Ceramic) capacitor is optional and for bypassing the AC noise introduced from the DC supply. The capacitance value may be determined by customer's DC supply status. The capacitor should be placed as close as possible to V_s pin and be connected directly to the ground plane for the best electrical performance.
- 2) DC blocking capacitors are always necessarily placed at the input and output port for allowing only the RF signal to pass and blocking the DC component in the signal. The DC blocking capacitors are included inside the ALN module. Therefore, C1 & C2 capacitors may not be necessary, but can be added just in case that the customer wants. The value of C1 & C2 is determined by considering the application frequency.

Recommended Soldering Reflow Process

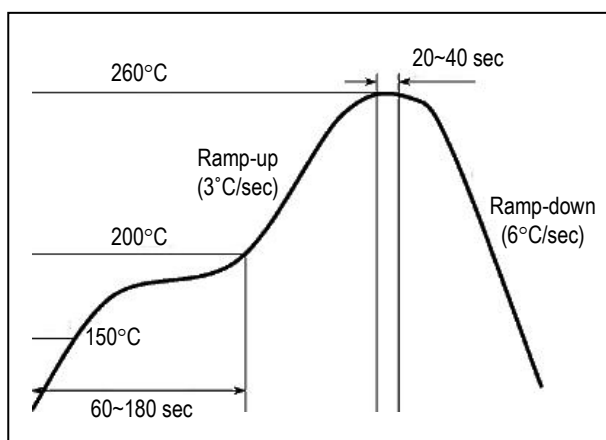

Evaluation Board Layout

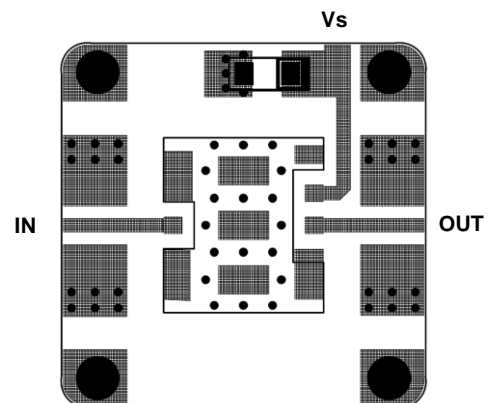

Size 25x25mm
(for ALN-AT, BT, T Series – 10x10mm)