

P-Channel MOSFET

2SJ602-ZJ

■ Features

- $V_{DS} (V) = -60V$
- $I_D = -20A$
- $R_{DS(ON)} < 73m\ \Omega$ ($V_{GS} = -10V$)
- $R_{DS(ON)} < 107m\ \Omega$ ($V_{GS} = -4V$)
- Low Ciss: Ciss = 1300 pF (TYP.)

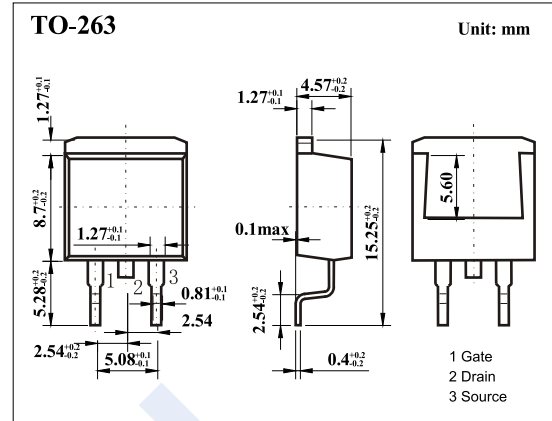
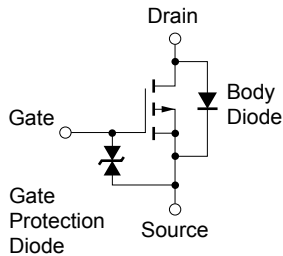

■ Absolute Maximum Ratings $T_a = 25^\circ C$

Parameter	Symbol	Rating	Unit
Drain-Source Voltage	V_{DS}	-60	V
Gate-Source Voltage	V_{GS}	± 20	
Continuous Drain Current	I_D	-20	A
Pulsed Drain Current (Note.1)	I_{DM}	-50	
Single Avalanche Current (Note.2)	I_{AS}	-20	
Power Dissipation	P_D	40	W
		1.5	
Single Avalanche Energy (Note.2)	E_{AS}	40	mJ
Junction Temperature	T_J	150	$^\circ C$
Junction Storage Temperature Range	T_{stg}	-55 to 150	

Note.1: $PW \leq 10\mu s$, Duty Cycle $\leq 1\%$

Note.2: Starting $T_J = 25^\circ C$, $V_{DD} = -30V$, $R_G = 25\ \Omega$, $V_{GS} = -20V \rightarrow 0$

P-Channel MOSFET

2SJ602-ZJ

■ Electrical Characteristics Ta = 25°C

Parameter	Symbol	Test Conditions	Min	Typ	Max	Unit
Drain-Source Breakdown Voltage	V _{DSS}	I _D =-250 μA, V _{GS} =0V	-60			V
Zero Gate Voltage Drain Current	I _{DSS}	V _{DS} =-60V, V _{GS} =0V			-10	μA
Gate-Body leakage current	I _{GSS}	V _{DS} =0V, V _{GS} =±20V			±10	μA
Gate Cut off Voltage	V _{GS(off)}	V _{DS} =-10V, I _D =-1mA	-1.5		-2.5	V
Static Drain-Source On-Resistance	R _{DS(on)}	V _{GS} =-10V, I _D =-10A			73	mΩ
		V _{GS} =-4V, I _D =-10A			107	
Forward Transconductance	g _{FS}	V _{DS} =-10V, I _D =-10A	8	16		S
Input Capacitance	C _{iss}	V _{GS} =0V, V _{DS} =-10V, f=1MHz		1300		pF
Output Capacitance	C _{oss}			240		
Reverse Transfer Capacitance	C _{rss}			100		
Total Gate Charge	Q _g	V _{GS} =-10V, V _{DS} =-48V, I _D =-20A		26		nC
Gate Source Charge	Q _{gs}			5		
Gate Drain Charge	Q _{gd}			7		
Turn-On DelayTime	t _{d(on)}	V _{GS(on)} =-10V, V _{DS} =-30V, I _D =-10A, R _G =0Ω		9		ns
Turn-On Rise Time	t _r			12		
Turn-Off DelayTime	t _{d(off)}			54		
Turn-Off Fall Time	t _f			15		
Body Diode Reverse Recovery Time	t _{rr}	I _F =-20A, V _{GS} =0, di/dt=100A/μs		50		ns
Body Diode Reverse Recovery Charge	Q _{rr}			110		
Diode Forward Voltage	V _{SD}	I _F =-20A, V _{GS} =0V		-1		V

■ Typical Characteristics

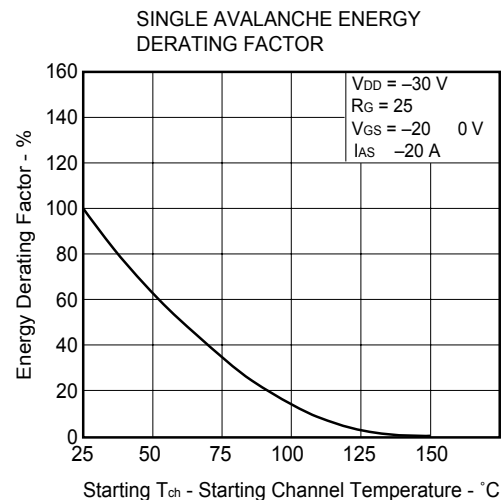
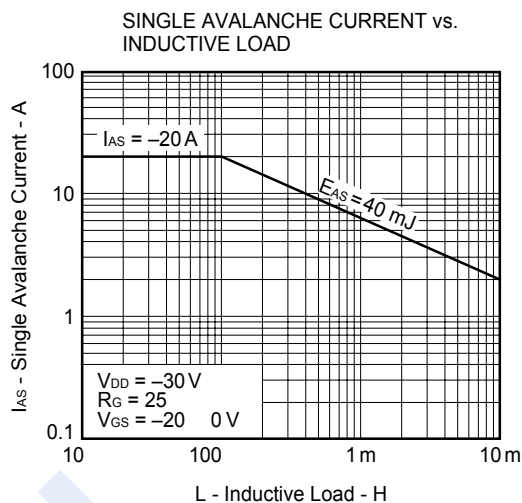

P-Channel MOSFET 2SJ602-ZJ

Typical Characteristics

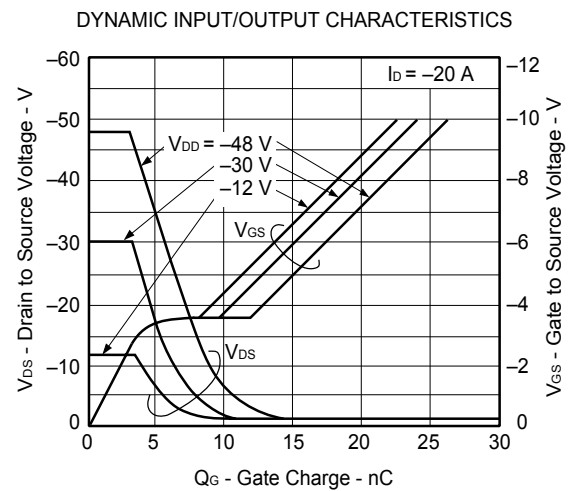
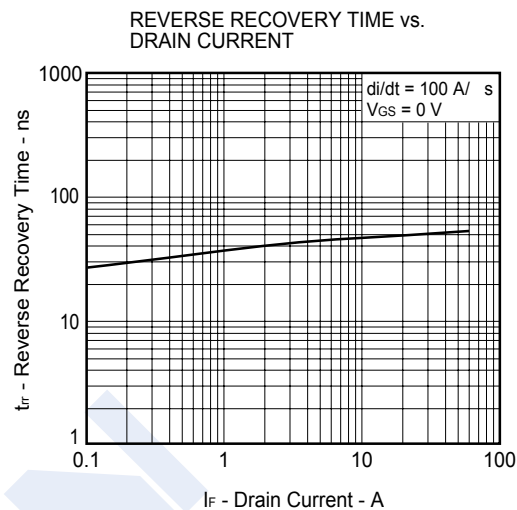
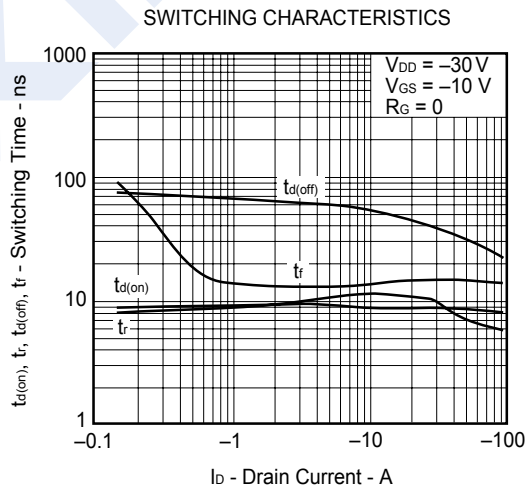
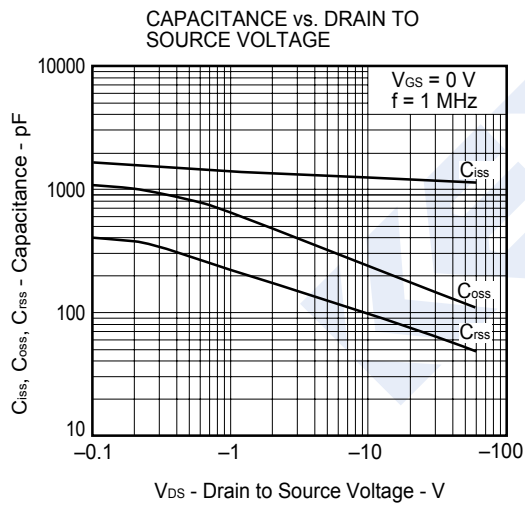
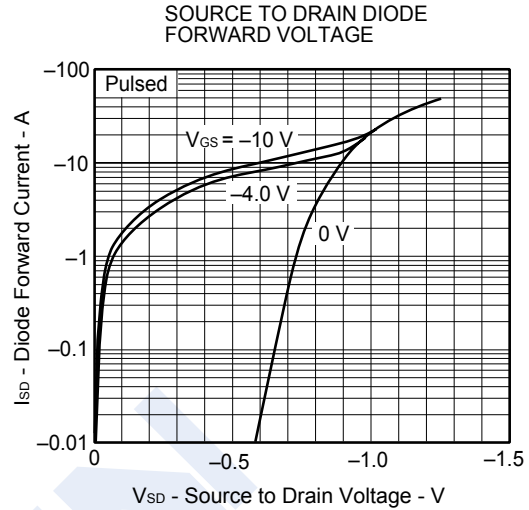
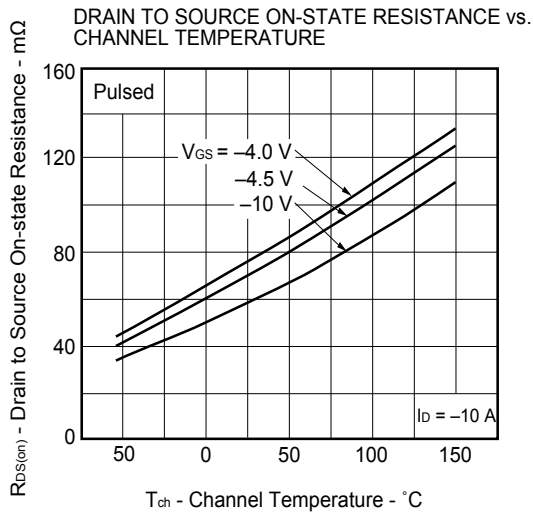

P-Channel MOSFET 2SJ602-ZJ

Typical Characteristics

FORWARD TRANSFER CHARACTERISTICS

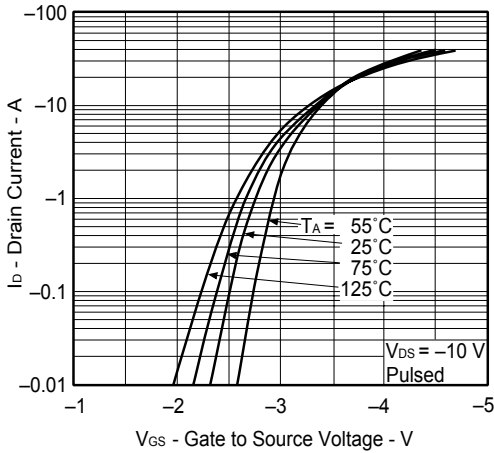

DRAIN CURRENT vs. DRAIN TO SOURCE VOLTAGE

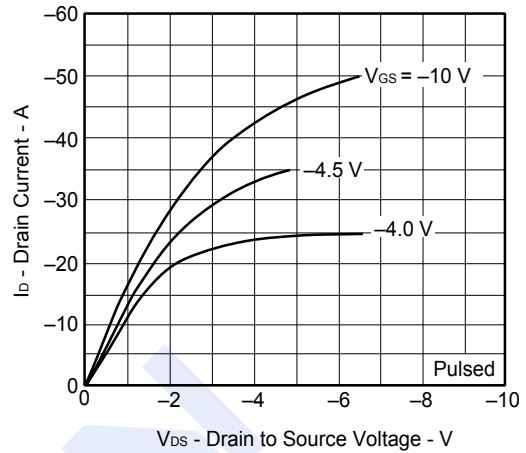

FORWARD TRANSFER ADMITTANCE vs. DRAIN CURRENT

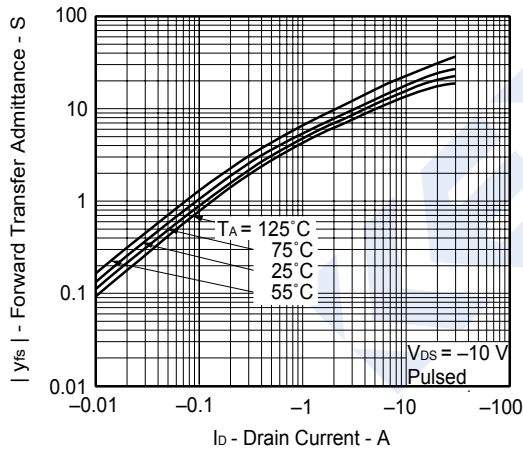

DRAIN TO SOURCE ON-STATE RESISTANCE vs. GATE TO SOURCE VOLTAGE

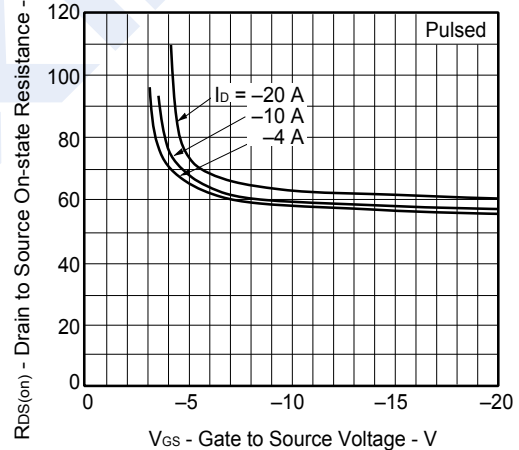

DRAIN TO SOURCE ON-STATE RESISTANCE vs. DRAIN CURRENT

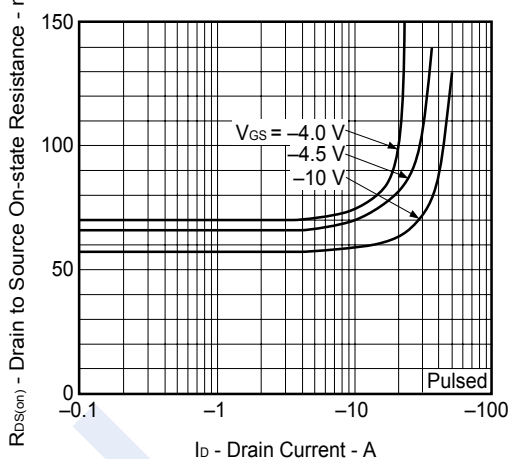

GATE CUT-OFF VOLTAGE vs. CHANNEL TEMPERATURE

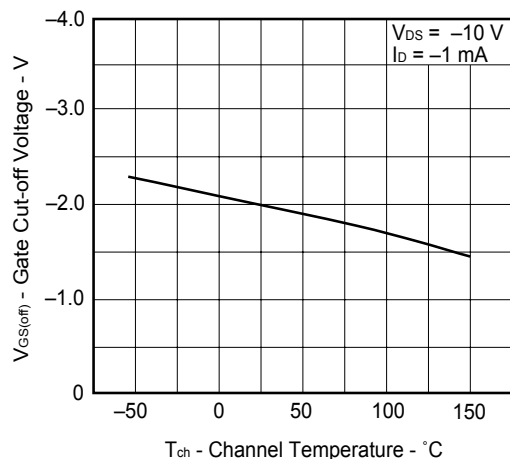

P-Channel MOSFET 2SJ602-ZJ

Typical Characteristics

DERATING FACTOR OF FORWARD BIAS
SAFE OPERATING AREA

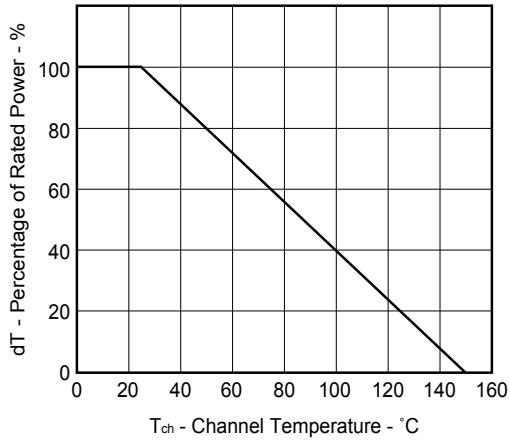

TOTAL POWER DISSIPATION vs.
CASE TEMPERATURE

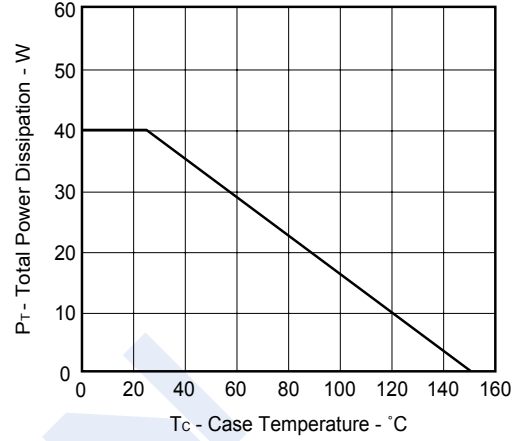

FORWARD BIAS SAFE OPERATING AREA

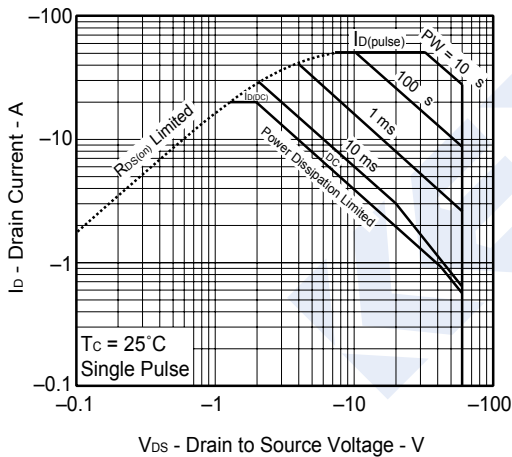

TRANSIENT THERMAL RESISTANCE vs. PULSE WIDTH

