

# N-CHANNEL POWER MOSFET

## LBSS123LT1G

### FEATURE

- Pb-Free Package is available.
- S- Prefix for Automotive and Other Applications Requiring Unique Site and Control Change Requirements; AEC-Q101 Qualified and PPAP Capable.

### DEVICE MARKING AND ORDERING INFORMATION

Device	Marking	Shipping
LBSS123LT1G S-LBSS123LT1G	SA	3000/Tape&Reel
LBSS123LT3G S-LBSS123LT3G	SA	10000/Tape&Reel

### MAXIMUM RATINGS

Rating	Symbol	Value	Unit
Drain-Source Voltage	$V_{DSS}$	100	Vdc
Gate-Source Voltage	$V_{GS}$	$\pm 20$	Vdc
- Continuous	$V_{GSM}$	$\pm 40$	Vpk
- Non-repetitive ( $t_p \leq 50 \mu s$ )			
Drain Current	$I_D$	0.17	Adc
Continuous (Note 1.)	$I_{DM}$	0.68	
Pulsed (Note 2.)			

### THERMAL CHARACTERISTICS

Characteristic	Symbol	Max	Unit
Total Device Dissipation FR-5 Board (Note 3.)	$P_D$	225	mW
$T_A = 25^\circ C$		1.8	mW/ $^\circ C$
Derate above $25^\circ C$			
Thermal Resistance, Junction to Ambient	$R_{\theta JA}$	556	$^\circ C/W$
Junction and Storage Temperature	$T_J, T_{stg}$	-55 to +150	$^\circ C$

1. The Power Dissipation of the package may result in a lower continuous drain current.
2. Pulse Width  $\leq 300 \mu s$ , Duty Cycle  $\leq 2.0\%$ .
3. FR-5 =  $1.0 \times 0.75 \times 0.062$  in.

## LBSS123LT1G S-LBSS123LT1G

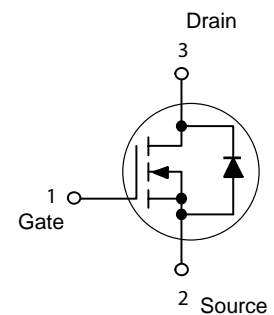
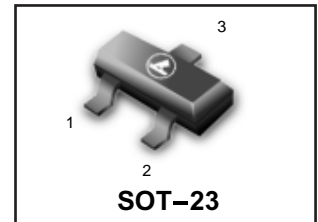

**LBSS123LT1G , S-LBSS123LT1G**
**ELECTRICAL CHARACTERISTICS** ( $T_A = 25^\circ\text{C}$  unless otherwise noted)

Characteristic	Symbol	Min	Typ	Max	Unit
----------------	--------	-----	-----	-----	------

**OFF CHARACTERISTICS**

Drain–Source Breakdown Voltage ( $V_{GS} = 0, I_D = 250 \mu\text{Adc}$ )	$V_{(BR)DSS}$	100	–	–	Vdc
Zero Gate Voltage Drain Current ( $V_{GS} = 0, V_{DS} = 100 \text{Vdc}$ ) $T_J = 25^\circ\text{C}$ $T_J = 125^\circ\text{C}$	$I_{DSS}$	–	–	15 60	$\mu\text{Adc}$
Gate–Body Leakage Current ( $V_{GS} = 20 \text{Vdc}, V_{DS} = 0$ )	$I_{GSS}$	–	–	50	nAdc

**ON CHARACTERISTICS** (Note 4.)

Gate Threshold Voltage ( $V_{DS} = V_{GS}, I_D = 1.0 \text{mAdc}$ )	$V_{GS(th)}$	0.8	–	2.0	Vdc
Static Drain–Source On–Resistance ( $V_{GS} = 10 \text{Vdc}, I_D = 100 \text{mAdc}$ )	$r_{DS(on)}$	–	5.0	6.0	$\Omega$
Forward Transconductance ( $V_{DS} = 25 \text{Vdc}, I_D = 100 \text{mAdc}$ )	$g_{fs}$	80	–	–	mmhos

**DYNAMIC CHARACTERISTICS**

Input Capacitance ( $V_{DS} = 25 \text{Vdc}, V_{GS} = 0, f = 1.0 \text{MHz}$ )	$C_{iss}$	–	20	–	pF
Output Capacitance ( $V_{DS} = 25 \text{Vdc}, V_{GS} = 0, f = 1.0 \text{MHz}$ )	$C_{oss}$	–	9.0	–	pF
Reverse Transfer Capacitance ( $V_{DS} = 25 \text{Vdc}, V_{GS} = 0, f = 1.0 \text{MHz}$ )	$C_{rss}$	–	4.0	–	pF

**SWITCHING CHARACTERISTICS(4)**

Turn–On Delay Time	( $V_{CC} = 30 \text{Vdc}, I_C = 0.28 \text{Adc},$ $V_{GS} = 10 \text{Vdc}, R_{GS} = 50 \Omega$ )	$t_{d(on)}$	–	20	–	ns
Turn–Off Delay Time		$t_{d(off)}$	–	40	–	ns

**REVERSE DIODE**

Diode Forward On–Voltage ( $I_D = 0.34 \text{Adc}, V_{GS} = 0 \text{Vdc}$ )	$V_{SD}$	–	–	1.3	V
--	----------	---	---	-----	---

4. Pulse Test: Pulse Width  $\leq 300 \mu\text{s}$ , Duty Cycle  $\leq 2.0\%$ .

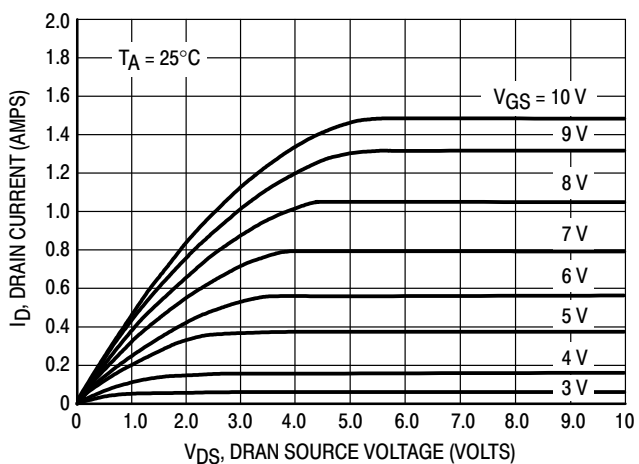
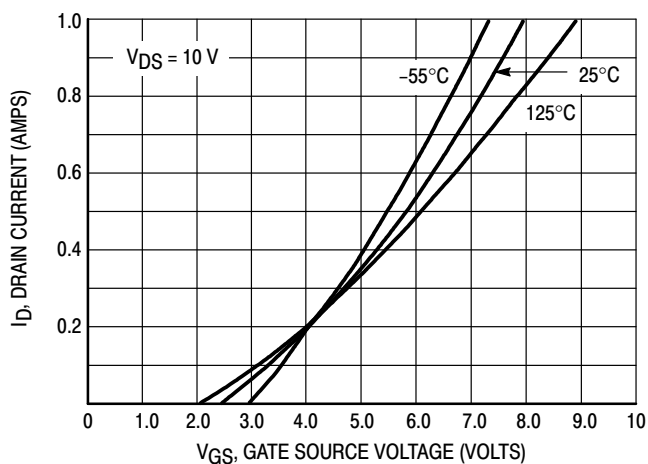
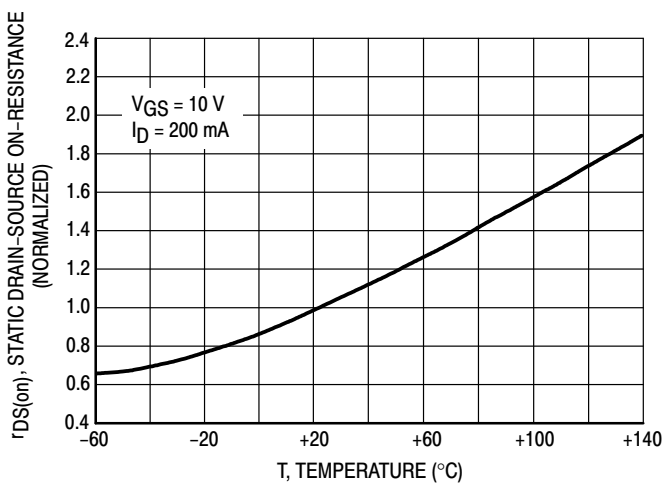
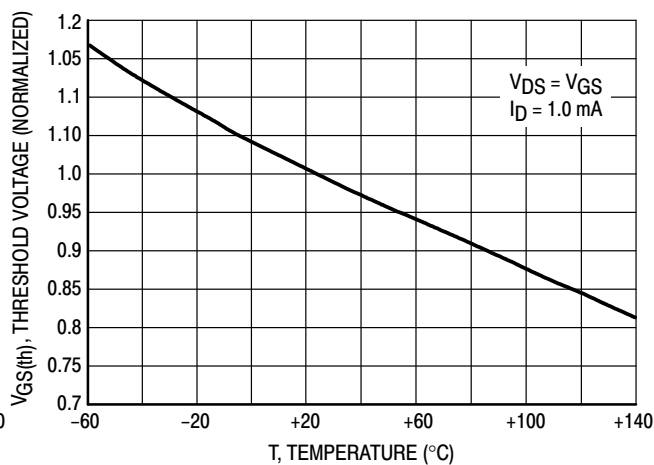
**LBSS123LT1G , S-LBSS123LT1G**
**TYPICAL ELECTRICAL CHARACTERISTICS**

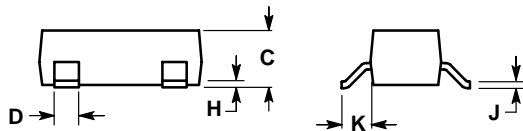
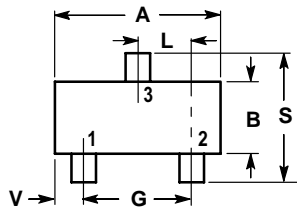
**Figure 1. Ohmic Region**

**Figure 2. Transfer Characteristics**

**Figure 3. Temperature versus Static Drain-Source On-Resistance**

**Figure 4. Temperature versus Gate Threshold Voltage**

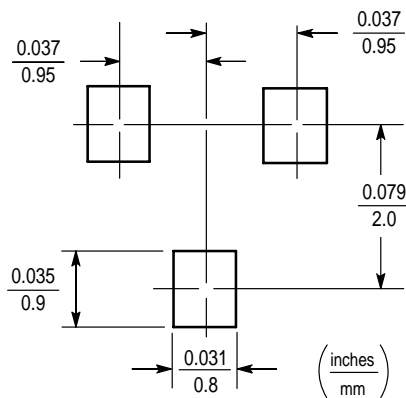
**LBSS123LT1G , S-LBSS123LT1G**
**SOT-23**

**NOTES:**

1. DIMENSIONING AND TOLERANCING PER ANSI Y14.5M, 1982.
2. CONTROLLING DIMENSION: INCH.

DIM	INCHES		MILLIMETERS	
	MIN	MAX	MIN	MAX
A	0.1102	0.1197	2.80	3.04
B	0.0472	0.0551	1.20	1.40
C	0.0350	0.0440	0.89	1.11
D	0.0150	0.0200	0.37	0.50
G	0.0701	0.0807	1.78	2.04
H	0.0005	0.0040	0.013	0.100
J	0.0034	0.0070	0.085	0.177
K	0.0140	0.0285	0.35	0.69
L	0.0350	0.0401	0.89	1.02
S	0.0830	0.1039	2.10	2.64
V	0.0177	0.0236	0.45	0.60

- PIN 1. Gate  
 2. Source  
 3. Drain



## EMBOSSED TAPE AND REEL DATA FOR DISCRETES

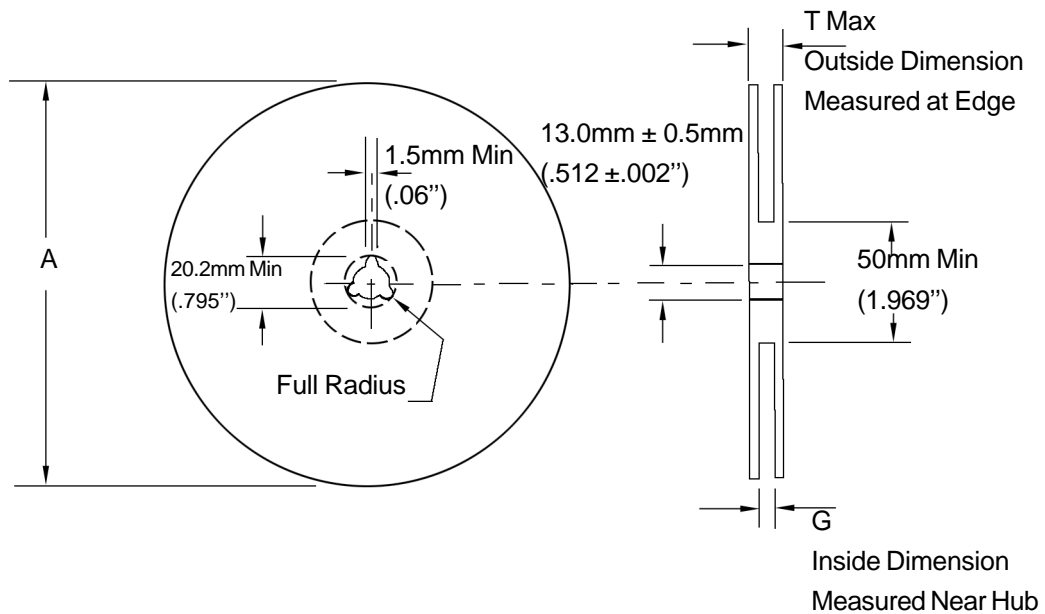

Size	A Max	G	T Max
8 mm	330mm (12.992")	8.4mm+1.5mm, -0.0 (.33"+.059", -0.00)	14.4mm (.56")
12mm	330mm (12.992")	12.4mm+2.0mm, -0.0 (.49 "+ .079", -0.00)	18.4mm (.72")
16mm	360mm (14.173")	16.4mm+2.0mm, -0.0 (.646"+.078", -0.00)	22.4mm (.882")
24 mm	360mm (14.173")	24.4mm+2.0mm, -0.0 (.961"+.070", -0.00)	30.4mm (1.197")

### Reel Dimensions

Metric Dimensions Govern — English are in parentheses for reference only

#### Storage Conditions

Temperature: 5 to 40 Deg.C (20 to 30 Deg. C is preferred)

Humidity: 30 to 80 RH (40 to 60 is preferred)

Recommended Period: One year after manufacturing

(This recommended period is for the soldering condition only. The characteristics and reliabilities of the products are not restricted to this limitation)

## Shipment Specification

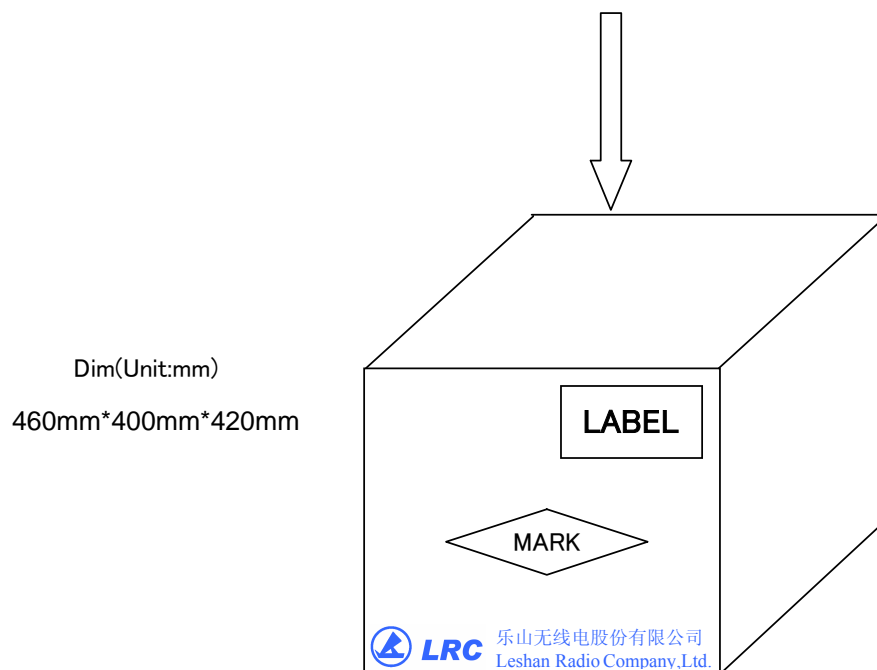
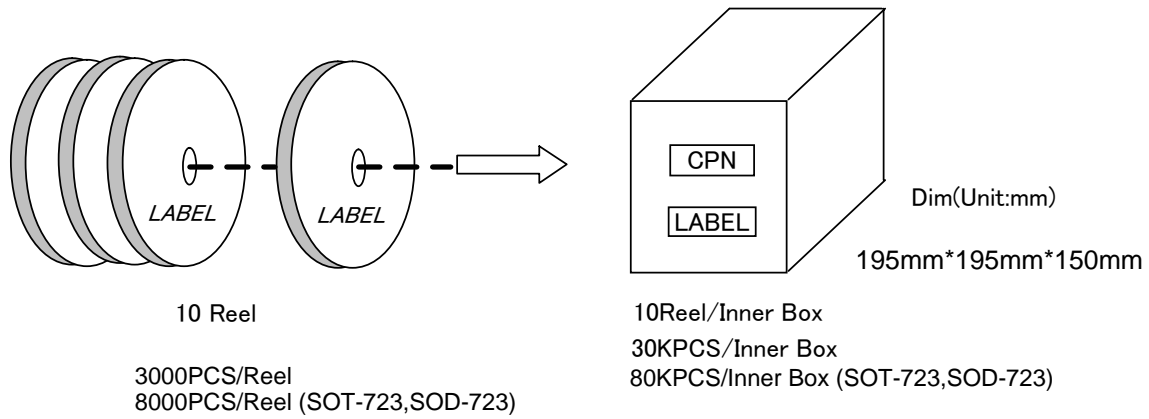

12 Inner Box/Carton

360KPCS/Carton  
960KPCS/Carton (SOT-723,SOD-723)