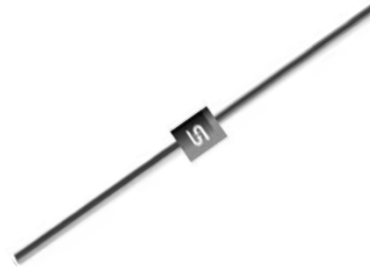

Schottky Barrier Rectifier

FEATURES

- Low forward voltage drop
- Low power loss, high efficiency
- Guardring for overvoltage protection
- High surge current capability
- For use as Bypass diode in Solar application.
- Compliant to RoHS Directive 2011/65/EU and in accordance to WEEE 2002/96/EC
- Halogen-free according to IEC 61249-2-21 definition

R-6

MECHANICAL DATA

Case: R-6

Molding compound, UL flammability classification rating 94V-0

Base P/N with suffix "G" on packing code - halogen-free

Base P/N with prefix "H" on packing code - AEC-Q101 qualified

Terminal: Matte tin plated leads, solderable per JESD22-B102

Meet JESD 201 class 1A whisker test,

with prefix "H" on packing code meet JESD 201 class 2 whisker test

Weight: 1.7 g (approximately)

MAXIMUM RATINGS AND ELECTRICAL CHARACTERISTICS (T _A =25°C unless otherwise noted)					
PARAMETER	SYMBOL	SR1502	SR1503	SR1504	UNIT
Maximum repetitive peak reverse voltage	V _{RRM}	20	30	40	V
Maximum RMS voltage	V _{RMS}	14	21	28	V
Maximum DC blocking voltage	V _{DC}	20	30	40	V
Maximum average forward rectified current	I _{F(AV)}	15			A
Repetitive peak forward current f > 15Hz	I _{FRM}	60			A
Peak forward surge current, 50/60 Hz single half sine-wave superimposed on rated load (JEDEC Method)	I _{FSM}	300 / 340			A
Rating for fusing t < 10ms	I ² t	390			A ² s
Maximum instantaneous forward voltage @5 A (Note 1) @15 A	V _F	0.45 0.55			V
Maximum DC reverse current @T _J =25 °C at rated DC blocking voltage @T _J =100 °C	I _R	500 20			μA mA
Typical thermal resistance	R _{θJL} R _{θJA}	2.5 25			°C/W
Junction temperature range - in DC forward mode	T _J	- 50 to +150 ≤200			°C
Storage temperature range	T _{STG}	- 55 to +175			°C

Note 1: Pulse test with PW=300μs, 1% duty cycle

ORDERING INFORMATION					
PART NO.	AEC-Q101 QUALIFIED	PACKING CODE	GREEN COMPOUND CODE	PACKAGE	PACKING
SR15xx (Note 1)	Prefix "H"	A0	Suffix "G"	R-6	700 / Ammo box
		R0		R-6	1,000 / 13" Paper reel
		B0		R-6	400 / Bulk packing

Note 1: "xx" defines voltage from 20V (SR1502) to 40V (SR1504)

EXAMPLE					
PREFERRED P/N	PART NO.	AEC-Q101 QUALIFIED	PACKING CODE	GREEN COMPOUND CODE	DESCRIPTION
SR1504 A0	SR1504		A0		
SR1504 A0G	SR1504		A0	G	Green compound
SR1504HA0	SR1504	H	A0		AEC-Q101 qualified

RATINGS AND CHARACTERISTICS CURVES

(TA=25°C unless otherwise noted)

FIG.1 RATED FORWARD CURRENT VS AMBIENT TEMP. CURVE

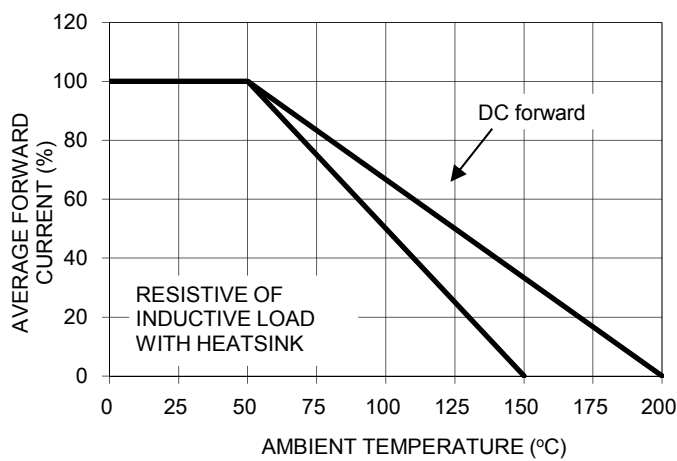

FIG. 2 MAXIMUM FORWARD SURGE CURRENT

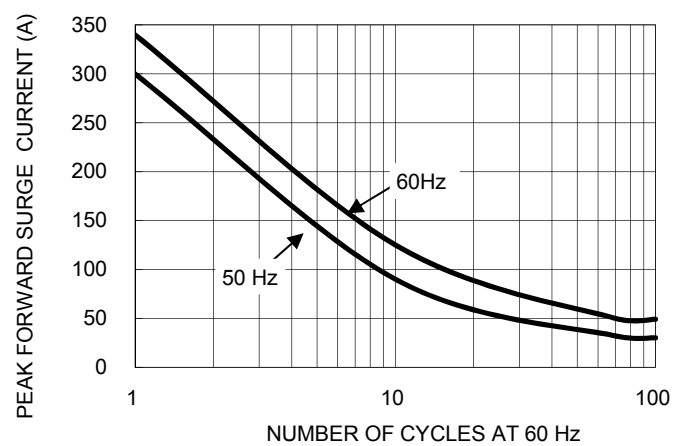

FIG. 3 TYPICAL FORWARD CHARACTERISTICS

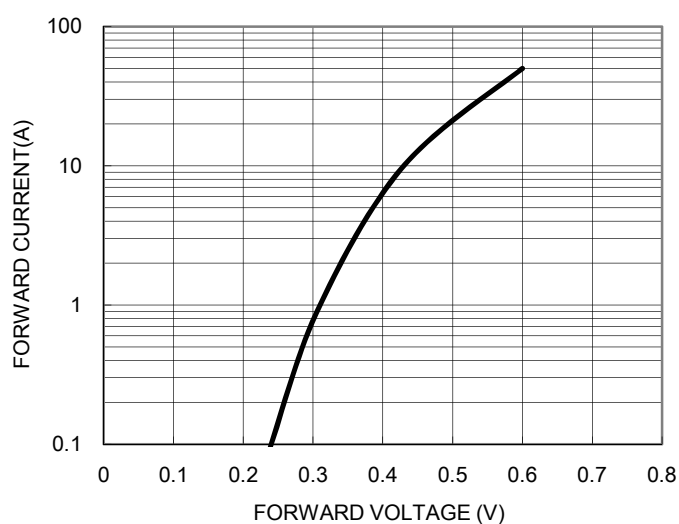

FIG. 4 TYPICAL REVERSE CHARACTERISTICS

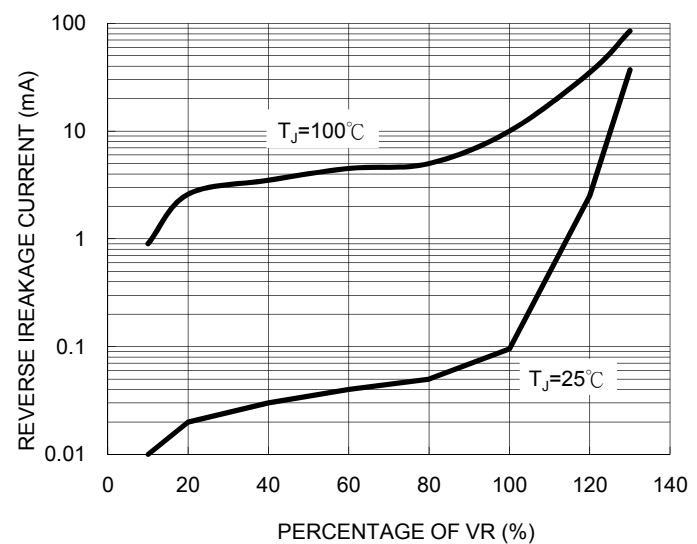

FIG. 5 TYPICAL JUNCTION CAPACITANCE

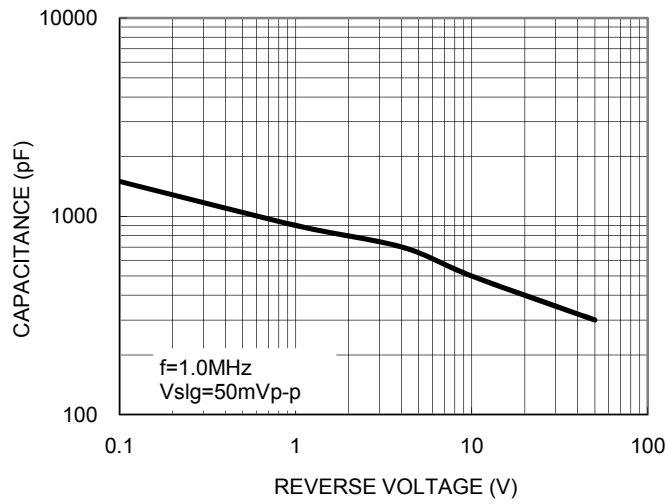
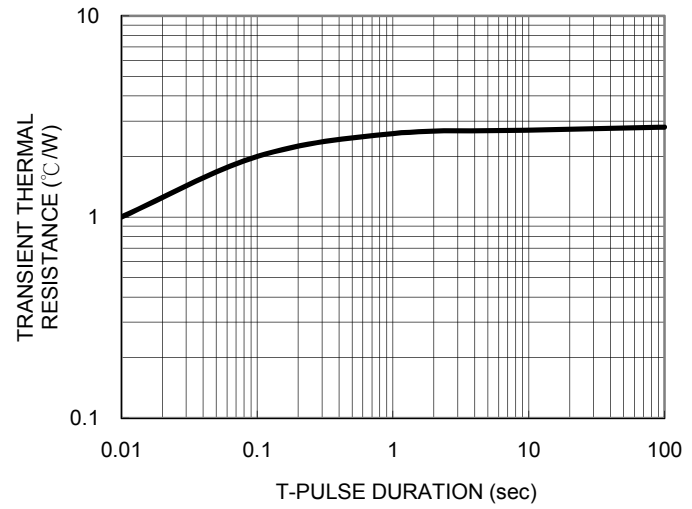
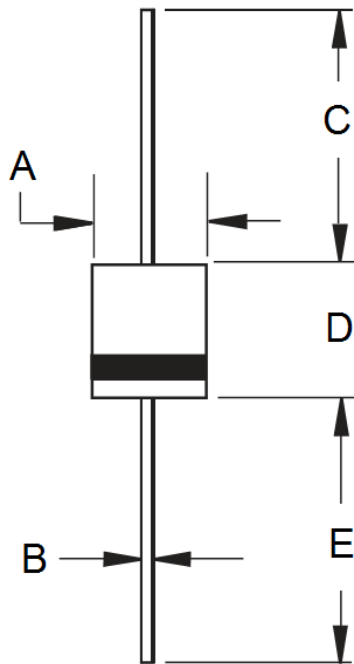

FIG. 6 TYPICAL TRANSIENT THERMAL RESISTANCE



PACKAGE OUTLINE DIMENSIONS



DIM.	Unit (mm)		Unit (inch)	
	Min	Max	Min	Max
A	6.80	7.20	0.268	0.283
B	1.20	1.30	0.047	0.051
C	25.40	-	1.000	-
D	8.60	9.10	0.339	0.358
E	25.40	-	1.000	-

MARKING DIAGRAM



P/N = Specific Device Code
 G = Green Compound
 YWW = Date Code
 F = Factory Code

Notice

Specifications of the products displayed herein are subject to change without notice. TSC or anyone on its behalf, assumes no responsibility or liability for any errors inaccuracies.

Information contained herein is intended to provide a product description only. No license, express or implied, to any intellectual property rights is granted by this document. Except as provided in TSC's terms and conditions of sale for such products, TSC assumes no liability whatsoever, and disclaims any express or implied warranty, relating to sale and/or use of TSC products including liability or warranties relating to fitness for a particular purpose, merchantability, or infringement of any patent, copyright, or other intellectual property right.

The products shown herein are not designed for use in medical, life-saving, or life-sustaining applications. Customers using or selling these products for use in such applications do so at their own risk and agree to fully indemnify TSC for any damages resulting from such improper use or sale.